

DATA BOOK 1990/91



**GENERAL
INSTRUMENT**
POWER SEMICONDUCTOR DIVISION

INTRODUCTION

General Instrument Corporation is a major multinational company manufacturing a wide range of products from data systems, broadband communications, and components to semiconductor products. The corporation, which has been in existence over 50 years, has manufacturing and sales locations throughout the world serving all major electronic markets.

The Power Semiconductor Division has manufacturing facilities in the United States and the Far East and is one of the leading producers of discrete semiconductor devices. These devices include low and medium power rectifiers from standard thru ultrafast recovery, bridge assemblies and transient voltage suppressors. We offer the widest selection of rectifier package types and junction structures including plastic encapsulated, glass passivated, superrectifier, and surface mounted. Advanced junction technologies include double diffusion, double diffused fast recovery, narrow base epitaxial, PAR and Schottky.

Particular emphasis has been focused on the superrectifier product family including our new super surface mounted devices. The superrectifier, when introduced ten years ago increased rectifier reliability by several orders of magnitude. Today it still remains unmatched as the cost performance leader in axial leaded rectifiers. Now the superrectifier features of metallurgically bonded junction, glass passivation, and flame retardant encapsulation are available in our line of super surface mounted rectifiers. For the ultimate in surface mounted rectifier reliability it's super surface mount.

The information contained in this data book is intended to provide the necessary technical and support data to assist the design engineer. It is our policy to maintain high standards of product manufacturing. The General Instrument logo (GI), printed on every component, ensures that it reaches the highest level of quality and reliability. In the complex and competitive semiconductor industry, high standards of quality using the latest methods of statistical quality control are of the utmost importance since they constitute, for our customer the assurance of reliable product performance.

Not every application problem can be solved using a standard device, in this case we often develop special products to meet the customer requirements. If in doubt, call your local Sales Office or our Application Engineering Laboratory for further information.

**GENERAL
INSTRUMENT**

SYMBOLS

C _J	Junction Capacitance	T _J	Junction Temperature
I _F	Forward Current	T _L	Maximum Lead Temperature
I _(AV)	Average Forward Rectifier Current	t _r	Rise Time
I _{FSM}	Peak Forward Surge Current	t _{rr}	Reverse Recovery Time
I _o	Mean Forward Current	V _{BR}	Breakdown Voltage
I _R	Reverse Current	V _F	Forward Voltage
I _{rr}	Reverse Recovery Current	V _{FR}	Forward Recovery Voltage
I _{RSM}	Maximum Non-Repetitive Peak Current	V _R	Reverse Voltage
I _T	On-State Test Current	V _{RM}	Maximum Recurrent Peak Reverse Voltage
I ² _t	Rating for Fusing	V _{RMS}	RMS Input Voltage
P _D	Steady State Power Dissipation	V _{RRM}	Repetitive Peak Reverse Voltage
P _{PK}	Peak Power Dissipation	V _{RSM}	Maximum Reverse Voltage (Clamping Voltage) at I _{RSM}
R _{θJA}	Thermal Resistance (Junction to ambient)	V _{RWM}	Working Peak Reverse Voltage (Stand-off Voltage)
R _{θJC}	Thermal Resistance (Junction to case)	V _Z	Zener Voltage
R _{θJL}	Thermal Resistance (Junction to Lead)	Z _k	Dynamic Impedance
T _A	Ambient Temperature		
T _C	Case Temperature		

DRAWINGS

All dimensions in inches and (millimeters.)
Figures not to scale.

TEMPERATURES

Ratings at 25° C ambient temperature unless
otherwise specified.

The General Instrument data book is not a document
for official acceptance tests. Relevant is only the
detailed data sheet, which is available on request.
The Manufacturer reserves the right to change the contained
data at any time in order to improve performance and supply
the best product possible.

**GENERAL
INSTRUMENT**

CONTENTS

**POWER
SEMICONDUCTOR
DIVISION**

**DATA BOOK
1990/1991**

General Information	
Introduction	1
Symbols	2
Contents	3
Numerical Index	5
Quality Assurance	
Introduction	14
Test Conditions	15
High Reliability-Test Capabilities	16
Military Approved Rectifiers	
Introduction	19
List of approved JAN-JANTX devices	21
JAN, JANTX, JANTXV devices 0.2 to 10.0 AMP	22
Schottky Rectifiers	
Introduction	53
Quick Selector Guide	55
Axial Plastic Schottky Rectifiers 0.6 to 5.0 AMP	59
Medium Current Schottky Rectifiers 5.0 to 40 AMP	79
Fast Efficient Rectifiers	
Introduction	181
Quick Selector Guide	183
Glass Passivated Fast Efficient Rectifiers 1.0 to 6.0 AMP	187
Fast Efficient Superrectifier 1.0 to 5.0 AMP	209
Plastic Fast Efficient Rectifiers 1.0 to 3.0 AMP	219
Medium Current Fast Efficient Rectifiers 6.0 to 30 AMP	225
Superrectifiers	
Introduction	257
Quick Selector Guide	259
Zener Regulator Diode 1.5 Watt	301
Fast Recovery Superrectifiers 0.4 to 3.0 AMP	305
Miniature GPP Plastic Rectifier 1.0 AMP	331
Glass Rectifiers	
Introduction	338
Quick Selector Guide	341
High Voltage Glass Passivated Rectifiers 1.0 to 3.0 AMP	365
Fast Recovery Glass Passivated Rectifiers 1.0 to 3.0 AMP	379
Plastic Rectifiers	
Introduction	402
Quick Selector Guide	405
Plastic Rectifiers 8.0 to 30 AMP	425
Fast Recovery Plastic Rectifiers 1.0 to 30 AMP	437
Bridge Rectifiers	
Introduction	466
Quick Selector Guide	468
Bridge Rectifiers 0.9 to 35 Amps	470
Surface Mounted Bridge Rectifiers 1.0 AMP	523
Surface Mounted Rectifiers	
Introduction	528
Quick Selector Guide	529
Surface Mounted Rectifier 0.5 to 5.0 AMP	532
Transient Voltage Suppressor	
Introduction	561
Application Notes	
Schottky Rectifier	599
Transient Voltage Suppressor	603
Surface Mount Superrectifier	607
Thyristor Surge Suppressor /Transient Voltage Suppressor	611
Standard Rectifiers	615
Transient Voltage Suppressor - Automotive	619
Packaging	
Information	623
Sales Offices and Distributors	
Information	630

**GENERAL
INSTRUMENT**

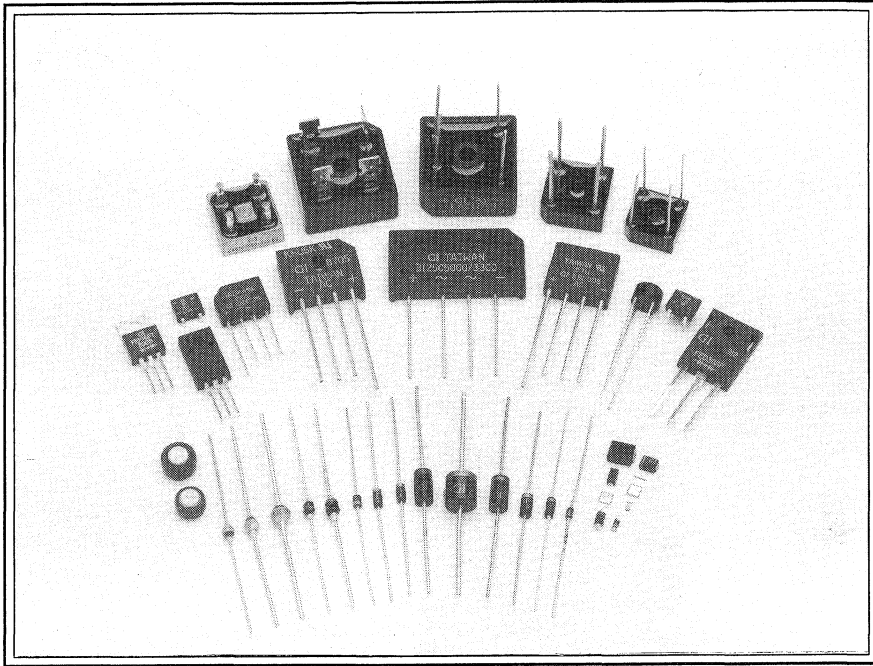

**GENERAL
INSTRUMENT**

NUMERICAL INDEX

1.5KA10	570	1.5KE16A	586	1N3611GP	270	1N4948GP	314
1.5KA10A	570	1.5KE170	586	1N3612GP	270	1N5059	348
1.5KA11	570	1.5KE170A	586	1N3613GP	270	1N5059GP	282
1.5KA11A	570	1.5KE18	586	1N3614GP	270	1N5060	348
1.5KA12	570	1.5KE180	586	1N39576GP	270	1N5060GP	282
1.5KA12A	570	1.5KE180A	586	1N4001	406	1N5061	348
1.5KA13	570	1.5KE18A	586	1N4001GP	272	1N5061GP	282
1.5KA13A	570	1.5KE20	586	1N4001P	408	1N5062	348
1.5KA15	570	1.5KE200	586	1N4002	406	1N5062GP	282
1.5KA15A	570	1.5KE200A	586	1N4002GP	272	1N5391	412
1.5KA16	570	1.5KE20A	586	1N4002P	408	1N5391GP	286
1.5KA16A	570	1.5KE22	586	1N4003	406	1N5392	412
1.5KA18	570	1.5KE220	586	1N4003GP	272	1N5392GP	286
1.5KA18A	570	1.5KE220A	586	1N4003P	408	1N5393	412
1.5KA20	570	1.5KE22A	586	1N4004	406	1N5393GP	286
1.5KA20A	570	1.5KE24	586	1N4004GP	272	1N5394	412
1.5KA22	570	1.5KE24A	586	1N4004P	408	1N5394GP	286
1.5KA22A	570	1.5KE250	586	1N4005	406	1N5395	412
1.5KA24	570	1.5KE250A	586	1N4005GP	272	1N5395GP	286
1.5KA24A	570	1.5KE27	586	1N4005P	408	1N5396	412
1.5KA27	570	1.5KE27A	586	1N4006	406	1N5396GP	286
1.5KA27A	570	1.5KE30	586	1N4006GP	272	1N5397	412
1.5KA30	570	1.5KE300	586	1N4006P	408	1N5397GP	286
1.5KA30A	570	1.5KE300A	586	1N4007	406	1N5398	412
1.5KA33	570	1.5KE30A	586	1N4007GP	272	1N5498GP	286
1.5KA33A	570	1.5KE33	586	1N4007P	408	1N5399	412
1.5KA36	570	1.5KE33A	586	1N4245	346	1N5399GP	286
1.5KA36A	570	1.5KE350	586	1N4245GP	274	1N5400	414
1.5KA39	570	1.5KE350A	586	1N4246	346	1N5401	414
1.5KA39A	570	1.5KE36	586	1N4246GP	274	1N5402	414
1.5KA43	570	1.5KE36A	586	1N4247	346	1N5403	414
1.5KA43A	570	1.5KE39	586	1N4247GP	274	1N5404	414
1.5KA6.8	570	1.5KE39A	586	1N4248	346	1N5405	414
1.5KA6.8A	570	1.5KE40	586	1N4248GP	274	1N5406	414
1.5KA7.5	570	1.5KE400	586	1N4249	346	1N5407	414
1.5KA7.5A	570	1.5KE400A	586	1N4249GP	274	1N5408	414
1.5KA8.2	570	1.5KE40A	586	1N4383GP	280	1N5415	392
1.5KA8.2A	570	1.5KE43	586	1N4384GP	280	1N5416	392
1.5KA9.1	570	1.5KE43A	586	1N4385GP	280	1N5417	392
1.5KA9.1A	570	1.5KE47	586	1N4585GP	280	1N5418	392
1.5KE10	586	1.5KE47A	586	1N4586GP	280	1N5419	392
1.5KE100	586	1.5KE51	586	1N483B	342	1N5420	392
1.5KE100A	586	1.5KE51A	586	1N485B	342	1N5550	356
1.5KE10A	586	1.5KE56	586	1N486B	342	1N5551	356
1.5KE11	586	1.5KE56A	586	1N4933	438	1N5552	356
1.5KE110	586	1.5KE6.8	586	1N4933GP	312	1N5553	356
1.5KE110A	586	1.5KE6.8A	586	1N4934	438	1N5554	356
1.5KE11A	586	1.5KE62	586	1N4934GP	312	1N5614	350
1.5KE12	586	1.5KE62A	586	1N4935	438	1N5615	382
1.5KE120	586	1.5KE68	586	1N4935GP	312	1N5615GP	318
1.5KE120A	586	1.5KE68A	586	1N4936	438	1N5616	350
1.5KE12A	586	1.5KE7.5	586	1N4936GP	312	1N5617	382
1.5KE13	586	1.5KE7.5A	586	1N4937	438	1N5617GP	318
1.5KE130	586	1.5KE75	586	1N4937GP	312	1N5618	350
1.5KE130A	586	1.5KE75A	586	1N4942	380	1N5619	382
1.5KE13A	586	1.5KE8.2	586	1N4942GP	314	1N5619GP	318
1.5KE15	586	1.5KE8.2A	586	1N4944	380	1N5620	350
1.5KE150	586	1.5KE82	586	1N4944GP	314	1N5621	382
1.5KE150A	586	1.5KE82A	586	1N4946	380	1N5621GP	318
1.5KE15A	586	1.5KE9.1	586	1N4946GP	314	1N5622	350
1.5KE16	586	1.5KE9.1A	586	1N4947	380	1N5623	382
1.5KE160	586	1.5KE91	586	1N4947GP	314	1N5623GP	318
1.5KE160A	586	1.5KE91A	586	1N4948	380	1N5624	358

NUMERICAL INDEX

1N5624GP	296	1N6289A	586	3N259	492	5KP7.0	590
1N5625	358	1N6290	586	5KP10	590	5KP7.0A	590
1N5625GP	296	1N6290A	586	5KP100	590	5KP7.5	590
1N5626	358	1N6291	586	5KP100A	590	5KP7.5A	590
1N5626GP	296	1N6291A	586	5KP10A	590	5KP7.0	590
1N5627	358	1N6292	586	5KP11	590	5KP70A	590
1N5627GP	296	1N6292A	586	5KP110	590	5KP75	590
1N5817	62	1N6293	586	5KP110A	590	5KP75A	590
1N5818	62	1N6293A	586	5KP11A	590	5KP78	590
1N5819	62	1N6294	586	5KP12	590	5KP78A	590
1N5820	68	1N6294A	586	5KP12A	590	5KP8.0	590
1N5821	68	1N6295	586	5KP13	590	5KP8.0A	590
1N5822	68	1N6295A	586	5KP13A	590	5KP8.5	590
1N645	344	1N6296	586	5KP14	590	5KP8.5A	590
1N646	344	1N6296A	586	5KP14A	590	5KP85	590
1N647	344	1N6297	586	5KP15	590	5KP85A	590
1N648	344	1N6297A	586	5KP15A	590	5KP9.0	590
1N649	344	1N6298	586	5KP16	590	5KP9.0A	590
1N6267	586	1N6298A	586	5KP16A	590	5KP90	590
1N6267A	586	1N6299	586	5KP17	590	5KP90A	590
1N6268	586	1N6299A	586	5KP17A	590	AGP15-200	290
1N6268A	586	1N6300	586	5KP18	590	AGP15-400	290
1N6269	586	1N6300A	586	5KP18A	590	AGP15-600	290
1N6269A	586	1N6301	586	5KP20	590	AGP15-800	290
1N6270	586	1N6301A	586	5KP20A	590	AR25A	434
1N6270A	586	1N6302	586	5KP22	590	AR25B	434
1N6271	586	1N6302A	586	5KP22A	590	AR25D	434
1N6271A	586	1N6303	586	5KP24	590	AR25G	434
1N6272	586	1N6303A	586	5KP24A	590	AR25J	434
1N6272A	586	1N6478	538	5KP26	590	AR25K	434
1N6273	586	1N6479	538	5KP26A	590	AR25M	434
1N6273A	586	1N6480	538	5KP28	590	ARS25A	434
1N6274	586	1N6481	538	5KP28A	590	ARS25B	434
1N6274A	586	1N6482	538	5KP30	590	ARS25D	434
1N6275	586	1N6483	538	5KP30A	590	ARS25G	434
1N6275A	586	1N6484	538	5KP33	590	ARS25J	434
1N6276	586	2KBP005M	492	5KP33A	590	ARS25K	434
1N6276A	586	2KBP01M	492	5KP36	590	ARS25M	434
1N6277	586	2KBP02M	492	5KP36A	590	AW02G	486
1N6277A	586	2KBP04M	492	5KP40	590	AW02M	484
1N6278	586	2KBP06M	492	5KP40A	590	AW04G	486
1N6278A	586	2KBP08M	492	5KP43	590	AW04M	484
1N6279	586	2KBP10M	492	5KP43A	590	AW06G	486
1N6279A	586	2W005M	490	5KP45	590	AW06M	484
1N6280	586	2W01M	490	5KP45A	590	AW08G	486
1N6280A	586	2W02M	490	5KP48	590	AW08M	484
1N6281	586	2W04M	490	5KP48A	590	B125C1000M	476
1N6281A	586	2W06M	490	5KP5.0	590	B125C1500M	488
1N6282	586	2W08M	490	5KP5.0A	590	B125C3700/2200	496
1N6282A	586	2W10M	490	5KP51	590	B125C5000/3300	502
1N6283	586	3N246	482	5KP51A	590	B125C800M	470
1N6283A	586	3N247	482	5KP54	590	B125C800DM	472
1N6284	586	3N248	482	5KP54A	590	B250C1000M	476
1N6284A	586	3N249	482	5KP58	590	B250C1500M	488
1N6285	586	3N250	482	5KP58A	590	B250C3700/2200	496
1N6285A	586	3N251	482	5KP6.0	590	B250C5000/3300	502
1N6286	586	3N252	482	5KP6.0A	590	B250C800M	470
1N6286A	586	3N253	492	5KP6.5	590	B250C800DM	472
1N6287	586	3N254	492	5KP6.5A	590	B380C1000M	476
1N6287A	586	3N255	492	5KP60	590	B380C1500M	488
1N6288	586	3N256	492	5KP60A	590	B380C3700/2200	496
1N6288A	586	3N257	492	5KP64	590	B380C5000/3300	502
1N6289	586	3N258	492	5KP64A	590	B380C800M	470

**GENERAL
INSTRUMENT**

NUMERICAL INDEX

B380C800DM	472	BYM10A-800	540	BZW04-111	578	BZW04P28	578
B40C1000M	476	BYM11-100	542	BZW04-128	578	BZW04P299	578
B40C1500M	488	BYM11-1000	542	BZW04-13	578	BZW04P31	578
B40C3700/2200	496	BYM11-200	542	BZW04-136	578	BZW04-33	578
B40C5000/3300	502	BYM11-400	542	BZW04-14	578	BZW04P342	578
B40C1000M	476	BYM11-50	542	BZW04-145	578	BZW04P37	578
B40C800M	470	BYM11-600	542	BZW04-15	578	BZW04P376	578
B40C800DM	472	BYM11-800	542	BZW04-154	578	BZW04P40	578
B80C1500M	488	BYM12-100	544	BZW04-17	578	BZW04P44	578
B80C3700/2200	496	BYM12-150	544	BZW04-171	578	BZW04P48	578
B80C5000/3300	502	BYM12-200	544	BZW04-188	578	BZW04P53	578
B80C800M	470	BYM12-300	544	BZW04-19	578	BZW04P58	578
B80C800DM	472	BYM12-400	544	BZW04-20	578	BZW04P5V8	578
BA157GP	310	BYM12-50	544	BZW04-213	578	BZW04P64	578
BA158GP	310	BYM13-20	550	BZW04-23	578	BZW04P70	578
BA159DGP	310	BYM13-30	550	BZW04-239	578	BZW04P78	578
BY159GP	310	BYM13-40	550	BZW04-256	578	BZW04P7V0	578
BY126MGP	294	BYM13-50	550	BZW04-26	578	BZW04P7V8	578
BA127MGP	294	BYM13-60	550	BZW04-273	578	BZW04P85	578
BY133GP	284	BYV27-100	194	BZW04-28	578	BZW04P8V4	578
BY134GP	284	BY27-150	194	BZW04-299	578	BZW04P8V5	578
BY135GP	284	BYV27-200	194	BZW04-31	578	BZW04P94	578
BY206GP	308	BYV27-50	194	BZW04-33	578	BZW04P9V4	578
BY207GP	308	BYV28-50	200	BZW04-342	578	CG1	366
BY226MGP	294	BYV28-100	200	BZW04-37	578	CG2	372
BY227MGP	294	BYV28-150	200	BZW04-376	578	CG3	376
BY228	374	BYV28-200	200	BZW04-40	578	DF005M	474
BY296P	444	BYV32-50	248	BZW04-44	578	DF005S	524
BY297P	444	BYV32-100	248	BZW04-48	578	DF01M	474
BY298P	444	BYV32-150	248	BZW04-53	578	DF01S	524
BY299P	444	BYV32-200	248	BZW04-58	578	DF02M	474
BY396P	452	BYV95A	386	BZW04-5V8	578	DF02S	524
BY397P	452	BYV95B	386	BZW04-64	578	DF04M	474
BY398P	452	BYV95C	386	BZW04-6V4	578	DF04S	524
BY399P	452	BYV96D	386	BZW04-70	578	DF06M	474
BY448	370	BYV96E	386	BZW04-78	578	DF06S	524
BY458	370	BYW27-100GP	278	BZW04-7V0	578	DF08M	474
BY500-100	454	BYW27-1000GP	278	BZW04-7V8	578	DF08S	524
BY500-200	454	BYW27-200GP	278	BZW04-85	578	DF10M	474
BY500-400	454	BYW27-400GP	278	BZW04-8V5	578	DF10S	524
BY500-600	454	BYW27-50GP	278	BZW04-94	578	DG1	366
BYM05-100	532	BYW27-600GP	278	BZW04P10	578	DG2	372
BYM05-200	532	BYW27-800GP	278	BZW04P102	578	DG3	376
BYM05-400	532	BYW29-50	236	BZW04P11	578	EDF1AM	520
BYM05-500	532	BYW29-100	236	BZW04P111	578	EDF1BM	520
BYM05-600	532	BYW29-150	236	BZW04P128	578	EDF1CM	520
BYM06-100	534	BYW29-200	236	BZW04P13	578	EDF1DM	520
BYM06-200	534	BYW32	390	BZW04P136	578	EGL34A	536
BYM06-400	534	BYW33	390	BZW04P14	578	EGL34B	536
BYM06-50	534	BYW34	390	BZW04P145	578	EGL34C	536
BYM06-600	534	BYW35	390	BZW04P15	578	EGL34D	536
BYM07-100	536	BYW36	390	BZW04P154	578	EGL34F	536
BYM07-150	536	BYW72	398	BZW04P17	578	EGL34G	536
BYM07-200	536	BYW73	398	BZW04P171	578	EGL41A	544
BYM07-300	536	BYW74	398	BZW04P188	578	EGL41B	544
BYM07-400	536	BYW75	398	BZW04P19	578	EGL41C	544
BYM07-50	536	BYW76	398	BZW04P20	578	EGL41D	544
BYM10A-100	540	BYX10GP	266	BZW04P213	578	EGL41F	544
BYM10-1000	540	BYX55-350P	442	BZW04P23	578	EGL41G	544
BYM10-200	540	BYX55-600P	442	BZW04P239	578	EGP10A	210
BYM10-400	540	BZW04-10	578	BZW04P256	578	EGP10B	210
BYM10-50	540	BZW04-102	578	BZW04P26	578	EGP10C	210
BYM10-600	540	BZW04-11	578	BZW04P273	578	EGP10D	210

NUMERICAL INDEX

EGP10F	210	FEPF30DP	250	G3A	360	GI822	456
EGP10G	210	FEPF30FP	250	G3B	360	GI824	456
EGP20A	212	FEPF30GP	250	G3D	360	GI826	456
EGP20B	212	FEPF30HP	250	G3G	360	GI850	446
EGP20C	212	FEPF30JP	250	G3J	360	GI851	446
EGP20D	212	FEPF6AT	226	G3K	360	GI852	446
EGP20F	212	FEPF6BT	226	G3M	360	GI854	446
EGP20G	212	FEPF6CT	226	G4A	362	GI856	446
EGP30A	214	FEPF6DT	226	G4B	362	GI910	448
EGP30B	214	FEP30AP	252	G4D	362	GI911	448
EGP30C	214	FEP30BP	252	G4G	362	GI912	448
EGP30D	214	FEP30CP	252	G4J	362	GI914	448
EGP30F	214	FEP30DP	252	G4K	362	GI916	448
EGP30G	214	FEP30FP	252	G4M	362	GI917	448
EGP50A	216	FEP30GP	252	GI1-1200	368	GL34A	532
EGP50B	216	FEP30HP	252	GI1-1400	368	GL34B	532
EGP50C	216	FEP30JP	252	GI1-1600	368	GL34D	532
EGP50D	216	FES8AT	232	GI1001	190	GL34G	532
EGP50F	216	FES8BT	232	GI1002	190	GL34J	532
EGP50G	216	FES8CT	232	GI1003	190	GL34K	532
FE1A	188	FES8DT	232	GI1004	190	GL41A	540
FE1B	188	FES8FT	232	GI1101	196	GL41B	540
FE1C	188	FES8GT	232	GI1102	196	GL41D	540
FE1D	188	FES8HT	232	GI1103	196	GL41G	540
FE2A	192	FES8JT	232	GI1104	196	GL41J	540
FE2B	192	FES16AT	240	GI1301	206	GL41K	540
FE2C	192	FES16BT	240	GI1302	206	GL41M	540
FE2D	192	FES16CT	240	GI1303	206	GLL4735	546
FE3A	198	FES16DT	240	GI1304	206	GLL4736	546
FE3B	198	FES16FT	240	GI1401	234	GLL4737	546
FE3C	198	FES16GT	240	GI1402	234	GLL4738	546
FE3D	198	FES16HT	240	GI1403	234	GLL4739	546
FE5A	202	FES16JT	240	GI1404	234	GLL4740	546
FE5B	202	FESF8AT	230	GI2401	246	GLL4741	546
FE5C	202	FESF8BT	230	GI2402	246	GLL4742	546
FE5D	202	FESF8CT	230	GI2403	246	GLL4743	546
FE6A	204	FESF8DT	230	GI2404	246	GLL4744	546
FE6B	204	FESF8FT	230	GI250-1	264	GLL4745	546
FE6C	204	FESF8GT	230	GI250-2	264	GLL4746	546
FE6D	204	FESF8HT	230	GI250-3	264	GLL4747	546
FEP16AT	244	FESF8JT	230	GI250-4	264	GLL4748	546
FEP16BT	244	FESF16AT	238	GI500	416	GLL4749	546
FEP16CT	244	FESF16BT	238	GI501	416	GLL4750	546
FEP16DT	244	FESF16CT	238	GI502	416	GLL4751	546
FEP16FT	244	FESF16DT	238	GI504	416	GLL4752	546
FEP16GT	244	FESF16FT	238	GI506	416	GLL4753	546
FEP16HT	244	FESF16GT	238	GI508	416	GLL4754	546
FEP16JT	244	FESF16HT	238	GI510	416	GLL4755	546
FEP6AT	228	FESF16JT	238	GI750	420	GLL4756	546
FEP6BT	228	G1A	352	GI751	420	GLL4757	546
FEP6CT	228	G1B	352	GI752	420	GLL4758	546
FEP6DT	228	G1D	352	GI754	420	GLL4759	546
FEPF16AT	242	G1G	352	GI756	420	GLL4760	546
FEPF16BT	242	G1J	352	GI758	420	GLL4761	546
FEPF16CT	242	G1K	352	GI810	320	GLL4762	546
FEPF16DT	242	G1M	352	GI811	320	GLL4763	546
FEPF16FT	242	G2A	354	GI812	320	GP02-20	262
FEPF16GT	242	G2B	354	GI814	320	GP02-25	262
FEPF16HT	242	G2D	354	GI816	320	GP02-30	262
FEPF16JT	242	G2G	354	GI817	320	GP02-35	262
FEPF30AP	250	G2J	354	GI818	320	GP02-40	262
FEPF30BP	250	G2K	354	GI820	456	GP08A	268
FEPF30CP	250	G2M	354	GI821	456	GP08B	268

**GENERAL
INSTRUMENT**

NUMERICAL INDEX

GP08D	268	J,JTX1N4248	28	J,JTX1N6120 A	50	KBPC15-08W	512
GP08G	268	J,JTX1N4249	28	J,JTX1N6121A	50	KBPC15-10	512
GP08J	268	J,JTX1N4942	30	J,JTX1N6122A	50	KBPC15-10W	512
GP10A	276	J,JTX1N4944	30	J,JTX1N6123A	50	KBPC25-005	512
GP10B	276	J,JTX1N4946	30	J,JTX1N6124A	50	KBPC25-005W	512
GP10D	276	J,JTX1N4947	30	J,JTX1N6125A	50	KBPC25-01	512
GP10G	276	J,JTX1N4948	30	J,JTX1N6126A	50	KBPC25-01W	512
GP10J	276	J,JTX1N5415	32	J,JTX1N6127A	50	KBPC2502	512
GP10K	276	J,JTX1N5416	32	J,JTX1N6128A	50	KBPC2502W	512
GP10M	276	J,JTX1N5417	32	J,JTX1N6129A	50	KBPC2504	512
GP10N	276	J,JTX1N5418	32	J,JTX1N6130A	50	KBPC2504W	512
GP10Q	276	J,JTX1N5419	32	J,JTX1N645	24	KBPC2506	512
GP10T	276	J,JTX1N5420	32	J,JTX1N647	24	KBPC2506W	512
GP10V	276	J,JTX1N5550	34	J,JTX1N649	24	KBPC2508	512
GP10W	276	J,JTX1N5551	34	J,JTX1N645-1	24	KBPC2508W	512
GP10Y	276	J,JTX1N5552	34	J,JTX1N647-1	24	KBPC2510	512
GP15A	288	J,JTX1N5553	34	J,JTX1N649-1	24	KBPC2510W	512
GP15B	288	J,JTX1N5554	34	KBL005	498	KBPC35005	512
GP15D	288	J,JTX1N5614	38	KBL01	498	KBPC35005W	512
GP15G	288	J,JTX1N5615	36	KBL02	498	KBPC3501	512
GP15J	288	J,JTX1N5616	38	KBL04	498	KBPC3501W	512
GP15K	288	J,JTX1N5617	36	KBL06	498	KBPC3502	512
GP15M	288	J,JTX1N5618	38	KBL08	498	KBPC3502W	512
GP20A	292	J,JTX1N5619	36	KBL10	498	KBPC3504	512
GP20B	292	J,JTX1N5620	38	KBP005M	482	KBPC3504W	512
GP20D	292	J,JTX1N5621	36	KBP01M	482	KBPC3506	512
GP20G	292	J,JTX1N5622	38	KBP02M	482	KBPC3506W	512
GP20J	292	J,JTX1N5623	36	KBP04M	482	KBPC3508	512
GP30A	298	J,JTX1N5624	40	KBP06M	482	KBPC3508W	512
GP30B	298	J,JTX1N5625	40	KBP08M	482	KBPC3510	512
GP30D	298	J,JTX1N5626	40	KBP10M	482	KBPC3510W	512
GP30G	298	J,JTX1N5627	40	KBPC1005	494	KBPC6005	506
GP30J	298	J,JTXV1N5802	42	KBPC101	494	KBPC601	506
GP30K	298	J,JTXV1N5804	42	KBPC102	494	KBPC602	506
GP30M	298	J,JTXV1N5806	42	KBPC104	494	KBPC604	506
GPP1A	556	J,JTXV1N5807	44	KBPC106	494	KBPC606	506
GPP1B	556	J,JTXV1N5809	44	KBPC108	494	KBPC608	506
GPP1D	556	J,JTXV1N5811	44	KBPC110	494	KBPC610	506
GPP1G	556	J,JTX1N6113	48	KBPC10-005	512	KBPC8005	508
GPP1J	556	J,JTX1N6114	48	KBPC10-005W	512	KBPC801	508
GPP1K	556	J,JTX1N6115	48	KBPC10-01	512	KBPC802	508
GPP1M	556	J,JTX1N6116	48	KBPC10-01W	512	KBPC804	508
GPP5A	556	J,JTX1N6117	48	KBPC10-02	512	KBPC806	508
GPP5B	556	J,JTX1N6118	48	KBPC10-02W	512	KBPC808	508
GPP5D	556	J,JTX1N6119	48	KBPC10-04	512	KBPC810	508
GPP5G	556	J,JTX1N6120	48	KBPC10-04W	512	KBU4A	500
GPP5J	556	J,JTX1N6121	48	KBPC10-06	512	KBU4B	500
GPP5K	556	J,JTX1N6122	48	KBPC10-06W	512	KBU4D	500
J,JTX1N3611	26	J,JTX1N6123	48	KBPC10-08	512	KBU4G	500
J,JTX1N3612	26	J,JTX1N6124	48	KBPC10-08W	512	KBU4J	500
J,JTX1N3613	26	J,JTX1N6125	48	KBPC10-10	512	KBU4K	500
J,JTX1N3614	26	J,JTX4N6126	48	KBPC10-10W	512	KBU4M	500
J,JTX1N3957	26	J,JTX1N6127	48	KBPC15-005	512	KBU6A	504
J,JTX1N483B	22	J,JTX1N6128	48	KBPC15-005W	512	KBU6B	504
J,JTX1N485B	22	J,JTX1N6129	48	KBPC15-01	512	KBU6D	504
J,JTX1N486B	22	J,JTX1N6130	48	KBPC15-01W	512	KBU6G	504
J,JTXM19500/469-01	46	J,JTX1N6113A	50	KBPC15-02	512	KBU6J	504
J,JTXM19500/469-02	46	J,JTX1N6114A	50	KBPC15-02W	512	KBU6K	504
J,JTXM19500/469-03	46	J,JTX1N6115A	50	KBPC15-04	512	KBU6M	504
J,JTXM19500/469-04	46	J,JTX1N6116A	50	KBPC15-04W	512	KBU8A	510
J,JTX1N4245	28	J,JTX1N6117A	50	KBPC15-06	512	KBU8B	510
J,JTX1N4246	28	J,JTX1N6118A	50	KBPC15-06W	512	KBU8D	510
J,JTX1N4247	28	J,JTX1N6119A	50	KBPC15-08	512	KBU8G	510

NUMERICAL INDEX

KBU8J	510	MBRF2060CT	136	P4KA7.5	562	P4KE180	574
KBU8K	510	MBRF2090CT	144	P4KA7.5A	562	P4KE180A	574
KBU8M	510	MBRF20100CT	138	P4KA8.2	562	P4KE18A	574
M100A	410	MBRF2535CT	150	P4KA8.2A	562	P4KE20	574
M100B	410	MBRF2545CT	150	P4KA9.1	562	P4KE200	574
M100D	410	MBRF2550CT	152	P4KA9.1A	562	P4KE200A	574
M100G	410	MBRF2560CT	152	P4KA10	562	P4KE20A	574
M100J	410	MBRF3035PT	158	P4KA10A	562	P4KE22	574
M100K	410	MBRF3045PT	158	P4KA11	562	P4KE220	574
M100M	410	MBRF3050PT	160	P4KA11A	562	P4KE220A	574
MBR1035	100	MBRF3060PT	160	P4KA12	562	P4KE22A	574
MBR1045	100	MBRF4035PT	172	P4KA12A	562	P4KE24	574
MBR1050	102	MBRF4045PT	172	P4KA13	562	P4KE24A	574
MBR1060	102	MBRF4050PT	174	P4KA13A	562	P4KE250	574
MBR1090	104	MBRF4060PT	174	P4KA15	562	P4KE250A	574
MBR10100	104	MBRF735	86	P4KA15A	562	P4KE27	574
MBR1535CT	118	MBRF745	86	P4KA16	562	P4KE27A	574
MBR1545CT	118	MBRF750	88	P4KA16A	562	P4KE30	574
MBR1550CT	120	MBRF760	88	P4KA18	562	P4KE300	574
MBR1560CT	120	MPG06A	332	P4KA18A	562	P4KE300A	574
MBR1635	126	MPG06B	332	P4KA20	562	P4KE30A	574
MBR1645	126	MPG06D	332	P4KA20A	562	P4KE33	574
MBR1650	128	MPG06G	332	P4KA22	562	P4KE33A	574
MBR1680	128	MPG06J	332	P4KA22A	562	P4KE350	574
MBR2035CT	140	MPG06K	332	P4KA24	562	P4KE350A	574
MBR2045CT	140	MPG06M	332	P4KA24A	562	P4KE36	574
MBR2050CT	142	NP16AT	432	P4KA27	562	P4KE36A	574
MBR2060CT	142	NP16BT	432	P4KA27A	562	P4KE39	574
MBR2090CT	144	NP16DT	432	P4KA30	562	P4KE39A	574
MBR20100CT	144	NP16GT	432	P4KA30A	562	P4KE400	574
MBR2535CT	154	NP16JT	432	P4KA33	562	P4KE400A	574
MBR2545CT	154	NP16KT	432	P4KA33A	562	P4KE43	574
MBR2550CT	152	NP16MT	432	P4KA36	562	P4KE43A	574
MBR2560CT	152	NPF16AT	430	P4KA36A	562	P4KE47	574
MBR3035PT	162	NPF16BT	430	P4KA39	562	P4KE47A	574
MBR3045PT	162	NPF16DT	430	P4KA39A	562	P4KE51	574
MBR3050PT	164	NPF16GT	430	P4KA43	562	P4KE51A	574
MBR3060PT	164	NPF16JT	430	P4KA43A	562	P4KE56	574
MBR4035PT	176	NPF16KT	430	P4KE10	574	P4KE56A	574
MBR4045PT	176	NPF16MT	430	P4KE100	574	P4KE6.8	574
MBR4050PT	178	NS8AT	428	P4KE100A	574	P4KE6.8A	574
MBR4060PT	178	NS8BT	428	P4KE10A	574	P4KE62	574
MBR735	90	NS8DT	428	P4KE11	574	P4KE62A	574
MBR745	90	NS8GT	428	P4KE110	574	P4KE68	574
MBR750	92	NS8JT	428	P4KE110A	574	P4KE68A	574
MBR760	92	NS8KT	428	P4KE11A	574	P4KE7.5	574
MBRF1035	94	NS8MT	428	P4KE12	574	P4KE7.5A	574
MBRF1045	94	NSF8AT	426	P4KE120	574	P4KE75	574
MBRF1050	96	NSF8BT	426	P4KE120A	574	P4KE75A	574
MBRF1060	96	NSF8DT	426	P4KE12A	574	P4KE8.2A	574
MBRF1090	98	NSF8GT	426	P4KE13	574	P4KE82	574
MBRF10100	98	NSF8JT	426	P4KE130	574	P4KE82A	574
MBRF1535CT	114	NSF8KT	426	P4KE130A	574	P4KE9.1	574
MBR1545CT	114	NSF8MT	426	P4KE13A	574	P4KE9.1A	574
MBRF1550CT	116	P300A	418	P4KE15	574	P4KE91A	574
MBRF1560CT	116	P300B	418	P4KE150	574	P600A	422
MBRF1635	122	P300D	418	P4KE150A	574	P600B	422
MBRF1645	122	P300G	418	P4KE15A	574	P600D	422
MBRF1650	124	P300J	418	P4KE16	574	P600G	422
MBRF1660	124	P300K	418	P4KE160	574	P600J	422
MBRF2035CT	134	P300M	418	P4KE160A	574	P600K	422
MBRF2045CT	134	P4KA6.8	562	P4KE16A	574	P600M	422
MBRF2050CT	136	P4KA6.8A	562	P4KE18	574	P6KA6.8	566

**GENERAL
INSTRUMENT**

NUMERICAL INDEX

P6KA6.8A	566	P6KE170	582	RG1G	384	RG25D	326
P6KA7.5	566	P6KE170A	582	RG1J	384	RG25G	326
P6KA7.5A	566	P6KE18	582	RG1K	384	RG25J	326
P6KA8.2	566	P6KE180	582	RG1M	384	RG25K	326
P6KA8.2A	566	P6KE180A	582	RG2A	388	RG25M	326
P6KA9.1	566	P6KE18A	582	RG2B	388	RG25P	328
P6KA9.1A	566	P6KE20	582	RG2D	388	RG25R	328
P6KA10	566	P6KE200	582	RG2G	388	RG25S	328
P6KA10A	566	P6KE200A	582	RG2J	388	RG25T	328
P6KA11	566	P6KE20A	582	RG2K	388	RG25U	328
P6KA11A	566	P6KE22	582	RG2M	388	RG25V	328
P6KA12	566	P6KE22A	582	RG3A	394	RG25W	328
P6KA12A	566	P6KE24	582	RG3B	394	RG25X	328
P6KA13	566	P6KE24A	582	RG3D	394	RG25Y	328
P6KA13A	566	P6KE27	582	RG3G	394	RG25Z	328
P6KA15	566	P6KE27A	582	RG3J	394	RG26A	328
P6KA15A	566	P6KE30	582	RG3K	394	RG26B	328
P6KA16	566	P6KR300	582	RG3M	394	RG26C	328
P6KA16A	566	P6KE300A	582	RG4A	396	RG26D	328
P6KA18	566	P6KE30A	582	RG4B	396	RG26E	328
P6KA18A	566	P6KE33	582	RG4D	396	RG26F	328
P6KA20	566	P6KE33A	582	RG4G	396	RG26G	328
P6KA20A	566	P6KE36	582	RG4J	396	RG26H	328
P6KA22	566	P6KE36A	582	RG4K	396	RG26I	328
P6KA22A	566	P6KE39	582	RG4M	396	RG26J	328
P6KA24	566	P6KE39A	582	RGL34A	534	RG26K	328
P6KA24A	566	P6KE400	582	RGL34B	534	RG26L	328
P6KA27	566	P6KE400A	582	RGL34D	534	RG26M	328
P6KA27A	566	P6KE43	582	RGL34G	534	RG26N	328
P6KA30	566	P6KE43A	582	RGL34J	534	RG26O	328
P6KA30A	566	P6KE47	582	RGL41A	542	RG26P	328
P6KA33	566	P6KE47A	582	RGL41B	542	RG26Q	328
P6KA33A	566	P6KE51	582	RGL41D	542	RG26R	328
P6KA36	566	P6KE51A	582	RGL41G	542	RG26S	328
P6KA36A	566	P6KE56	582	RGL41J	542	RG26T	328
P6KA39	566	P6KE56A	582	RGL41K	542	RG26U	328
P6KA39A	566	P6KE6.8	582	RGL41M	542	RG26V	328
P6KA43	566	P6KE6.8A	582	RG26W	306	RG26X	328
P6KA43A	566	P6KE62	582	RG26Y	306	RG26Z	328
P6KE10	582	P6KE62A	582	RG27A	306	RG27B	328
P6KE100	582	P6KE68	582	RG27C	306	RG27D	328
P6KE100A	582	P6KE68A	582	RG27E	306	RG27F	328
P6KE10A	582	P6KE7.5	582	RG27G	316	RG27H	328
P6KE11	582	P6KE7.5A	582	RG27I	316	RG27J	328
P6KE110	582	P6KE75	582	RG27K	316	RG27L	328
P6KE110A	582	P6KE75A	582	RG27M	316	RG27N	328
P6KE11A	582	P6KE8.2	582	RG27O	316	RG27P	328
P6KE12	582	P6KE8.2A	582	RG27Q	316	RG27R	328
P6KE120	582	P6KE82	582	RG27S	316	RG27T	328
P6KE120A	582	P6KE82A	582	RG27U	322	RG27V	328
P6KE12A	582	P6KE9.1	582	RG27W	322	RG27X	328
P6KE13	582	P6KE9.1A	582	RG27Y	322	RG27Z	328
P6KE130	582	P6KE91	582	RG28A	322	RG28B	328
P6KE130A	582	P6KE91A	582	RG28C	322	RG28D	328
P6KE13A	582	RDF005M	516	RG28E	322	RG28F	328
P6KE15	582	RDF01M	516	RG28G	322	RG28H	328
P6KE150	582	RDF02M	516	RG28I	324	RG28J	328
P6KE150A	582	RDF04M	516	RG28K	324	RG28L	328
P6KE15A	582	RDF06M	516	RG28M	324	RG28N	328
P6KE16	582	RDF08M	516	RG28O	324	RG28P	328
P6KE160	582	RG1A	384	RG28Q	324	RG28R	328
P6KE160A	582	RG1B	384	RG28S	324	RG28T	328
P6KE16A	582	RG1D	384	RG28U	326	RG28V	328

NUMERICAL INDEX

SB360	70	TGL41-10A	552	TGL41-8.2	552	ZGP10-110	302
SB390	72	TGL41-11	552	TGL41-8.2A	552	ZGP10-110A	302
SB3100	72	TGL41-110	552	TGL41-82	552	ZGP10-110B	302
SB520	74	TGL41-110A	552	TGL41-82A	552	ZGP10-120	302
SB530	74	TGL41-11A	552	TGL41-9.1	552	ZGP10-120A	302
SB540	74	TGL41-12	552	TGL41-9.1A	552	ZGP10-120B	302
SB550	74	TGL41-120	552	TGL41-91	552	ZGP10-130	302
SB560	74	TGL41-120A	552	TGL41-91A	552	ZGP10-130A	302
SB590	76	TGL41-12A	552	UF4001	220	ZGP10-130B	302
SB5100	76	TGL41-13	552	UF4002	220	ZGP10-140	302
SBL1030	108	TGL41-130	552	UF4003	220	ZGP10-140A	302
SBL1040	108	TGL41-130A	552	UF4004	220	ZGP10-140B	302
SBL1030CT	112	TGL41-13A	552	UF4005	220	ZGP10-150	302
SBL1040CT	112	TGL41-15	552	UF4006	220	ZGP10-150A	302
SBL1630CT	132	TGL41-150	552	UF4007	220	ZGP10-150B	302
SBL1640CT	132	TGL41-150A	552	UF5400	222	ZGP10-160	302
SBL2030PT	148	TGL41-15A	552	UF5401	222	ZGP10-160A	302
SBL2040PT	148	TGL41-16	552	UF5402	222	ZGP10-160B	302
SBLF3030PT	166	TGL41-160	552	UF5403	222	ZGP10-170	302
SBLF3040PT	166	TGL41-160A	552	UF5404	222	ZGP10-170A	302
SBL530	82	TGL41-16A	552	UF5405	222	ZGP10-170B	302
SBL540	82	TGL41-170	552	UF5406	222	ZGP10-180	302
SBLF1030	106	TGL41-170A	552	UF5407	222	ZGP10-180A	302
SBLF1040	106	TGL41-18	552	UF5408	222	ZGP10-180B	302
SBLF1030CT	110	TGL41-180	552	W005G	480	ZGP10-190	302
SBLF1040CT	110	TGL41-180A	552	W01G	480	ZGP10-190A	302
SBLF1630CT	130	TGL41-18A	552	W02G	480	ZGP10-190B	302
SBLF1640CT	130	TGL41-20	552	W04G	480	ZGP10-200	302
SBLF2030PT	146	TGL41-200	552	W06G	480	ZGP10-200A	302
SBLF2040PT	146	TGL41-200A	552	W08G	480	ZGP10-200B	302
SBLF3030PT	166	TGL41-20A	552	W10G	480		
SBLF3040PT	166	TGL41-22	552	W005M	478		
SBLF530	80	TGL41-22A	552	W01M	478		
SBLF540	80	TGL41-24	552	W02M	478		
SBLF530CT	84	TGL41-24A	552	W04M	478		
SBLF540CT	84	TGL41-27	552	W06M	478		
SD241P	170	TGL41-27A	552	W008M	478		
SGL41-20	550	TGL41-30	552	W10M	478		
SGL41-30	550	TGL41-30A	552	ZGL41-100	548		
SGL41-40	550	TGL41-33	552	ZGL41-100A	548		
SGL41-50	550	TGL41-33A	552	ZGL41-110	548		
SGL41-60	550	TGL41-36	552	ZGL41-110A	548		
SRP100A	440	TGL41-36A	552	ZGL41-120	548		
SRP100B	440	TGL41-39	552	ZGL41-120A	548		
SRP100D	440	TGL41-39A	552	ZGL41-130	548		
SRP100G	440	TGL41-43	552	ZGL41-130A	548		
SRP100J	440	TGL41-43A	552	ZGL41-140	548		
SRP100K	440	TGL41-47	552	ZGL41-140A	548		
SRP300A	450	TGL41-47A	552	ZGL41-150	548		
SRP300B	450	TGL41-51	552	ZGL41-150A	548		
SRP300D	450	TGL41-51A	552	ZGL41-160	548		
SRP300G	450	TGL41-56	552	ZGL41-160A	548		
SRP300J	450	TGL41-56A	552	ZGL41-170	548		
SRP300K	450	TGL41-6.8	552	ZGL41-170A	548		
SRP600A	458	TGL41-6.8A	552	ZGL41-180	548		
SRP600B	458	TGL41-62	552	ZGL41-180A	548		
SRP600D	458	TGL41-62A	552	ZGL41-190	548		
SRP600J	458	TGL41-68	552	ZGL41-190A	548		
SRP600G	458	TGL41-68A	552	ZGL41-200	548		
SRP600K	458	TGL41-7.5	552	ZGL41-200A	548		
TGL41-10	552	TGL41-7.5A	552	ZGP10-100	302		
TGL41-100	552	TGL41-75	552	ZGP10-100A	302		
TGL41-100A	552	TGL41-75A	552	ZGP10-100B	302		

**GENERAL
INSTRUMENT**

QUALITY ASSURANCE

**GENERAL
INSTRUMENT**

QUALITY ASSURANCE

CUSTOMER INFORMATION

INTRODUCTION

Quality and Reliability of the Power Semiconductor Division extends its services to the areas of materials and product analysis, statistical quality control, reliability evaluation, quality inspection and development of new test methods.

Headquartered in New York, it assumes the responsibility for the development, implementation and administration of the Quality Assurance and statistical quality control programs for all operations of the Division, both domestic and foreign.

At our manufacturing plants, rigid and extensive in-process statistical quality controls are utilized such that the quality and reliability of our products are consistent and repeatable. The laboratories of our facilities are equipped with the latest high-level instrumentation and staffed with skilled technicians and engineers.

Professional expertise and the most modern scientific equipment maintains our position of excellence and leadership as the foremost producer of semiconductor devices, and assures that the quality levels of our products, from inspection and test of raw materials to final approval of completed devices, meet the highest standards of the industry.

We offer...

- ◆ *Top-flight specialists and modern facilities.*
- ◆ *Experienced Test and Reliability Engineers.*
- ◆ *Statistical Quality Control.*
- ◆ *Fully equipped laboratories able to perform all types of scientific investigation.*

SERVICES OF THE MATERIALS AND DEVICE ANALYSIS SECTION

- ◆ *Testing, inspection and evaluation of materials utilizing the facilities of the electrical, mechanical, high-reliability and chemical analysis departments of our laboratories.*
- ◆ *Research and development of testing methods.*
- ◆ *Inspection of materials to ensure compliance by suppliers and contractors to specifications.*
- ◆ *Failure analysis to determine the cause of breakdown in materials or components.*
- ◆ *Qualification testing of military devices in accordance with applicable military specifications. The laboratories are qualified to perform testing to MIL-S-19500, MIL-STD-750, MIL-STD-202, and also are qualified to MIL-STD-883 tests under MIL-M-38510. Qualification approvals (QPL listing) were awarded by the United States, Canadian and West German Departments of Defense.*
- ◆ *A continuing program of military reliability (JAN-TX) also is progress to assure conformance to the requirements for aerospace and the military.*

TEST CONDITIONS

OPERATING LIFE

Conditions: Rated voltage, rated current, for 1000 hours at 25° C.

DC BLOCKING

Conditions: Rated voltage for 1000 hours at 100° C in inert environment.

STORAGE LIFE

Conditions: 100° C for 1000 hours in inert environment.

LEAD PULL

Conditions: Axial pull to destruction.

LEAD FATIGUE

Conditions: number of 90-degree bends with 0.5 kg weight attached to lead.

MOISTURE RESISTANCE

Conditions: 85° C, 85% Relative Humidity for 10 days.

FLAMMABILITY

Conditions: Encapsulating compound, General Instrument's proprietary formulas, GI-4B or GI-5A is self-extinguishing, recognized and registered by Underwriters' Laboratories, U.S.

MOISTURE CAPABILITIES OF DIODES, RECTIFIERS, AND BRIDGES

Conditions: T = 25° C to 85° C in Operating Mode Suitability Tested by Reverse Leakage Current at Rated Voltage

SOLDERABILITY

Conditions: 95% coverage within 1.2 mm of device body.

TEMPERATURE CYCLING

Conditions: - 65° C to +175° C.

SHOCK

Conditions: 5 blows of 1500g's.

VIBRATION (CONSTANT)

Conditions 20 g's at 60 Hz ± 20 Hz.

ACCELERATION

Conditions: 20,000 g's.

SALT ATMOSPHERE

Conditions: 5% solution for 24 hours at 35° C.

Device	Yearly Average		100% RH 30 Days Continuous	95% RH 30 Days Continuous	Balance Occasional 100% RH
	≥ 95% RH	≥ 85% RH			
GPD	■		■		■
GPR	■		■		■
GP10		■	■		■
GP15		■	■		■
GP20	■		■		■
GP30	■		■		■
DO41		■		■	■
WO Series	■		■		■
KBP Series	■			■	■
KBPC Series	■		■		■
KBU Series	■			■	■

HIGH RELIABILITY - TEST CAPABILITIES

- ◆ **Barometric Pressure:** This equipment simulates low atmospheric pressure encountered in non-pressurized environments up to 200,000 feet.
- ◆ **Humidity:** This equipment evaluates units in an accelerated manner, and monitors the effects of their resistance to high humidity and heat conditions. Typical RH of 90 to 98% is achieved.
- ◆ **Salt (Spray) and Salt Atmosphere:** The equipment provides an accelerated laboratory corrosion test simulating the effects of seacoast atmospheres. Salt concentration and velocity per day can be maintained between 10,000 and 50,000 mgm/m²/day. Salt Atmosphere - Salt spray 5% - 20% salt solution.
- ◆ **Thermal Shock Temp.-Cycling:** This test determines the resistance of devices to exposure at extremely high and low temperatures. Chamber limits - 74 °C to 250 °C.
- ◆ **Mass Spectrometer Leak Detector (Fine Leak):** To determine the effectiveness (or the hermeticity) of the seal on devices with internal cavities which are evacuated on contain air or gas. Machine limits $1 - 10^{-9}$ to 10^{-6} atm.
- ◆ **Gross Leak:** Determine seal leak greater than $10 - 10^{-6}$ ATM cc/Sec.
- ◆ **Constant Acceleration:** Determines the effects of a centrifugal force on devices up to 700,000g under space environment (refrigerated vacuum).
- ◆ **Shock:** Subjects the devices to conditions resulting from sudden applied forces or abrupt changes in motion produced by rough handling, transportation or field operation from 10 to 4,500g.
- ◆ **Vibration Fatigue:** Tests the effects of vibration within the frequency range of 60 Hz at 0-70g.
- ◆ **Vibration Noise:** Measures the amount of electrical noise produced by the devices under vibration from 9-5kHz and 0-70g.
- ◆ **Non-Operating Life:** To determine the effects on devices at elevated temperatures. Temperature ranges up to 300 °C.
- ◆ **Operating Life Test:** To operate the devices under intended condition to screen and eliminate marginal devices and eliminate mortality.
 - ◆ Steady State Operating Life
 - ◆ Reverse Bias Operating Life
 - ◆ Intermittent Operating Life
- ◆ **Solderability - Lead Integrity (Lead Tension):**

Determine the solderability on all devices from 0 to 400° C. Lead Tension - Designed to check the capabilities of the devices to withstand straight pulls.
- ◆ **Lead integrity (bending stress):**

Check the quality of leads, welds and seals of the devices to withstand bends under specific weights.
- ◆ **Lead integrity (lead torque):**

Check the devices, leads and seals for resistance to twisting motion. Equipment limits from .5 cmkg to 100 mkg.
- ◆ **Hi-Power Microscopic Inspection:**

Examine internal and external construction of our devices up to 600 times.
- ◆ **Bond Strength:** This determines strength of lead bonding between the active area of the device and connecting packaging lead.

**MILITARY APPROVED
RECTIFIERS**

0.2 AMPERE TO 10 AMPERES

**GENERAL
INSTRUMENT**

GENERAL INSTRUMENT

1 IN PRICE , # 1 IN SERVICE, # 1 IN MILITARY

General Instrument Power Semiconductor Division , is the world's largest manufacturer of rectifiers and bridges, supplying over 2 billion annually. We're proud to be number one in **quality and reliability** as we are in being number one in **price and service**. And no one beats our delivery. Think bigger and better. Design-in General Instrument JAN, JANTX and JANTXV rectifiers and bridges, and see why we're The Decisive Factor in military rectifiers.

DELIVERY

As you well know, ensuring on time delivery, for those hard-to-get parts, is one of the most important and frustrating aspects of a purchasing agent's many responsibilities. We remove that stumbling block for all the JAN, JANTX, JANTXV devices we produce. As the world's largest rectifier manufacturer, you can ALWAYS count on JAN parts from stock. In addition, we have **MORE BURN-IN CAPACITY THAN ANYONE**, which guarantees shorter JANTX lead times. That's why you can count on General Instrument Power Semiconductor Division to be the Decisive Factor in your military project.

PRICING

WE ARE NOW , AND WILL ALWAYS BE, THE PRICE LEADER IN JAN, JANTX AND JANTXV MILITARY RECTIFIERS AND BRIDGES!

TECHNICAL ASSISTANCE

You'll find that buying from General Instrument Power Semiconductor Division makes a lot of sense . Consider the potential headaches we head off or eliminate with our technical assistance and support. Every one of our components is supplied with concise product data sheets that give engineers and designers complete details on electrical parameters, mechanical data, and maximum ratings as well as other vital information. Equally important is our accessibility. When questions arise with initial design, redesign, or current application, just pick up the telephone and call our applications engineering department at (516) 933-3164. We're extremely well staffed with experienced professionals to clearly and accurately answer every question.

AVAILABILITY

The following is intended as a quick guide and reference to the types of components General Instrument Power Semiconductor Division supplies:

JAN COMPONENTS

The most economical Hi-Rel device, JAN components are MIL qualified and subjected to environmental and life sample tests to assure quality conformance. JAN devices are 100 % tested, lot traceable and must pass a number of other tests (see comparison chart.) Aside from military circuits they are frequently used in commercial applications requiring superior potential life cycle performance that can not be guaranteed with standard commercial components.

JANTX AND JANTXV COMPONENTS

In addition to JAN processing, JANTX and JANTXV devices are subjected to extra environmental and electrical test as outlined in MIL-S-19500. (See comparison chart.) These screening procedures eliminate the possibility of infant mortality failures that might occur in the early stages of component system use.

PDA (percent defects allowable) requirements are applied to every lot, thereby assuring continuous quality and reliability . This effectively restricts the probability of shipping defective lots. The selection of TX and TXV components assures both **maximum component reliability and standardized reliability testing procedures**.

SPECIFICATION CONTROL DRAWINGS

Additional reliability testing, electrical screenings, or special markings are often required. General Instrument Power Semiconductor Division will guarantee that all those standards are met. We can guarantee this thanks to our state-of-the-art testing facility which provides the capability to screen devices to an equivalent "JANS" level.

HIGH RELIABILITY SCREENING SEQUENCE

GROUP A Testing - Group A testing is performed on each lot which consists of visual inspection mechanical inspections and specified electrical parametric testing

Group B Testing - Group B Testing is performed on each lot and consists of reliability testing.

Group C Testing - Group C Testing is performed on a 6 month periodic basis, and consists of long term reliability and environmental testing.

Microscopic Inspection - 100% microscopic inspection is performed on all TXV device.

Traceability - Traceability is maintained per the applicable specification and MIL-S-19500.

JAN, JANTX, JANTXV

High Temperature Storage (Non-operating) - Devices are stored in high temperatures ranging from 150°C to 200°C for stabilization.

Temperature Cycling - Devices are cycled for temperatures ranging from -65°C to +175°C to weed out structural weakness, i.e. welds, glass to metal seals and molecular lattice structure.

Shock - Specified devices are subjected to a mechanical shock test.

Acceleration - Specified devices are subjected to centrifuge.

Seal Leak (Fine) - Devices are tested with a helium mass spectrometer to locate any leaks down to 1×10^{-8} CC's per second leak rate.

Seal Leak (Gross) - Devices are checked for leaks too large for detection by tracer gases.

100% Electrical Test - Devices are subjected to all parameters of the applicable specification.

High Temperature Reverse Bias - Devices are subject to reverse bias for forty eight hours under elevated temperature.

Power - Burn in - Devices are subjected to ninety six hours of burn-in to the conditions in the applicable specifications.

100% Delta Electrical Test - Devices are subjected to all parameters of the applicable specification and delta calculations are determined. Those devices not meeting the requirements are rejected.

Resistance to Solvents - Devices are exposed to various solvents to ensure marking permanency.

Solderability - Testing is performed to determine the degree of solder coverage on the leads.

HIGH-RELIABILITY COMPARISON CHART

	JAN	JANTX	JANTXV
Microscopic Inspection (Internal Visual)	No	No	Yes
Traceability (Lot)	Yes	Yes	Yes
100% Electrical Test	Yes	Yes	Yes
High Temp Storage (Non-Operating)	Yes	Yes	Yes
Temperature Cycling	No	Yes	Yes
Acceleration (When Applicable)	No	Yes	Yes
Seal Leak (Fine)	No	Yes	Yes
Seal Leak (Gross)	No	Yes	Yes
High Temp Reverse Bias (When Applicable)	No	Yes	Yes
Electrical Test (Read & Record)	No	Yes	Yes
Power Age (Burn-in)	No	Yes	Yes
Electrical Test (Read & Record) (with Delta Limits)	No	Yes	Yes
Group A Inspection per MIL-S-19500	Yes	Yes	Yes
Group B Inspection per MIL-S-19500	Yes	Yes	Yes
Group C Inspection per MIL-S-19500	Yes	Yes	Yes
PDA (Max. Pct. Def Allow.) thru Power Burn-in	No	Yes	Yes

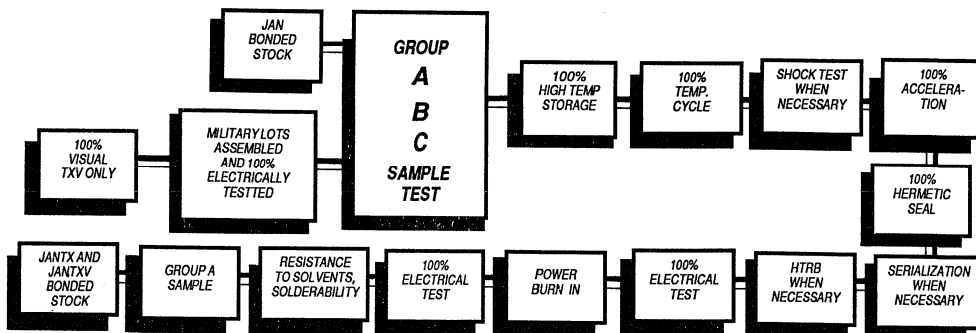

QUALIFIED PRODUCTS LIST

PRODUCT'S QUALIFIED UNDER MILITARY SPECIFICATION MIL-S-19500			
GOVERNMENT DESIGNATION	DETAIL SPEC	GOVERNMENT DESIGNATION	DETAIL SPEC
DIODES		RECTIFIERS (continued)	
JAN, JANTX, 1N483B	/118	JAN, JANTX, 1N5624	/432
JAN, JANTX, 1N485B	/118	JAN, JANTX, 1N5625	/432
JAN, JANTX, 1N486B	/118	JAN, JANTX, 1N5626	/432
		JAN, JANTX, 1N5627	/432
JAN, JANTX, 1N645	/240	JAN, JANTX, JANTXV, 1N5802	/477
JAN, JANTX, 1N647	/240	JAN, JANTX, JANTXV, 1N5804	/477
JAN, JANTX, 1N649	/240	JAN, JANTX, JANTXV, 1N5806	/477
JAN, JANTX, 1N645-1	/240	JAN, JANTX, JANTXV, 1N5907	/477
JAN, JANTX, 1N647-1	/240	JAN, JANTX, JANTXV, 1N5809	/477
JAN, JANTX, 1N649-1	/240	JAN, JANTX, JANTXV, 1N5811	/477
RECTIFIERS		BRIDGES	
JAN, JANTX, 1N3611	/228	JAN, JANTX, M19500/469-01	/469
JAN, JANTX, 1N3612	/228	JAN, JANTX, M19500/469-02	/469
JAN, JANTX, 1N3613	/228	JAN, JANTX, M19500/469-03	/469
JAN, JANTX, 1N3614	/228	JAN, JANTX, M19500/469-04	/469
JAN, JANTX, 1N3957	/228		
TRANSIENT VOLTAGE SUPPRESSORS			
JAN, JANTX, 1N4245	/286	JAN, JANTX, 1N6113,A	/516
JAN, JANTX, 1N4246	/286	JAN, JANTX, 1N6114,A	/516
JAN, JANTX, 1N4247	/286	JAN, JANTX, 1N6115,A	/516
JAN, JANTX, 1N4248	/286	JAN, JANTX, 1N6116,A	/516
JAN, JANTX, 1N4249	/286	JAN, JANTX, 1N6117,A	/516
JAN, JANTX, 1N4942	/359	JAN, JANTX, 1N6118,A	/516
JAN, JANTX, 1N4944	/359	JAN, JANTX, 1N6119,A	/516
JAN, JANTX, 1N4946	/359	JAN, JANTX, 1N6120,A	/516
JAN, JANTX, 1N4947	/359	JAN, JANTX, 1N6121,A	/516
JAN, JANTX, 1N4948	/359	JAN, JANTX, 1N6122,A	/516
JAN, JANTX, 1N5415	/411	JAN, JANTX, 1N6123,A	/516
JAN, JANTX, 1N5416	/411	JAN, JANTX, 1N6124,A	/516
JAN, JANTX, 1N5417	/411	JAN, JANTX, 1N6125,A	/516
JAN, JANTX, 1N5418	/411	JAN, JANTX, 1N6126,A	/516
JAN, JANTX, 1N5419	/411	JAN, JANTX, 1N6127,A	/516
JAN, JANTX, 1N5420	/411		
JAN, JANTX, 1N5550	/420	JAN, JANTX, 1N6128,A	/516
JAN, JANTX, 1N5551	/420	JAN, JANTX, 1N6129,A	/516
JAN, JANTX, 1N5552	/420	JAN, JANTX, 1N6130,A	/516
JAN, JANTX, 1N5553	/420		
JAN, JANTX, 1N5554	/420		
JAN, JANTX, 1N5614	/427		
JAN, JANTX, 1N5616	/427		
JAN, JANTX, 1N5618	/427		
JAN, JANTX, 1N5620	/427		
JAN, JANTX, 1N5622	/427		



JAN AND JANTX 1N483B THRU 1N486B

LOW POWER MINIATURE GLASS PASSIVATED SILICON DIODES

VOLTAGE - 70 to 225 Volts CURRENT - 200 Milliamperes

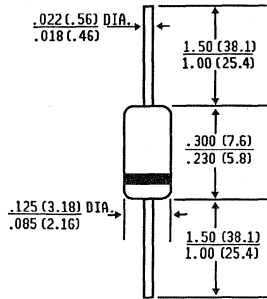

Dimensions in inches
and
(millimeters)

FEATURES

- ◆ Qualified to MIL-S-19500/118C
- ◆ High temperature metallurgically bonded
- ◆ 0.2 amperes operation at $T_A = 25^\circ\text{C}$ with no thermal runaway
- ◆ Hermetically sealed package
- ◆ Ideally suited for miniaturized equipment
- ◆ Glass passivated cavity-free junction
- ◆ High temperature soldering guaranteed $350^\circ\text{C}/10$ seconds/.375", (9.5mm) lead length at 5 lbs., (2.3kg) tension

MECHANICAL DATA

Case: One piece glass, hermetically sealed
Terminal: Plated Axial leads, solderable per MI-STD-202, Method 208
Polarity: Color band denotes cathode
Mounting Position: Any
Weight: .02 ounce, .56 gram

MAXIMUM RATINGS AND ELECTRICAL CHARACTERISTICS

Ratings at 25°C ambient temperature unless otherwise specified.
 Single phase, half wave, 60Hz, resistive or inductive load.
 For capacitive load, derate current by 20%

	SYMBOLS	JAN1N483B	JAN1N485B	JAN1N486B	UNITS
Maximum Recurrent Peak Reverse Voltage	V_{RRM}	70	180	225	Volts
Maximum RMS Voltage	V_{RMS}	50	127	159	Volts
Maximum DC Blocking Voltage	V_{DC}	70	180	225	Volts
Minimum Reverse Breakdown Voltage at $100\mu\text{A}$	V_{BR}	80	200	250	Volts
Maximum Average Forward Rectified Current .375" (9.5mm) Lead Length at $T_A = 25^\circ\text{C}$	$I_{(AV)}$	200			Milliamps
at $T_A = 150^\circ\text{C}$		50.0			
Peak Forward Surge Current, 8.3ms single half sine-wave superimposed on rated load (JEDEC Method) $T_A = 150^\circ\text{C}$	I_{FSM}	2.0			Amps
Maximum Instantaneous Forward Voltage at 100mA	V_F	1.0			Volts
Maximum DC Reverse Current $T_A = 25^\circ\text{C}$	I_R	25	25	25	nA
at Rated DC Blocking Voltage $T_A = 150^\circ\text{C}$	I_R	5.0	5.0	5.0	μA
Typical Junction Capacitance (Note 1)	C_J	15.0			pf
Typical Thermal Resistance (Note 2)	$R_{\theta JA}$	80.0			$^\circ\text{C}/\text{W}$
Operating and Storage Temperature Range	T_J, T_{STG}	-65 to +200			$^\circ\text{C}$

NOTES:

1. Measured at 1.0 MHz and applied reverse voltage of 4.0 Vdc.
2. Thermal Resistance from Junction to Ambient at .375" (9.5mm) lead lengths, P.C. Board Mounted.

MAXIMUM RATINGS AND CHARACTERISTIC CURVES JAN AND JANTX 1N483B THRU 1N486B

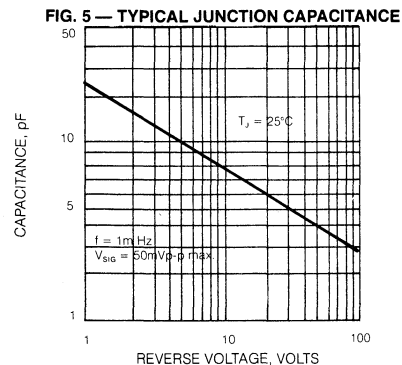
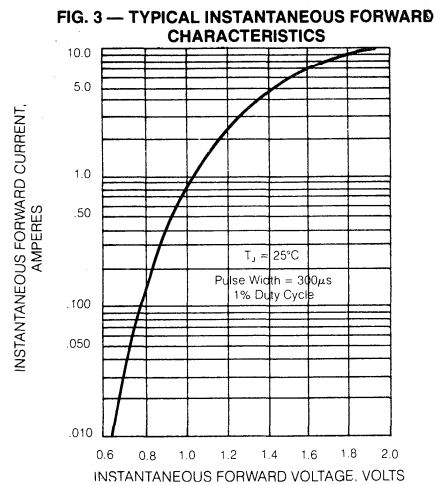
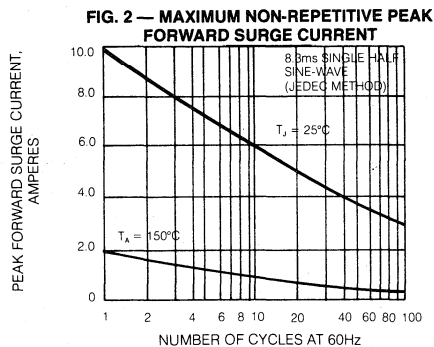
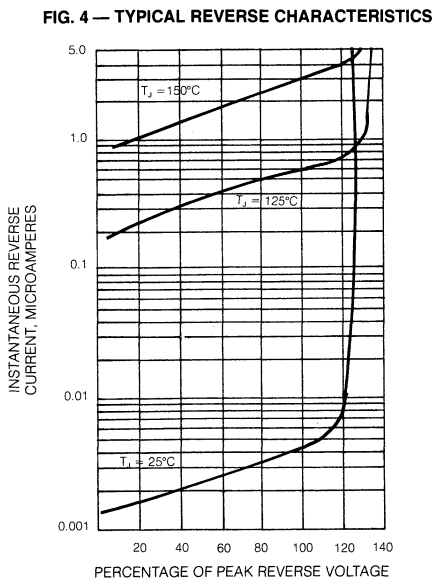
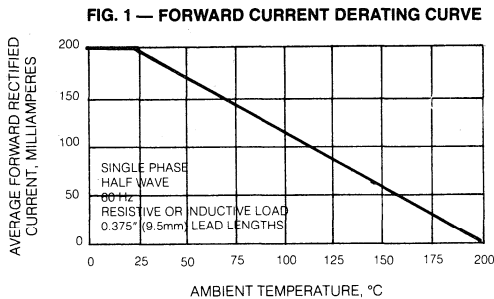



JAN AND JANTX 1N645 THRU 1N649 JAN AND JANTX 1N645-1 THRU 1N649-1

MINIATURE GLASS PASSIVATED SILICON DIODES
VOLTAGE- 225 to 600 Volts CURRENT - 400 Milliamperes

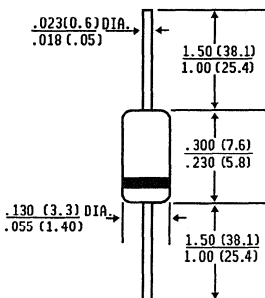

*Dimensions in inches
and
(millimeters)*

FEATURES

- ◆ Qualified to MIL-S-19500/ 240E
- ◆ Glass passivated cavity-free junction
- ◆ 0.4 amperes operation at $T_A = 25^\circ\text{C}$ with no thermal runaway
- ◆ High temperature metallurgically bonded
- ◆ Ideally suited for miniaturized equipment
- ◆ Hermetically sealed package
- ◆ High temperature soldering guaranteed: $350^\circ\text{C}/10\text{seconds}/.375"$ (9.5mm) lead length/5 lbs., (2.3kg) tension

MECHANICAL DATA

Case: One piece glass, hermetically sealed
Terminals: Plated Axial leads, solderable per MIL-STD-202, Method 208
Polarity: Color band denotes cathode
Mounting Position: Any
Weight: .02 ounce, .56 gram

MAXIMUM RATINGS AND ELECTRICAL CHARACTERISTICS

Ratings at 25°C ambient temperature unless otherwise specified. Single phase, half wave, 60Hz, resistive or inductive load. For capacitive load, derate current by 20%

	SYMBOLS	JAN	JAN	JAN	JAN	JAN	JAN	UNITS
		1N645	1N645-1	1N647	1N647-1	1N649	1N649-1	
Maximum Recurrent Peak Reverse Voltage	V_{RRM}	225	225	400	400	600	600	Volts
Maximum RMS Voltage	V_{RMS}	156	156	280	280	420	420	Volts
Maximum DC Blocking Voltage	V_{DC}	225	225	400	400	600	600	Volts
Minimum Reverse Breakdown Voltage at 100 μA 50 μA	V_{BR}	270	-	480	-	720	720	Volts
Maximum Average Forward Rectified Current, $.375"$ (9.5mm) Lead Length at $T_A = 25^\circ\text{C}$ $T_A = 150^\circ\text{C}$	$I_{(AV)}$	400						milli-Amps
Peak Forward Surge Current, 8.3.ms single half sine-wave superimposed on rated load (JEDEC Method) at $T_A = 150^\circ\text{C}$	I_{FSM}	5.0						Amps
Maximum Instantaneous Forward Voltage at 400 mA $T_A = 150^\circ\text{C}$ $T_A = 25^\circ\text{C}$ $T_A = -55^\circ\text{C}$	V_F	0.95 1.0 1.20						Volts
Maximum DC Reverse Current at Rated DC Blocking Voltage $T_A = 25^\circ\text{C}$ $T_A = 150^\circ\text{C}$	I_R	25 15	50 25	25 15	50 25	50 25	50 25	nA μA
Maximum Average Reverse Current at Peak Reverse Voltage, $I_o = 150\text{ mA}$ $T_A = 150^\circ\text{C}$ at $.375"$ 9.5mm Lead Lengths	$I_{R(AV)}$	100						μA
Maximum Junction Capacitance (Note 1)	C_J	20.0						pf
Typical Thermal Resistance (Note 2)	$R_{\theta JA}$	80.0						$^\circ\text{C}/\text{W}$
Operating Junction Temperature Range	T_J	-65 to +175						$^\circ\text{C}$
Storage Ambient Temperature Range	T_{STG}	-65 to +200						$^\circ\text{C}$

NOTES : 1. Measured at 1 MHz and applied reverse voltage of 4.0 Vdc.
 2. Thermal Resistance from Junction to Ambient at $.375"$ (9.5mm) lead lengths, P.C. Board mounted.

**MAXIMUM RATINGS AND CHARACTERISTIC CURVES
JAN AND JANTX 1N645 THRU 1N649
JAN AND JANTX 1N645-1 THRU 1N649-1**

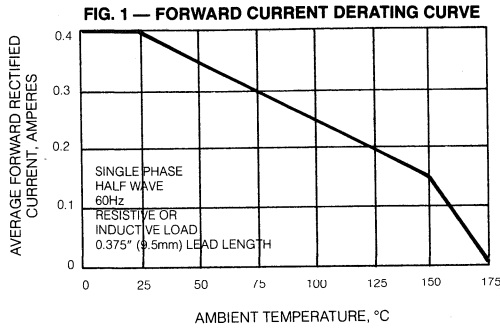

FIG. 3 — TYPICAL REVERSE CHARACTERISTICS

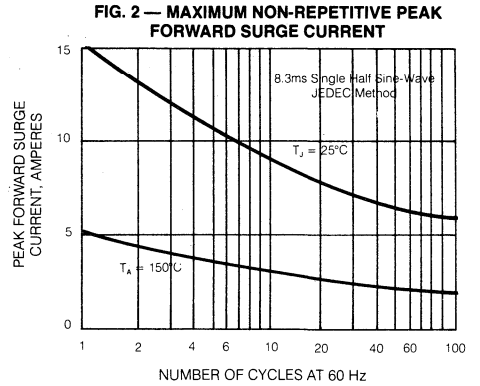
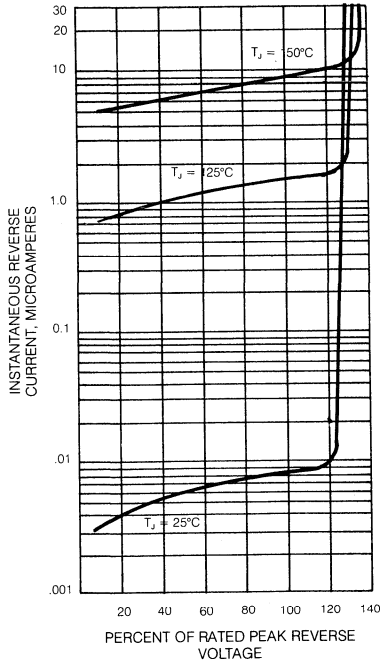

FIG. 4 — TYPICAL INSTANTANEOUS FORWARD CHARACTERISTICS

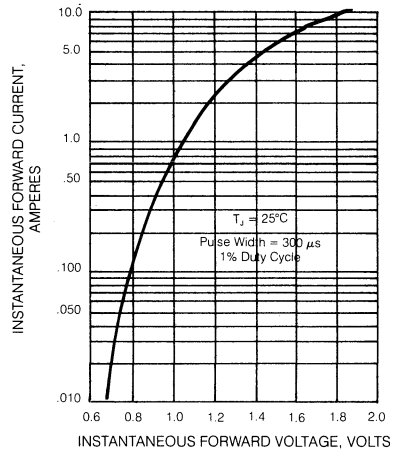
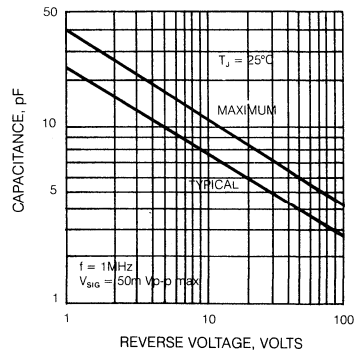

FIG. 5 — JUNCTION CAPACITANCE





JAN AND JANTX 1N3611 THRU 1N3614 AND 1N3957

MINIATURE GLASS PASSIVATED JUNCTION SILICON RECTIFIER
VOLTAGE - 200 to 1000 Volts CURRENT - 1.0 Ampere

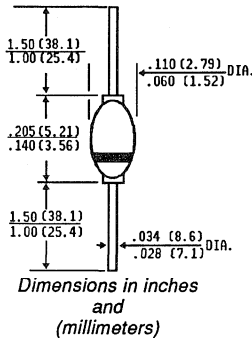

FEATURES

- ◆ Qualified to MIL-S-19500/228E
- ◆ High temperature metallurgically bonded
- ◆ Hermetically sealed package
- ◆ Glass passivated cavity-free junction
- ◆ 1.0 ampere operation at $T_A = 100^\circ\text{C}$ with no thermal runaway
- ◆ Typical I_R less than $0.1 \mu\text{A}$
- ◆ High temperature soldering guaranteed $350^\circ\text{C}/10$ seconds/.375", (9.5mm) lead length at 5 lbs., (2.3kg) tension

MECHANICAL DATA

Case: One piece glass, hermetically sealed
Terminals: Plated Axial leads, solderable per MIL-STD-202, Method 208
Polarity: Color band denotes cathode
Mounting Position: Any
Weight: 0.02 ounce, 0.56 gram

MAXIMUM RATINGS AND ELECTRICAL CHARACTERISTICS

Ratings at 25°C ambient temperature unless otherwise specified.
 Single phase, half wave, 60Hz, resistive or inductive load.
 For capacitive load, derate current by 20%

	SYMBOLS	JAN 1N3611	JAN 1N3612	JAN 1N3613	JAN 1N3614	JAN 1N3957	UNITS
Maximum Recurrent Peak Reverse Voltage	V_{RRM}	200	400	600	800	1000	Volts
Maximum RMS Voltage	V_{RMS}	140	280	420	560	700	Volts
Maximum DC Blocking Voltage	V_{DC}	200	400	600	800	1000	Volts
Minimum Reverse Breakdown Voltage at $100 \mu\text{A}$	V_{BR}	240	480	720	920	1150	Volts
Maximum Average Forward Rectified Current .375" (9.5mm) Lead Length at $T_A = 100^\circ\text{C}$	$I_{(AV)}$	1.0					Amps
Peak Forward Surge Current, 8.3ms single half sine-wave superimposed on rated load (JEDEC Method) at $T_A = 150^\circ\text{C}$	I_{FSM}	30					Amps
Maximum Instantaneous Forward Voltage at 1.0A $T_A = 25^\circ\text{C}$ $T_A = -65^\circ\text{C}$	V_F	1.1 1.5					Volts
Maximum DC Reverse Current at Rated DC Blocking Voltage $T_A = 25^\circ\text{C}$ $T_A = 150^\circ\text{C}$	I_R	1.0 300					μA
Typical Reverse Recovery Time (Note 1)	T_{RR}	2.0					μs
Typical Junction Capacitance (Note 2)	C_J	10.0					pf
Typical Thermal Resistance (Note 3)	$R_{\theta JA}$	50.0					$^\circ\text{C}/\text{W}$
Operating Junction Temperature Range	T_J	-65 to +175					$^\circ\text{C}$
Storage Ambient Temperature Range	T_{STG}	-65 to +200					$^\circ\text{C}$

NOTES:

1. Reverse Recovery Conditions: $I_F = 0.5\text{A}$, $I_R = 1.0\text{A}$, $I_{rr} = 0.25\text{A}$.
2. Measured at 1.0 MHz and applied reverse voltage of 4.0 V_{DC}.
3. Thermal Resistance from Junction to Ambient at .375" (9.5mm) lead lengths P.C. Board mounted.

**MAXIMUM RATINGS AND CHARACTERISTIC CURVES
JAN AND JANTX 1N3611 THRU 1N3614 AND 1N3957**

FIG. 1 — FORWARD CURRENT DERATING CURVE

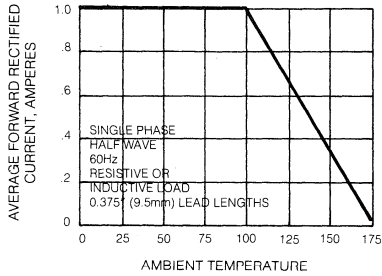

FIG. 2 — TYPICAL INSTANTANEOUS FORWARD CHARACTERISTICS

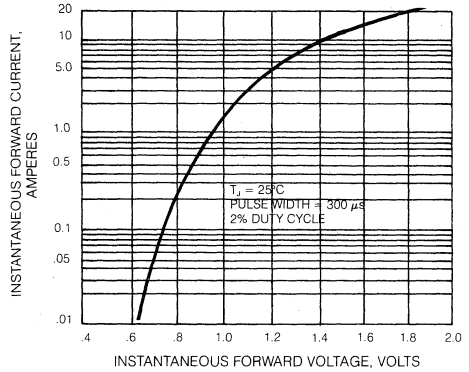

FIG. 3 — MAXIMUM NON-REPETITIVE PEAK FORWARD SURGE CURRENT

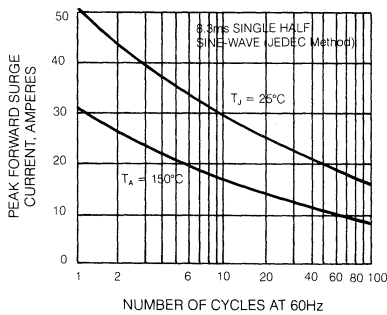

FIG. 4 — TYPICAL JUNCTION CAPACITANCE

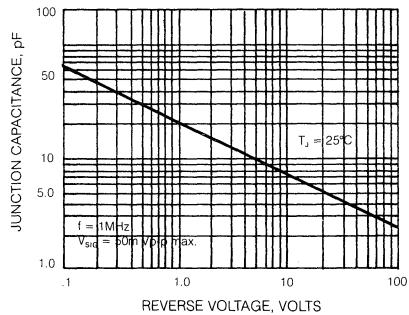
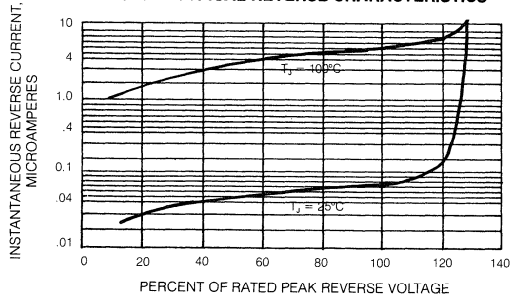

FIG. 5 — TYPICAL REVERSE CHARACTERISTICS





JAN AND JANTX 1N4245 THRU 1N4249

GLASS PASSIVATED JUNCTION MEDIUM SWITCHING RECTIFIERS

VOLTAGE - 200 to 1000 Volts CURRENT - 1.0 Ampere

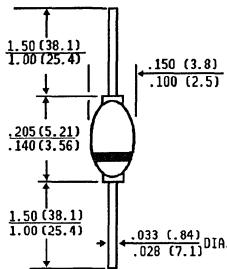

Dimensions in inches
and
(millimeters)

FEATURES

- ◆ Qualified to MIL-S-19500/286C
- ◆ High temperature metallurgically bonded
- ◆ Glass passivated cavity-free junction
- ◆ 1.0 Ampere operation at $T_A = 100^\circ\text{C}$ with no thermal runaway
- ◆ Typical I_R less than $0.1 \mu\text{A}$
- ◆ Hermetically sealed package
- ◆ High temperature soldering guaranteed: $350^\circ\text{C}/10$ seconds/.375", (9.5mm) lead length at 5 lbs., (2.3kg) tension

MECHANICAL DATA

Case: One piece glass, hermetically sealed
Terminals: Plated Axial leads, solderable per MIL-STD-202, Method 208
Polarity: Color band denotes cathode
Mounting Position: Any
Weight: .02 ounce, .56 gram

MAXIMUM RATINGS AND ELECTRICAL CHARACTERISTICS

Ratings at 25°C ambient temperature unless otherwise specified.
 Single phase, half wave, 60Hz, resistive or inductive load.
 For capacitive load, derate current by 20%.

	SYMBOLS	JAN 1N4245	JAN 1N4246	JAN 1N4247	JAN 1N4248	JAN 1N4249	UNITS
Maximum Recurrent Peak Reverse Voltage	V_{RRM}	200	400	600	800	1000	Volts
Maximum RMS Voltage	V_{RMS}	140	280	420	560	700	Volts
Maximum DC Blocking Voltage	V_{DC}	200	400	600	800	1000	Volts
Minimum Reverse Breakdown Voltage at $100\mu\text{A}$	V_{BR}	240	480	720	960	1150	Volts
Maximum Average Forward Rectified Current .375" (9.5mm) Lead Length at $T_A = 100^\circ\text{C}$	$I_{(AV)}$	1.0					Amps
Peak Forward Surge Current, 8.3ms single half sine-wave superimposed on rated load (JEDEC Method) at $T_A = 100^\circ\text{C}$	I_{FSM}	25.0					Amps
Maximum Instantaneous Forward Voltage at 3.0A	V_F	1.3					Volts
Maximum DC Reverse Current $T_A = 25^\circ\text{C}$ at Rated DC Blocking Voltage $T_A = 150^\circ\text{C}$	I_R	1.0 150					μA
Maximum Thermal Resistance (Note 3)	$R_{\theta JA}$	50.0					$^\circ\text{C}/\text{W}$
Typical Junction Capacitance (Note 1)	C_J	15					pf
Maximum Reverse Recovery Time (Note 2)	T_{RR}	5.0					μs
Operating and Storage Temperature Range	T_J, T_{STG}	-65 to +175					$^\circ\text{C}$

- NOTES:**
1. Measured at 1MHz and applied reverse voltage of 4.0 volts.
 2. Reverse Recovery Test Conditions: $I_F = 0.5\text{A}$, $I_R = 1.0\text{A}$, $I_{rr} = 0.25\text{A}$.
 3. Thermal Resistance from Junction to Ambient at .375" (9.5mm) lead lengths P.C. Board mounted.

**MAXIMUM RATINGS AND CHARACTERISTIC CURVES
JAN AND JANTX 1N4245 THRU 1N4249**

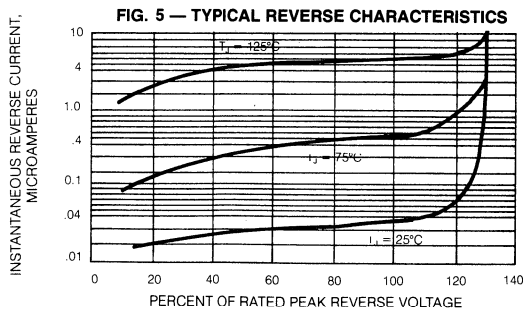
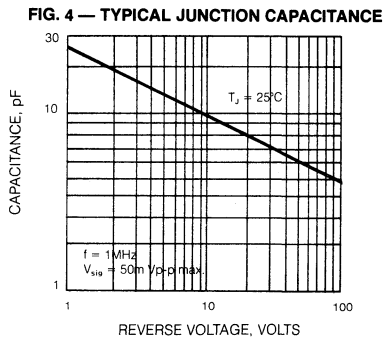
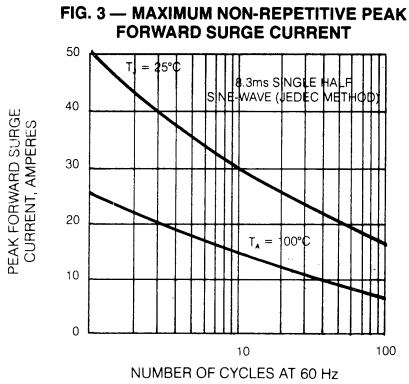
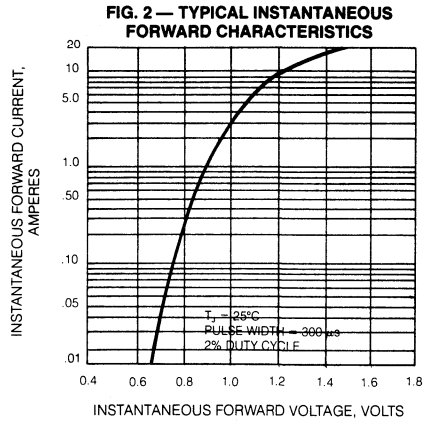
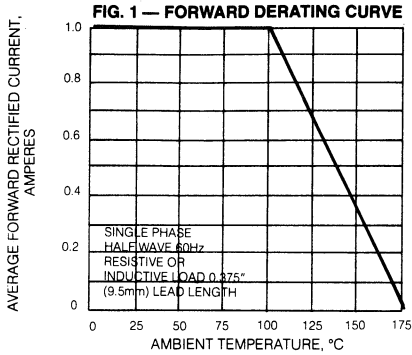



JAN AND JANTX 1N4942 THRU 1N4948

GLASS PASSIVATED JUNCTION FAST SWITCHING RECTIFIER
VOLTAGE - 200 to 1000 Volts CURRENT - 1.0 Ampere

FEATURES

MECHANICAL DATA

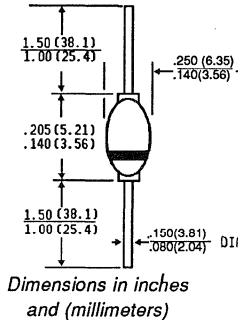

- ◆ Qualified to MIL-S-19500/359B High temperature metallurgically bonded
- ◆ Glass passivated cavity-free junction
- ◆ 1.0 Ampere operation at $T_A = 55^\circ\text{C}$ with no thermal runaway
- ◆ Hermetically sealed package
- ◆ Typical temperature soldering guaranteed: $350^\circ\text{C}/10$ seconds/.375", (9.5mm) lead length at 5 lbs., (2.3kg) tension

Case: One piece glass, hermetically sealed
Terminals: Plated Axial leads, solderable per MIL-STD-202, Method 208
Polarity: Color band denoted cathode
Mounting Position: Any
Weight: .02 ounce, .56 gram

MAXIMUM RATINGS AND ELECTRICAL CHARACTERISTICS

Ratings at 25°C ambient temperature unless otherwise specified.
 For capacitive load, derate current by 20%.

	SYMBOLS	JAN 1N4942	JAN 1N4944	JAN 1N4946	JAN 1N4947	JAN 1N4948	UNITS
Maximum Recurrent Peak Reverse Voltage	V_{RRM}	200	400	600	800	1000	Volts
Maximum RMS Voltage	V_{RMS}	140	280	420	560	700	Volts
Maximum DC Blocking Voltage	V_{DC}	200	400	600	800	1000	Volts
Minimum Reverse Breakdown Voltage at $100\mu\text{A}$	V_{BR}	220	440	660	880	1100	Volts
Maximum Average Forward Rectified Current .375" (9.5mm) Lead Length at $T_A = 55^\circ\text{C}$	$I_{(AV)}$	1.0					Amps
Peak Forward Surge Current, 8.3ms single half sine-wave superimposed on rated load (JEDEC Method) at $T_A = 100^\circ\text{C}$	I_{FSM}	15.0					Amps
Maximum Instantaneous Forward Voltage at 1.0A $T_A = 25^\circ\text{C}$ $T_A = -65^\circ\text{C}$	V_F	1.3 1.5					Volts
Maximum DC Reverse Current at Rated DC Blocking Voltage $T_A = 25^\circ\text{C}$ $T_A = 150^\circ\text{C}$	I_R	1.0 200					μA
Maximum Reverse Recovery Time (Note 1) $T_J = 25^\circ\text{C}$	T_{RR}	150		250		500	ns
Maximum Junction Capacitance (Note 2)	C_J	45	35	25	20	15	pf
Typical Thermal Resistance (Note 3)	$R_{\theta JA}$	50.0					$^\circ\text{C}/\text{W}$
Operating and Storage Temperature Range	T_J, T_{STG}	-65 to +175					C

NOTES:

1. Reverse Recovery Test Conditions : $I_F = 0.5\text{A}$, $I_R = 1.0\text{A}$, $I_{rr} = 25\text{A}$
2. Measured at 1 MHz and applied reverse voltage of 12 volts.
3. Thermal resistance from Junction to Ambient at .375"(9.5mm) lead lengths P.C.Board mounted.

MAXIMUM RATINGS AND CHARACTERISTIC CURVES JAN AND JANTX 1N4942 THRU 1N4948

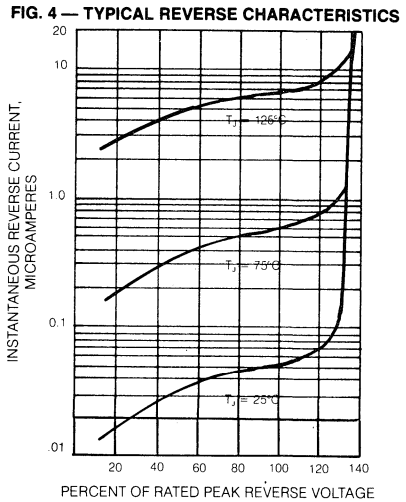
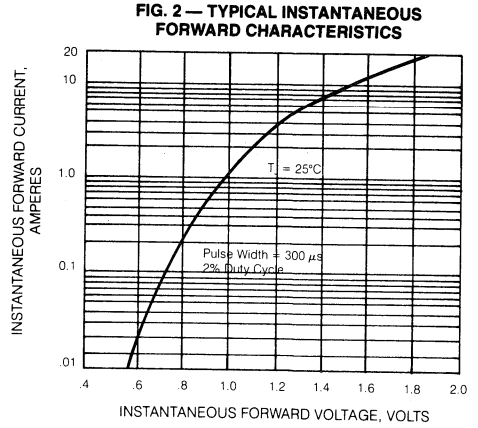
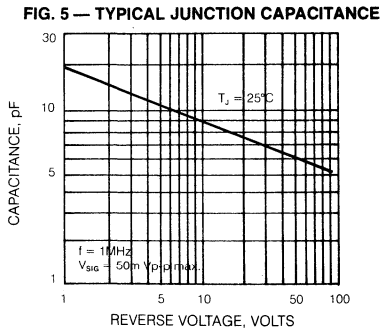
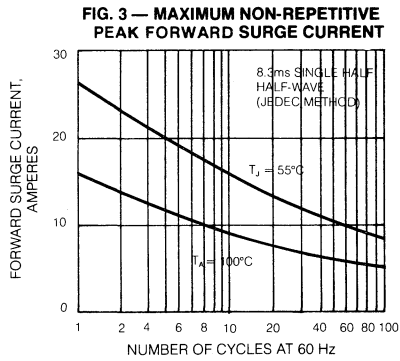
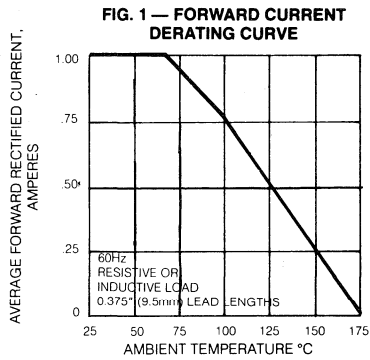
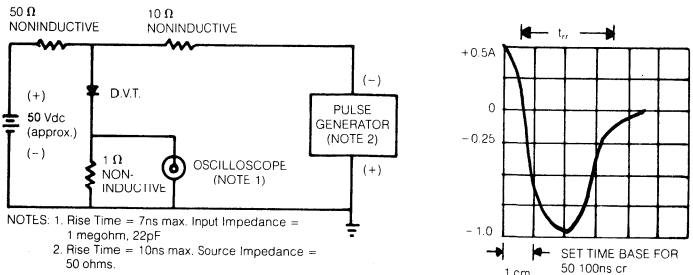

FIG. 6 — REVERSE RECOVERY TIME CHARACTERISTIC AND TEST CIRCUIT DIAGRAM





JAN AND JANTX 1N5415 THRU 1N5420

GLASS PASSIVATED JUNCTION FAST SWITCHING RECTIFIER
VOLTAGE - 50 to 600 Volts CURRENT- 3.0 Amperes

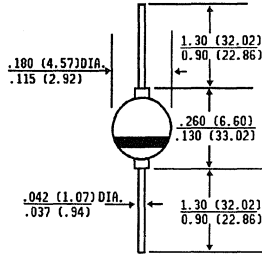

*Dimensions in inches
and
(millimeters)*

FEATURES

- ◆ Qualified to MIL-S-19500/411D
- ◆ Glass passivated cavity-free junction
- ◆ High temperature metallurgically bonded
- ◆ Fast switching for high efficiency
- ◆ 3.0 Ampere operation at $T_A = 55^\circ\text{C}$ with no thermal runaway
- ◆ Hermetically sealed package
- ◆ High temperature soldering guaranteed: $350^\circ\text{C}/10$ seconds/.375" (9.5mm) lead length/5 lbs., (2.3kg) tension

MECHANICAL DATA

Case: One piece glass, hermetically sealed
Terminals: Plated Axial leads, solderable per MIL-STD-202, Method 208
Polarity: Color band denotes cathode
Mounting Position : Any
Weight: .037 ounce, 1.04 gram

MAXIMUM RATINGS AND ELECTRICAL CHARACTERISTICS

Ratings at 25°C ambient temperature unless otherwise specified.
 Single phase, half wave, 60Hz, resistive or inductive load.
 For capacitive load, derate current by 20%.

	SYMBOLS	JAN	JAN	JAN	JAN1	JAN	JAN	UNITS
		1N5415	1N5416	1N5417	1N5418	1N5419	1N5420	
Maximum Recurrent Peak Reverse Voltage	V_{RRM}	50	100	200	400	500	600	Volts
Maximum RMS Voltage	V_{RMS}	35	70	140	280	350	420	Volts
Maximum DC Blocking Voltage	V_{DC}	50	100	200	400	500	600	Volts
Minimum Reverse Breakdown Voltage at 100 μA	V_{BR}	55	110	220	440	550	660	Volts
Maximum Average Forward Rectified Current .375" (9.5mm) Lead Length at $T_A = 55^\circ\text{C}$	$I_{(AV)}$	3.0						Amps
Peak Forward Surge Current, 8.3.ms single half sine-wave superimposed on rated load (JEDEC Method) at $T_A = 100^\circ\text{C}$	I_{FSM}	80.0						Amps
Minimum Peak Reverse Power at 20 μs pw	P_{RM}	1000						Watts
Maximum Instantaneous Forward Voltage at	V_F	1.5A $T_A = 25^\circ\text{C}$ 9.0A $T_A = 25^\circ\text{C}$ 0.5A $T_A = -55^\circ\text{C}$	1.2 1.5 1.3					Volts
Maximum DC Reverse Current at Rated DC Blocking Voltage	I_R	$T_A = 25^\circ\text{C}$ $T_A = 100^\circ\text{C}$	1.0 20.0					μA
Maximum Junction Capacitance (Note 1)	C_J	550	430	250	165	140	120	pf
Maximum Reverse Recovery Time (Note 2)	T_{RR}	150	150	150	150	250	400	ns
Maximum Thermal Resistance (Note 3)	$R_{\theta JL}$	20.0						$^\circ\text{C}/\text{W}$
Operating and Storage Temperature Range	T_J, T_{STG}	-65 to +200						$^\circ\text{C}$

NOTES :

1. Measured at 1 MHz and applied reverse voltage of 4.0 volts.
2. Reverse Recovery Test Conditions: $I_F = 1.0\text{A}$, $I_R = 1.0\text{A}$, $I_{rr} = .25\text{A}$.
3. Thermal Resistance from Junction to Lead at .375", (9.5mm) lead lengths with both leads attached to heat sink.

MAXIMUM RATINGS AND CHARACTERISTIC CURVES JAN AND JANTX 1N5415 THRU 1N5420

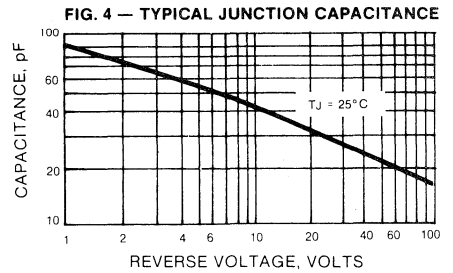
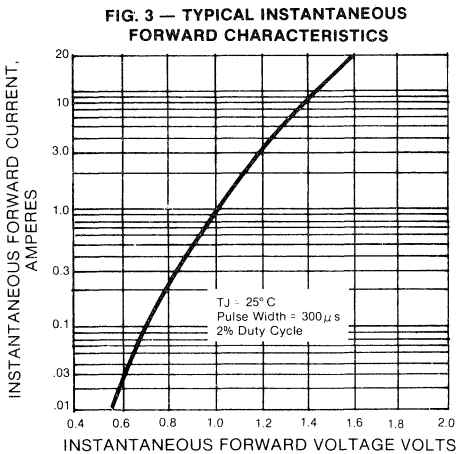
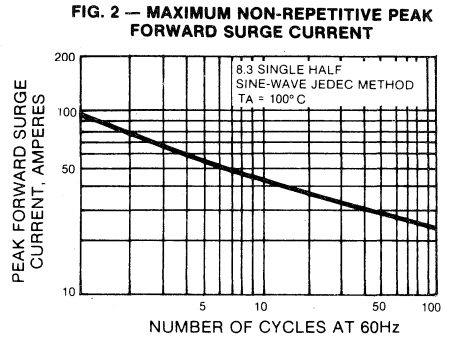
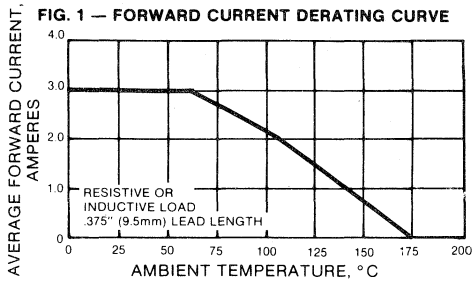
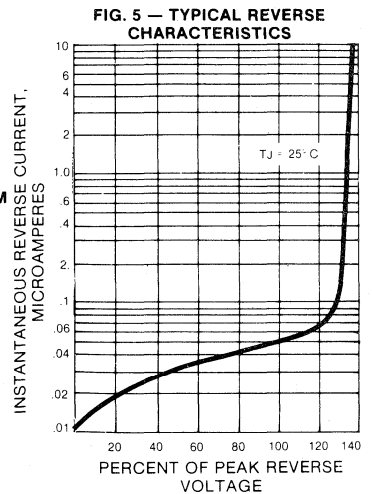
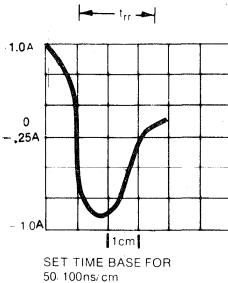
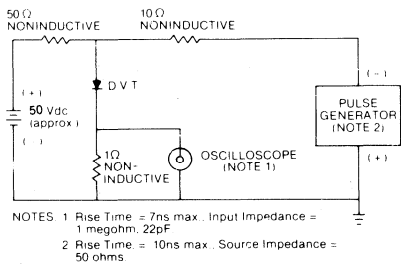

FIG. 6 — REVERSE RECOVERY TIME CHARACTERISTIC AND TEST CIRCUIT DIAGRAM





JAN AND JANTX 1N5550 THRU 1N5554

GLASS PASSIVATED JUNCTION MEDIUM SWITCHING RECTIFIER
VOLTAGE - 200 to 1000 Volts CURRENT - 3.0 Amperes

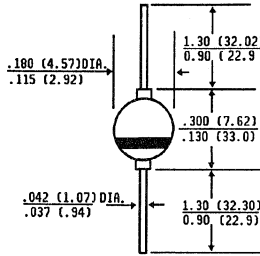

*Dimensions in inches
and
(millimeters)*

FEATURES

- ◆ Qualified to MIL-S-19500/ 420A
- ◆ Glass passivated cavity-free junction
- ◆ Medium switching for good efficiency
- ◆ High temperature metallurgically bonded
- ◆ 3.0 Ampere operation at $T_A = 55^\circ\text{C}$ with no thermal runaway
- ◆ Hermetically sealed package
- ◆ High temperature soldering guaranteed:
350°C/10seconds/.375" (.9.5mm)
lead length/5 lbs., (2.3kg) tension

MECHANICAL DATA

Case: One piece glass, hermetically sealed
Terminals: Axial leads, solderable per MIL-STD-202, Method 208
Polarity: Color band denotes cathode
Mounting Position: Any
Weight: .037 ounce, 1.04 gram

MAXIMUM RATINGS AND ELECTRICAL CHARACTERISTICS

Ratings at 25°C ambient temperature unless otherwise specified.
 Single phase, half wave, 60Hz resistive or inductive load.
 For capacitive load, derate current by 20%.

	SYMBOLS	JAN 1N5550	JAN 1N5551	JAN 1N5552	JAN 1N5553	JAN 1N5554	UNITS
Maximum Recurrent Peak Reverse Voltage	V_{RRM}	200	400	600	800	1000	Volts
Maximum RMS Voltage	V_{RMS}	140	280	420	560	700	Volts
Maximum DC Blocking Voltage	V_{DC}	200	400	600	800	1000	Volts
Minimum Reverse Breakdown Voltage at 50µA	V_{BR}	240	480	660	880	1100	Volts
Maximum Average Forward Rectified Current .375" (9.5mm) Lead Length at $T_A = 55^\circ\text{C}$ $T_L = 55^\circ\text{C}$	$I_{(AV)}$	3.0			5.0		Amps
Peak Forward Surge Current, 8.3ms single half sine-wave superimposed on rated load (JEDEC Method) at $T_A = 55^\circ\text{C}$	I_{FSM}	100					Amps
Maximum Instantaneous Forward Voltage at 9.0A $T_A = 25^\circ\text{C}$ $T_A = -55^\circ\text{C}$	V_F	1.2		1.3			Volts
Maximum Reverse Current at Rated DC Blocking Voltage $T_A = 25^\circ\text{C}$ $T_A = 100^\circ\text{C}$	I_R	1.0			75.0		µA
Maximum Reverse Recovery Time (Note 1)	T_{RR}	2.0					µS
Maximum Thermal Resistance (Note 2)	$R_{\theta J-L}$	22.0					°C/W
Operating Junction Temperature Range	T_J	-65 to +175					°C
Storage Ambient Temperature Range	T_{STG}	-65 to +200					°C

NOTES:

1. Reverse Recovery Test Conditions: $I_F = 0.5A$, $I_R = 1.0A$, $I_{rr} = .25A$.
2. Thermal Resistance from Junction to Lead at .375" (9.5mm) lead lengths with both leads attached to heat sink.

MAXIMUM RATINGS AND CHARACTERISTIC CURVES JAN AND JANTX 1N5550 THRU 1N5554

FIG. 1 — FORWARD CURRENT DERATING CURVE

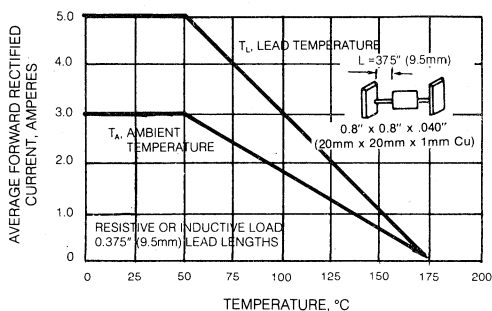

FIG. 3 — TYPICAL INSTANTANEOUS FORWARD CHARACTERISTICS

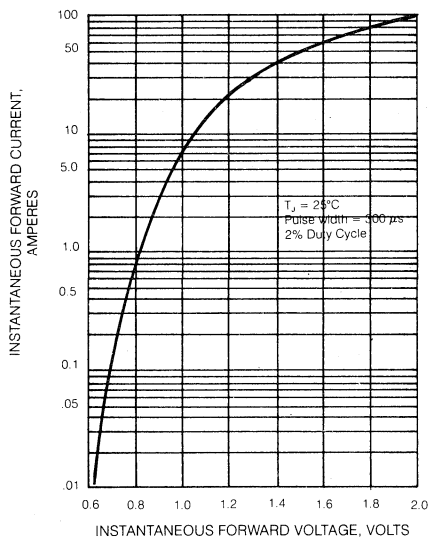

FIG. 2 — MAXIMUM NON-REPETITIVE PEAK FORWARD SURGE CURRENT

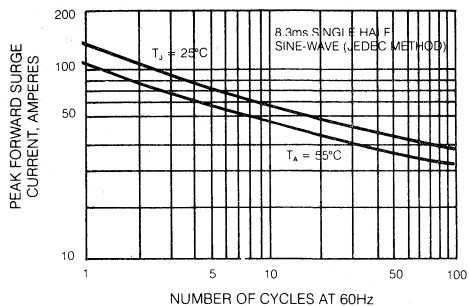

FIG. 4 — TYPICAL JUNCTION CAPACITANCE

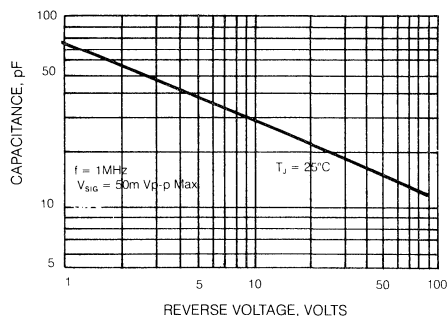
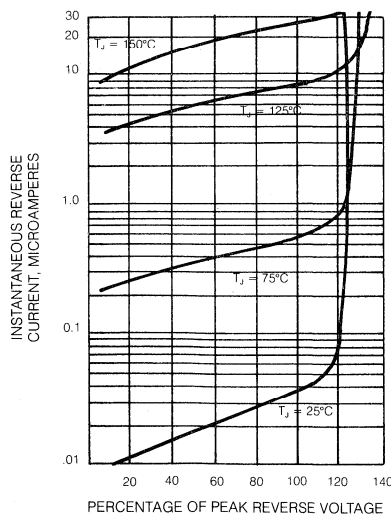

FIG. 5 — TYPICAL REVERSE CHARACTERISTICS





JAN AND JANTX 1N5615 THRU 1N5623

GLASS PASSIVATED JUNCTION FAST SWITCHING RECTIFIER
VOLTAGE - 200 to 1000 Volts CURRENT - 1.0 Ampere

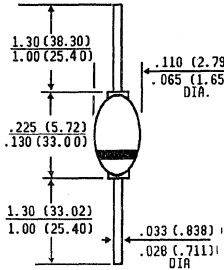

*Dimensions in inches
and
(millimeters)*

FEATURES

- ◆ Qualified to MIL-S-19500/429C
- ◆ High temperature metallurgically bonded
- ◆ Hermetically sealed package
- ◆ Glass passivated cavity-free junction
- ◆ 1.0 ampere operation at $T_A = 55^\circ\text{C}$ with no thermal runaway
- ◆ Typical I_R less than $0.1 \mu\text{A}$
- ◆ High temperature soldering guaranteed: $350^\circ\text{C}/10$ seconds/.375", (9.5mm) lead length at 5 lbs., (2.3kg) tension

MECHANICAL DATA

Case: One piece glass, hermetically sealed
Terminals: Plated Axial leads, solderable per MIL-STD-202, Method 208
Polarity: Colorband denotes cathode
Mounting Position: Any
Weight: .02 ounce, .56 gram

MAXIMUM RATINGS AND ELECTRICAL CHARACTERISTICS

Ratings at 25°C ambient temperature unless otherwise specified.
 Single phase, half wave, 60Hz, resistive or inductive load.
 For capacitive load, derate current by 20%.

	SYMBOLS	JAN	JAN	JAN	JAN	JAN	UNITS
		1N5615	1N5617	1N5619	1N5621	1N5623	
Maximum Recurrent Peak Reverse Voltage	V_{RRM}	200	400	600	800	1000	Volts
Maximum RMS Voltage	V_{RMS}	140	280	420	560	700	Volts
Maximum DC Blocking Voltage	V_{DC}	200	400	600	800	1000	Volts
Minimum Reverse Breakdown Voltage at $50\mu\text{A}$	V_{BR}	220	440	660	880	1100	Volts
Maximum Average Forward Rectified Current .375" (9.5mm) Lead Length at $T_A = 55^\circ\text{C}$	$I_{(AV)}$	1.0					Amps
Peak Forward Surge Current, 8.3ms single half sine-wave superimposed on rated load (JEDEC Method) at $T_A = 100^\circ\text{C}$	I_{FSM}	25.0					Amps
Maximum Instantaneous Forward Voltage at 3.0A	V_F	1.6					Volts
Maximum DC Reverse Current $T_A = 25^\circ\text{C}$ at Rated DC Blocking Voltage $T_A = 100^\circ\text{C}$	I_R	0.5 25.0					μA
Maximum Reverse Recovery Time (Note 1) $T_J = 25^\circ\text{C}$	T_{RR}	150	150	250	300	500	Ns
Maximum Junction Capacitance (Note 2)	C_J	45	35	25	20	15	pf
Maximum Thermal Resistance (Note 3)	$R_{\theta J L}$	38.0					$^\circ\text{C}/\text{W}$
Operating Junction Temperature Range	T_J	-65 to +175					$^\circ\text{C}$
Storage Ambient Temperature Range	T_{STG}	-65 to +200					$^\circ\text{C}$

NOTES:

1. Reverse Recovery Test Conditions: $I_F = 0.5 \text{ A}$, $I_R = 1.0 \text{ A}$, $I_{rr} = 0.25 \text{ A}$.
2. Measured at 1.0 MHz and applied reverse voltage of 12 Volts.
3. Thermal Resistance from Junction to lead at .375" (9.5mm) lead lengths P.C. Board mounted.

MAXIMUM RATINGS AND CHARACTERISTIC CURVES JAN AND JANTX 1N5615 THRU 1N5623

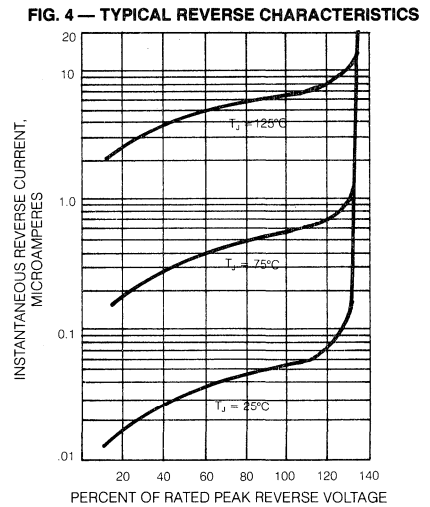
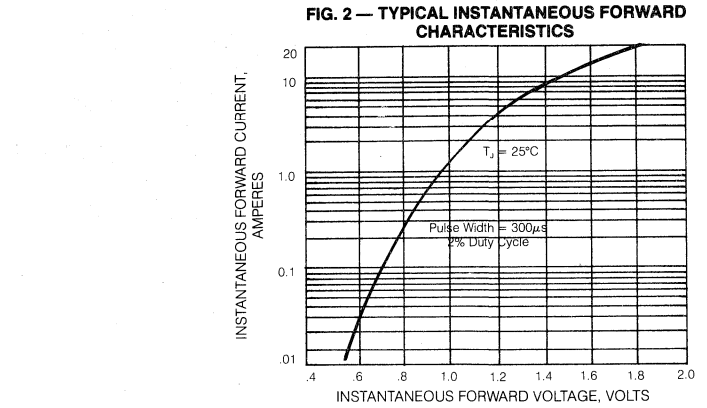
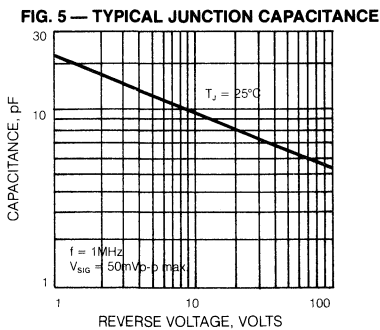
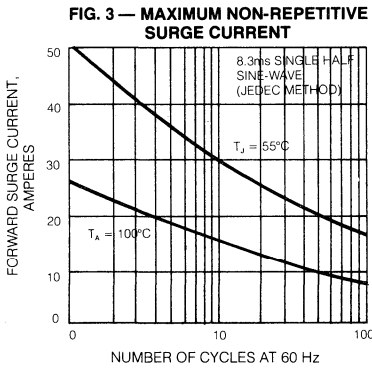
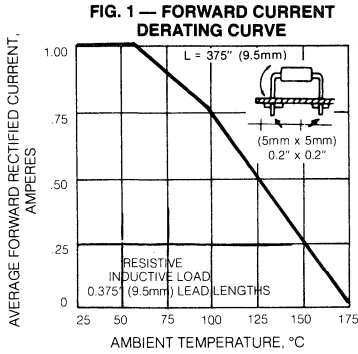
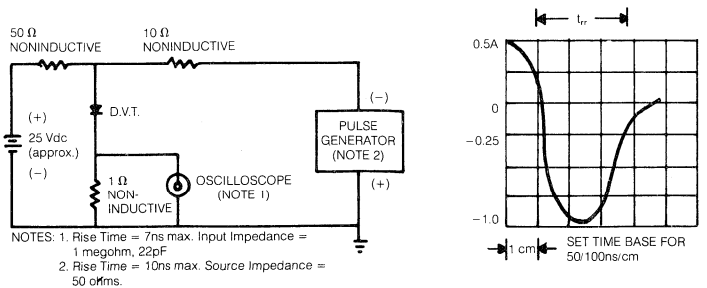

FIG. 6 — REVERSE RECOVERY TIME CHARACTERISTIC AND TEST CIRCUIT DIAGRAM



**GENERAL
INSTRUMENT**



JAN AND JANTX 1N5614 THRU 1N5622

GLASS PASSIVATED JUNCTION MEDIUM- SWITCHING RECTIFIER
VOLTAGE - 200 to 1000 Volts CURRENT - 1.0 Ampere

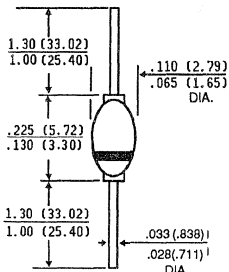

Dimensions in inches
and
(millimeters)

FEATURES

- ◆ Qualified to MIL-S-19500/427C
- ◆ High temperature metallurgically bonded
- ◆ Hermetically sealed package
- ◆ Glass passivated cavity-free junction
- ◆ 1.0 ampere operation at $T_A = 55^\circ\text{C}$ with no thermal runaway
- ◆ Typical I_R less than $0.1 \mu\text{A}$
- ◆ High temperature soldering guaranteed: $350^\circ\text{C}/10$ seconds/ $.375''$, (9.5mm) lead length at 5 lbs., (2.3kg) tension

MECHANICAL DATA

Case: One piece glass, hermetically sealed
Terminals: Plated Axial leads, solderable per MIL-STD-202, Method 208
Polarity: Color band denotes cathode
Mounting Position: Any
Weight: .02 ounce, .56 gram

MAXIMUM RATINGS AND ELECTRICAL CHARACTERISTICS

Ratings at 25°C ambient temperature unless otherwise specified.
 Single phase, half wave, 60Hz, resistive or inductive load.
 For capacitive load, derate current by 20%.

SYMBOLS	JAN 1N5614	JAN 1N5616	JAN 1N5618	JAN 1N5620	JAN 1N5622	UNITS	
Maximum Recurrent Peak Reverse Voltage	V_{RRM}	200	400	600	800	1000	Volts
Maximum RMS Voltage	V_{RMS}	140	280	420	560	700	Volts
Maximum DC Blocking Voltage	V_{DC}	200	400	600	800	1000	Volts
Minimum Reverse Breakdown Voltage at $50 \mu\text{A}$	V_{BR}	220	440	660	880	1100	Volts
Maximum Average Forward Rectified Current .375" (9.5mm) Lead Length at $T_A = 55^\circ\text{C}$	$I_{(AV)}$	1.0					Amps
Peak Forward Surge Current, 8.3ms single half sine-wave superimposed on rated load (JEDEC Method) at $T_A = 100^\circ\text{C}$	I_{FSM}	30.0					Amps
Maximum Instantaneous Forward Voltage at 3.0A	V_F	1.3					Volts
Maximum DC Reverse Current $T_A = 25^\circ\text{C}$ at Rated DC Blocking Voltage $T_A = 100^\circ\text{C}$	I_R	0.5 25.0					μA
Maximum Reverse Recovery Time (Note 1)	T_{RR}	2.0					μs
Typical Junction Capacitance (Note 2)	C_J	15					pf
Maximum Thermal Resistance (Note 3)	$R_{\theta JL}$	38.0					$^\circ\text{C}/\text{W}$
Operating Junction Temperature Range	T_J	-65 to +175					$^\circ\text{C}$
Storage Ambient Temperature Range	T_{STG}	-65 to +200					$^\circ\text{C}$

NOTES:

1. Reverse Recovery Test Conditions: $I_F = 0.5 \text{ A}$, $I_R = 1.0 \text{ A}$, $I_{rr} = 0.25 \text{ A}$.
2. Measured at 1.0 MHz and applied reverse voltage of 4.0 Vdc.
3. Thermal Resistance from Junction to lead at .375" (9.5mm) lead lengths P.C. Board mounted.

MAXIMUM RATINGS AND CHARACTERISTIC CURVES JAN AND JANTX 1N5614 THRU 1N5622

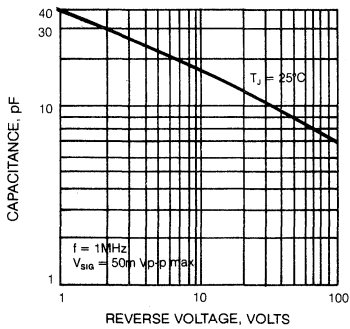
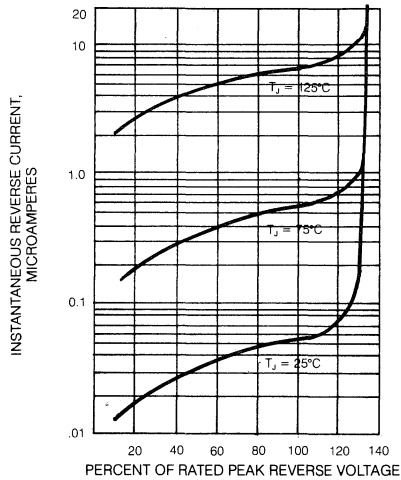
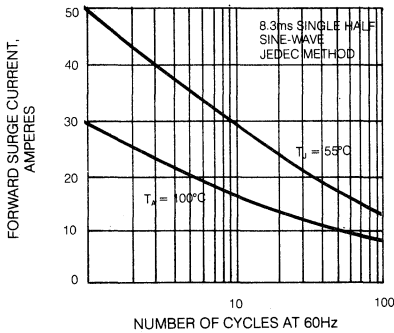
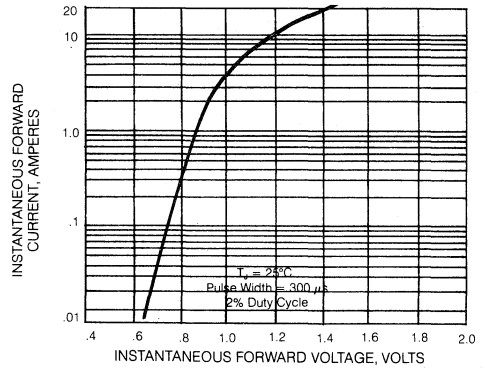
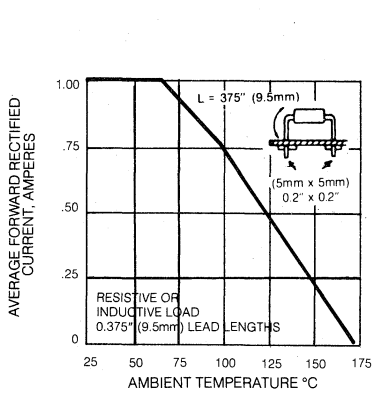
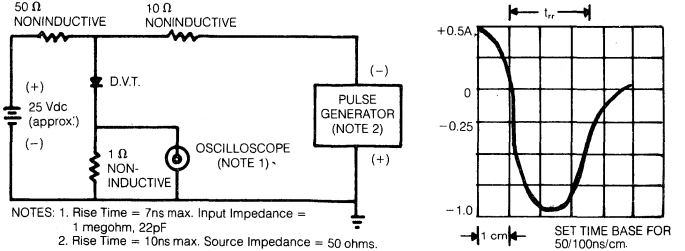

FIG. 6 — REVERSE RECOVERY TIME CHARACTERISTIC AND TEST CIRCUIT DIAGRAM





JAN AND JANTX 1N5624 THRU 1N5627

PASSIVATED JUNCTION SILICON RECTIFIER
VOLTAGE - 50 to 800 Volts CURRENT - 3.5 Amperes

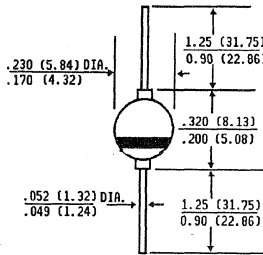

Dimensions in inches
and
(millimeters)

FEATURES

- ◆ Qualified to MIL-S-19500/432
- ◆ High temperature metallurgically bonded
- ◆ Hermetically sealed package
- ◆ Glass passivated cavity-free junction
- ◆ 3.5 ampere operation at $T_A = 55^\circ\text{C}$ with no thermal runaway
- ◆ Typical I_R less than $0.1 \mu\text{A}$
- ◆ High temperature soldering guaranteed $350^\circ\text{C}/10$ seconds/.375", (9.5mm) lead length at 5 lbs., (2.3kg) tension

MECHANICAL DATA

Case: One piece glass, hermetically sealed
Terminals: Axial leads, solderable per MIL-STD-202, Method 208
Polarity: Colorband denotes cathode
Mounting Position: Any
Weight: .037 ounce, 1.04 gram

MAXIMUM RATINGS AND ELECTRICAL CHARACTERISTICS

Ratings at 25°C ambient temperature unless otherwise specified.
 Single phase, half wave, 60Hz, resistive or inductive load.
 For capacitive load, derate current by 20%.

	SYMBOLS	JAN 1N5624	JAN 1N5625	JAN 1N5626	JAN 1N5627	UNITS
Maximum Recurrent Peak Reverse Voltage	V_{RRM}	200	400	600	800	Volts
Maximum RMS Voltage	V_{RMS}	140	280	420	560	Volts
Maximum DC Blocking Voltage	V_{DC}	200	400	600	800	Volts
Minimum Reverse Breakdown Voltage at $50 \mu\text{A}$	V_{BR}	240	460	660	880	Volts
Maximum Average Forward Rectified Current .375" (9.5mm) Lead Length at $T_A = 55^\circ\text{C}$	$I_{(AV)}$	3.5				Amps
Peak Forward Surge Current, 8.3.ms single half sine-wave superimposed on rated load (JEDEC Method) at $T_A = 100^\circ\text{C}$	I_{FSM}	125				Amps
Maximum Instantaneous Forward Voltage at 3.5A $T_A = 25^\circ\text{C}$ $T_A = -65^\circ\text{C}$	V_F	1.0 1.5				Volts
Maximum DC Reverse Current at Rated DC Blocking Voltage $T_A = 25^\circ\text{C}$ $T_A = 150^\circ\text{C}$	I_R	1.0 100				μA
Typical Junction Capacitance (Note 1)	C_J	40.0				pf
Maximum Reverse Recovery Time (Note 2) $T_J = 25^\circ\text{C}$	T_{RR}	5.0				μs
Maximum Thermal Resistance (Note 3)	$R_{\theta JL}$	18.0				$^\circ\text{C/W}$
Operating and Storage Temperature Range	T_J, T_{STG}	-65 to +200				$^\circ\text{C}$

NOTES:

1. Measured at 1.0 MHz and applied reverse voltage of 4.0 V_{DC} .
2. Reverse Recovery Test Conditions: $I_F = 0.5\text{A}$, $I_R = 1.0\text{A}$, $I_{rr} = 0.25\text{A}$.
3. Thermal Resistance from Junction to Lead at .375", 9.5mm lead lengths, with both leads attached to heat sink.

MAXIMUM RATINGS AND CHARACTERISTIC CURVES JAN AND JANTX 1N5624 THRU 1N5627

FIG. 1 — FORWARD CURRENT DERATING CURVE

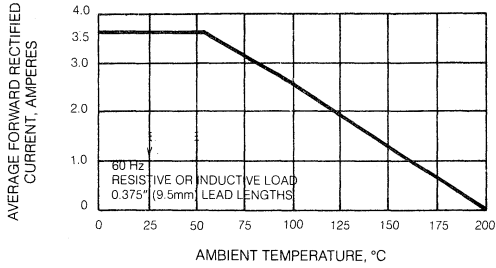

FIG. 3 — TYPICAL INSTANTANEOUS FORWARD CHARACTERISTICS

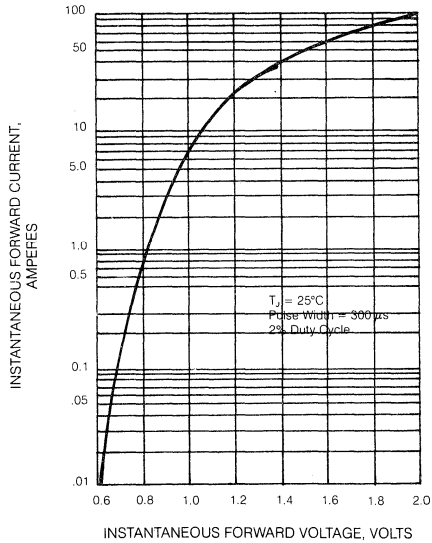

FIG. 2 — MAXIMUM NON-REPETITIVE PEAK FORWARD SURGE CURRENT

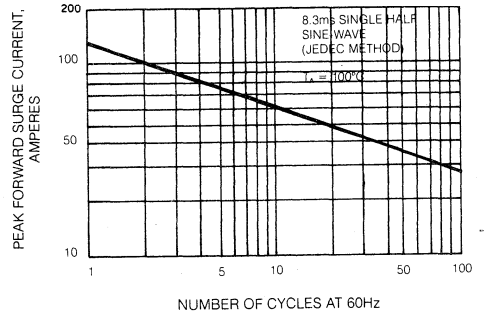

FIG. 4 — TYPICAL JUNCTION CAPACITANCE

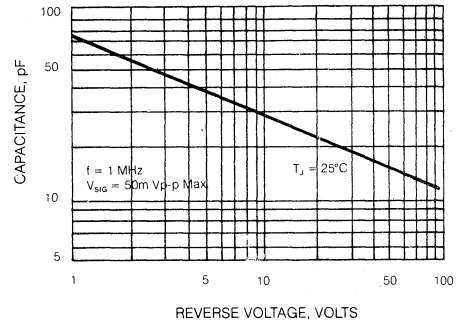
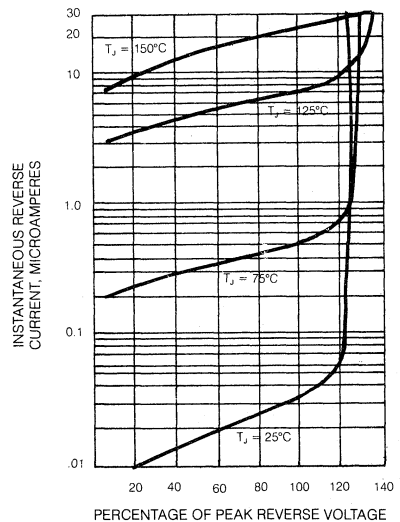

FIG. 5 — TYPICAL REVERSE CHARACTERISTICS





JAN, JANTX AND JANTXV 1N5802 THRU 1N5806

MINIATURE GLASS PASSIVATED FAST EFFICIENT SILICON RECTIFIER
VOLTAGE RANGE - 50 to 150 Volts CURRENT- 1.0 Ampere

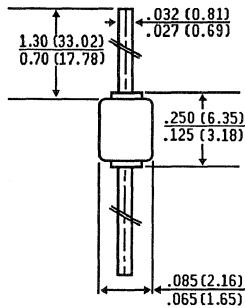

Dimensions in inches
and
(millimeters)

FEATURES

- ◆ Qualified to MIL-STD-19500/477
- ◆ Glass passivated cavity free junction
- ◆ Superfast recovery times for very high efficiency
- ◆ Low forward voltage, high current capability
- ◆ Hermetically sealed package
- ◆ High forward surge capability
- ◆ High temperature metallurgically bonded
- ◆ High temperature soldering guaranteed: 350°C, .375", (9.5mm), from case for 10 seconds at 5 lbs., (2.3kg) tension

MECHANICAL DATA

Case: One piece glass hermetically sealed
Terminals: Plated Axial leads, solderable to MIL-STD-202, Method 208
Polarity: Color band denotes cathode end
Mounting Position: Any
Weight: 0.012 ounce, 0.34

MAXIMUM RATINGS AND ELECTRICAL CHARACTERISTICS

Ratings at 25°C ambient temperature unless otherwise specified.
 Single phase, half wave, 60Hz, resistive or inductive load.
 For capacitive load, derate current by 20%

	SYMBOLS	JAN1N5802	JAN1N5804	JAN1N5806	UNITS
Maximum Recurrent Peak Reverse Voltage	V _{RRM}	50	100	150	Volts
Maximum RMS Voltage	V _{RMS}	35	70	105	Volts
Maximum DC Blocking Voltage	V _{DC}	50	100	150	Volts
Minimum Reverse Breakdown Voltage at 100µA	V _{BR}	60	110	160	Volts
Maximum Average Forward Rectified Current T _A = 55°C .375" (9.5mm) Lead Length at T _L = 75°C	I _(AV)		1.0	2.5	Amps
Peak Forward Surge Current, 8.3 ms single half sine-wave superimposed on rated load (JEDEC Method) at T _A = 55°C	I _{FSM}		35.0		Amps
Maximum Instantaneous Forward Voltage at 1.0A T _A = 25°C 2.5A T _A = 25°C 1.0A T _A = 100°C 1.0A T _A = -65°C	V _{FM}		0.875 0.975 0.800 1.075		Volts
Maximum DC Reverse Current at Rated DC Blocking Voltage T _A = 25°C T _A = 100°C	I _R		1.0 50.0		µA
Maximum Reverse Recovery Time (Note 1) T _J = 25°C	T _{RR}		25.0		ns
Maximum Forward Recovery Time at 250 mA	T _{FR}		15.0		ns
Maximum Forward Voltage Recovery at 250 mA	V _{FR}		2.2		Volts
Maximum Junction Capacitance (Note 2)	C _J		25.0		pf
Maximum Thermal Resistance (Note 3)	R _{θJL}		36.0		°C/W
Operating Junction Temperature Range	T _J		-65 to +175		°C
Storage Ambient Temperature Range	T _{STG}		-65 to +200		°C

NOTES:

1. Reverse Recovery Test Condition: I_F = 0.5A, I_R = 0.5A, I_{RR} = 0.05A, di/dt = 65 A/µs.
2. Measured at 1 MHz and applied reverse voltage of 10 volts.
3. Thermal Resistance from Junction to Lead at .375", (9.5mm) lead lengths, P.C. Board mounted.

MAXIMUM RATINGS AND CHARACTERISTIC CURVES JAN, JANTX AND JANTXV 1N5802 THRU 1N5806

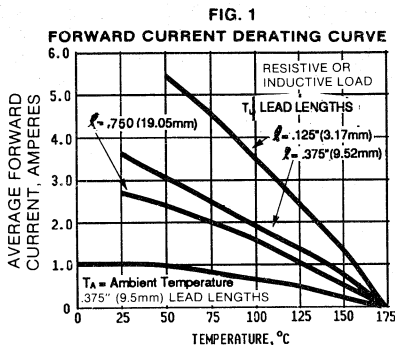

FIG. 2 — MAXIMUM NON-REPETITIVE PEAK FORWARD SURGE CURRENT

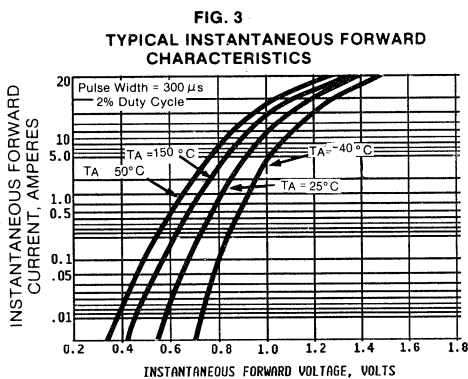
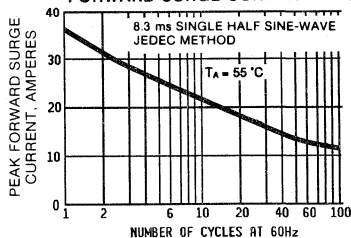

FIG. 4 — TYPICAL JUNCTION CAPACITANCE

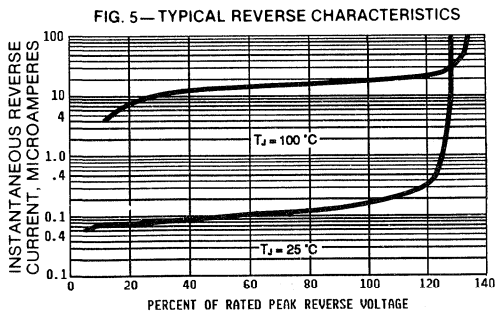
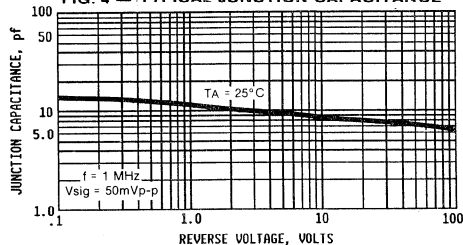
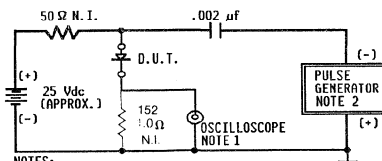
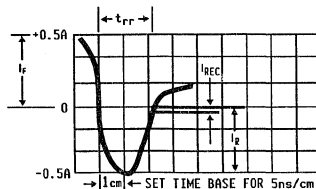

FIG. 6 — REVERSE RECOVERY TIME CHARACTERISTIC AND TEST CIRCUIT DIAGRAM



- NOTES:
1. RISE TIME = 3ns MAX. INPUT IMPEDANCE = 50 OHM MIN.
2. RISE TIME = 8ns MAX. SOURCE IMPEDANCE = 50 OHM MAX.





JAN, JANTX AND JANTXV 1N5807 THRU 1N5811

GLASS PASSIVATED FAST EFFICIENT SILICON RECTIFIERS
VOLTAGE RANGE- 50 to 150 Volts CURRENT- 6.0 Amperes

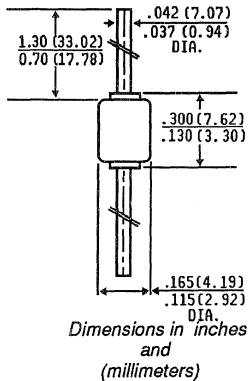

FEATURES

- ◆ Qualified to MIL-STD-19500/477
- ◆ Glass passivated cavity free junction
- ◆ Superfast recovery times for very high efficiency
- ◆ Low forward voltage, high current capability
- ◆ Hermetically sealed package
- ◆ High forward surge capability
- ◆ High temperature metallurgically bonded
- ◆ High temperature soldering guaranteed: 350°C, .375", (9.5mm), from case for 10seconds at 5 lbs., (2.3kg) tension

MECHANICAL DATA

Case: One piece glass hermetically sealed
Terminals: Axial leads, solderable to MIL-STD-202 Method 208
Polarity: Colorband denotes cathode end
Mounting Position: Any
Weight: 0.037 ounce, 1.04 grams

MAXIMUM RATINGS AND ELECTRICAL CHARACTERISTICS

Ratings at 25°C ambient temperature unless otherwise specified.
 Single phase, half wave, 60Hz resistive or inductive load.
 For capacitive load, derate current by 20%

	SYMBOL	JAN 1N5807	JAN 1N5809	JAN 1N5811	UNITS
Maximum Recurrent Peak Reverse Voltage	V _{RRM}	50	100	150	Volts
Maximum RMS Voltage	V _{RMS}	35	70	105	Volts
Maximum DC Blocking Voltage	V _{DC}	50	70	150	Volts
Minimum Reverse Breakdown Voltage at 100µA	V _{BR}	60	110	160	Volts
Maximum Average Forward Rectified Current T _A = 55°C .375" (9.5mm) Lead Length at T _L = 75°C	I _(AV)		3.0 6.0		Amps
Peak Forward Surge Current, 8.3.ms single half sine-wave superimposed on rated load (JEDEC Method) at T _A = 55°C	I _{FSM}		125		Amps
Maximum Instantaneous Forward Voltage at 4.0A T _A = 25°C 6.0A T _A = 25°C 4.0A T _A = 100°C 4.0A T _A = -65°C	V _F		0.875 0.925 0.800 1.075		Volts
Maximum DC Reverse Current at Rated DC Blocking Voltage T _A = 25°C T _A = 100°C	I _R		5.0 150		µA
Maximum Reverse Recovery Time (Note 1) T _J = 25°C	T _{RR}		30.0		ns
Maximum Forward Recovery Time at 500 mA	T _{FR}		15.0		ns
Maximum Forward Voltage Recovery at 500 mA	V _{FR}		2.2		Volts
Maximum Junction Capacitance (Note 2)	C _J		60.0		pf
Maximum Thermal Resistance (Note 3)	R _{θJL}		22.0		°C/W
Operating Junction Temperature Range	T _J		-65 to +175		°C
Storage Ambient Temperature Range	T _{STG}		-65 to +200		°C

NOTES:

1. Reverse Recovery Test Condition: I_F = 1.0A, I_R = 1.0A, I_{RR} = 0.1A, di/dt = 100 A/µs.
- 2., Measured at 1 MHz and applied reverse voltage of 10 volts.
3. Thermal Resistance from Junction to Lead at .375", (9.5mm) lead lengths with both leads attached to heat sink..

MAXIMUM RATINGS AND CHARACTERISTIC CURVES JAN, JANTX AND JANTXV 1N5807 THRU 1N5811 SERIES

FIG. 1 — FORWARD CURRENT DERATING CURVE

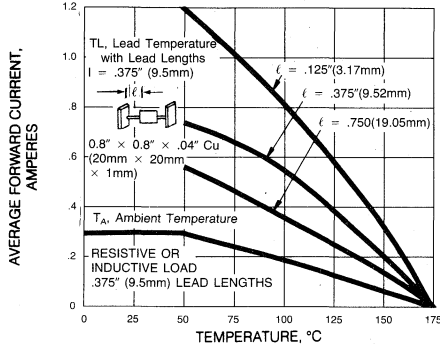

FIG. 3 — TYPICAL FORWARD CHARACTERISTICS

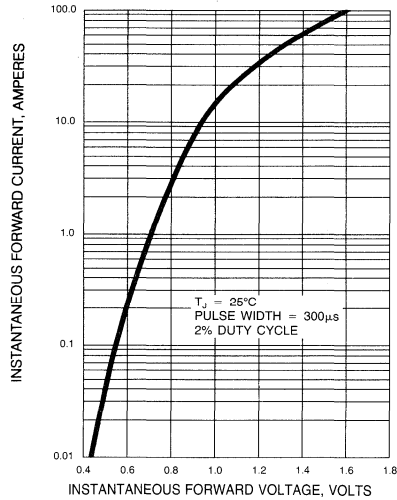

FIG. 2 — MAXIMUM NON-REPETITIVE SURGE CURRENT

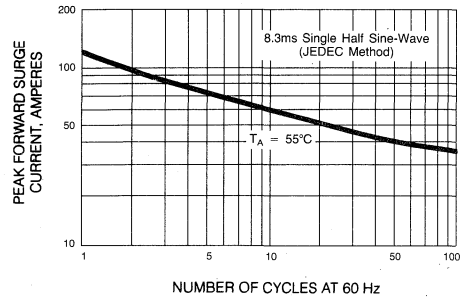

FIG. 4 — TYPICAL JUNCTION CAPACITANCE

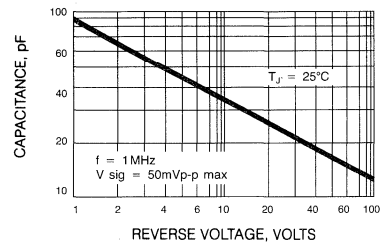

FIG. 5 — TYPICAL REVERSE CHARACTERISTICS

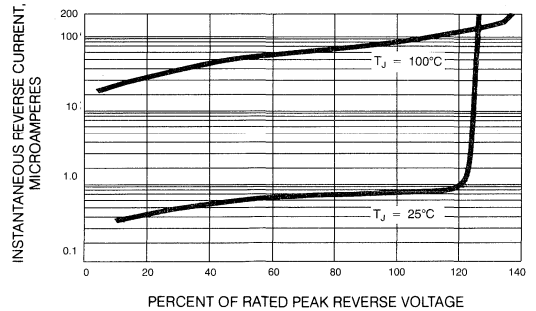
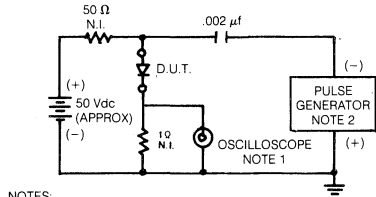
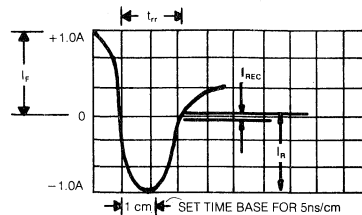

FIG. 6 — TEST CIRCUIT DIAGRAM AND REVERSE RECOVERY TIME CHARACTERISTICS



- NOTES:
1. RISE TIME = 3ns MAX. INPUT IMPEDANCE = 50 OHM MIN.
 2. RISE TIME = 8ns MAX. SOURCE IMPEDANCE = 50 OHM MAX.





JAN AND JANTX M19500 /469-01 THRU /469-04

HIGH POWER SINGLE PHASE SILICON BRIDGE RECTIFIER VOLTAGE - 200 to 800 Volts CURRENT - 10 Amperes

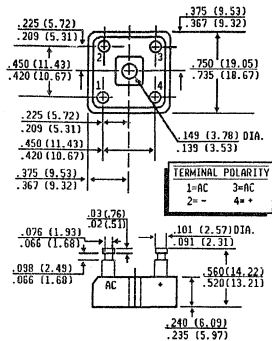

Dimensions in inches
(millimeters)

FEATURES

- ◆ Qualified to MIL-S-19500/469
- ◆ Electrically isolated metal case for maximum heat dissipation
- ◆ Hermetically sealed internal diodes
- ◆ Low forward voltage drop
- ◆ All external surfaces corrosion resistant
- ◆ Typical I_R less than $0.1 \mu A$
- ◆ High temperature soldering guaranteed $250^\circ C/10$ seconds at 5lbs., (2.3kg) tension

MECHANICAL DATA

Terminals: Tinned plated, solderable per MIL-STD-202, Method 208

Case: Metal, electrically isolated

Mounting Position: Any

Weight: 1.0 ounce, 28.3 gram

MAXIMUM RATINGS AND ELECTRICAL CHARACTERISTICS

Ratings at $25^\circ C$ ambient temperature unless otherwise specified. Single phase, half wave, 60Hz, resistive or inductive load. For capacitive load, derate current by 20%.

	SYMBOLS	JAN 469-01	JAN 469-02	JAN 469-03	JAN 469-04	UNITS
Maximum Recurrent Peak Reverse Voltage	V_{RRM}	200	400	600	800	Volts
Maximum RMS Voltage	V_{RMS}	140	280	420	560	Volts
Maximum DC Blocking Voltage	V_{DC}	200	400	600	800	Volts
Minimum Reverse Breakdown Voltage at $50 \mu A$	V_{BR}	240	460	660	880	Volts
Maximum Average Forward Rectified Current .375" (9.5mm) Lead Length at $T_C = 55^\circ C$	$I_{(AV)}$	10.0				Amps
Peak Forward Surge Current, 8.3.ms single sine-wave superimposed on rated load (JEDEC Method) at $T_C = 55^\circ C$ per leg	I_{FSM}	100				Amps
Maximum Instantaneous Forward Voltage at 15.7A per leg	V_F	$T_C = 25^\circ C$ 1.35		$T_C = -65^\circ C$ 1.50		Volts
Maximum DC Reverse Current at Rated DC Blocking Voltage	I_R	$T_C = 25^\circ C$ 2.0		$T_C = 100^\circ C$ 125		μA
Typical Junction Capacitance (Note 1)	C_J	60				pf
Maximum Reverse Recovery Time (Note 2) $T_J = 25^\circ C$	T_{RR}	2.0				μs
Dielectric With stand voltage (Note 3)		2800				Volts
Maximum Junction Temperature T_J	T_J	+175				$^\circ C$
Operating and Storage Temperature Range	T_C, T_{STG}	-65 to +150				$^\circ C$

- NOTES: 1. Measured at 1.0 MHz and applied reverse voltage of 4.0 V_{DC} .
2. Reverse Recovery Test Conditions: $I_F = 0.5A$, $I_R = 1.0A$, $I_{rr} = 0.25A$.
3. Measured between metal case to terminal with a $10 \mu A$ maximum leakage limit.

**MAXIMUM RATINGS AND CHARACTERISTIC CURVES
JAN AND JANTX M19500 /469-01 THRU /469-04**

**FIG. 1 — DERATING CURVE FOR
OUTPUT RECTIFIED CURRENT**

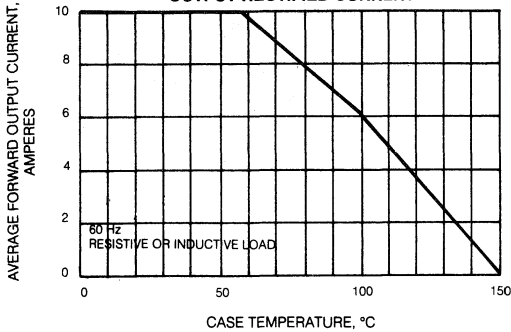

**FIG. 3 — MAXIMUM NON-REPETITIVE PEAK
FORWARD SURGE CURRENT PER BRIDGE
ELEMENT**

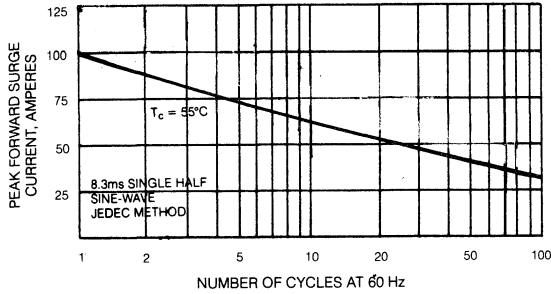

**FIG. 5 — TYPICAL JUNCTION CAPACITANCE PER
BRIDGE ELEMENT**

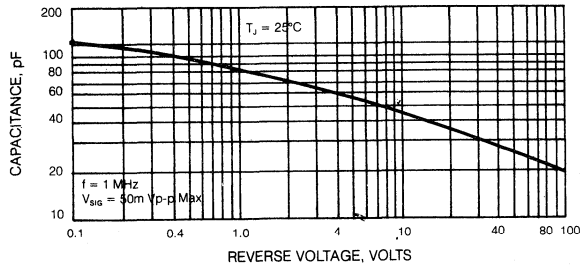

**FIG. 2 — TYPICAL INSTANTANEOUS FORWARD
CHARACTERISTICS PER
BRIDGE ELEMENT**

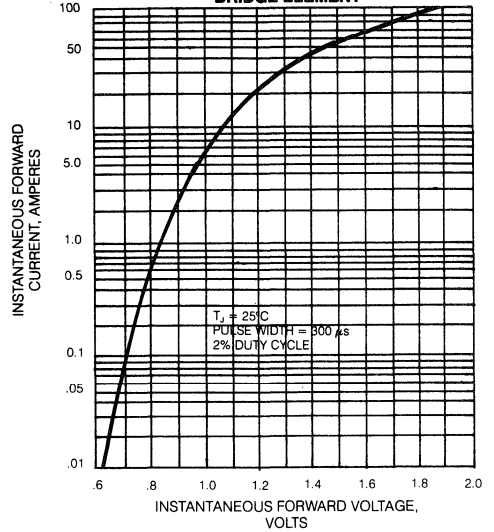

**FIG. 4 — TYPICAL REVERSE CHARACTERISTICS
PER BRIDGE ELEMENT**

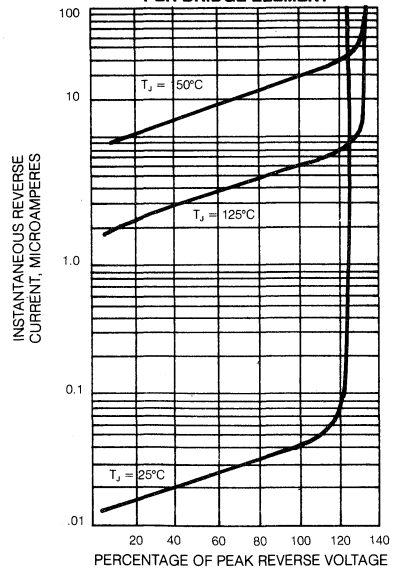



JAN AND JANTX 1N6113 THRU 1N6130

BI-DIRECTIONAL TRANSIENT VOLTAGE SUPPRESSORS
VOLTAGE - 20 to 100 POWER - 500 Watts Peak

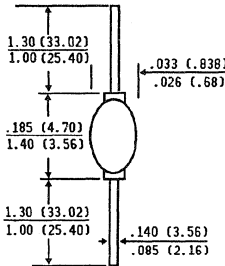

Dimensions in inches
and
(millimeters)

FEATURES

- ◆ Qualified to MIL-S-19500/516A
- ◆ High temperature metallurgically bonded-glass passivated cavity-free junction
- ◆ Voidless hermetically sealed glass package
- ◆ Low zener impedance
- ◆ Fast response time: typically less than 1.0ps from 0 volts to BV min.
- ◆ Excellent clamping capability
- ◆ High temperature soldering guaranteed 350°C/10seconds/.375" (9.5mm) lead length/5lbs., (2.3kg) tension

MECHANICAL DATA

Case: One piece glass, hermetically sealed
Terminals: Plated Axial leads, solderable per MIL-STD-202, Method 208
Polarity: No marking with bi-directional devices
Mounting Position: Any
Weight: .02 ounce, .56 gram

MAXIMUM RATINGS AND ELECTRICAL CHARACTERISTICS

Ratings at 25°C ambient temperature unless otherwise specified.
 Single phase, half wave 60 Hz, resistive or inductive load.

OPERATING AND STORAGE TEMPERATURE -65 to +175°C

Type	Breakdown Voltage @ It Min (Note 1)	Max DC Power Dissipation TL = 75°C (Note 2)	Test Current	Maximum Peak Surge Voltage @1ms	Maximum Peak Surge Current @1ms (Note 3)	Maximum Leakage current @TA=			Maximum Temperature Coefficient of V _{BR}	Maximum Peak surge at 1ms
						25°C		150°C		
						V _{BR}	V _R	I _R		
	Volts	WATTS	mA	V _{SM} V _{PK}	I _{SM} A _{PK}	I _R μA	V _R Volts	I _R μA	%/°C	P _{SM} WATTS
J and JTX, JV1N6113	18.0	3.0	65	29.0	17.2	1.0	15.2	100	.085	500
J and JTX, JV1N6114	19.8	3.0	50	31.9	15.7	1.0	16.7	100	.085	500
J and JTX, JV1N6115	21.6	3.0	50	34.8	14.4	1.0	18.2	100	.090	500
J and JTX, JV1N6116	24.3	3.0	50	39.2	12.8	1.0	20.6	100	.090	500
J and JTX, JV1N6117	27.0	3.0	40	43.6	11.5	1.0	22.8	100	.090	500
J and JTX, JV1N6118	29.7	3.0	40	47.9	10.4	1.0	25.1	100	.095	500
J and JTX, JV1N6119	32.4	3.0	30	52.3	9.6	1.0	27.4	100	.095	500
J and JTX, JV1N6120	35.1	3.0	30	56.2	8.9	1.0	29.7	100	.095	500
J and JTX, JV1N6121	38.7	3.0	30	62.0	8.1	1.0	32.7	100	.095	500
J and JTX, JV1N6122	42.3	3.0	25	67.7	7.4	1.0	35.8	100	.095	500
J and JTX, JV1N6123	45.9	3.0	25	73.5	6.8	1.0	38.8	100	.095	500
J and JTX, JV1N6124	50.4	3.0	20	80.7	6.2	1.0	42.6	100	.095	500
J and JTX, JV1N6125	55.8	3.0	20	89.3	5.6	1.0	47.1	100	100	500
J and JTX, JV1N6126	61.2	3.0	20	98.0	5.1	1.0	51.7	100	100	500
J and JTX, JV1N6127	67.5	3.0	20	108.1	4.6	1.0	56.0	100	100	500
J and JTX, JV1N6128	73.8	3.0	15	118.1	4.2	1.0	62.2	100	100	500
J and JTX, JV1N6129	81.9	3.0	15	131.1	3.8	1.0	69.2	100	100	500
J and JTX, JV1N6130	90.0	3.0	12	144.1	3.5	1.0	76.0	100	100	500

NOTES:

1. Breakdown Voltage Tolerance with no Suffix is + / -10%.
2. Lead Lengths of .375" (9.5mm).
3. Surge Current waveform per Figure 3 and Derate per figure 2.

MAXIMUM RATINGS AND CHARACTERISTIC CURVES JAN AND JANTX 1N6113 THRU 1N6130

FIGURE 1 — PULSE RATING CURVE

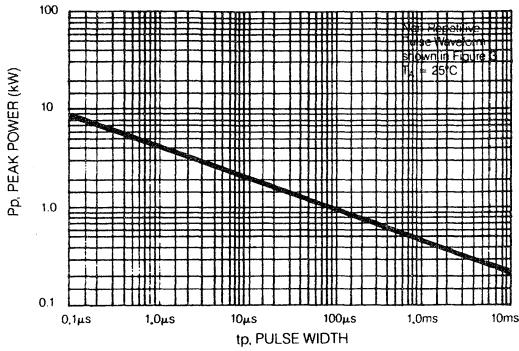

FIGURE 2 — PULSE DERATING CURVE

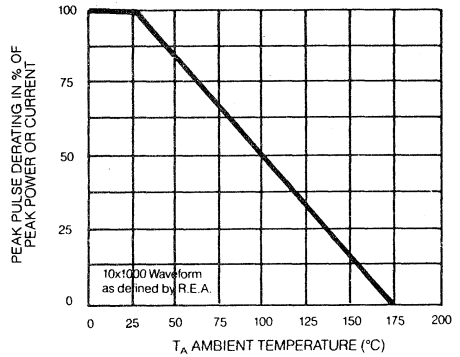

FIGURE 3 — PULSE WAVEFORM

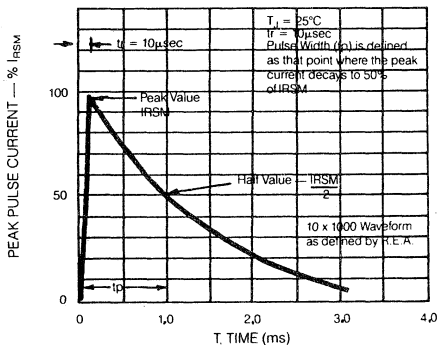

FIGURE 4 — MAXIMUM CONTINUOUS POWER DISSIPATION

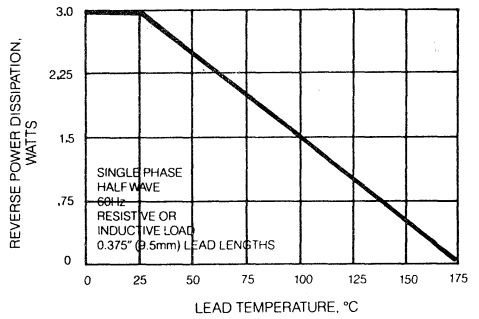
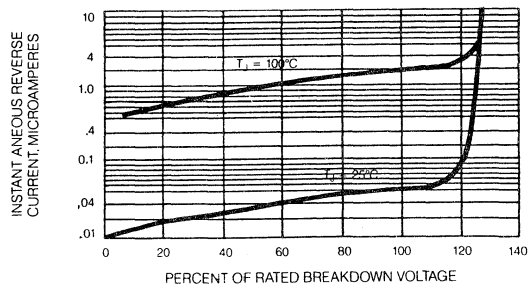

FIGURE 5 — TYPICAL REVERSE CHARACTERISTICS





JAN AND JANTX 1N6113A THRU 1N6130A

BI-DIRECTIONAL TRANSIENT VOLTAGE SUPPRESSORS VOLTAGE - 20 to 100 POWER - 500 Watts Peak

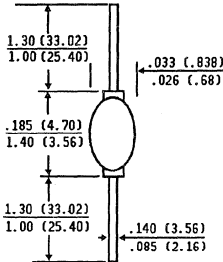

Dimensions in inches
and
(millimeters)

FEATURES

- ◆ Qualified to MIL-S-19500/516A
- ◆ High temperature metallurgically bonded-glass passivated cavity-free junction
- ◆ Voidless hermetically sealed glass package
- ◆ Low zener impedance
- ◆ Fast response time: typically less than 1.0ps from 0 volts to BV min.
- ◆ Excellent clamping capability
- ◆ High temperature soldering guaranteed 350°C/10seconds/.375" (9.5mm) lead length/5lbs., (2.3kg) tension

MECHANICAL DATA

Case: One piece glass, hermetically sealed
Terminals: Plated Axial leads, solderable per MIL-STD-202, Method 208
Polarity: No marking with bi-directional devices
Mounting Position: Any
Weight: .02 ounce, .56 gram

MAXIMUM RATINGS AND ELECTRICAL CHARACTERISTICS

Ratings at 25°C ambient temperature unless otherwise specified.
 Single phase, half wave 60 Hz, resistive or inductive load.

OPERATING AND STORAGE TEMPERATURE -65 to +175°C

Type	Breakdown Voltage @ It Min (Note 1)	Max DC Power Dissipation TL = 75°C (Note 2)	Test Current	Maximum Peak Surge Voltage @1ms	Maximum Peak Surge Current @1ms (Note 3)	Maximum Leakage current @TA=			Maximum Temperature Coefficient of VBR	Maximum Peak surge at 1ms
						25°C	150°C			
						I _r	V _r	I _r		
	V _{BR}	PD	It	V _{SM}	I _{SM}	I _r	V _r	I _r	%/C	P _{SM}
	Volts	WATTS	mA	V _{PK}	A _{PK}	μA	Volts	μA		WATTS
J and JTX, JV1N6113A	19.0	3.0	65	27.7	18.0	1.0	15.2	100	.085	500
J and JTX, JV1N6114A	20.9	3.0	50	30.5	16.4	1.0	16.7	100	.085	500
J and JTX, JV1N6115A	22.8	3.0	50	33.3	15.0	1.0	18.2	100	.090	500
J and JTX, JV1N6116A	25.7	3.0	50	37.4	13.4	1.0	20.6	100	.090	500
J and JTX, JV1N6117A	28.5	3.0	40	41.6	12.0	1.0	22.8	100	.090	500
J and JTX, JV1N6118A	31.4	3.0	40	45.7	10.9	1.0	25.1	100	.095	500
J and JTX, JV1N6119A	34.2	3.0	30	49.9	10.0	1.0	27.4	100	.095	500
J and JTX, JV1N6120A	37.1	3.0	30	53.6	9.3	1.0	29.7	100	.095	500
J and JTX, JV1N6121A	40.9	3.0	30	59.1	8.5	1.0	32.7	100	.095	500
J and JTX, JV1N6122A	44.7	3.0	25	64.6	7.7	1.0	35.8	100	.095	500
J and JTX, JV1N6123A	48.5	3.0	25	70.1	7.1	1.0	38.8	100	.095	500
J and JTX, JV1N6124A	53.2	3.0	20	77.0	6.5	1.0	42.6	100	.095	500
J and JTX, JV1N6125A	58.9	3.0	20	85.3	5.9	1.0	47.1	100	100	500
J and JTX, JV1N6126A	64.6	3.0	20	97.1	5.1	1.0	51.7	100	100	500
J and JTX, JV1N6127A	71.3	3.0	20	103.1	4.8	1.0	56.0	100	100	500
J and JTX, JV1N6128A	77.9	3.0	15	112.8	4.4	1.0	62.2	100	100	500
J and JTX, JV1N6129A	86.5	3.0	15	125.1	4.0	1.0	69.2	100	100	500
J and JTX, JV1N6130A	95.0	3.0	12	137.6	3.6	1.0	76.0	100	100	500

NOTES:

1. Breakdown Voltage Tolerance with Suffix A is + / -5%.
2. Lead Lengths of .375" (9.5mm).
3. Surge Current waveform per Figure 3 and Derate per figure 2.

**MAXIMUM RATINGS AND CHARACTERISTIC CURVES
JAN AND JANTX 1N6113A THRU 1N6130A**

FIGURE 1 — PULSE RATING CURVE

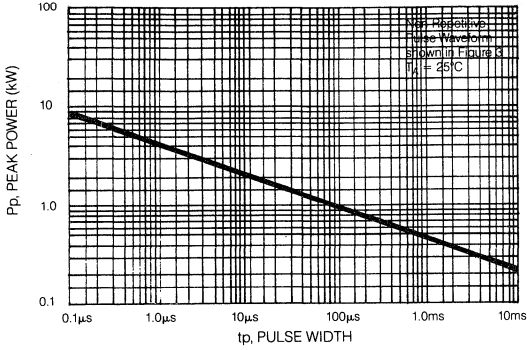

FIGURE 2 — PULSE DERATING CURVE

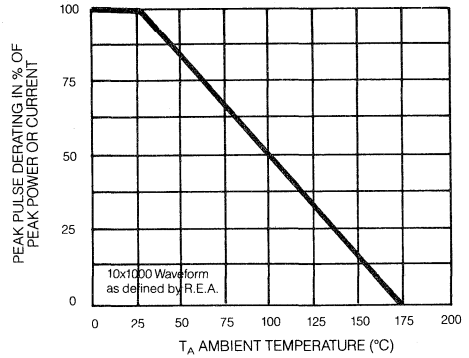

FIGURE 3 — PULSE WAVEFORM

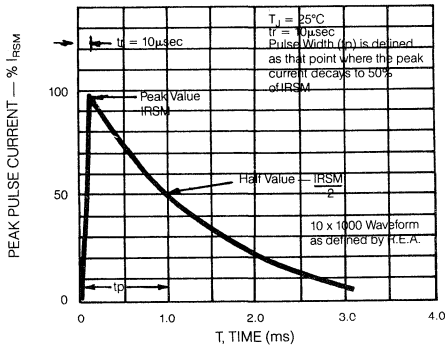

FIGURE 4 — MAXIMUM CONTINUOUS POWER DISSIPATION

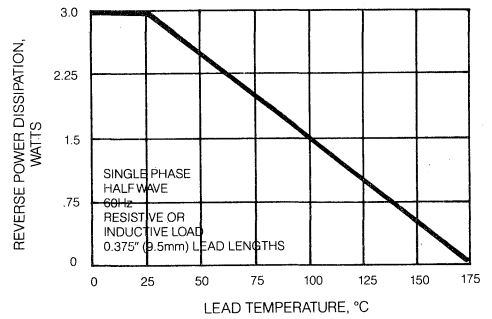
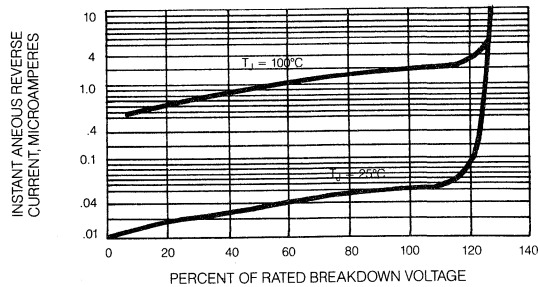

FIGURE 5 — TYPICAL REVERSE CHARACTERISTICS



SCHOTTKY RECTIFIERS

0.6 TO 40 AMPERES

**GENERAL
INSTRUMENT**

LOW CURRENT AXIAL SCHOTTKY RECTIFIERS

TYPE	SB020 thru SB040	SB120 thru SB1100	1N5817 thru 1N5819	SB320 thru SB3100	1N5820 thru 1N5822	SB520 thru SB5100
PACKAGE	MPG06	DO-41	DO-41	DO-201AD	DO-201AD	DO-201AD
IO(A)	0.6	1.0	1.0	3.0	3.0	5.0
VR=20(V)	SB020	SB120	1N5817	SB320	1N5820	SB520
VR=30(V)	SB030	SB130	1N5818	SB330	1N5821	SB530
VR=40(V)	SB040	SB140	1N5819	SB340	1N5822	SB540
VR=50(V)		SB150		SB350		SB550
VR=60(V)		SB160		SB360		SB560
VR=90(V)		SB190		SB390		SB590
VR=100(V)		SB1100		SB3100		SB5100

MEDIUM CURRENT SCHOTTKY RECTIFIERS

SINGLE RECTIFIERS

TYPE	SBLF530 thru SBLF540	SBL530 thru SBL540	MBRF735 thru MBRF760	MBR735 thru MBR760	SBLF1030 thru SBLF1040	SBL1030 thru SBL1040	MBRF1035 thru MBRF10100	MBR1035 thru MBR10100	MBRF1635 thru MBRF1660	MBR1635 thru MBR1660
PACKAGE	ITO-220	TO-220	ITO-220	TO-220	ITO-220	TO-220	ITO-220	TO-220	ITO-220	TO-220
BARRIER HEIGHT	LOW	LOW	HIGH	HIGH	LOW	LOW	HIGH	HIGH	HIGH	HIGH
IO(A)	5.0	5.0	7.5	7.5	10.0	10.0	10.0	10.0	16.0	16.0
VR=30(V)	SBLF530	SBL530			SBLF1030	SBL1030				
VR=35(V)			MBRF735	MBR735			MBRF1035	MBR1035	MBRF1635	MBR1635
VR=40(V)	SBLF540	SBL540			SBLF1040	SBL1040				
VR=45(V)			MBRF745	MBR745			MBRF1045	MBR1045	MBRF1645	MBR1645
VR=50(V)			MBRF750	MBR750			MBRF1050	MBR1050	MBRF1650	MBR1650
VR=60(V)			MBRF760	MBR760			MBRF1060	MBR1060	MBRF1660	MBR1660
VR=90(V)							MBRF1090	MBR1090		
VR=100(V)							MBRF10100	MBR10100		

MEDIUM CURRENT SCHOTTKY RECTIFIERS

DUAL RECTIFIERS

TYPE	SBLF530CT thru SBLF540CT	SBLF1030CT thru SBLF1040CT	SBL1030CT thru SBL1040CT	MBRF1535CT thru MBRF1560CT	MBR1535CT thru MBR1560CT	SBLF1630CT thru SBLF1640CT	SBL1630 thru SBL1640CT	MBRF2035CT thru MBRF20100CT	MBR2035CT thru MBR20100CT	MBRF2535CT thru MBRF2560CT	MBR2535CT thru MBR2560CT
PACKAGE	ITO-220CT	ITO-220CT	TO-220CT	ITO-220CT	TO-220CT	ITO-220CT	TO-220CT	ITO-220CT	TO-220CT	ITO-220CT	TO-220CT
BARRIER HEIGHT	LOW	LOW	LOW	HIGH	HIGH	LOW	LOW	HIGH	HIGH	HIGH	HIGH
IC(A)	5.0	10.0	10.0	15.0	15.0	16.0	16.0	20.0	20.0	30.0	30.0
VR=30(V)	SBLF530CT	SBLF1030CT	SBL1030CT			SBLF1630CT	SBL1630				
VR=35(V)				MBRF1535CT	MBR1535CT			MBRF2035CT	MBR2035CT	MBRF2535CT	MBR2535CT
VR=40(V)	SBLF540CT	SBLF1040CT	SBL1040CT			SBLF1640CT	SBL1640CT				
VR=45(V)				MBRF1545CT	MBR1545CT			MBRF2045CT	MBR2045CT	MBRF2545CT	MBR2545CT
VR=50(V)				MBRF1550CT	MBR1550CT			MBRF2050CT	MBR2050CT	MBRF2550CT	MBR2550CT
VR=60(V)				MBRF1560CT	MBR1560CT			MBRF2060CT	MBR2060CT	MBRF2560CT	MBR2560CT
VR=90(V)								MBRF2090CT	MBR2090CT		
VR=100(V)								MBRF20100CT	MBR20100CT		

MEDIUM CURRENT SCHOTTKY RECTIFIERS

DUAL RECTIFIERS CONT.

TYPE	SBLF2030PT thru SBLF2040PT	SBL2030PT thru SBL2040PT	SBLF3030PT thru SBLF3040PT	SBL3030PT thru SBL3040PT	MBRF3035PT thru MBRF3060PT	MBR3035PT thru MBR3060PT	SD241P	MBRF4035PT thru MBRF4060PT	MBR4035PT thru MBR4060PT
PACKAGE	ITO-3P	TO-3P	ITO-3P	TO-3P	ITO-3P	TO-3P	TO-3P	ITO-3P	TO-3P
BARRIER HEIGHT	LOW	LOW	LOW	LOW	HIGH	HIGH	HIGH	HIGH	HIGH
IC(A)	20.0	20.0	30.0	30.0	30.0	30.0	30.0	40.0	40.0
VR=30(V)	SBLF2030PT	SBL2030PT	SBLF3030PT	SBL3030PT					
VR=35(V)					MBRF3035PT	MBR3035PT		MBRF4035PT	MBR4035PT
VR=40(V)	SBLF2040PT	SBL2040PT	SBLF3040PT	SBL3040PT					
VR=45(V)					MBRF3045PT	MBR3045PT	SD241P	MBRF4045PT	MBR4045PT
VR=50(V)					MBRF3050PT	MBR3050PT		MBRF4050PT	MBR4050PT
VR=60(V)					MBRF3060PT	MBR3060PT		MBRF4060PT	MBR4060PT

**GENERAL
INSTRUMENT**

**AXIAL PLASTIC
SCHOTTKY RECTIFIERS**

.6 TO 5.0 AMPERES

**GENERAL
INSTRUMENT**

SB020 THRU SB040

MINIATURE SCHOTTKY BARRIER RECTIFIERS
VOLTAGE - 20 -40 Volts CURRENT - 0.6 Amperes

FEATURES

MPG06

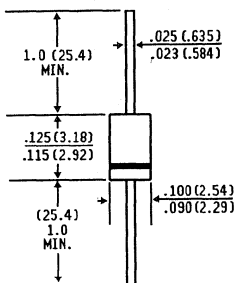

Dimensions in inches
and
millimeters

- ◆ Plastic package has Underwriters Laboratory Flammability Classification 94V-O
- ◆ Metal to silicon rectifier, majority carrier conduction
- ◆ Low power loss, high efficiency
- ◆ High current capability, low V_F
- ◆ High surge capacity
- ◆ Epitaxial construction
- ◆ Guard Ring for transient protection
- ◆ For use in low voltage, high frequency inverters, free wheeling, and polarity protection applications.
- ◆ High temperature soldering guaranteed: 250 °C/10 seconds/.375" (9.5 mm) lead lengths at 5 lbs., (2.3 kg) tension

MECHANICAL DATA

Case: Molded Plastic

Terminals: Axial leads, solderable per MIL-STD-202, Method 208

Polarity: Band denotes cathode

Mounting Position: Any

Weight: 0.0064 ounces, .181 gram

MAXIMUM RATINGS AND ELECTRICAL CHARACTERISTICS

Ratings at 25°C ambient temperature unless otherwise specified.
Resistive or inductive load.
For capacitive load, derate current by 20%.

	SYMBOLS	SB020	SB030	SB040	UNITS
Maximum Recurrent Peak Reverse Voltage	VRRM	20	30	40	Volts
Maximum RMS Voltage	VRMS	14	21	28	Volts
Maximum DC Blocking Voltage	VDC	20	30	40	Volts
Maximum Average Forward Rectified Current .375", 9.5mm Lead Length $T_A = 60^\circ\text{C}$	I(AV)	0.6			Amps
Peak Forward Surge Current, 8.3ms single half sine-wave superimposed on rated load (JEDEC Method) $T_L = 70^\circ\text{C}$	I _{FSM}	20			Amps
Maximum Forward Voltage at .6A	V _F	.55			Volts
Maximum Average Reverse Current at Peak Reverse Voltage $T_A = 25^\circ\text{C}$ $T_A = 100^\circ\text{C}$	I _R I _R	0.5 10			mA mA
Typical Thermal Resistance (Note 1)	R θ JA	65.0			°C/W
Storage and Operating Temperature Range	T _J , T _{STG}	-65 to +125			°C

NOTES:

1. Thermal Resistance Junction to Ambient Vertical PC Board Mounting, 0.5", 1.27mm Lead Length.
2. Measured at 1 MHz and applied reverse voltage of 4.0 volts.

RATINGS AND CHARACTERISTIC CURVES SB020 THRU SB040

FIG. 1 — FORWARD CURRENT DERATING CURVE

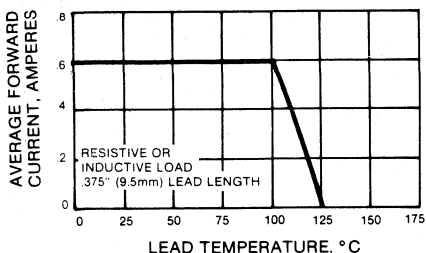

FIG. 2 — TYPICAL INSTANTANEOUS FORWARD CHARACTERISTICS

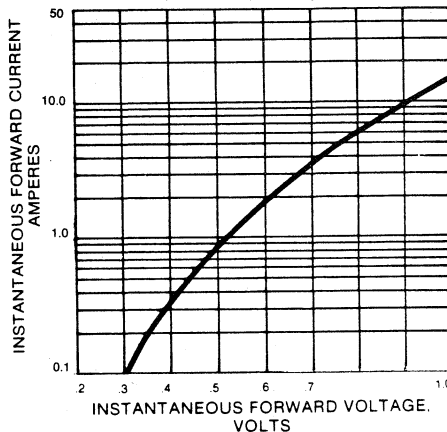

FIG. 3 — TYPICAL REVERSE CHARACTERISTICS

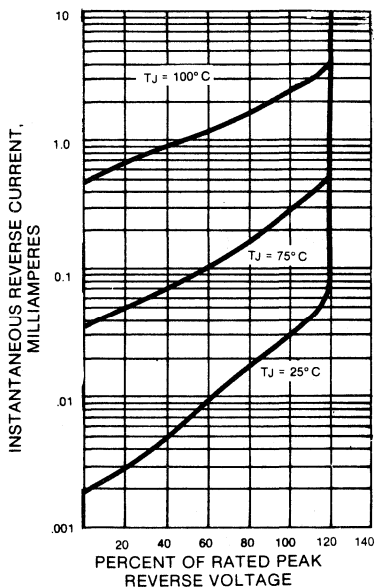

FIG. 4 — TYPICAL JUNCTION CAPACITANCE

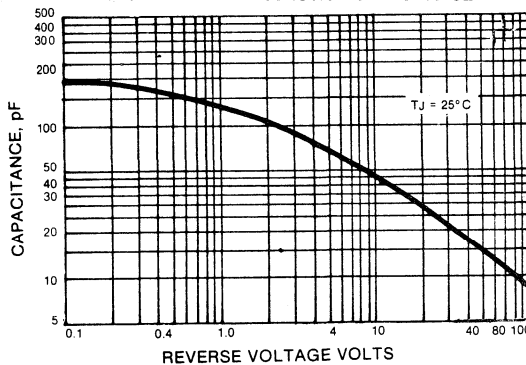
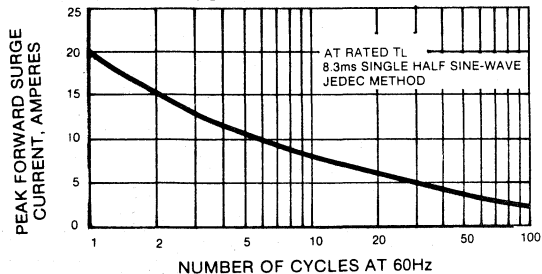

FIG. 5 — MAXIMUM NON-REPETITIVE PEAK FORWARD SURGE CURRENT



1N5817 THRU 1N5819

HIGH CURRENT SCHOTTKY BARRIER RECTIFIERS
VOLTAGE - 20 -40 Volts CURRENT - 1.0 Amperes

FEATURES

- ◆ Low cost
- ◆ Plastic package has Underwriters Laboratory Flammability Classification 94V-0
- ◆ Metal to silicon rectifier, majority carrier conduction
- ◆ Low power loss, high efficiency
- ◆ High current capability, low V_F
- ◆ High surge capacity
- ◆ Epitaxial construction
- ◆ Guard Ring for transient protection
- ◆ For use in low voltage, high frequency inverters, free wheeling, and polarity protection applications.
- ◆ High temperature soldering guaranteed: 250 °C/10 seconds/.375" (9.5 mm) lead lengths at 5 lbs., (2.3 kg) tension

DO-41

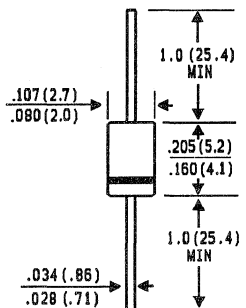

Dimensions in inches
and
millimeters

MECHANICAL DATA

Case: Molded Plastic

Terminals: Axial leads, solderable per MIL-STD-202, Method 208

Polarity: Color band denotes cathode

Mounting Position: Any

Weight: 0.012 ounces, .34 gram

MAXIMUM RATINGS AND ELECTRICAL CHARACTERISTICS

Ratings at 25°C ambient temperature unless otherwise specified.
 Resistive or inductive load.
 For capacitive load, derate current by 20%.

	SYMBOLS	1N5817	1N5818	1N5819	UNITS
*Maximum Recurrent Peak Reverse Voltage	VRRM	20	30	40	Volts
Maximum RMS Voltage	VRMS	14	21	28	Volts
Maximum DC Blocking Voltage	VDC	20	30	40	Volts
*Maximum Average Forward Rectified Current .375", 9.5mm Lead Length $T_L = 90^\circ\text{C}$	I(AV)	1.0			Amps
Peak Forward Surge Current, 8.3ms single half sine-wave superimposed on rated load (JEDEC Method) $T_L = 70^\circ\text{C}$	I _{FSM}	25			Amps
Maximum Forward Voltage at 1.0A	V_F	.45	.55	.60	Volts
Maximum Forward Voltage at 3.1A	V_F	.75	.875	90	Volts
*Maximum Average Reverse Current at Peak Reverse Voltage $T_A = 25^\circ\text{C}$	I_R	1.0			mA
$T_A = 100^\circ\text{C}$	I_R	10			mA
Typical Thermal Resistance (Note 1)	$R_{\theta JA}$	80			$^\circ\text{C/W}$
Typical Junction Capacitance (Note 2)	C_J	110			pf
*Storage and Operating Temperature Range	T_J, T_{STG}	-65 to +125			$^\circ\text{C}$

NOTES:

1. Thermal Resistance Junction to Ambient Vertical PC Board Mounting, 0.5", 1.27mm Lead Length.

2. Measured at 1 MHz and applied reverse voltage of 4.0 volts.

*JEDEC registered values

RATINGS AND CHARACTERISTIC CURVES 1N5817 THRU 1N5819

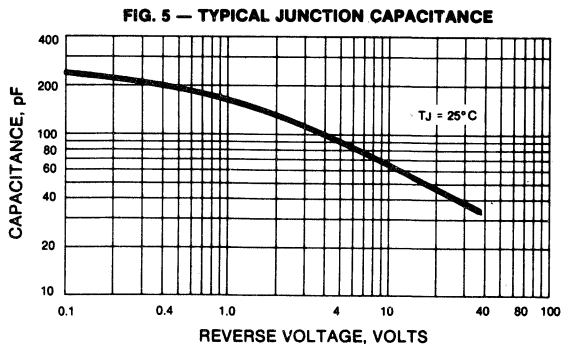
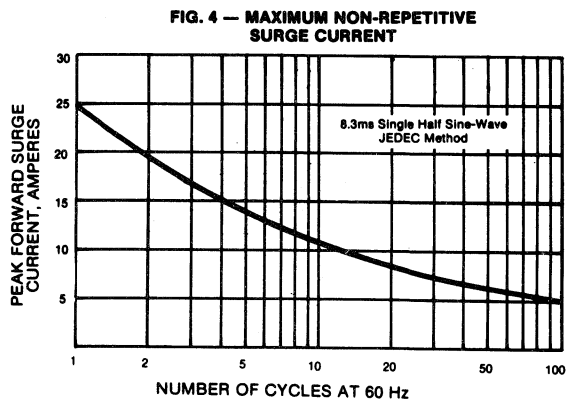
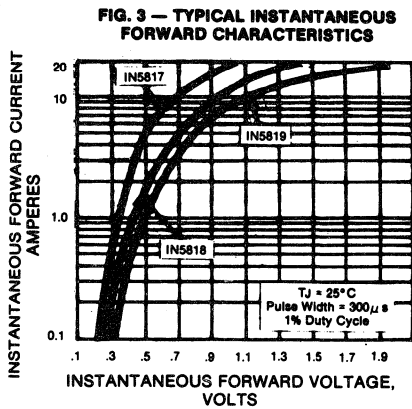
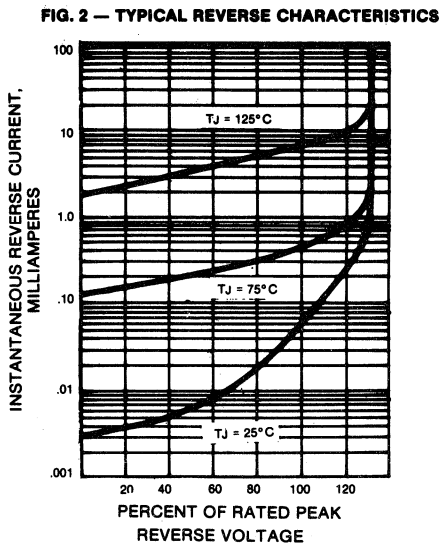
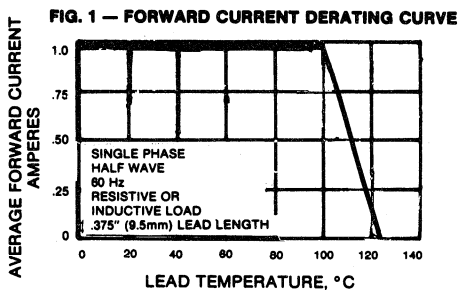

SB120 THRU SB160

MINIATURE SCHOTTKY BARRIER RECTIFIER
VOLTAGE RANGE - 20 to 60 Volts CURRENT - 1.0 Ampere

FEATURES

DO-41

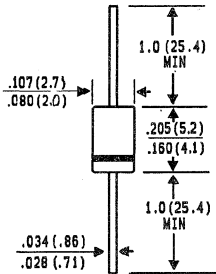

Dimensions in inches
and
millimeters

- ◆ Low cost
- ◆ Plastic material used carries Underwriters Laboratory Flammability Classifications 94V-0
- ◆ Metal to silicon rectifier, majority carrier conduction
- ◆ Low power loss, high efficiency
- ◆ High current capability, low VF
- ◆ High surge capacity
- ◆ Epitaxial construction
- ◆ Guard Ring for transient protection
- ◆ For use in low voltage, high frequency inverters, free wheeling, and polarity protection applications
- ◆ High temperature soldering guaranteed: 250°C/10 seconds/.375" (9.5mm) lead lengths/5lbs., (2.3kg) tension

MECHANICAL DATA

Case: Molded Plastic

Terminals: Axial leads, solderable per MIL-STD-202, Method 208

Polarity: Color band denotes cathode

Mounting Position: Any

Weight: 0.012 ounces, .34 gram

MAXIMUM RATINGS AND ELECTRICAL CHARACTERISTICS

Ratings at 25°C ambient temperature unless otherwise specified.
Resistive or inductive load.
For capacitive load, derate current by 20%.

	SYMBOLS	SB120	SB130	SB140	SB150	SB160	UNITS
Maximum Recurrent Peak Reverse Voltage	V _{RRM}	20	30	40	50	60	Volts
Maximum RMS Voltage	V _{RMS}	14	21	28	35	42	Volts
Maximum DC Blocking Voltage	V _{DC}	20	30	40	50	60	Volts
Maximum Average Forward Rectified Current .375", (9.5mm) Lead Length See Fig. 1	I _(AV)	1.0					Amps
Peak Forward Surge Current, 8.3ms single half sine-wave superimposed on rated load (JEDEC Method)	I _{FSM}	40.0					Amps
Maximum Instantaneous Forward Voltage at 1.0A	V _F	.50		.70			Volts
Maximum Average Reverse Current at Rated DC Blocking Voltage	I _R	0.5					mA
	I _R	10.0			5.0		mA
Maximum Thermal Resistance (Note 1)	R _{θJL}	15					°C/W
Operating Temperature Range	T _J	-65 to +125			-65 to +150		°C
Storage Temperature Range	T _{STG}	-65 to +150					°C

NOTES:

1. Thermal Resistance Junction to Lead Vertical PC Board Mounting .375" (9.5 mm) Lead Lengths.

RATINGS AND CHARACTERISTIC CURVES SB120 THRU SB160

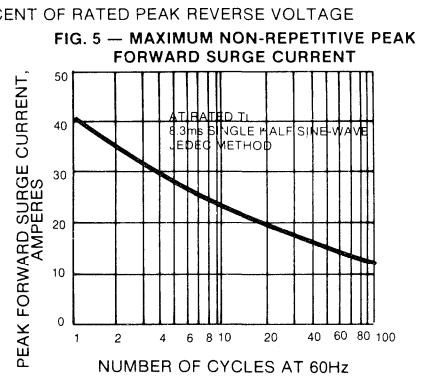
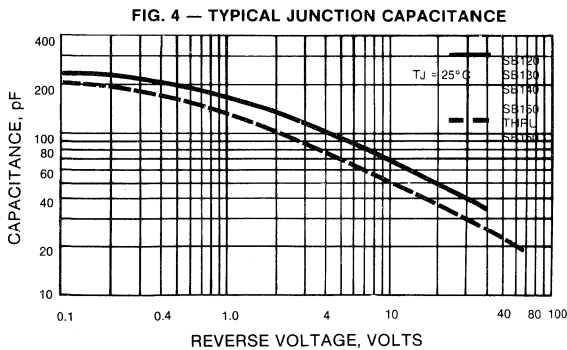
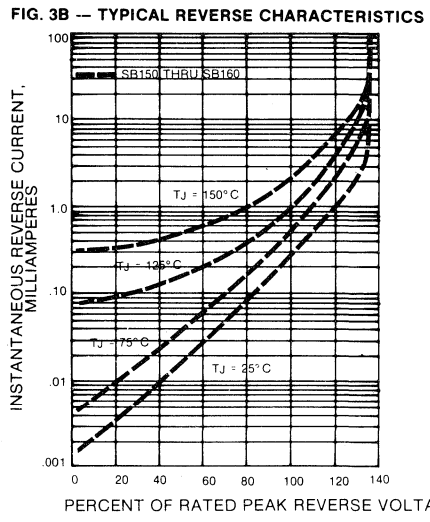
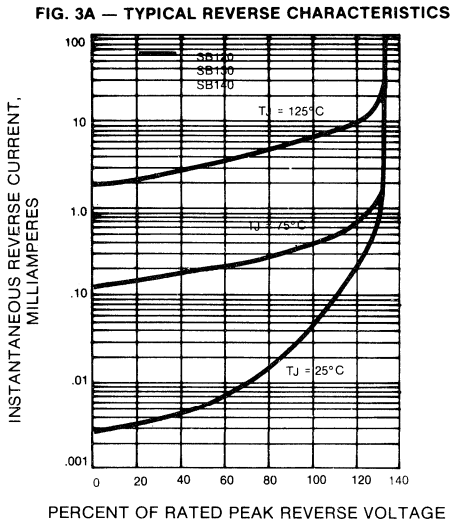
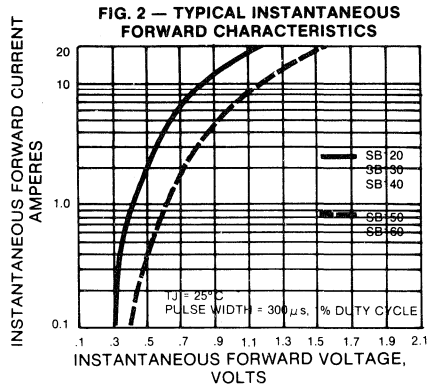
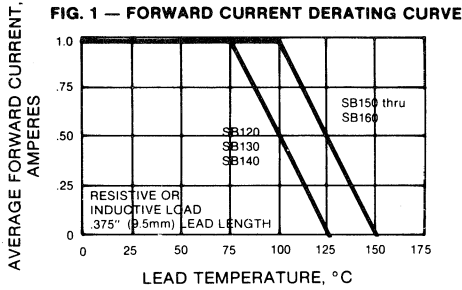

SB190 AND SB1100

MINIATURSE SCHOTTKY BARRIER RECTIFIER
VOLTAGE RANGE -90 and 100 Volts CURRENT -1.0 Amperes

FEATURES

DO-41

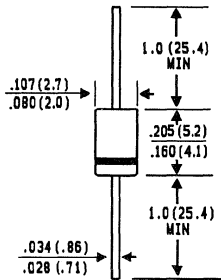

Dimensions in inches
and
(millimeters)

- ◆ Plastic package has Underwriters Laboratory Flammability Classifications 94V-O.
- ◆ Metal to silicon rectifier, majority carrier conduction
- ◆ Low power loss, high efficiency
- ◆ High current capability, low VF
- ◆ High surge capacity
- ◆ Epitaxial construction
- ◆ For use in low voltage, high frequency inverters, free wheeling, and polarity protection applications
- ◆ Guard Ring for transient protection

MECHANICAL DATA

Case: DO-41 Molded Plastic

Terminals: Axial leads, solderable per MIL-STD-202, Method 208

Polarity: Color band denotes cathode

Mounting Position: Any

Weight: 0.012 ounces, .34 gram

MAXIMUM RATINGS AND ELECTRICAL CHARACTERISTICS

Ratings at 25°C ambient temperature unless otherwise specified. Resistive or inductive load. For capacitive load, derate current by 20%.

	SYMBOLS	SB190	SB1100	UNITS
Maximum Recurrent Peak Reverse Voltage	V _{RRM}	90	100	Volts
Working Peak Reverse Voltage	V _{RWM}	64	71	Volts
DC Blocking Voltage	V _{DC}	90	100	Volts
Maximum Average Forward Rectified Current at T _C = 135°C	I _(AV)	1.0		Amps
Peak Forward Surge Current 8.3ms single half sine-wave superimposed on rated load (JEDEC Method)	I _{FSM}	50		Amps
Peak Repetitive Reverse Surge Current (2.0us, 1KHz)	I _{RSM}	1.0		Amps
Voltage Rate of Change, dv/dt (rated V _R)	V/μs	10		V/μs
Maximum Forward Voltage (Note 1) I _F = 1A, T _L = 25°C I _F = 1A, T _L = 100°C	V _F	0.79 0.69		Volts
Maximum Reverse Current at Peak Reverse Voltage T _C = 100°C (Note 1) Peak Reverse Voltage T _L = 25°C	I _R I _R	5 .5		mA mA
Maximum Thermal Resistance, Junction to Lead	R _{θJL}	15		°C/W
Maximum Operating Junction Temperature	T _C	-65 to +150		°C
Maximum Storage Temperature	T _{STG}	-65 to +175		°C

NOTES: 1. Pulse Test Pulse Width 300 μs, Duty Cycle 2%. 2. 2.0us, 1.0KHz.

RATINGS AND CHARACTERISTIC CURVES SB190 AND SB1100

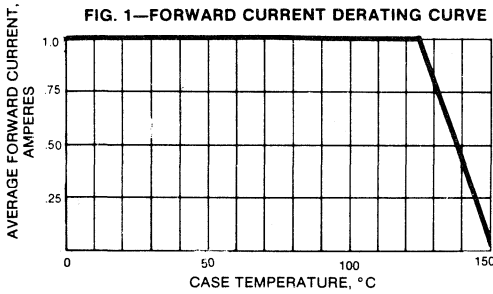

FIG. 2 — MAXIMUM NON-REPETITIVE SURGE CURRENT

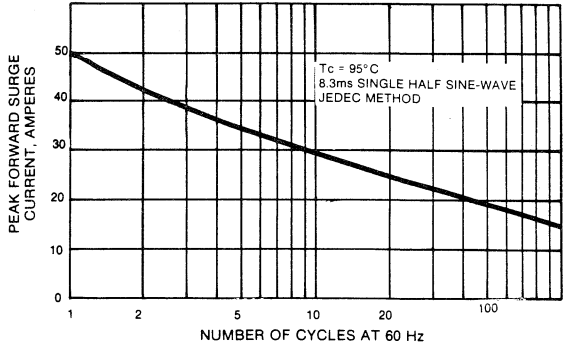

FIG. 4 — TYPICAL INSTANTANEOUS FORWARD CHARACTERISTICS

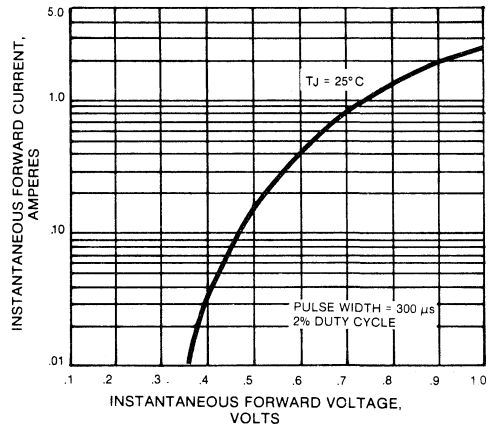

FIG. 3 — TYPICAL REVERSE CHARACTERISTICS

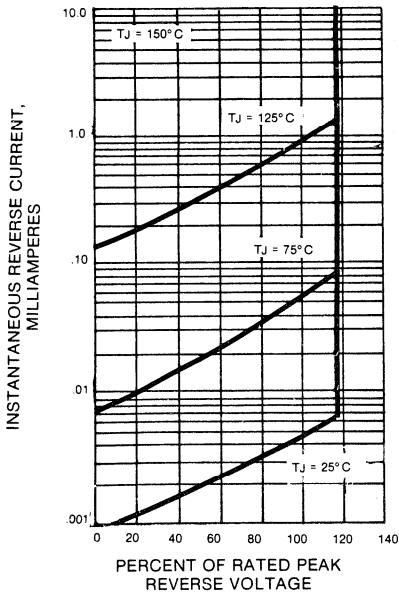
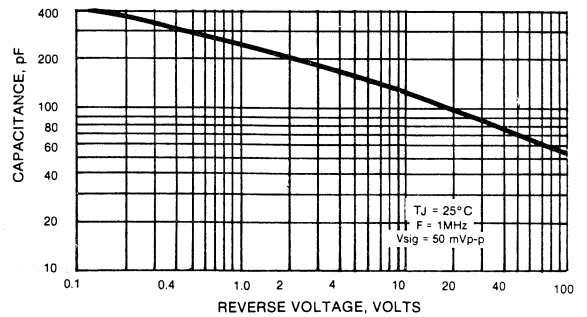

FIG. 5 — TYPICAL JUNCTION CAPACITANCE



1N5820 THRU 1N5822

HIGH CURRENT SCHOTTKY BARRIER RECTIFIERS
VOLTAGE - 20 to 40 Volts CURRENT - 3.0 Amperes

FEATURES

- ◆ Low cost
- ◆ Plastic package has Underwriters Laboratory Flammability Classification 94V-O
- ◆ Metal to silicon rectifier, majority carrier conduction
- ◆ Low power loss, high efficiency
- ◆ High current capability, low V_F
- ◆ High surge capacity
- ◆ Epitaxial construction
- ◆ Guard Ring for transient protection
- ◆ For use in low voltage, high frequency inverters, free wheeling, and polarity protection applications.
- ◆ High temperature soldering guaranteed: 250 °C/10 seconds/.375" (9.5 mm) lead lengths at 5 lbs., (2.3 kg) tension

DO-201AD

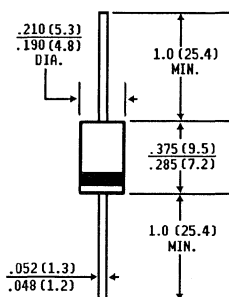

Dimensions in inches
and
(Millimeters)

MECHANICAL DATA

Case: Molded Plastic

Terminals: Axial leads, solderable per MIL-STD-202, Method 208

Polarity: Color band denotes cathode

Mounting Position: Any

Weight: 0.04 ounces, 1.12 gram

MAXIMUM RATINGS AND ELECTRICAL CHARACTERISTICS

Ratings at 25°C ambient temperature unless otherwise specified.

Resistive or inductive load.

For capacitive load, derate current by 20%.

	SYMBOLS	1N5820	1N5821	1N5822	UNITS
*Maximum Recurrent Peak Reverse Voltage	VRRM	20	30	40	Volts
Maximum RMS Voltage	VRMS	14	21	28	Volts
Maximum DC Blocking Voltage	VDC	20	30	40	Volts
*Maximum Average Forward Rectified Current .375", 9.5mm Lead Length $T_L = 95^\circ\text{C}$	$I_{(AV)}$	3.0			Amps
Peak Forward Surge Current, 8.3ms single half sine-wave superimposed on rated load (JEDEC Method) $T_L = 75^\circ\text{C}$	I_{FSM}	80			Amps
Maximum Forward Voltage at 3.0 (Note 1)	V_F	.475	.500	.525	Volts
Maximum Forward Voltage at 9.4 (Note 1)	V_F	.850	.900	.950	Volts
*Maximum Average Reverse Current at Peak Reverse Voltage $T_A = 25^\circ\text{C}$ (Note 1) $T_A = 100^\circ\text{C}$	I_R I_R	2.0 20.0			mA mA
Typical Thermal Resistance (Note 2)	$R_{\theta JL}$	20			°C/W
*Storage and Operating Temperature Range	T_J, T_{STG}	-65 to +125			°C

NOTES:

1. Measured at Pulse Width 300 μ s. Duty Cycle 2%.

2. Thermal Resistance Junction to Lead Vertical PC Board Mounting, .375" (9.5mm) Lead Lengths.

*JEDEC registered values

RATINGS AND CHARACTERISTIC CURVES 1N5820 THRU 1N5822

FIG. 1 — FORWARD CURRENT DERATING CURVE

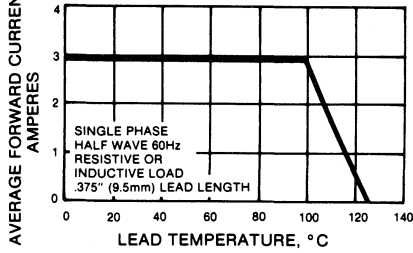

FIG. 3 — MAXIMUM NON-REPETITIVE SURGE CURRENT

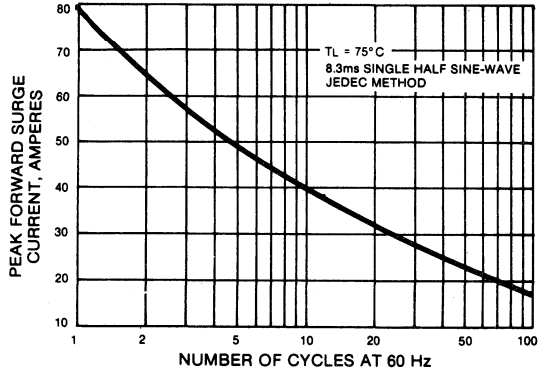

FIG. 2 — TYPICAL REVERSE CHARACTERISTICS

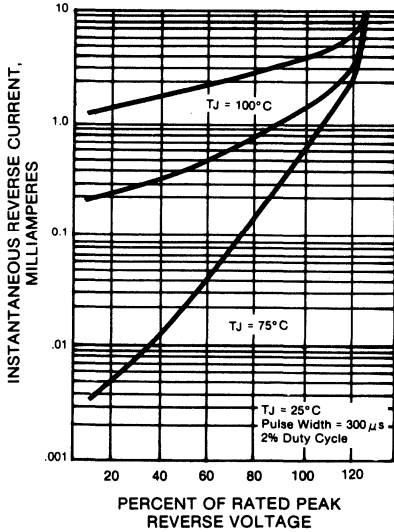

FIG. 4 — TYPICAL FORWARD CHARACTERISTICS

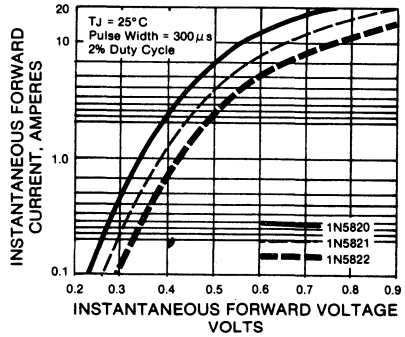
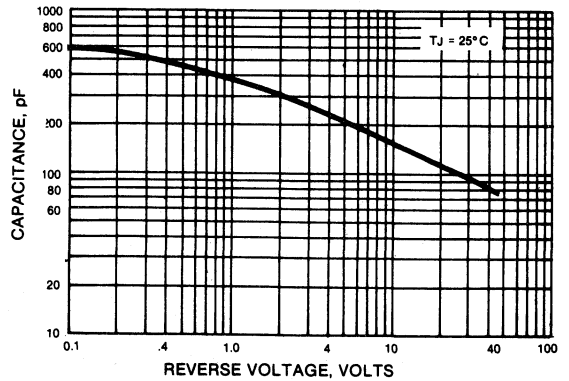

FIG. 5 — TYPICAL JUNCTION CAPACITANCE



SB320 THRU SB360

HIGH CURRENT SCHOTTKY BARRIER RECTIFIERS
VOLTAGE - 20 to 60 Volts CURRENT - 3.0 Amperes

FEATURES

DO-201AD

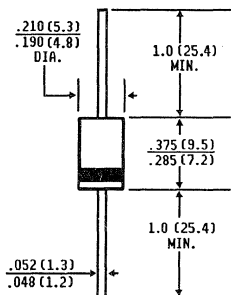

Dimensions in inches
and
(millimeters)

- ◆ Low cost
- ◆ Plastic package has Underwriters Laboratory Flammability Classification 94V-O
- ◆ Metal to silicon rectifier, majority carrier conduction
- ◆ Low power loss, high efficiency
- ◆ High current capability, low V_F
- ◆ High surge capacity
- ◆ Epitaxial construction
- ◆ For use in low voltage, high frequency inverters, free wheeling, and polarity protection applications.
- ◆ Guard Ring for transient protection
- ◆ High temperature soldering guaranteed: 250 °C/10 seconds/.375" (9.5 mm) lead lengths at 5 lbs., (2.3 kg) tension

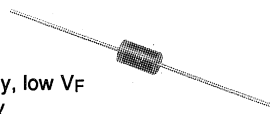

MECHANICAL DATA

Case: Molded Plastic

Terminals: Axial leads, solderable per MIL-STD-202, Method 208

Polarity: Color band denotes cathode

Mounting Position: Any

Weight: 0.012 ounces, .34 gram

MAXIMUM RATINGS AND ELECTRICAL CHARACTERISTICS

Ratings at 25°C ambient temperature unless otherwise specified.
Resistive or inductive load.
For capacitive load, derate current by 20%.

	SYMBOLS	SB320	SB330	SB340	SB350	SB360	UNITS
Maximum Recurrent Peak Reverse Voltage	VRRM	20	30	40	50	60	Volts
Maximum RMS Voltage	VRMS	14	21	28	35	42	Volts
Maximum DC Blocking Voltage	VDC	20	30	40	50	60	Volts
Maximum Average Forward Rectified Current .375", 9.5mm Lead Length	I(AV)	3.0					Amps
Peak Forward Surge Current, 8.3ms single half sine-wave superimposed on rated load (JEDEC Method)	I _{FSM}	80					Amps
Maximum Forward Voltage at 3.0A	V _F	.50		.74		Volts	
Maximum Average Reverse Current at Peak Reverse Voltage T _A = 25°C T _A = 100°C	I _R I _R	0.5 20.0					mA mA
Maximum Thermal Resistance (Note 1)	R _{ΘJL}	20			10		°C/W
Operating Temperature Range	T _J	-65 to +125			-65 to +150		°C
Storage Temperature Range	T _{STG}	-65 to +150					°C

NOTES:

1. Thermal Resistance Junction to Lead Vertical PC Board Mounting, .375" (9.5 mm) Lead Length.

RATINGS AND CHARACTERISTIC CURVES SB320 THRU SB360

FIG. 1 — FORWARD CURRENT DERATING CURVE

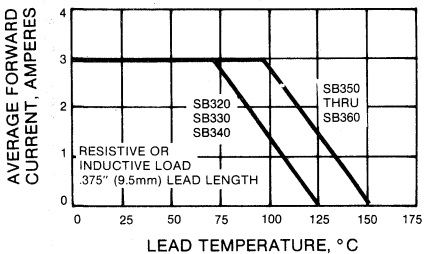

FIG. 3 — TYPICAL REVERSE CHARACTERISTICS

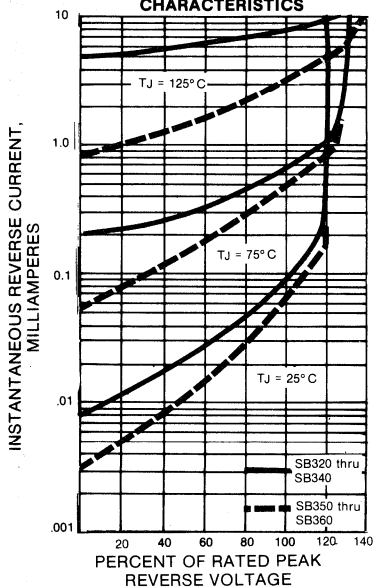

FIG. 2 — TYPICAL INSTANTANEOUS FORWARD CHARACTERISTICS

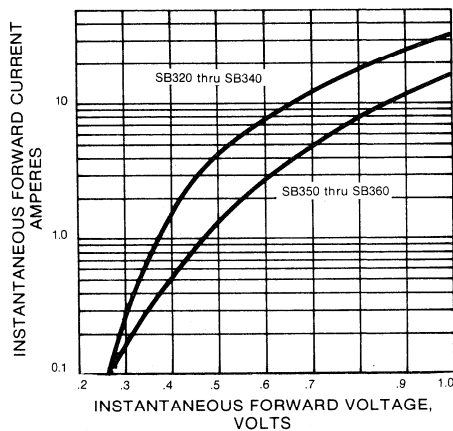

FIG. 4 — TYPICAL JUNCTION CAPACITANCE

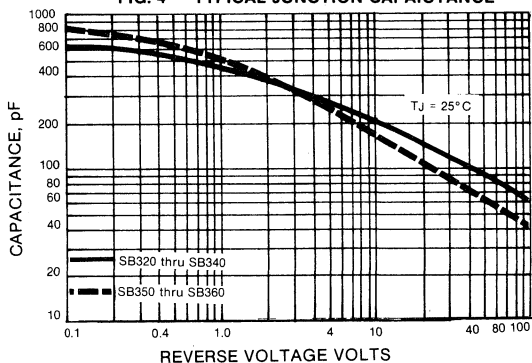
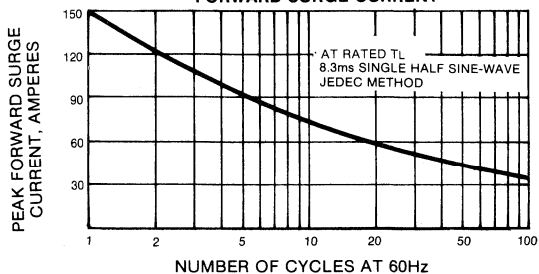

FIG. 5 — MAXIMUM NON-REPETITIVE PEAK FORWARD SURGE CURRENT



SB390 AND SB3100

SCHOTTKY RECTIFIER

VOLTAGE RANGE -90 and 100 Volts CURRENT -3.0 Amperes

FEATURES

- ◆ Plastic package has Underwriters Laboratory Flammability Classifications 94V-O.
- ◆ Metal to silicon rectifier, majority carrier conduction
- ◆ Low power loss, high efficiency
- ◆ High current capability, low V_F
- ◆ High surge capacity
- ◆ Epitaxial construction
- ◆ For use in low voltage, high frequency inverters, free wheeling, and polarity protection applications
- ◆ Guard Ring for transient protection

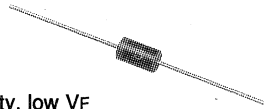

DO-201AD

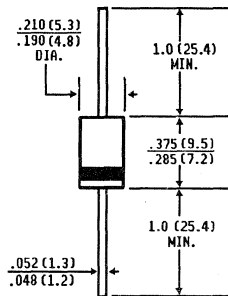

Dimensions in inches
and
(millimeters)

MECHANICAL DATA

Case: DO-201AD Molded Plastic

Terminals: Axial leads, solderable per MIL-STD-202, Method 208

Polarity: Color Band denotes cathode

Mounting Position: Any

Weight: .04 ounces, 1.1 gram

MAXIMUM RATINGS AND ELECTRICAL CHARACTERISTICS

Ratings at 25°C ambient temperature unless otherwise specified. Resistive or inductive load. For capacitive load, derate current by 20%.

	SYMBOLS	SB390	SB3100	UNITS
Maximum Recurrent Peak Reverse Voltage	V_{RRM}	90	100	Volts
Maximum RMS Voltage	V_{RWM}	64	71	Volts
Maximum DC Blocking Voltage	V_{DC}	90	100	Volts
Maximum Average Forward Rectified Current at $T_C = 135^\circ\text{C}$	$I_{(AV)}$	3.0		Amps
Peak Forward Surge Current 8.3ms single half sine-wave superimposed on rated load (JEDEC Method)	I_{FSM}	150		Amps
Peak Repetitive Reverse Surge Current (2.0us, 1KHz)	I_{RSM}	1.0		Amps
Voltage Rate of Change, dv/dt (rated V_R)	$V/\mu\text{s}$	1000		$V/\mu\text{s}$
Maximum Forward Voltage (Note 1) $I_F = 3A, T_L = 25^\circ\text{C}$ $I_F = 3A, T_C = 100^\circ\text{C}$	V_F	0.79	0.69	Volts
Maximum Instantaneous Reverse Current at Peak Reverse Voltage $T_C = 100^\circ\text{C}$ (Note 1)	I_R	.6		mA
Peak Reverse Voltage $T_C = 25^\circ\text{C}$	I_R	0.1		mA
Maximum Thermal Resistance, Junction to Lead	$R_{\theta JL}$	10.0		$^\circ\text{C}/\text{W}$
Maximum Operating Junction Temperature	T_C	-65 to +150		$^\circ\text{C}$
Maximum Storage Temperature	T_{STG}	-65 to +175		$^\circ\text{C}$

NOTES: 1. Pulse Test Pulse Width 300 μs , Duty Cycle 2%.

RATINGS AND CHARACTERISTIC CURVES SB390 THRU SB3100

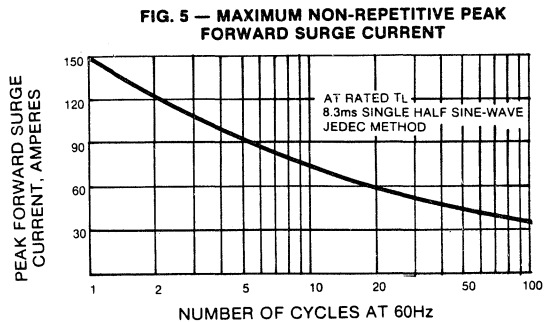
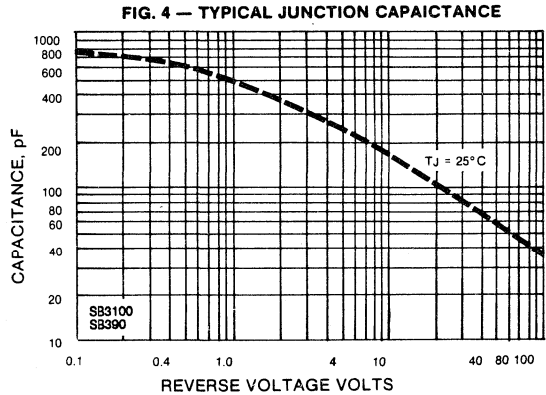
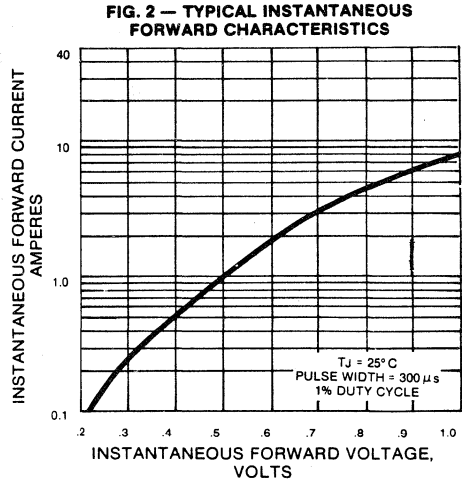
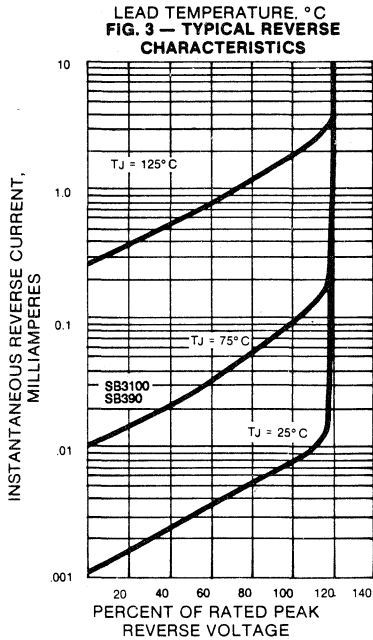
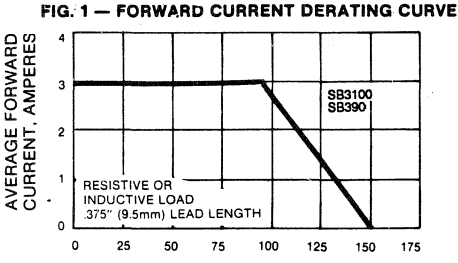

SB520 THRU SB560

HIGH CURRENT SCHOTTKY BARRIER RECTIFIERS
VOLTAGE - 20 to 60 Volts CURRENT - 5.0 Amperes

FEATURES

DO-201AD

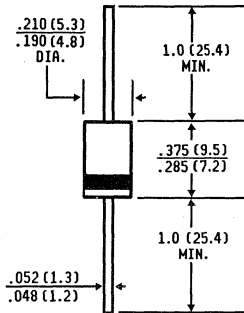

*Dimensions in inches
and
(millimeters)*

- ◆ Low cost
- ◆ Plastic package has Underwriters Laboratory Flammability Classification 94V-O
- ◆ Metal to silicon rectifier, majority carrier conduction
- ◆ Low power loss - high efficiency
- ◆ High current capability, low V_F
- ◆ High surge capacity
- ◆ Epitaxial construction
- ◆ Guard Ring for transient protection
- ◆ For use in low voltage, high frequency inverters, free wheeling, and polarity protection applications.
- ◆ High temperature soldering guaranteed: 250 °C/10 seconds/.375" (9.5 mm) lead lengths at 5 lbs., (2.3 kg) tension

MECHANICAL DATA

Case: Molded Plastic
Terminals: Axial leads, solderable per MIL-STD-202, Method 208
Polarity: Color band denotes cathode
Mounting Position: Any
Weight: 0.012 ounces, .34 gram

MAXIMUM RATINGS AND ELECTRICAL CHARACTERISTICS

Ratings at 25°C ambient temperature unless otherwise specified.
 Resistive or inductive load.
 For capacitive load, derate current by 20%

	SYMBOLS	SB520	SB530	SB540	SB550	SB560	UNITS
Maximum Recurrent Peak Reverse Voltage	VRRM	20	30	40	50	60	Volts
Maximum RMS Voltage	VRMS	14	21	28	35	42	Volts
Maximum DC Blocking Voltage	VDC	20	30	40	50	60	Volts
Maximum Average Forward Rectified Current .375", 9.5mm Lead Length $T_L = 90^\circ\text{C}$	$I_{(AV)}$	5.0					Amps
Peak Forward Surge Current, 8.3ms single half sine-wave superimposed on rated load (JEDEC Method) $T_L = 70^\circ\text{C}$	I_{FSM}	150					Amps
Maximum Forward Voltage at 5.0A	V_F	.55			.67		Volts
Maximum Instantaneous Forward Voltage at DC Blocking Voltage $T_A = 25^\circ\text{C}$ $T_A = 100^\circ\text{C}$	I_R	0.5					mA
	I_R	50.0			25.0		mA
Maximum Thermal Resistance (Note 1)	$R_{\theta JL}$	15			10		°C/W
Operating Temperature Range	T_J	-65 to +125			-65 to +150		°C
Storage and Operating Temperature Range	T_J, T_{STG}	-65 to +125					°C

NOTES:

1. Thermal Resistance Junction to Lead Vertical PC Board Mounting, .375" (9.5mm) Lead Length.

RATINGS AND CHARACTERISTIC CURVES SB520 THRU SB560

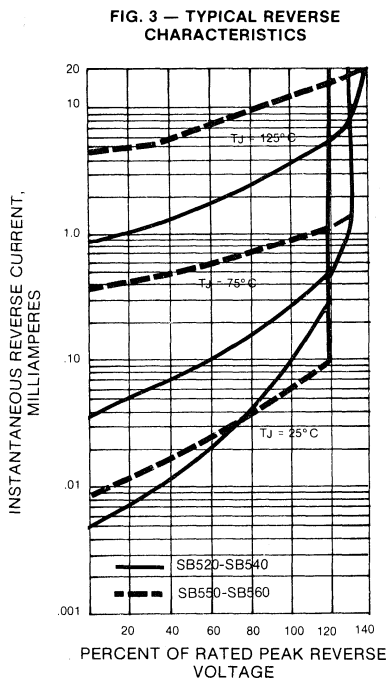
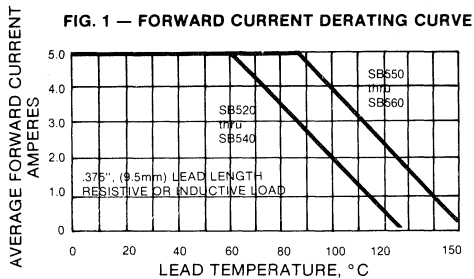

FIG. 2 — MAXIMUM NON-REPETITIVE PEAK FORWARD SURGE CURRENT

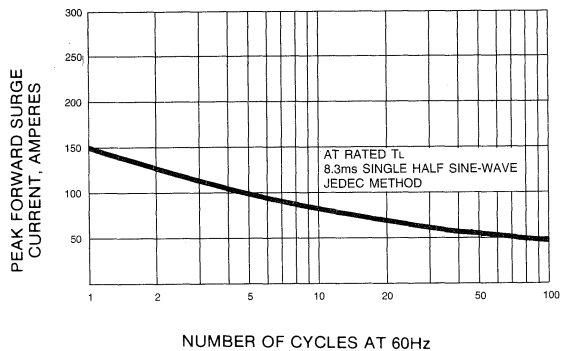

FIG. 4 — TYPICAL INSTANTANEOUS FORWARD CHARACTERISTICS

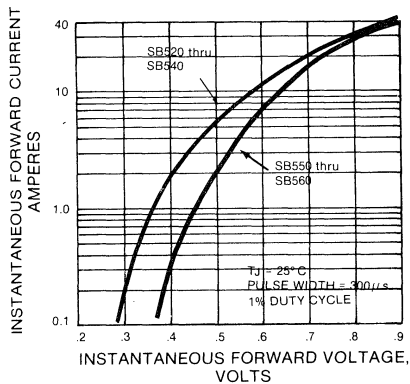
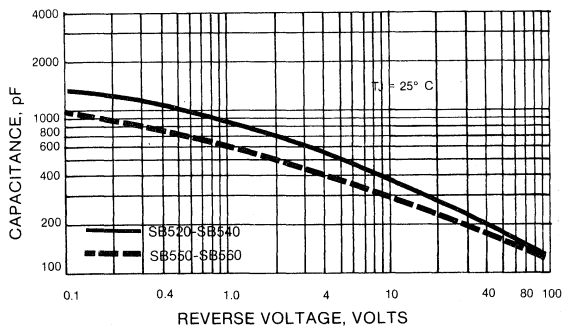

FIG. 5 — TYPICAL JUNCTION CAPACITANCE



SB590 AND SB5100

SCHOTTKY RECTIFIER

VOLTAGE RANGE - 90 and 100 Volts **CURRENT - 5.0 Amperes**

FEATURES

- ◆ Plastic package has Underwriters Laboratory Flammability Classifications 94V-O.
- ◆ Metal to silicon rectifier, majority carrier conduction
- ◆ Low power loss, high efficiency
- ◆ High current capability, low VF
- ◆ High surge capacity
- ◆ Epitaxial construction
- ◆ For use in low voltage, high frequency inverters, free wheeling, and polarity protection applications
- ◆ Guard Ring for transient protection

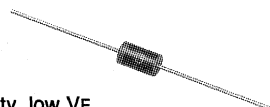

DO-201AD

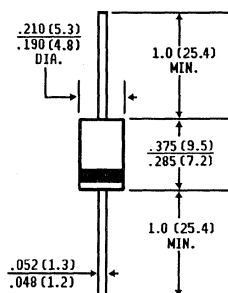

Dimensions in inches
and
(millimeters)

MECHANICAL DATA

Case: DO-201AD Molded Plastic

Terminals: Axial leads, solderable per MIL-STD- 202, Method 208

Polarity: Color Band denotes cathode

Mounting Position: Any

Weight: .04 ounces, 1.1 gram

MAXIMUM RATINGS AND ELECTRICAL CHARACTERISTICS

Ratings at 25°C ambient temperature unless otherwise specified. Resistive or inductive load. For capacitive load, derate current by 20%.

	SYMBOLS	SB590	SB5100	UNITS
Maximum Recurrent Peak Reverse Voltage	V _{RRM}	90	100	Volts
Maximum RMS Voltage	V _{RWM}	64	71	Volts
Maximum DC Blocking Voltage	V _{DC}	90	100	Volts
Maximum Average Forward Rectified Current at .375" (9.5 mm) lead length, see fig. 1	I _(AV)	5.0		Amps
Peak Forward Surge Current 8.3ms single half sine-wave superimposed on rated load (JEDEC Method)	I _{FSM}	150		Amps
Peak Repetitive Reverse Surge Current (2.0us, 1KHz)	I _{RSM}	1.0		Amps
Voltage Rate of Change, dv/dt (rated V _R)	V/μs	1000		V/μs
Maximum Forward Voltage (Note 1) I _F = 5A, T _L = 25°C I _F = 5A, T _C = 100°C	V _F	0.79	0.69	Volts
Maximum Instantaneous Reverse Current at Peak Reverse Voltage T _C = 100°C (Note 1)	I _R	20.0		mA
Peak Reverse Voltage T _C = 25°C	I _R	0.6		mA
Maximum Thermal Resistance, Junction to Lead	RθJL	15.0		°C/W
Maximum Operating Junction Temperature	T _C	-65 to +150		°C
Maximum Storage Temperature	T _{STG}	-65 to +175		°C

NOTES: 1. Pulse Test Pulse Width 300 μs, Duty Cycle 2%.

RATINGS AND CHARACTERISTIC CURVES SB590 AND SB5100

FIG. 1 — FORWARD CURRENT DERATING CURVE

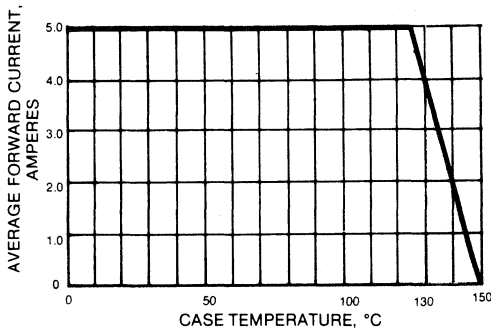

FIG. 2 — TYPICAL REVERSE CHARACTERISTICS

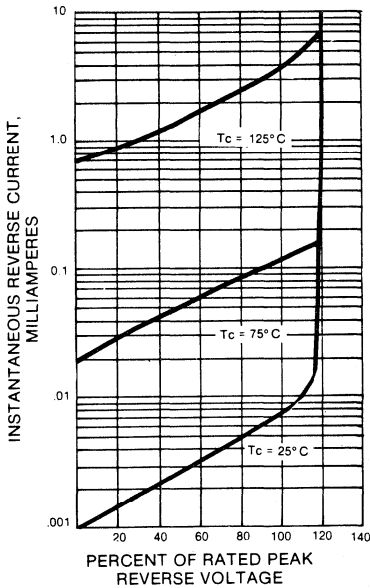

FIG. 3 — MAXIMUM NON-REPETITIVE FORWARD SURGE CURRENT

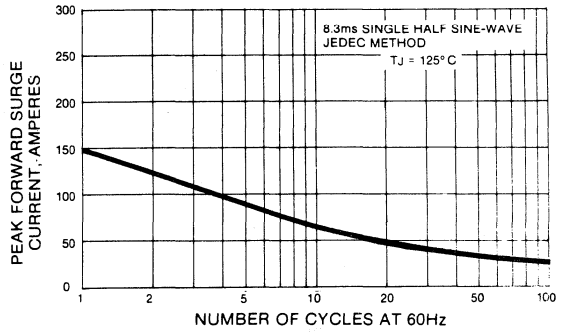

FIG. 4 — TYPICAL INSTANTANEOUS FORWARD CHARACTERISTICS

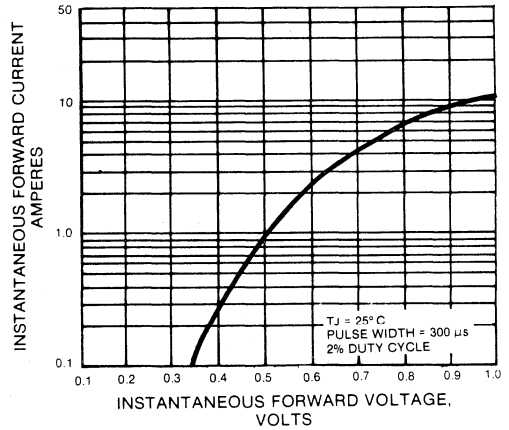
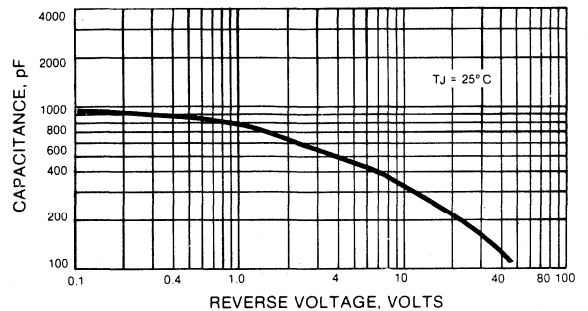

FIG. 5 — TYPICAL JUNCTION CAPACITANCE



MEDIUM CURRENT SCHOTTKY RECTIFIERS

5 TO 40 AMPERES

**SEE
NEW
ISOLATED
PACKAGES**



**GENERAL
INSTRUMENT**

SBLF530 AND SBLF540

SCHOTTKY RECTIFIER

VOLTAGE RANGE - 30 and 40 Volts CURRENT - 5.0 Amperes

FEATURES

- ◆ Isolated Plastic package has Underwriters Laboratory Flammability Classifications 94V-0
- ◆ Metal to silicon rectifier, majority carrier conduction
- ◆ Low power loss, high efficiency
- ◆ High current capability, low V_F
- ◆ High surge capacity
- ◆ Epitaxial construction
- ◆ For use in low voltage, high frequency inverters, free wheeling, and polarity protection applications
- ◆ High temperature soldering guaranteed: 250°C/10 seconds/.25", (6.35mm) from case
- ◆ Guard Ring for transient protection
- ◆ Internal Insulation: 1.5K VRMS

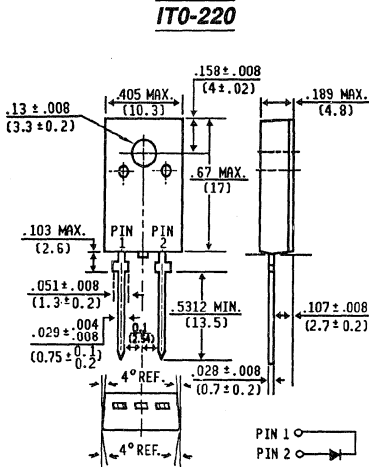
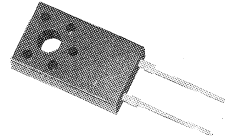

Dimensions in inches
and
(millimeters)

MECHANICAL DATA

Case: ITO-220 Molded Plastic

Terminals: Solderable per MIL-STD-202, Method 208

Polarity: As marked

Mounting Position: Any

Mounting Torque: 5 in. - lb. max.

Weight: .08 ounces, 2.24 grams

MAXIMUM RATINGS AND CHARACTERISTICS

Ratings at 25°C ambient temperature unless otherwise specified.
Resistive or inductive load. For capacitive or inductive load, derate current by 20%.

	SYMBOLS	SBLF530	SBLF540	UNITS
Maximum Recurrent Peak Reverse Voltage	V_{RRM}	30	40	Volts
Maximum RMS Voltage	V_{RMS}	21	28	Volts
Maximum DC Blocking Voltage	V_{DC}	30	40	Volts
Maximum Average Forward Rectified Current See Fig.1	$I_{(AV)}$	5.0		Amps
Peak Forward Surge Current, 8.3ms single half sine-wave superimposed on rated load (JEDEC Method)	I_{FSM}	175		Amps
Maximum Instantaneous Forward Voltage at 5.0A, See Fig. 1	V_F	.55		Volts
Maximum Average Reverse Current at $T_c = 25^\circ\text{C}$ Rated Peak Reverse Voltage $T_c = 100^\circ\text{C}$	I_R	0.5 33.0		mA
Typical Thermal Resistance (Note 1)	$R_{\theta JC}$	3.5		$^\circ\text{C/W}$
Operating and Storage Temperature Range	T_J, T_{STG}	-40 to +125		$^\circ\text{C}$

NOTES:

1. Thermal Resistance from Junction to Case.
2. 300 μs Pulse Width, 2% Duty Factor.

RATINGS AND CHARACTERISTIC CURVES SBLF530 AND SBLF540

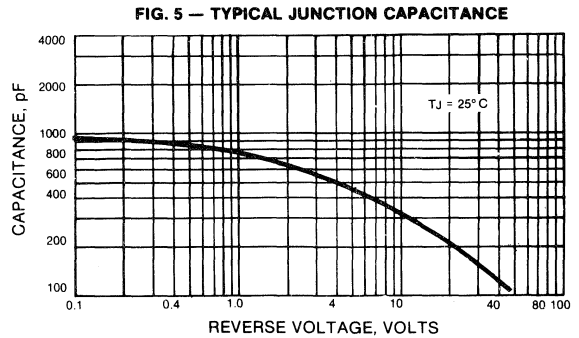
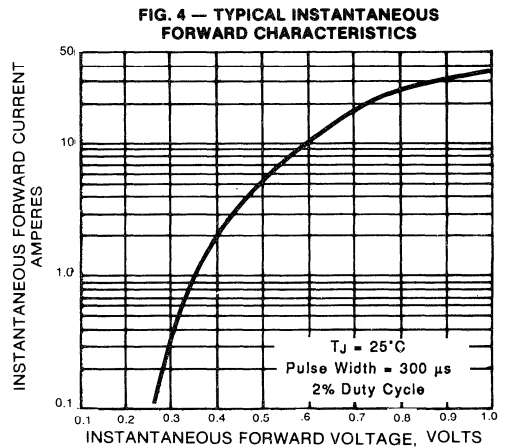
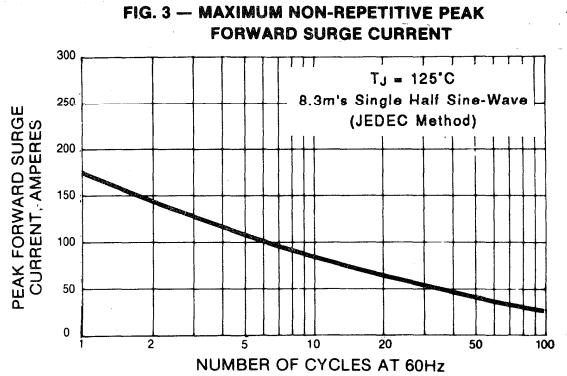
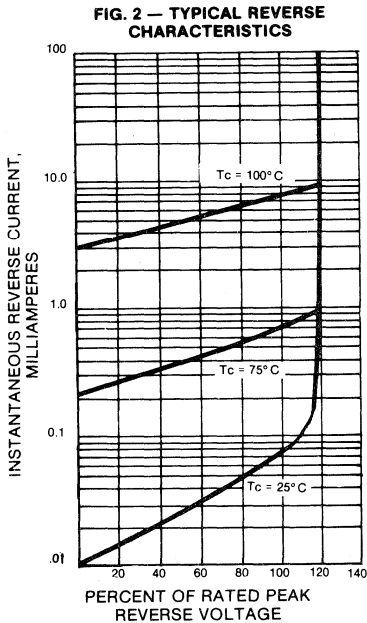
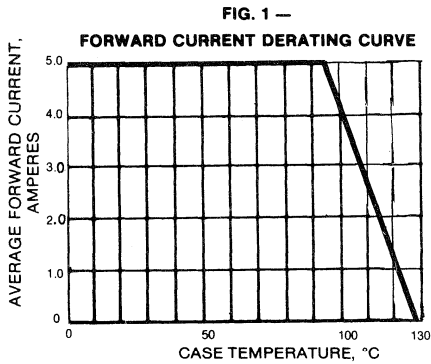

SBL530 AND SBL540

SCHOTTKY RECTIFIER
VOLTAGE RANGE - 30 and 40 Volts CURRENT - 5.0 Amperes

FEATURES

- ◆ Plastic package has Underwriters Laboratory Flammability Classifications 94V-O.
- ◆ Metal to silicon rectifier, majority carrier conduction
- ◆ Low power loss, high efficiency
- ◆ High current capability, low V_F
- ◆ High surge capacity
- ◆ Epitaxial construction
- ◆ For use in low voltage, high frequency inverters, free wheeling, and polarity protection applications
- ◆ High temperature soldering guaranteed: 250°C/10 seconds/.25", (6.35mm) from case
- ◆ Guard Ring for transient protection

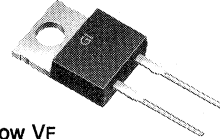

TO-220

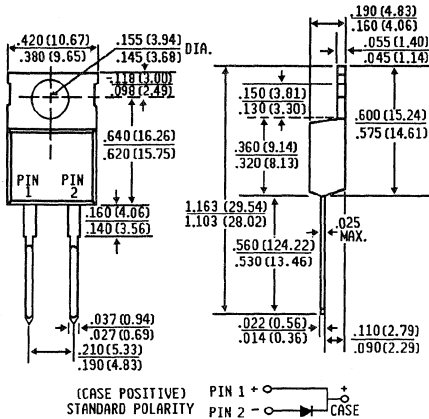

Dimensions in inches
 and
 (millimeters)

MECHANICAL DATA

Case: TO-220 Molded Plastic

Terminals: Solderable per MIL-STD-202, Method B08

Polarity: As marked

Mounting Position: Any

Weight: .08 ounces, 2.24 gram

CROSS REFERENCE GUIDE

GI	FUJI	SHINDENGEN
SBL530	---	S5S3M
SBL540	ERC80-004	S5S4M

MAXIMUM RATINGS AND CHARACTERISTICS

Ratings at 25°C ambient temperature unless otherwise specified.
 Resistive or inductive load. For capacitive or inductive load, derate current by 20%.

	SYMBOLS	SBL530	SBL540	UNITS
Maximum Recurrent Peak Reverse Voltage	V_{RRM}	30	40	Volts
Maximum RMS Voltage	V_{RMS}	21	28	Volts
Maximum DC Blocking Voltage	V_{DC}	30	40	Volts
Maximum Average Forward Rectified Current at $T_C = 114^\circ\text{C}$	$I_{(AV)}$	5.0		Amps
Peak Forward Surge Current, 8.3ms single half sine-wave superimposed on rated load (JEDEC Method)	IFSM	175		Amps
Maximum Instantaneous Forward Voltage at 5.0A, $T_C = 25^\circ\text{C}$ (Note 2)	V_F	.55		Volts
Maximum Average Reverse Current at $T_C = 25^\circ\text{C}$ Rated Peak Reverse Voltage (Note 3) $T_C = 100^\circ\text{C}$	I_R	0.5	33.0	mA
Typical Thermal Resistance (Note 1)	$R_{\theta JC}$	3.0		$^\circ\text{C/W}$
Operating and Storage Temperature Range	T_J, T_{STG}	-40 to +125		$^\circ\text{C}$

NOTES:

1. Thermal Resistance from Junction to Case.
2. 300 μs Pulse Width, 2% Duty Factor.

RATINGS AND CHARACTERISTIC CURVES SBL530 AND SBL540

FIG. 1 — FORWARD CURRENT DERATING CURVE

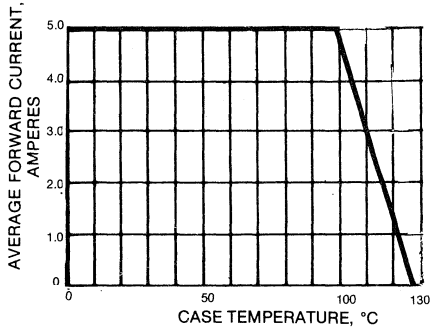

FIG. 2 — TYPICAL REVERSE CHARACTERISTICS

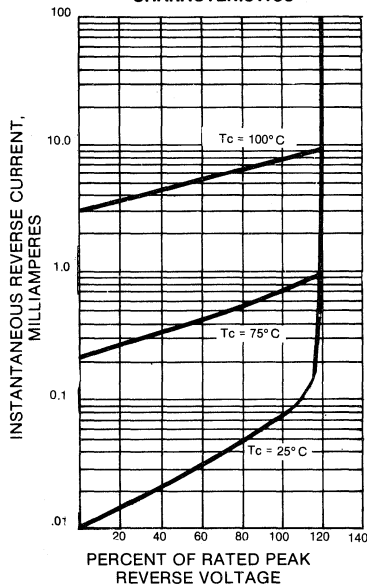

FIG. 3 — MAXIMUM NON-REPETITIVE PEAK FORWARD SURGE CURRENT

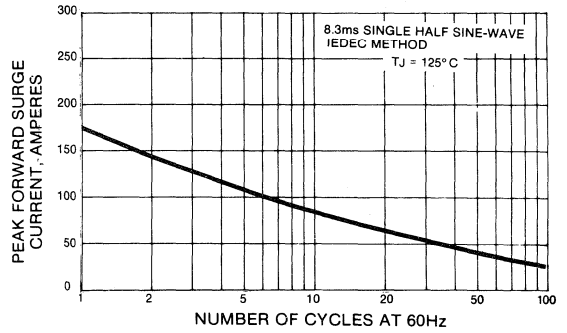

FIG. 4 — TYPICAL INSTANTANEOUS FORWARD CHARACTERISTICS

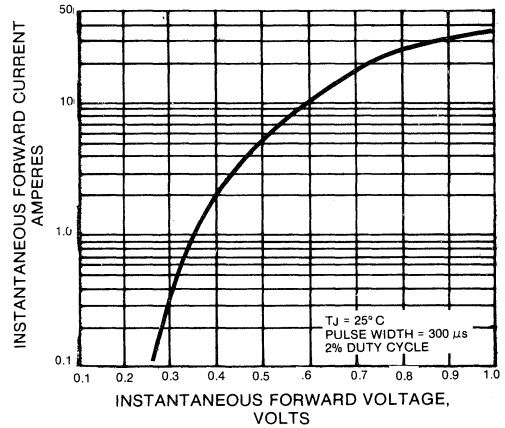
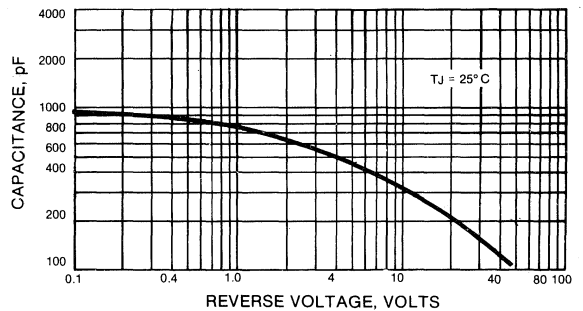

FIG. 5 — TYPICAL JUNCTION CAPACITANCE



SBLF530CT AND SBLF540CT

SCHOTTKY RECTIFIER

VOLTAGE RANGE - 30 and 40 Volts CURRENT - 5.0 Amperes

FEATURES

- ◆ Isolated Plastic package has Underwriters Laboratory Flammability Classifications 94V-0
- ◆ Metal to silicon rectifier, majority carrier conduction
- ◆ Low power loss, high efficiency
- ◆ High current capability, low V_F
- ◆ High surge capacity
- ◆ Epitaxial construction
- ◆ For use in low voltage, high frequency inverters, free wheeling, and polarity protection applications
- ◆ High temperature soldering guaranteed: 250°C/10 seconds/.25", (6.35mm) from case
- ◆ Guard Ring for transient protection
- ◆ Internal Insulation: 1.5k VRMS

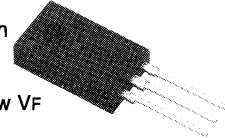

ITO-220 CT

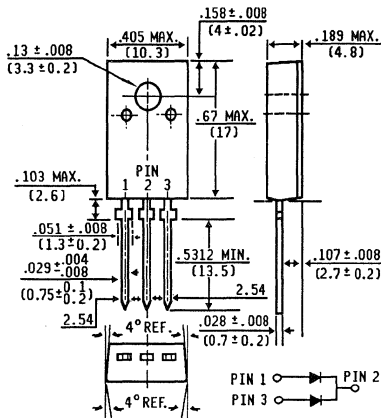

Dimensions in inches
and
(millimeters)

MECHANICAL DATA

Case: ITO-220 Molded Plastic

Terminals: Solderable per MIL-STD-202, Method 208

Polarity: As marked

Mounting Position: Any

Mounting Torque: 5 in. - lb. max.

Weight: .08 ounces, 2.24 grams

MAXIMUM RATINGS AND ELECTRICAL CHARACTERISTICS

Ratings at 25 °C ambient temperature unless otherwise specified.
Resistive or inductive load.
For capacitive or inductive load, derate current by 20%.

	SYMBOLS	SBLF530CT	SBLF540CT	UNITS
Maximum Recurrent Peak Reverse Voltage	V_{RRM}	30	40	Volts
Maximum RMS Voltage	V_{RMS}	21	28	Volts
Maximum DC Blocking Voltage	V_{DC}	30	40	Volts
Maximum Average Forward Rectified Current See Fig. 1	$I_{(AV)}$	5.0		Amps
Peak Forward Surge Current, 8.3ms single half sine-wave superimposed on rated load (JEDEC Method)	I_{FSM}	100		Amps
Maximum Instantaneous Forward Voltage Per Leg $I_F = 2.5A, T_c = 25^\circ C$ (Note 2)	V_F	.55		Volts
Maximum Average Reverse Current at $T_c = 25^\circ C$ Rated DC Blocking Voltage per element $T_c = 100^\circ C$	I_R	0.5		mA
Typical Thermal Resistance (Note 1)	$R_{\theta JC}$	3.5		°C/W
Operating Temperature Range	T_c	-40 to +125		°C
Storage Temperature Range	T_{STG}	-40 to +150		°C

NOTES:

1. Thermal Resistance from Junction to Case per element.
2. 300 μs Pulse Width, 2% Duty Factor.

RATINGS AND CHARACTERISTIC CURVES SBLF530CT AND SBLF540CT

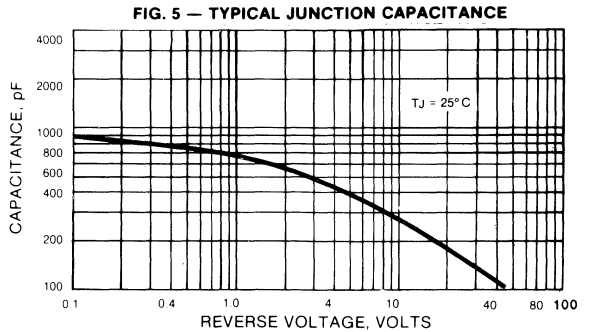
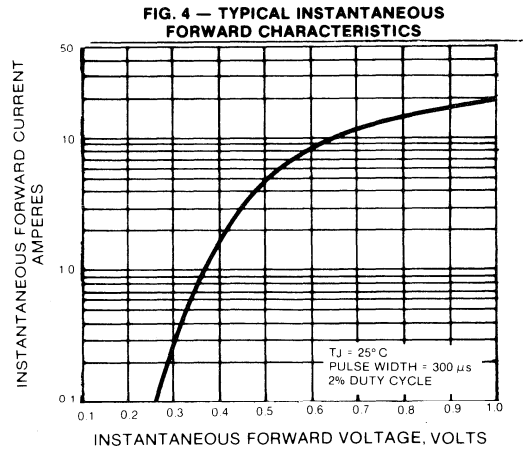
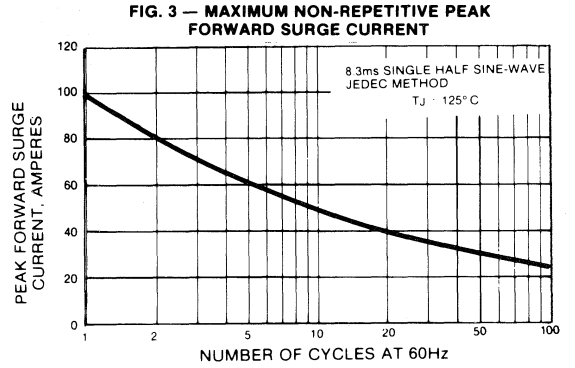
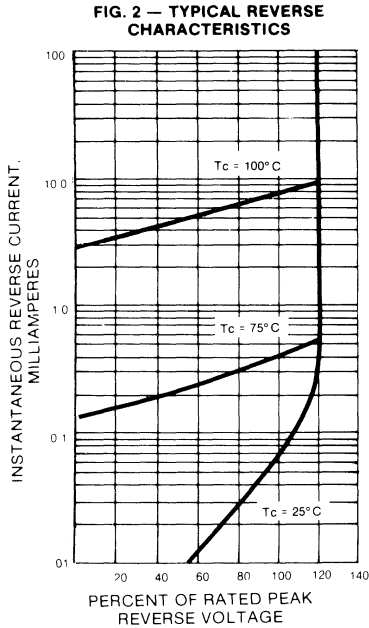
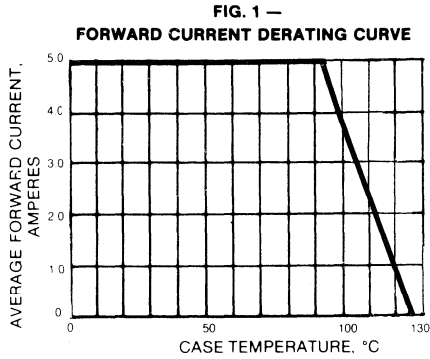

MBRF735 AND MBRF745

SCHOTTKY RECTIFIER

VOLTAGE RANGE - 35 and 45 Volts CURRENT - 7.5 Amperes

FEATURES

- ◆ Isolated plastic package has Underwriters Laboratory Flammability Classifications 94V-O
- ◆ Metal to silicon rectifier, majority carrier conduction
- ◆ Low power loss, high efficiency
- ◆ High current capability, low VF
- ◆ High surge capacity
- ◆ Epitaxial construction
- ◆ For use in low voltage, high frequency inverters, free wheeling, and polarity protection applications
- ◆ High temperature soldering guaranteed: 250°C/10 seconds/.25", (6.35mm) from case
- ◆ Guard Ring for transient protection
- ◆ Internal Insulation: 1.5k VRMS

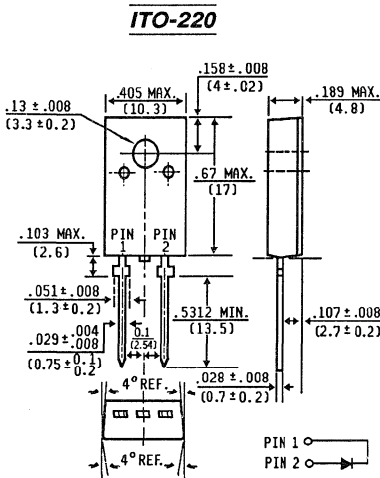
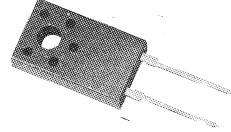

Dimensions in inches and (millimeters)

MECHANICAL DATA

Case: ITO-220 Molded Plastic
Terminals: Solderable per MIL-STD-202, Method 208
Polarity: As marked
Mounting Position: Any
Mounting Torque: 5 in. - lb. max.
Weight: .08 ounces, 2.24 grams

MAXIMUM RATINGS AND ELECTRICAL CHARACTERISTICS

Ratings at 25°C ambient temperature unless otherwise specified. Resistive or inductive load. For capacitive or inductive load, derate current by 20%.

	SYMBOLS	MBRF735	MBRF745	UNITS
Maximum Recurrent Peak Reverse Voltage	V _{RRM}	35	45	Volts
Maximum RMS Voltage	V _{RMS}	25	32	Volts
Maximum DC Blocking Voltage	V _{DC}	35	45	Volts
Maximum Average Forward Rectified Current see Fig. 1	I _(AV)	7.5		Amps
Peak Forward Surge Current, 8.3ms single half sine-wave superimposed on rated load (JEDEC Method)	I _{FSM}	150		Amps
Peak Repetitive Reverse Surge Current (Note 3)	I _{RRM}	1.0		Amps
Maximum Instantaneous Forward Voltage I _F = 7.5A, T _C = 125°C I _F = 15A, T _C = 125°C I _F = 15A, T _C = 25°C	V _F	0.57 0.72 0.84		Volts
Maximum Instantaneous Reverse Current at Rated DC Blocking Voltage per element T _C =125°C	I _R	15		mA
Maximum Instantaneous Reverse Current at Rated DC Blocking Voltage (Note 2) T _C = 25°C	I _R	0.1		mA
Voltage Rate of Change	dv/dt	1000		V/μs
Typical Thermal Resistance, (Note 1)	RθJC	3.5		°C/W
Maximum Operating Junction Temperature	T _J	-65 to +150		°C
Maximum Storage Temperature	T _{STG}	-65 to +175		°C

NOTES: 1. Thermal Resistance Junction to Case.
 2. 300μs Pulse Width, 2% Duty Factor.
 3. 2.0μs, 1.0 KHz.

RATINGS AND CHARACTERISTIC CURVES MBRF735 AND MBRF745

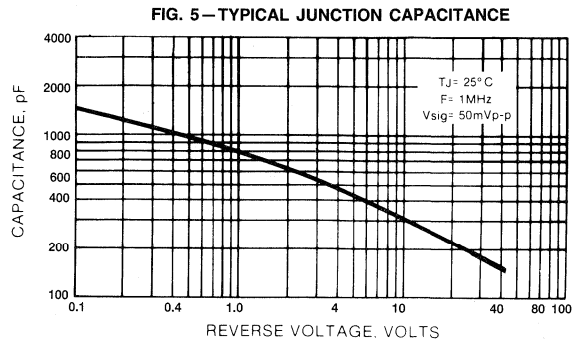
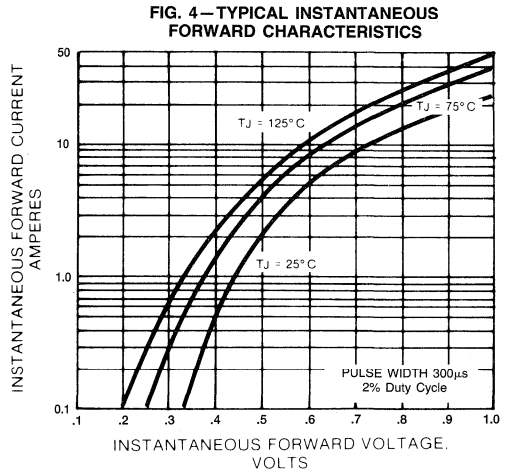
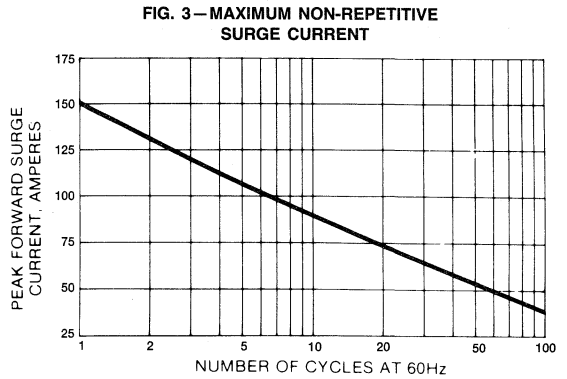
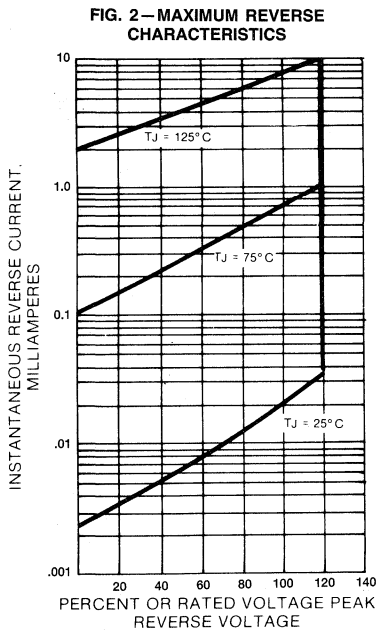
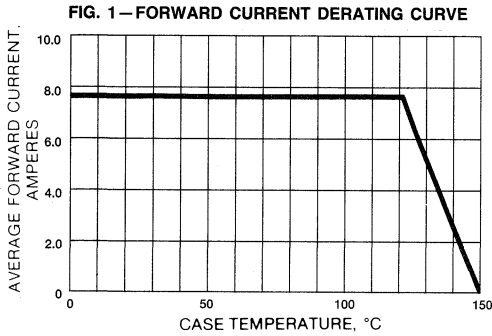

MBRF750 AND MBRF760

SCHOTTKY RECTIFIER

VOLTAGE RANGE - 50 and 60 Volts CURRENT - 7.5 Amperes

FEATURES

- ◆ isolated plastic package has Underwriters Laboratory Flammability Classifications 94V-0
- ◆ Metal to silicon rectifier, majority carrier conduction
- ◆ Low power loss, high efficiency
- ◆ High current capability, low VF
- ◆ High surge capacity
- ◆ Epitaxial construction
- ◆ For use in low voltage, high frequency inverters, free wheeling, and polarity protection applications
- ◆ High temperature soldering guaranteed: 250°C/10 seconds/.25", (6.35mm) from case
- ◆ Guard Ring for transient protection
- ◆ Internal Insulation: 1.5k VRMS

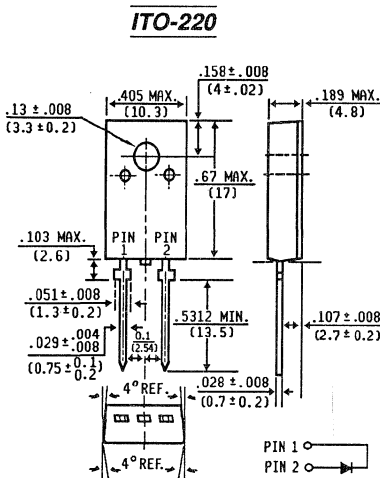
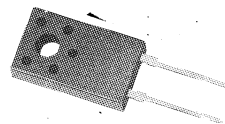

Dimensions in inches and (millimeters)

MECHANICAL DATA

Case: ITO-220 Molded Plastic

Terminals: Solderable per MIL-STD-202, Method 208

Polarity: As marked

Mounting Position: Any

Mounting Torque: 5 in. - lb. max.

Weight: .08 ounces, 2.24 grams

MAXIMUM RATINGS AND ELECTRICAL CHARACTERISTICS

Ratings at 25°C ambient temperature unless otherwise specified. Resistive or inductive load. For capacitive or inductive load, derate current by 20%.

	SYMBOLS	MBRF750	MBRF760	UNITS
Maximum Recurrent Peak Reverse Voltage	V _{RRM}	50	60	Volts
Maximum RMS Voltage	V _{RMS}	35	42	Volts
Maximum DC Blocking Voltage	V _{DC}	50	60	Volts
Maximum Average Forward Rectified Current see Fig. 1	I _(AV)	7.5		Amps
Peak Forward Surge Current, 8.3ms single half sine-wave superimposed on rated load (JEDEC Method)	I _{FSM}	150		Amps
Peak Repetitive Reverse Surge Current (Note 3)	I _{RRM}	.75		Amps
Maximum Instantaneous Forward Voltage I _F = 7.5A, T _C = 125°C I _F = 7.5A, T _C = 25°C	V _F	0.65 0.75		Volts
Maximum Instantaneous Reverse Current at Rated DC Blocking Voltage per element T _C = 100°C	I _R	50		mA
Maximum Instantaneous Reverse Current at Rated DC Blocking Voltage (Note 2) T _C = 25°C	I _R	0.5		mA
Voltage Rate of Change	dv/dt	1000		V/μs
Typical Thermal Resistance, (Note 1)	R _{θJC}	3.5		°C/W
Maximum Operating Junction Temperature	T _J	-65 to +150		°C
Maximum Storage Temperature	T _{STG}	-65 to +175		°C

NOTES:

1. Thermal Resistance Junction to Case.
2. 300μs Pulse Width, 2% Duty Factor.
3. 2.0μs, 1.0 KHz.

RATINGS AND CHARACTERISTIC CURVES MBRF750 AND MBRF760

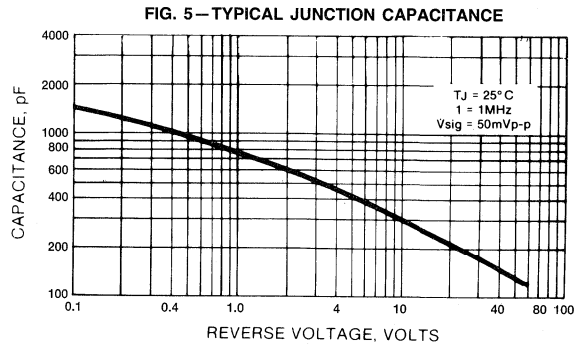
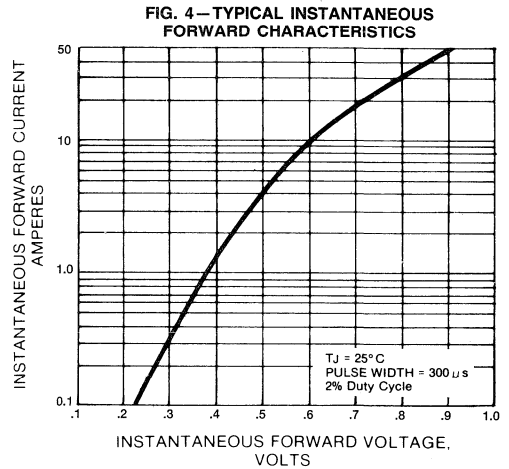
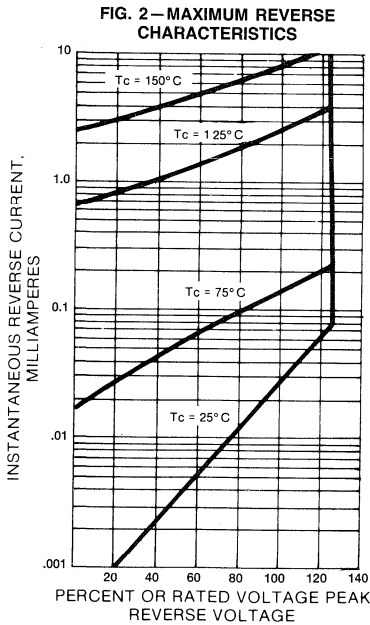
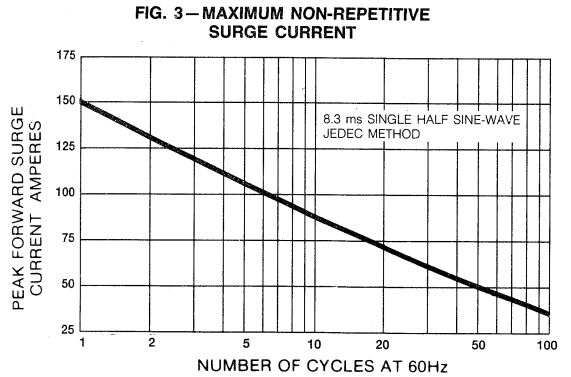
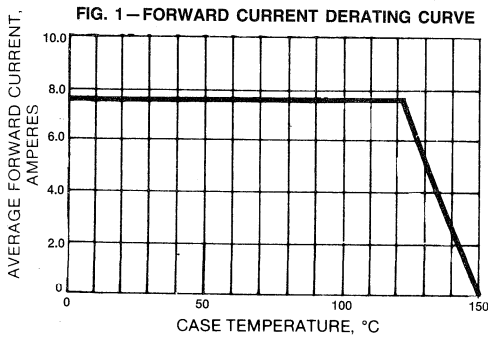

MBR735 AND MBR745

SCHOTTKY RECTIFIER

VOLTAGE RANGE - 35 and 45 Volts CURRENT - 7.5 Amperes

FEATURES

- ◆ Plastic package has Underwriters Laboratory Flammability Classifications 94V-O.
- ◆ Metal to silicon rectifier, majority carrier conduction
- ◆ Low power loss, high efficiency
- ◆ High current capability, low Vf
- ◆ High surge capacity
- ◆ Epitaxial construction
- ◆ For use in low voltage, high frequency inverters, free wheeling, and polarity protection applications
- ◆ High temperature soldering guaranteed: 250°C/10 seconds/.25", (6.35mm) from case
- ◆ Guard Ring for transient protection

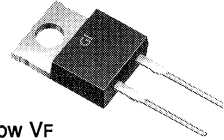

TO-220

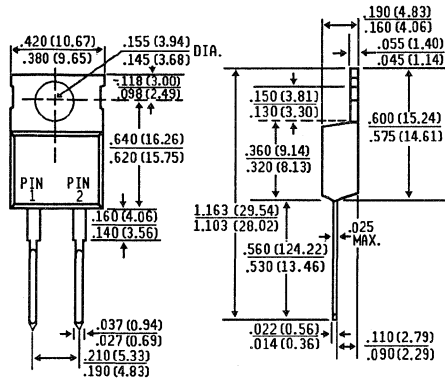

(CASE POSITIVE) PIN 1 +
STANDARD POLARITY PIN 2 - CASE

Dimensions in inches and (millimeters)

MECHANICAL DATA

Case: TO-220 Molded Plastic

Terminals: Solderable per MIL-STD- 202, Method 208

Polarity: As marked

Mounting Position: Any

Weight: .08 ounces, 2.24 gram

MAXIMUM RATINGS AND ELECTRICAL CHARACTERISTICS

Ratings at 25°C ambient temperature unless otherwise specified. Resistive or inductive load. For capacitive load, derate current by 20%.

	SYMBOLS	MBR735	MBR745	UNITS
Maximum Recurrent Peak Reverse Voltage	V _{RRM}	35	45	Volts
Maximum RMS Voltage	V _{RMS}	24.5	31.5	Volts
Maximum DC Blocking Voltage	V _{DC}	35	45	Volts
Maximum Average Forward Rectified Current see Fig. 1	I _(AV)	7.5		Amps
Peak Forward Surge Current, 8.3ms single half sine-wave superimposed on rated load (JEDEC Method)	I _{FSM}	150		Amps
Peak Repetitive Reverse Surge Current (Note 3)	I _{RRM}	1.0		Amps
Maximum Instantaneous Forward Voltage I _F = 7.5A, T _C = 125°C I _F = 15A, T _C = 125°C I _F = 15A, T _C = 25°C	V _F	0.57 0.72 0.84		Volts
Maximum Instantaneous Reverse Current at Rated DC Blocking Voltage per element T _C =125°C	I _R	15		mA
Maximum Instantaneous Reverse Current at Rated DC Blocking Voltage (Note 2) T _C = 25°C	I _R	0.1		mA
Voltage Rate of Change	dv/dt	1000		V/μs
Typical Thermal Resistance, (Note 1)	R _{θJC}	3.0		°C/W
Maximum Operating Junction Temperature	T _J	-65 to +150		°C
Maximum Storage Temperature	T _{STG}	-65 to +175		°C

NOTES:

1. Thermal Resistance Junction to CASE.
2. 300μs Pulse Width, 2% Duty Factor.
3. 2.0μs, 1.0 KHz.

RATINGS AND CHARACTERISTIC CURVES MBR735 AND MBR745

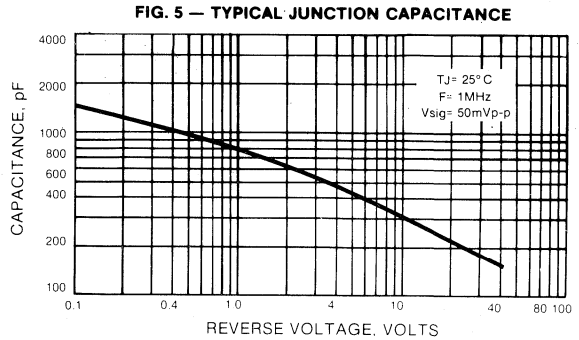
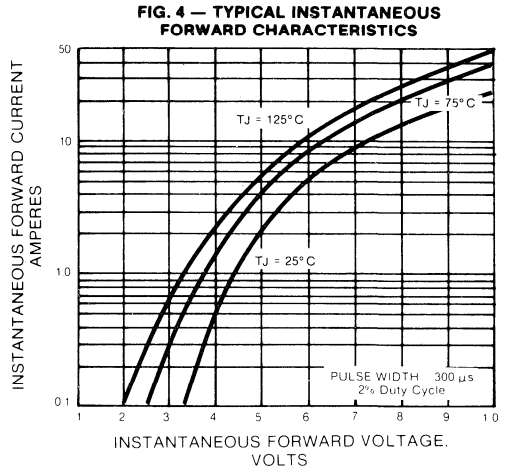
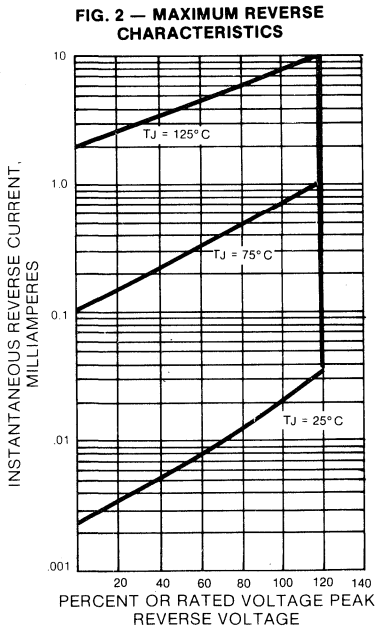
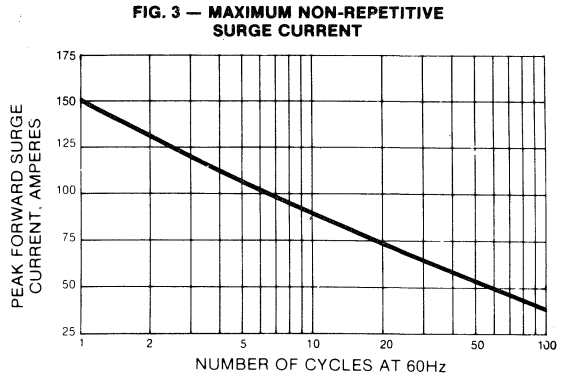
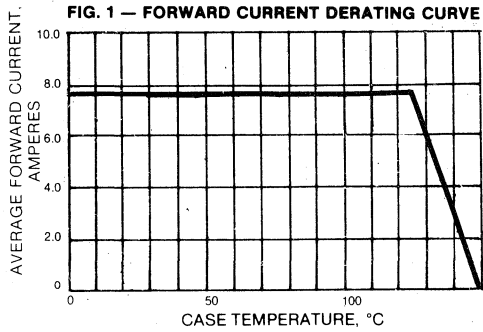

MBR750 AND MBR760

SCHOTTKY RECTIFIER

VOLTAGE RANGE - 50 and 60 Volts CURRENT - 7.5 Amperes

FEATURES

TO-220

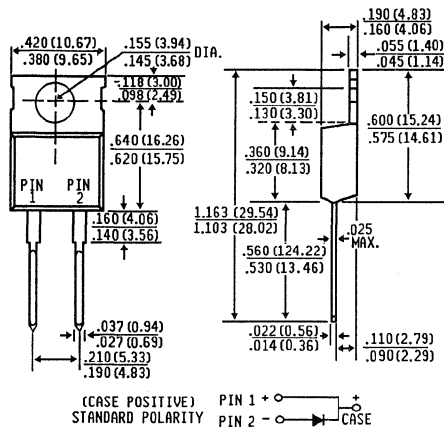

Dimensions in inches
and
(millimeters)

- ◆ Plastic package has Underwriters Laboratory Flammability Classifications 94V-O.
- ◆ Metal to silicon rectifier, majority carrier conduction
- ◆ Low power loss, high efficiency
- ◆ High current capability, low Vf
- ◆ High surge capacity
- ◆ Epitaxial construction
- ◆ For use in low voltage, high frequency inverters, free wheeling, and polarity protection applications
- ◆ High temperature soldering guaranteed: 250°C/10 seconds/.25", (6.35mm) from case
- ◆ Guard Ring for transient protection

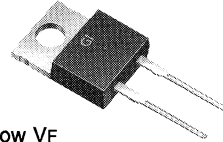

MECHANICAL DATA

Case: TO-220 Molded Plastic

Terminals: Solderable per MIL-STD- 202, Method 208

Polarity: As marked

Mounting Position: Any

Weight: .08 ounces, 2.24 gram

MAXIMUM RATINGS AND ELECTRICAL CHARACTERISTICS

Ratings at 25 °C ambient temperature unless otherwise specified.

Resistive or inductive load.

For capacitive or inductive load, derate current by 20%.

	SYMBOLS	MBR750	MBR760	UNITS
Maximum Recurrent Peak Reverse Voltage	V _{RRM}	50	60	Volts
Maximum RMS Voltage	V _{RMS}	35	42	Volts
Maximum DC Blocking Voltage	V _{DC}	50	60	Volts
Maximum Average Forward Rectified Current See Fig. 1	I _(AV)	7.5		Amps
Peak Forward Surge Current, 8.3ms single half sine-wave superimposed on rated load (JEDEC Method)	I _{FSM}	150		Amps
Maximum Instantaneous Forward Voltage (Note 2) I _F = 7.5A, T _C = 125°C I _F = 7.5, T _C = 25°C	V _F	.65 .75		Volts
Maximum Average Reverse Current at T _C = 25°C Rated Peak Reverse Voltage (Note 2) T _C = 100°C	I _R	0.5 50.0		mA
Typical Thermal Resistance (Note 1)	R _{θJC}	3.0		°C/W
Maximum Operating Storage Temperature Range	T _C , T _{STG}	-65 to +175		°C

NOTES:

1. Thermal Resistance from Junction to Case.

2. 300 μs Pulse Width, 2% Duty Factor.

RATINGS AND CHARACTERISTIC CURVES MBR750 AND MBR760

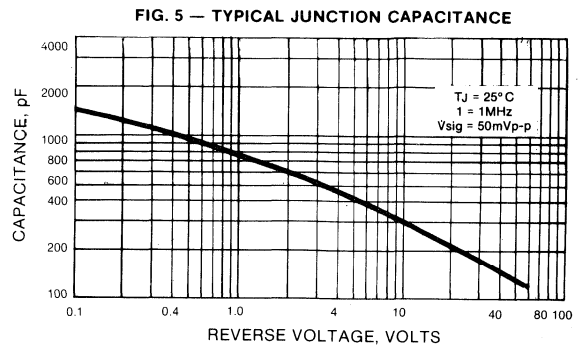
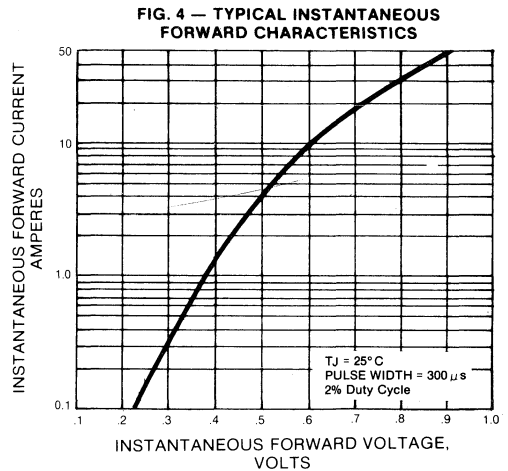
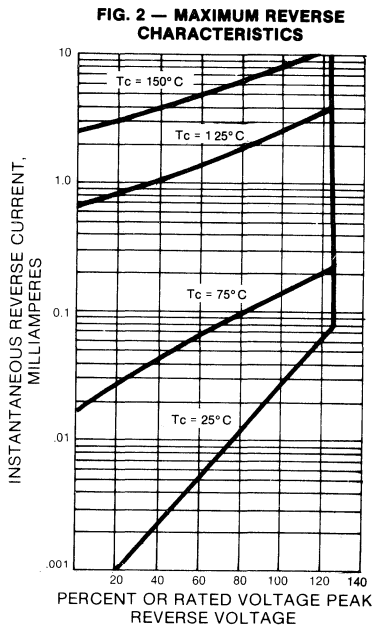
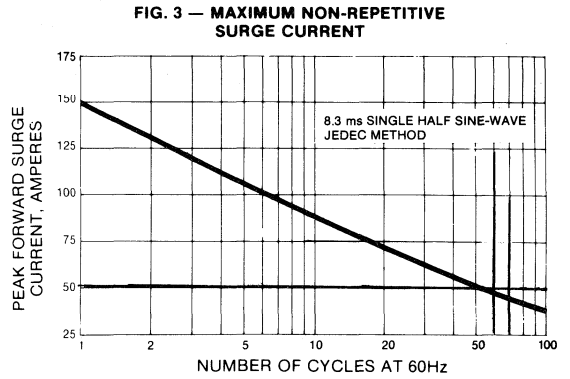
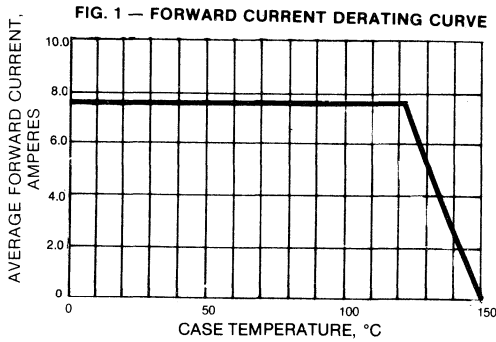

MBRF1035 AND MBRF1045

SCHOTTKY RECTIFIER

VOLTAGE RANGE - 35 and 45 Volts CURRENT - 10.0 Amperes

FEATURES

- ◆ Isolated overmolded package
- ◆ Metal to silicon rectifier majority carrier conduction
- ◆ Low power loss, high efficiency
- ◆ High current capability, low V_f
- ◆ High surge capacity
- ◆ Guard ring for transient protection
- ◆ Epitaxial construction
- ◆ For use in low voltage, high frequency inverters, free wheeling, and polarity protection applications
- ◆ Internal Insulation: 1.5K VRMS

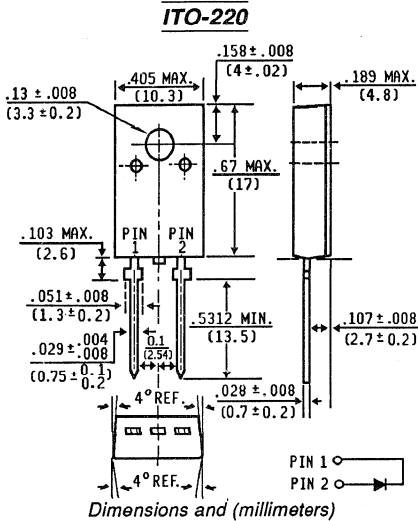
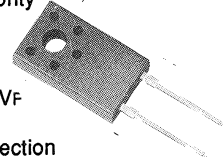

MECHANICAL DATA

Case: ITO-220 full overmolded plastic

Terminals: Leads, solderable per MIL-STD- 202, Method 208

Polarity: As marked

Mounting Position: Any

Mounting Torque: 5in.- lb.max.

Weight: .08 ounces, 2.24 grams

MAXIMUM RATINGS AND ELECTRICAL CHARACTERISTICS

Ratings at 25°C ambient temperature unless otherwise specified. Resistive or inductive load. For capacitive load, derate current by 20%.

	SYMBOLS	MBRF1035	MBRF1045	UNITS
Maximum Recurrent Peak Reverse Voltage	V_{RRM}	35	45	Volts
Working Peak Reverse Voltage	V_{RMS}	25	32	Volts
DC Blocking Voltage	V_{DC}	35	45	Volts
Maximum Average Forward Rectified Current see Fig. 1	$I_{(AV)}$	10		Amps
Peak Repetitive Forward Current , (Square Wave 20 KHz) at $T_c = 135^\circ\text{C}$	I_{FSM}	20		Amps
Peak Forward Surge Current 8.3ms single half sine-wave superimposed on rated load (JEDEC Method)	I_{FSM}	150		Amps
Peak Repetitive Reverse Surge Current (2.0us, 1KHz)	I_{RSM}	1.0		Amps
Voltage Rate of Change, dv/dt (rated V_R)	dv/dt	1000		V/ μ s
Maximum Forward Voltage (Note 1) $I_F = 10A, T_c = 125^\circ\text{C}$ $I_F = 20A, T_c = 125^\circ\text{C}$ $I_F = 20A, T_c = 25^\circ\text{C}$	V_F	0.57 0.72 0.84		Volts
Maximum Instantaneous Reverse Current at Peak Reverse Voltage $T_c = 125^\circ\text{C}$ (Note 1)	I_R	15		mA
Maximum Instantaneous Reverse Current at Peak Reverse Voltage $T_c = 25^\circ\text{C}$	I_R	0.1		mA
Maximum Thermal Resistance, Junction to Case	$R_{\theta JC}$	2.2		$^\circ\text{C}/\text{W}$
Maximum Operating Junction Temperature	T_c	-65 to +150		$^\circ\text{C}$
Maximum Storage Temperature	T_{STG}	-65 to +175		$^\circ\text{C}$

NOTES: 1. Pulse Test Pulse Width 300 μ s, Duty Cycle 2%.

2. 2.0us, 1.0KHz.

RATINGS AND CHARACTERISTIC CURVES MBRF1035 AND MBRF1045

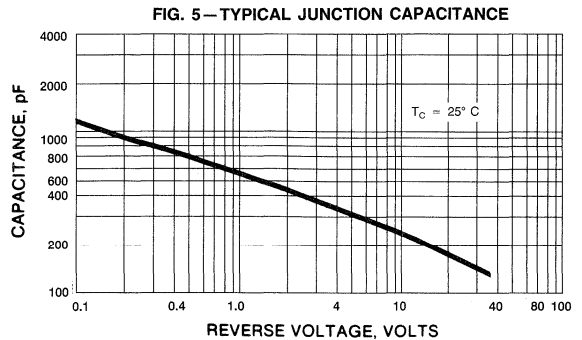
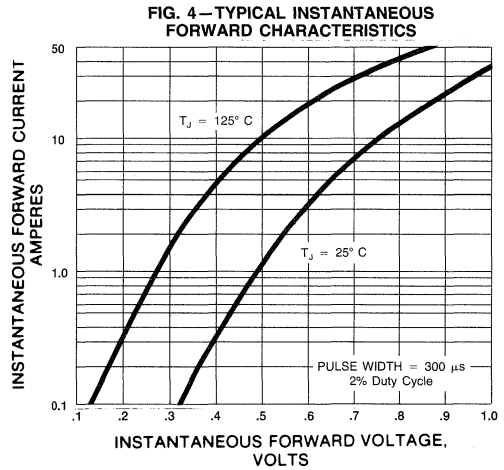
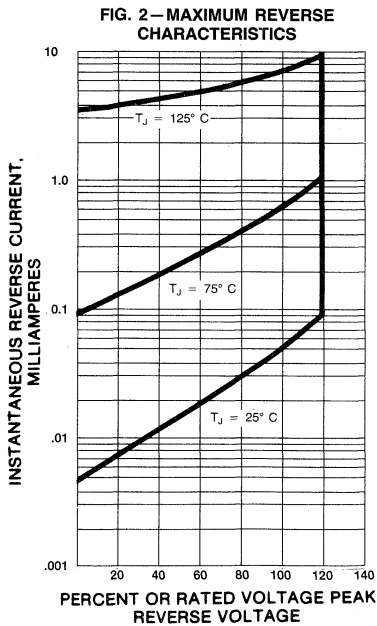
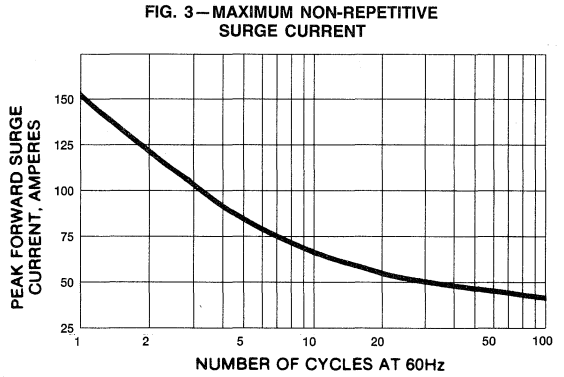
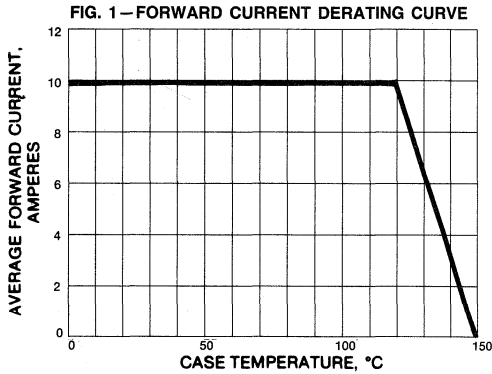

MBRF1050 AND MBRF1060

SCHOTTKY RECTIFIER

VOLTAGE RANGE -50 and 60 Volts CURRENT -10.0 Amperes

FEATURES

- ◆ Isolated plastic package has Underwriters Laboratory Flammability Classifications 94V-0
- ◆ Metal to silicon rectifier, majority carrier conduction
- ◆ Low power loss, high efficiency
- ◆ High current capability, low VF
- ◆ High surge capacity
- ◆ Epitaxial construction
- ◆ Guard Ring for transient protection
- ◆ For use in low voltage, high frequency inverters, free wheeling, and polarity protection applications
- ◆ Internal Insulation: 1.5K VRMS

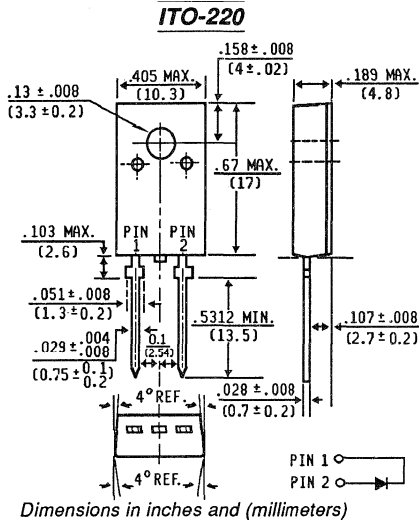
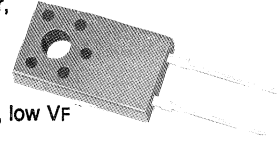

MECHANICAL DATA

Case: ITO-220 Fully over molded Plastic
Terminals: Solderable per MIL-STD-202, Method 208

Polarity: As marked

Mounting Position: Any

Mounting Torque: 5 in.-lb. max.

Weight: .08 ounces, 2.24 grams

MAXIMUM RATINGS AND ELECTRICAL CHARACTERISTICS

Ratings at 25°C ambient temperature unless otherwise specified.

Resistive or inductive load.

For capacitive load, derate current by 20%

	SYMBOLS	MBRF1050	MBRF1060	UNITS
Maximum Recurrent Peak Reverse Voltage	V _{RRM}	50	60	Volts
Working Peak Reverse Voltage	V _{RMS}	35	42	Volts
DC Blocking Voltage	V _{DC}	50	60	Volts
Maximum Average Forward Rectified Current	I _(AV)	10		Amps
Peak Repetitive Forward Current, (Square Wave 20 KHz) at T _C = 135°C	I _{FSM}	20		Amps
Peak Forward Surge Current 8.3ms single half sine-wave superimposed on rated load (JEDEC Method)	I _{FSM}	150		Amps
Peak Repetitive Reverse Surge Current (2.0us, 1KHz)	I _{RSM}	1.0		Amps
Voltage Rate of Change, dv/dt (rated V _R)	V/μs	1000		V/μs
Maximum Forward Voltage (Note 1)	V _F			Volts
		I _F = 10A, T _C = 125°C	0.70	
		I _F = 20A, T _C = 125°C	0.85	
		I _F = 20A, T _C = 25°C	0.95	
Maximum Instantaneous Reverse Current at Peak Reverse Voltage T _C = 125°C (Note 1)	I _R	25		mA
Maximum Instantaneous Reverse Current at Peak Reverse Voltage T _C = 25°C	I _R	0.1		mA
Maximum Thermal Resistance, Junction to Case	R _{θJC}	2.2		°C/W
Maximum Operating Junction Temperature	T _C	-65 to +150		°C
Maximum Storage Temperature	T _{STG}	-65 to +175		°C

NOTES:

1. Pulse Test Pulse Width 300 μs, Duty Cycle 2%.

RATINGS AND CHARACTERISTIC CURVES MBRF1050 AND MBRF1060

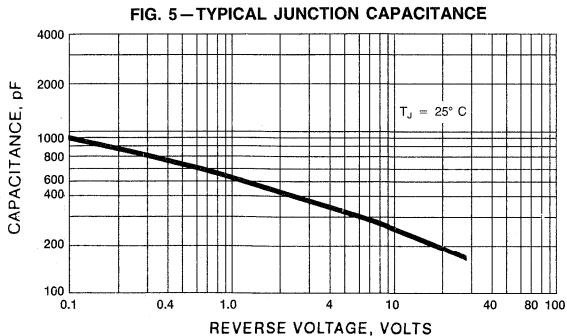
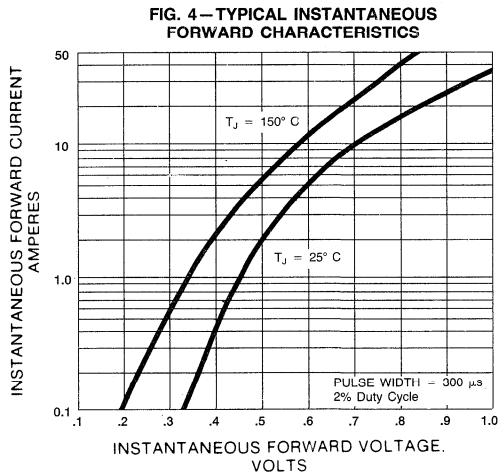
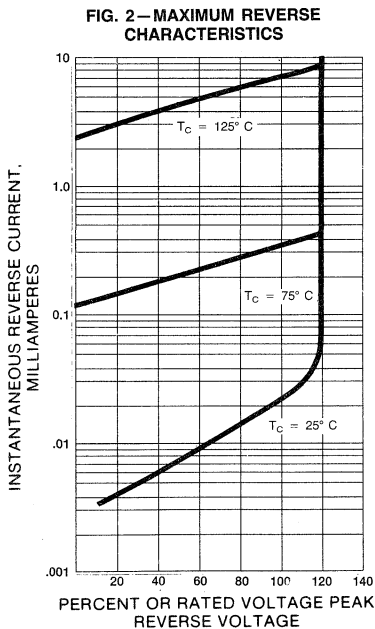
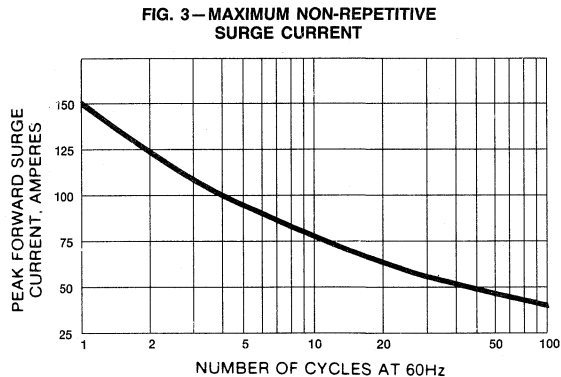
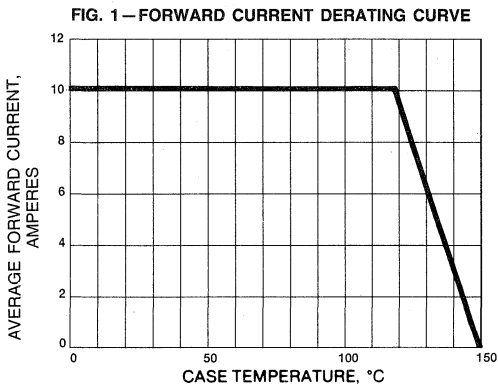

MBRF1090 AND MBRF10100

SCHOTTKY RECTIFIER

VOLTAGE RANGE - 90 and 100 Volts **CURRENT -10.0 Amperes**

FEATURES

- ◆ Isolated plastic package has Underwriters Laboratory Flammability Classifications 94V-O
- ◆ Metal to silicon rectifier, majority carrier conduction
- ◆ Low power loss, high efficiency
- ◆ High current capability, low VF
- ◆ High surge capacity
- ◆ Epitaxial construction
- ◆ For use in low voltage, high frequency inverters, free wheeling, and polarity protection applications
- ◆ Guard Ring for transient protection
- ◆ Internal Insulation: 1.5k VRMS

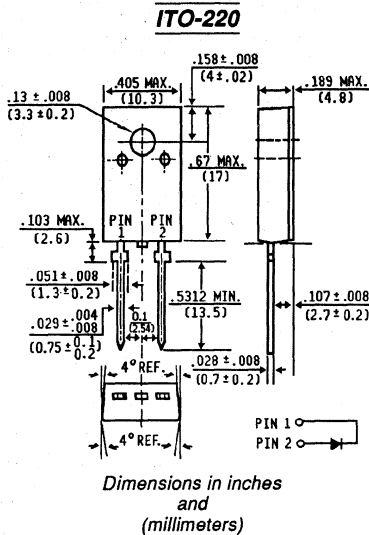
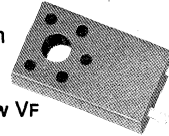

MECHANICAL DATA

Case: ITO-220 Molded Plastic

Terminals: Axial leads, solderable per MIL-STD-202, Method 208

Polarity: As marked

Mounting Position: Any

Mounting Torque: .08 ounces, 2.24 grams

Weight: .08 ounces, 2.24 grams

MAXIMUM RATINGS AND ELECTRICAL CHARACTERISTICS

Ratings at 25°C ambient temperature unless otherwise specified. Resistive or inductive load. For capacitive or inductive load, derate current by 20%.

	SYMBOLS	MBRF1090	MBRF10100	UNITS
Maximum Recurrent Peak Reverse Voltage	VRRM	90	100	Volts
Working Peak Reverse Voltage	VRMS	64	71	Volts
DC Blocking Voltage	VDC	90	100	Volts
Maximum Average Forward Rectified Current see Fig. 1	I(AV)	10		Amps
Peak Repetitive Forward Current , (Square Wave 20 KHz) at T _C = 125°C	I _{FSM}	20		Amps
Peak Forward Surge Current 8.3ms single half sine-wave superimposed on rated load (JEDEC Method)	I _{FSM}	150		Amps
Peak Repetitive Reverse Current (2.0us, 1KHz)	I _{RSM}	1.0		Amps
Voltage Rate of Change, dv/dt (rated V _R)	V/μs	1000		V/μs
Maximum Forward Voltage (Note 1) I _F = 10A, T _C = 25°C I _F = 10A, T _C = 125°C I _F = 20A, T _C = 125°C I _F = 20A, T _C = 25°C	V _F	0.80 0.70 0.85 0.95		Volts
Maximum Instantaneous Reverse Current at Peak Reverse Voltage T _C = 125°C (Note 1)	I _R	25		mA
Peak Reverse Voltage T _C = 25°C	I _R	0.1		mA
Maximum Thermal Resistance, Junction to Case	RθJC	2.0		°C/W
Maximum Operating Junction Temperature	T _C	-65 to +150		°C
Maximum Storage Temperature	T _{STG}	-65 to +175		°C

NOTES: 1. Pulse Test Pulse Width 300 μs, Duty Cycle 2%.

RATINGS AND CHARACTERISTIC CURVES MBRF1090 AND MBRF10100

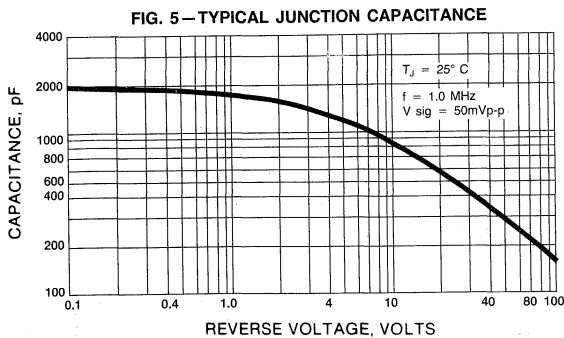
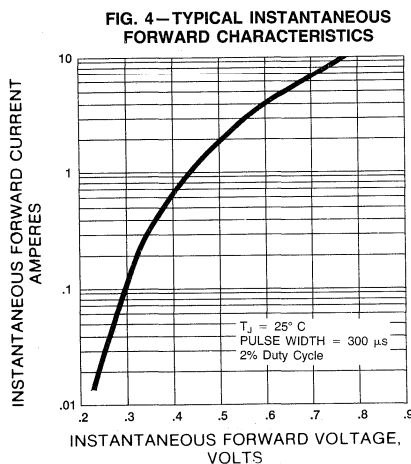
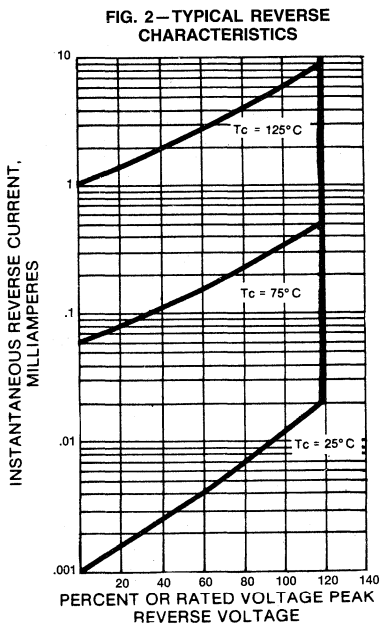
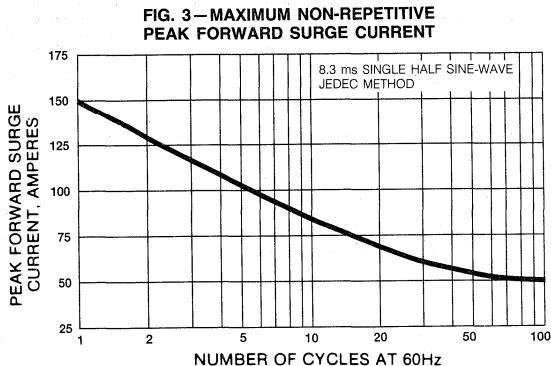
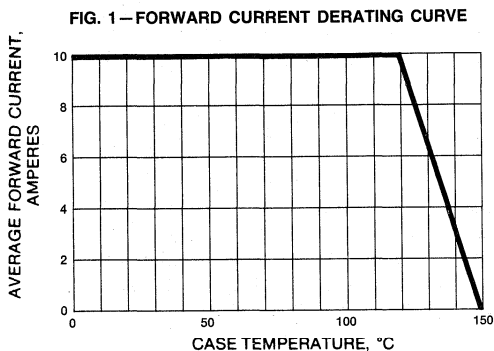

**GENERAL
INSTRUMENT**

MBR1035 AND MBR1045

SCHOTTKY RECTIFIER

VOLTAGE RANGE - 35 and 45 Volts CURRENT - 10.0 Amperes

FEATURES

- ◆ Plastic package has Underwriters Laboratory Flammability Classifications 94V-0
- ◆ Metal to silicon rectifier, majority carrier conduction
- ◆ Low power loss, high efficiency
- ◆ High current capability, low VF
- ◆ High surge capacity
- ◆ Epitaxial construction
- ◆ For use in low voltage, high frequency inverters, free wheeling, and polarity protection applications
- ◆ Guard Ring for transient protection

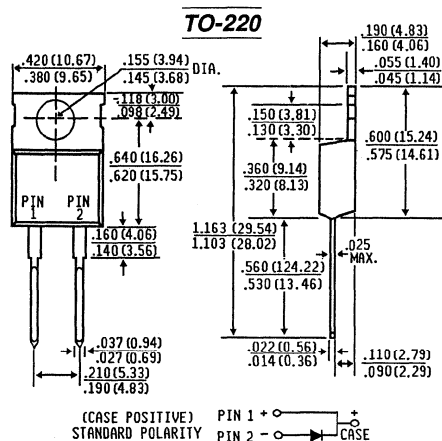
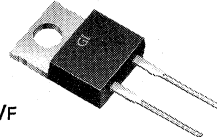

Dimensions and (millimeters)

MECHANICAL DATA

Case: TO-220 Molded Plastic

Terminals: Axial leads, solderable per MIL-STD- 202, Method 208

Polarity: As marked

Mounting Position: Any

Weight: .08 ounces, 2.24 gram

MAXIMUM RATINGS AND ELECTRICAL CHARACTERISTICS

Ratings at 25°C ambient temperature unless otherwise specified. Resistive or inductive load. For capacitive load, derate current by 20%.

	SYMBOLS	MBR1035	MBR1045	UNITS
Maximum Recurrent Peak Reverse Voltage	V_{RRM}	35	45	Volts
Working Peak Reverse Voltage	V_{RWM}	35	45	Volts
DC Blocking Voltage	V_{DC}	35	45	Volts
Maximum Average Forward Rectified Current see Fig. 1	$I_{(AV)}$	10		Amps
Peak Repetitive Forward Current, (Square Wave 20 KHz) at $T_C = 135^\circ\text{C}$	I_{FSM}	20		Amps
Peak Forward Surge Current 8.3ms single half sine-wave superimposed on rated load (JEDEC Method)	I_{FSM}	150		Amps
Peak Repetitive Reverse Surge Current (2.0us, 1KHz)	I_{RSM}	1.0		Amps
Voltage Rate of Change, dv/dt (rated V_R)	dv/dt	1000		V/ μ s
Maximum Forward Voltage (Note 1)	V_F	0.57 0.72 0.84		Volts
		$I_F = 10A, T_C = 125^\circ\text{C}$		
		$I_F = 20A, T_C = 125^\circ\text{C}$		
		$I_F = 20A, T_C = 25^\circ\text{C}$		
Maximum Instantaneous Reverse Current at Peak Reverse Voltage $T_C = 125^\circ\text{C}$ (Note 1)	I_R	15		mA
Maximum Instantaneous Reverse Current at Peak Reverse Voltage $T_C = 25^\circ\text{C}$	I_R	0.1		mA
Maximum Thermal Resistance, Junction to Case	$R_{\theta JC}$	2.0		$^\circ\text{C/W}$
Maximum Operating Junction Temperature	T_C	-65 to +150		$^\circ\text{C}$
Maximum Storage Temperature	T_{STG}	-65 to +175		$^\circ\text{C}$

NOTES: 1. Pulse Test Pulse Width 300 μ s, Duty Cycle 2%.

RATINGS AND CHARACTERISTIC CURVES MBR1035 AND MBR1045

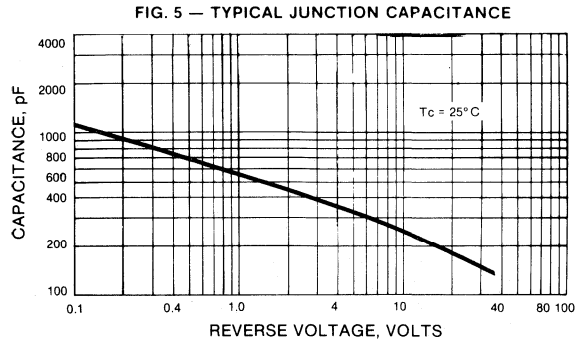
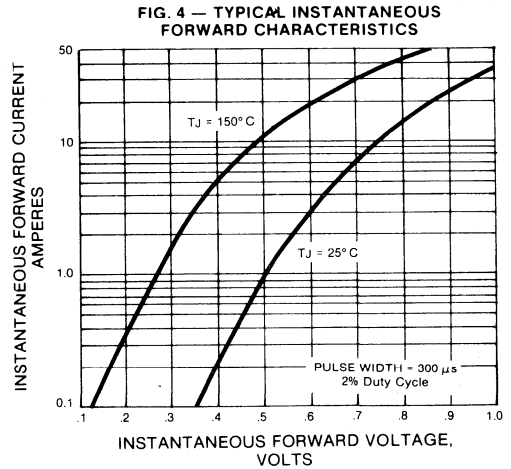
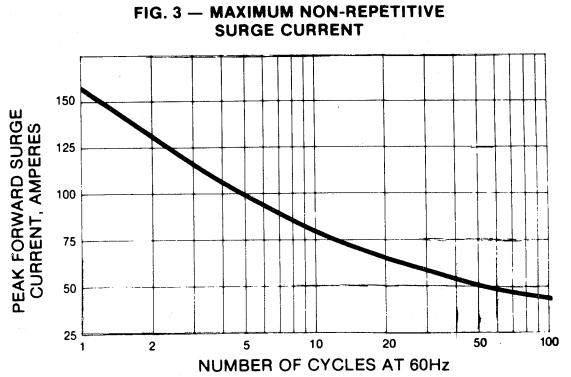
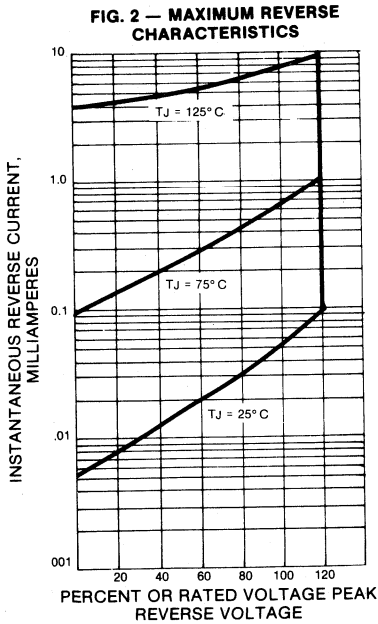
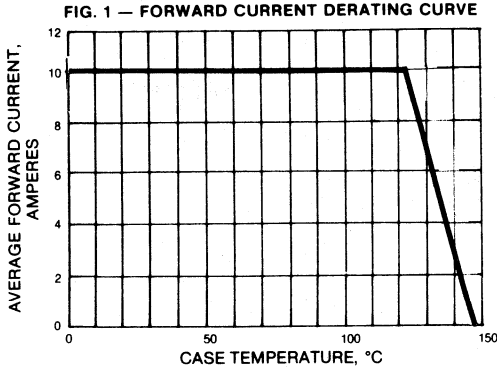

MBR1050 AND MBR1060

SCHOTTKY RECTIFIER

VOLTAGE RANGE -50 and 60 Volts CURRENT -10.0 Amperes

FEATURES

- ◆ Plastic package has Underwriters Laboratory Flammability Classifications 94V-0.
- ◆ Metal to silicon rectifier, majority carrier conduction
- ◆ Low power loss, high efficiency
- ◆ High current capability, low VF
- ◆ High surge capacity
- ◆ Epitaxial construction
- ◆ For use in low voltage, high frequency inverters, free wheeling, and polarity protection applications
- ◆ Guard Ring for transient protection

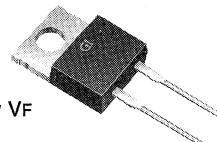

TO-220

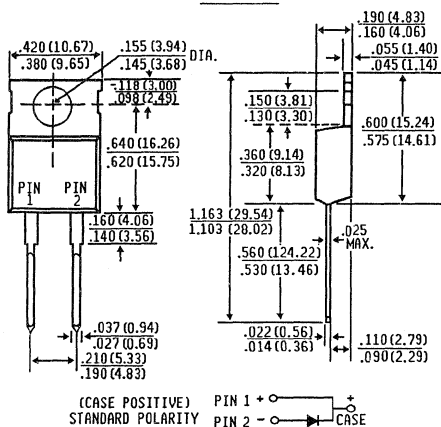

Dimensions in inches and (millimeters)

MECHANICAL DATA

Case: TO-220 Molded Plastic

Terminals: Solderable per MIL-STD-202, Method 208

Polarity: As marked

Mounting Position: Any

Weight: .08 ounces, 2.24 gram

MAXIMUM RATINGS AND ELECTRICAL CHARACTERISTICS

Ratings at 25°C ambient temperature unless otherwise specified. Resistive or inductive load. For capacitive load, derate current by 20%.

	CYMBOLS	MBR1050	MBR1060	UNITS
Maximum Recurrent Peak Reverse Voltage	V _{RRM}	50	60	Volts
Working Peak Reverse Voltage	V _{RWM}	50	60	Volts
DC Blocking Voltage	V _{DC}	50	60	Volts
Maximum Average Forward Rectified Current see Fig. 1	I _(AV)	10		Amps
Peak Repetitive Forward Current, (Square Wave 20 KHz) at T _C = 135°C	I _{FSM}	20		Amps
Peak Forward Surge Current 8.3ms single half sine-wave superimposed on rated load (JEDEC Method)	I _{FSM}	150		Amps
Peak Repetitive Reverse Surge Current (2.0us, 1KHz)	I _{RSM}	1.0		Amps
Voltage Rate of Change, dv/dt (rated V _R)	V/μs	1000		V/μs
Maximum Forward Voltage (Note 1)	V _F	0.70 0.85 0.95		Volts
Maximum Instantaneous Reverse Current at Peak Reverse Voltage T _C = 125°C (Note 1)	I _R	25		mA
Maximum Instantaneous Reverse Current at Peak Reverse Voltage T _C = 25°C	I _R	0.1		mA
Maximum Thermal Resistance, Junction to Case	R _{θJC}	2.0		°C/W
Maximum Operating Junction Temperature	T _C	-65 to +150		°C
Maximum Storage Temperature	T _{STG}	-65 to +175		°C

NOTES: 1. Pulse Test Pulse Width 300 μs, Duty Cycle 2%.

RATINGS AND CHARACTERISTIC CURVES MBR1050 AND MBR1060

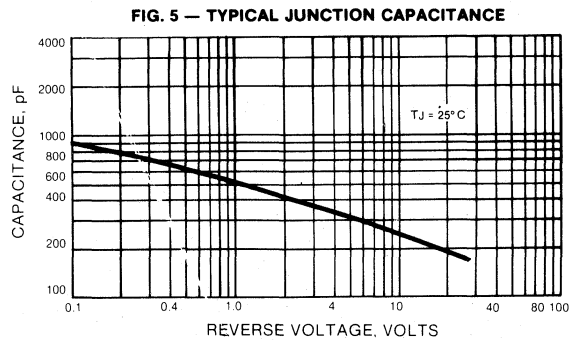
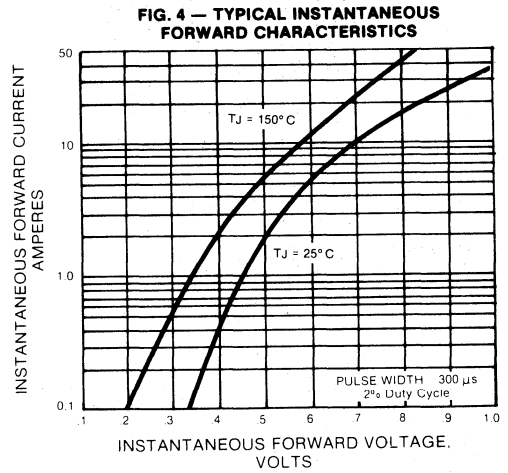
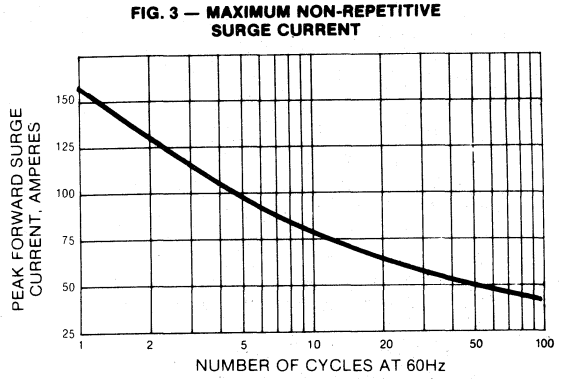
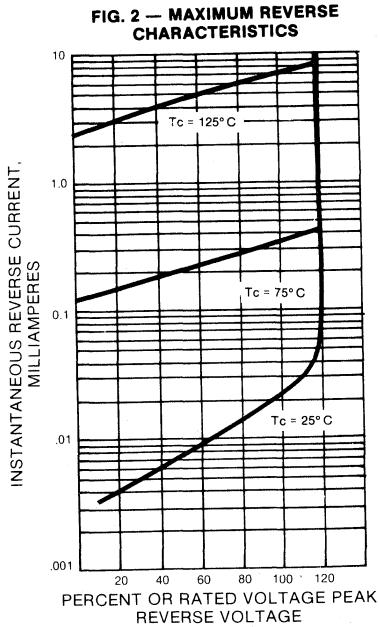
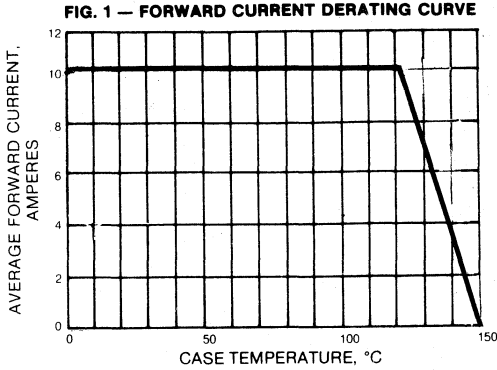

MBR1090 AND MBR10100

SCHOTTKY RECTIFIER

VOLTAGE RANGE - 90 and 100 Volts CURRENT -10.0 Amperes

FEATURES

- ◆ Plastic package has Underwriters Laboratory Flammability Classifications 94V-O.
- ◆ Metal to silicon rectifier, majority carrier conduction
- ◆ Low power loss, high efficiency
- ◆ High current capability, low V_f
- ◆ High surge capacity
- ◆ Epitaxial construction
- ◆ For use in low voltage, high frequency inverters, free wheeling, and polarity protection applications
- ◆ Guard Ring for transient protection

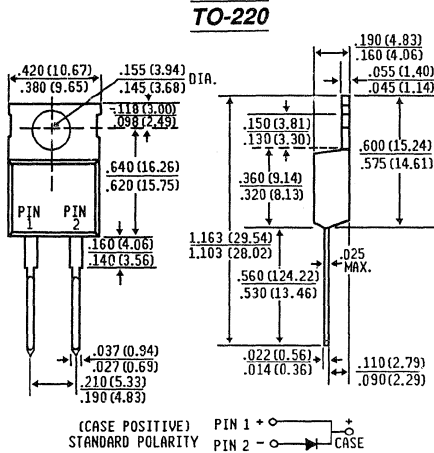
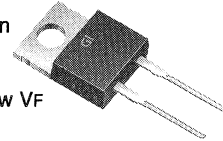

Dimensions in inches and (millimeters)

MECHANICAL DATA

Case: TO-220 Molded Plastic

Terminals: Axial leads, solderable per MIL-STD-202, Method 208

Polarity: As marked

Mounting Position: Any

Weight: .08 ounces, 2.24 gram

MAXIMUM RATINGS AND ELECTRICAL CHARACTERISTICS

Ratings at 25°C ambient temperature unless otherwise specified. Resistive or inductive load. For capacitive load, derate current by 20%.

	SYMBOLS	MBR1090	MBR10100	UNITS
Maximum Recurrent Peak Reverse Voltage	V_{RRM}	90	100	Volts
Working Peak Reverse Voltage	V_{RWM}	90	100	Volts
DC Blocking Voltage	V_{DC}	90	100	Volts
Maximum Average Forward Rectified Current see Fig. 1	$I_{(AV)}$	10		Amps
Peak Repetitive Forward Current, (Square Wave 20 KHz) at $T_C = 125^\circ\text{C}$	I_{FSM}	20		Amps
Peak Forward Surge Current 8.3ms single half sine-wave superimposed on rated load (JEDEC Method)	I_{FSM}	150		Amps
Peak Repetitive Reverse Surge Current (2.0us, 1KHz)	I_{RSM}	1.0		Amps
Voltage Rate of Change, dv/dt (rated V_R)	$V/\mu\text{s}$	1000		$V/\mu\text{s}$
Maximum Forward Voltage (Note 1) $I_F = 10\text{A}, T_C = 25^\circ\text{C}$ $I_F = 10\text{A}, T_C = 125^\circ\text{C}$ $I_F = 20\text{A}, T_C = 125^\circ\text{C}$ $I_F = 20\text{A}, T_C = 25^\circ\text{C}$	V_F	0.80 0.70 0.85 0.95		Volts
Maximum Instantaneous Reverse Current at Peak Reverse Voltage $T_C = 125^\circ\text{C}$ (Note 1)	I_R	25		mA
Peak Reverse Voltage $T_C = 25^\circ\text{C}$	I_R	0.1		mA
Maximum Thermal Resistance, Junction to Case	$R_{\theta JC}$	2.0		$^\circ\text{C/W}$
Maximum Operating Junction Temperature	T_C	-65 to +150		$^\circ\text{C}$
Maximum Storage Temperature	T_{STG}	-65 to +175		$^\circ\text{C}$

NOTES: 1. Pulse Test Pulse Width 300 μs , Duty Cycle 2%.

RATINGS AND CHARACTERISTIC CURVES MBR1090 AND MBR10100

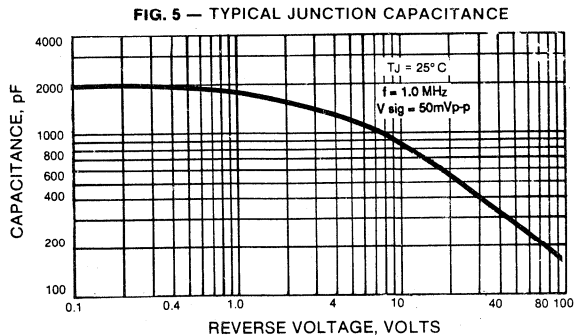
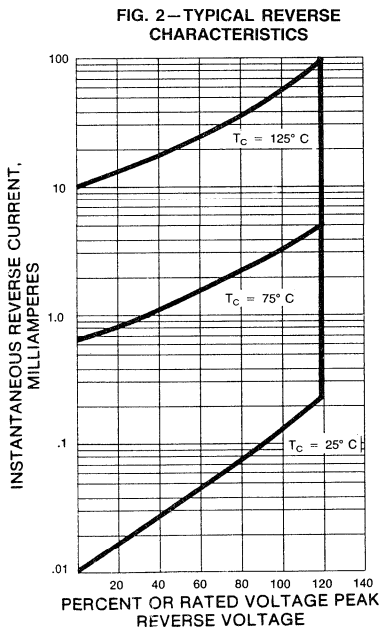
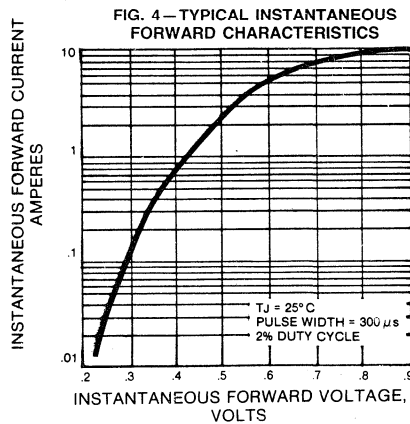
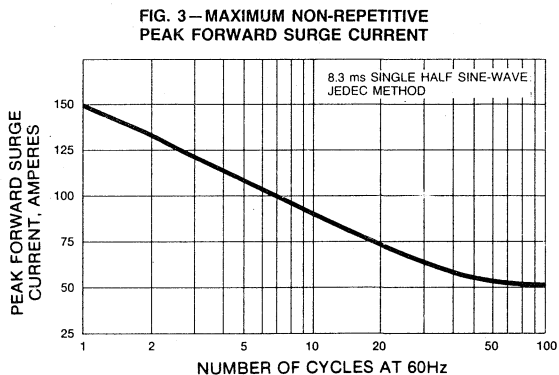
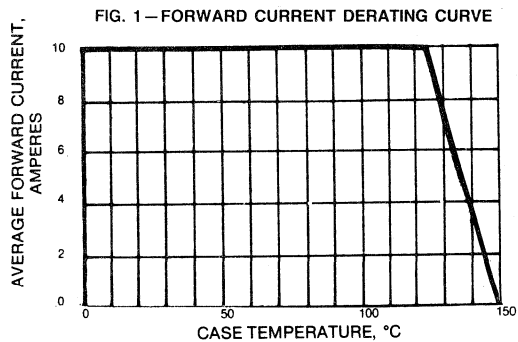

SBLF1030 AND SBLF1040

SCHOTTKY RECTIFIER

VOLTAGE RANGE - 30 and 40 Volts CURRENT - 10 Amperes

FEATURES

- ◆ Isolated overmolded package
- ◆ Metal to silicon rectifier, majority carrier conduction
- ◆ Low power loss, high efficiency
- ◆ High current capability, low VF
- ◆ High surge capacity
- ◆ Epitaxial construction
- ◆ Guard Ring for transient protection
- ◆ For use in low voltage, high frequency inverters, free wheeling, and polarity protection applications
- ◆ High temperature soldering guaranteed: 250°C/10 seconds/.25", (6.35mm) from case
- ◆ Internal Insulation: 1.5k VRMS

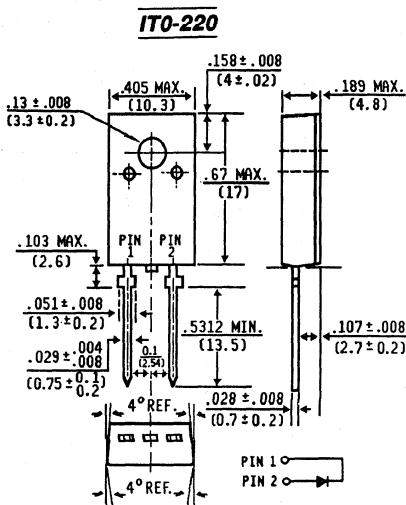
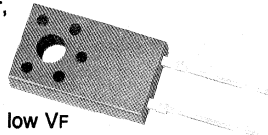

Dimensions in inches
and
millimeters

MECHANICAL DATA

Case: ITO-220 fully overmolded Plastic

Terminals: leads, solderable per MIL-STD- 202, Method 208

Polarity: As marked

Mounting Position: Any

Mounting Torque: 5 in. - lb. max.

Weight: .08 ounces, 2.24 grams

MAXIMUM RATINGS AND ELECTRICAL CHARACTERISTICS

Ratings at °C ambient temperature unless otherwise specified.

Resistive or inductive load. For capacitive or inductive load, derate current by 20%.

	SYMBOLS	SBLF1030	SBLF1040	UNITS
Maximum Recurrent Peak Reverse Voltage	V _{RRM}	30	40	Volts
Maximum RMS Voltage	V _{RMS}	21	28	Volts
Maximum DC Blocking Voltage	V _{DC}	30	40	Volts
Maximum Average Forward Rectified Current See Fig. 1	I _(AV)	10		Amps
Peak Forward Surge Current, 8.3ms single half sine-wave superimposed on rated load (JEDEC Method)	I _{FSM}	250		Amps
Maximum Instantaneous Forward Voltage I _F = 10A, T _c = 25°C (Note 2)	V _F	.60		Volts
Maximum Average Reverse Current at T _c = 25°C	I _R	1.0		mA
Rated DC Blocking Voltage per element T _c = 100°C	I _R	50.0		mA
Typical Thermal Resistance (Note 1)	R _{θJC}	3.5		°C/W
Operating and Storage Temperature Range	T _c , T _{STG}	-40 to +125		°C

NOTES:

1. Thermal Resistance from Junction to Case.
2. 300 μs Pulse Width, 2% Duty Factor.

RATINGS AND CHARACTERISTIC CURVES SBLF1030 AND SBLF1040

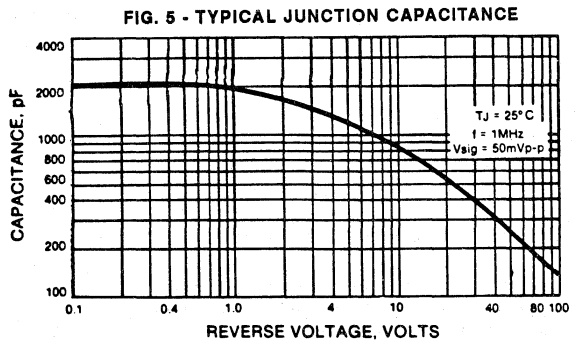
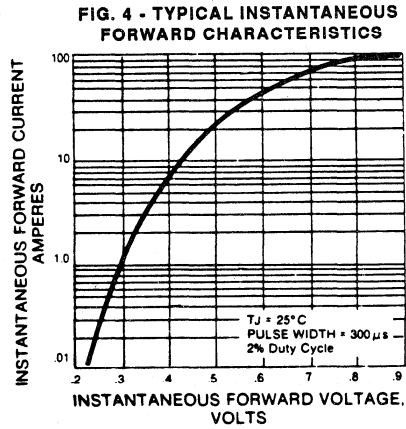
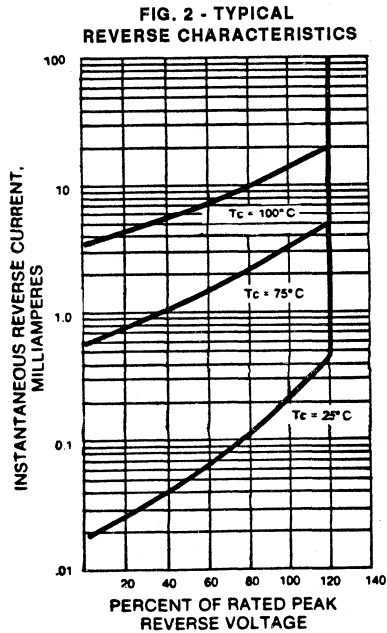
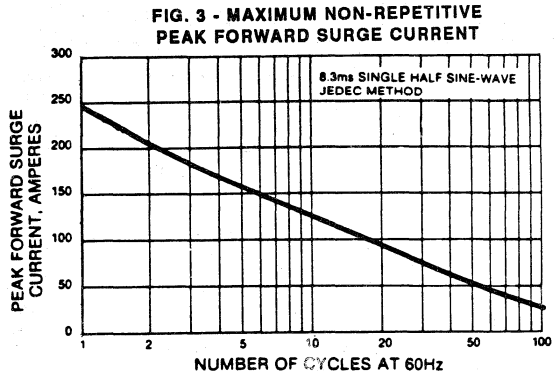
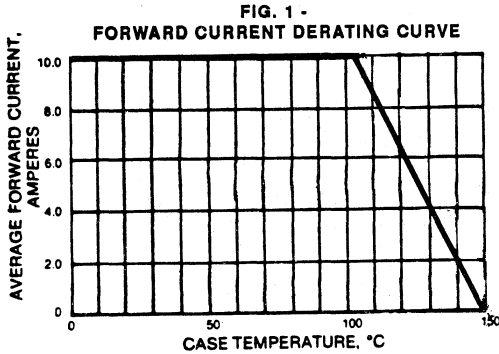

SBL1030 AND SBL1040

SCHOTTKY RECTIFIER

VOLTAGE RANGE - 30 and 40 Volts CURRENT - 10 Amperes

FEATURES

- ◆ Plastic package has Underwriters Laboratory Flammability Classifications 94V-O.
- ◆ Metal to silicon rectifier, majority carrier conduction
- ◆ Low power loss, high efficiency
- ◆ High current capability, low VF
- ◆ High surge capacity
- ◆ Epitaxial construction
- ◆ For use in low voltage, high frequency inverters, free wheeling, and polarity protection applications
- ◆ High temperature soldering guaranteed: 250°C/10 seconds/.25", (6.35mm) from case
- ◆ Guard Ring for transient protection

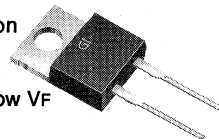

TO-220

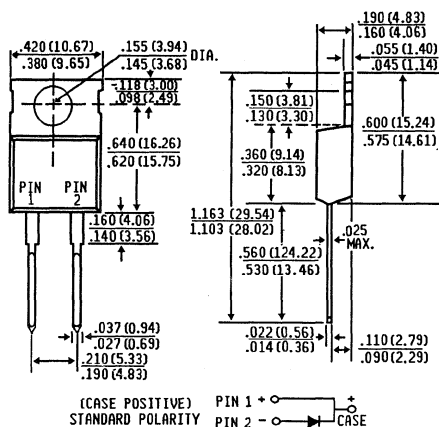

Dimensions in inches
and
(millimeters)

MECHANICAL DATA

Case: TO-220 Molded Plastic

Terminals: Solderable per MIL-STD- 202, Method 208

Polarity: As marked

Mounting Position: Any

Weight: .08 ounces, 2.24 gram

CROSS REFERENCE GUIDE

GI	FUJI	SHINDENEN
SBL1040	ERC62-004	---

MAXIMUM RATINGS AND ELECTRICAL CHARACTERISTICS

Ratings at 25 °C ambient temperature unless otherwise specified. Resistive or inductive load.
For capacitive or inductive load, derate current by 20%.

	SYMBOLS	SBL1030	SBL1040	UNITS
Maximum Recurrent Peak Reverse Voltage	V _{RRM}	30	40	Volts
Maximum RMS Voltage	V _{RMS}	21	28	Volts
Maximum DC Blocking Voltage	V _{DC}	30	40	Volts
Maximum Average Forward Rectified Current see Fig. 1	I _(AV)	10		Amps
Peak Forward Surge Current, 8.3ms single half sine-wave superimposed on rated load (JEDEC Method)	I _{FSM}	250		Amps
Maximum Instantaneous Forward Voltage I _F = 10A, T _C = 25°C (Note 2)	V _F	.60		Volts
Maximum Average Reverse Current at T _C = 25°C Rated DC Blocking Voltage per element T _C = 100°C	I _R	50.0		mA
Typical Thermal Resistance (Note 1)	R _{ΘJC}	3.0		°C/W
Operating and Storage Temperature Range	T _C , T _{STG}	-40 to +125		°C

NOTES:

1. Thermal Resistance from Junction to Case.
2. 300 μs Pulse Width, 2% Duty Factor.

RATINGS AND CHARACTERISTIC CURVES SBL1030 AND SBL1040

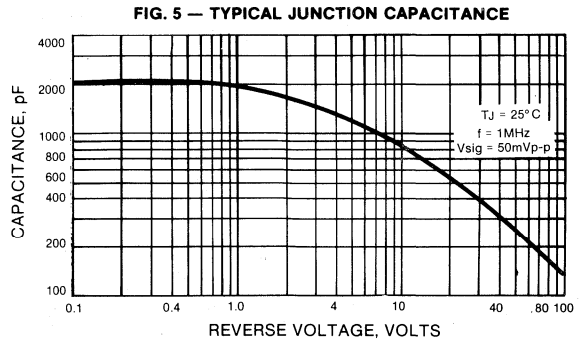
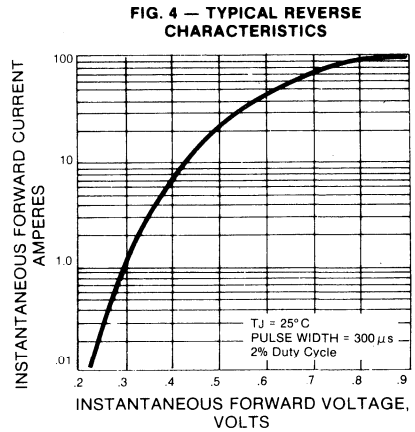
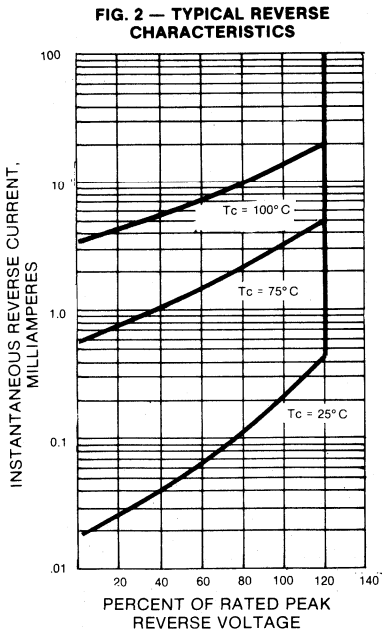
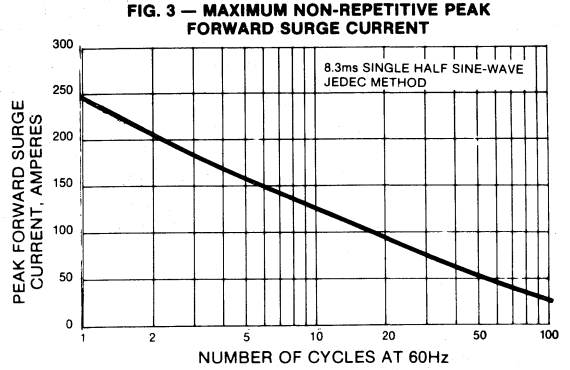
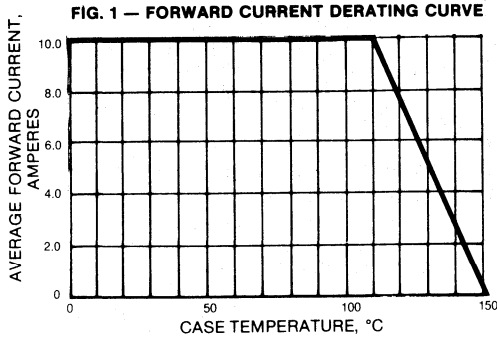

SBLF1030CT AND SBLF1040CT

SCHOTTKY RECTIFIER

VOLTAGE RANGE - 30 and 40 Volts CURRENT - 10 Amperes

FEATURES

- ◆ Isolated Plastic package has Underwriters Laboratory Flammability Classifications 94V-O
- ◆ Metal to silicon rectifier, majority carrier conduction
- ◆ Low power loss, high efficiency
- ◆ High current capability, low VF
- ◆ High surge capacity
- ◆ Epitaxial construction
- ◆ For use in low voltage, high frequency inverters, free wheeling, and polarity protection applications
- ◆ Dual rectifier construction, positive center-tap
- ◆ Guard Ring for transient protection
- ◆ Internal Insulation: 1.5k VRMS

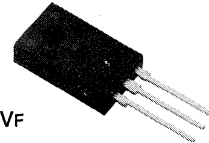

ITO-220 CT

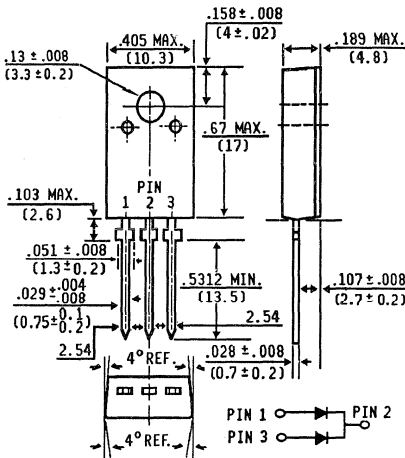

Dimensions in inches
and
(millimeters)

MECHANICAL DATA

Case: ITO-220 Molded Plastic

Terminals: Solderable per MIL-STD-202, Method 208

Polarity: As marked

Mounting Position: Any

Mounting Torque: 5 in. - lb. max.

Weight: .08 ounces, 2.24 grams

MAXIMUM RATINGS AND ELECTRICAL CHARACTERISTICS

Ratings at 25°C ambient temperature unless otherwise specified.
Resistive or inductive load.
For capacitive or inductive load, derate current by 20%.

	SYMBOLS	SBLF1030CT	SBLF1040CT	UNITS
Maximum Recurrent Peak Reverse Voltage	V _{RRM}	30	40	Volts
Maximum RMS Voltage	V _{RMS}	21	28	Volts
Maximum DC Blocking Voltage	V _{DC}	30	40	Volts
Maximum Average Forward Rectified Current See Fig. 1	I _(AV)	10.0		Amps
Peak Forward Surge Current, 8.3ms single half sine-wave superimposed on rated load (JEDEC Method)	I _{FSM}	175		Amps
Maximum Instantaneous Forward Voltage Per Leg I _F = 5.0A, T _C = 25°C (Note 2)	V _F	.55		Volts
Maximum Average Reverse Current at T _C = 25°C Rated DC Blocking Voltage per element T _C = 100°C	I _R	50.0		mA
Typical Thermal Resistance (Note 1)	R _{θJC}	3.5		°C/W
Operating Temperature Range	T _C	-40 to +125		°C
Storage Temperature Range	T _{STG}	-40 to +150		°C

NOTES:

1. Thermal Resistance from Junction to Case per element.
2. 300μs Pulse Width, 2% Duty Factor.

RATINGS AND CHARACTERISTIC CURVES SBLF1030CT AND SBLF1040CT

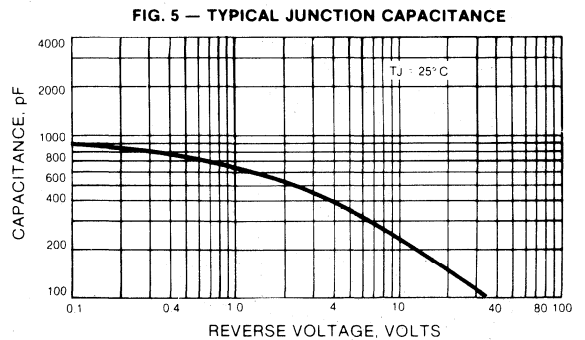
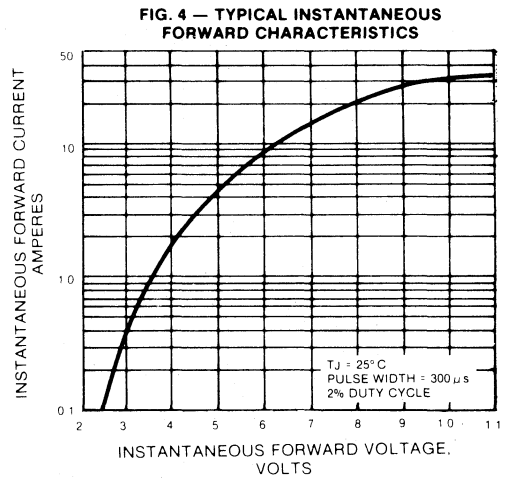
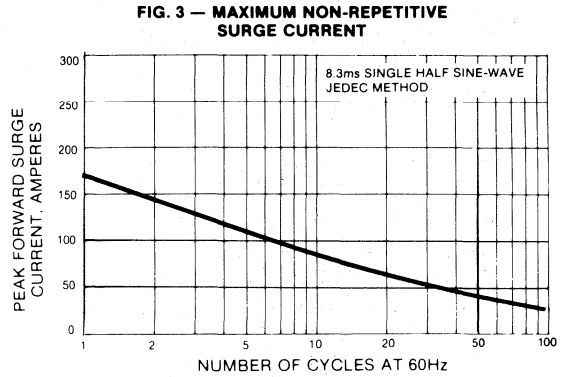
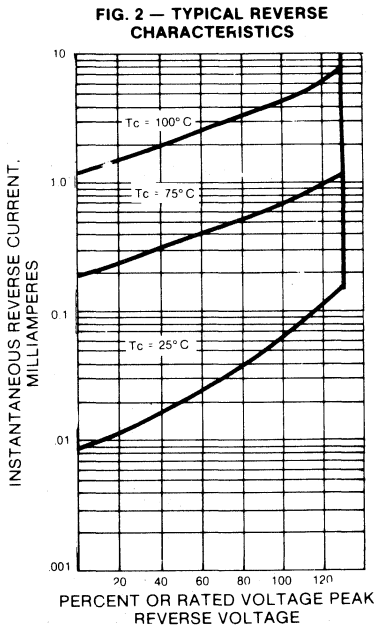
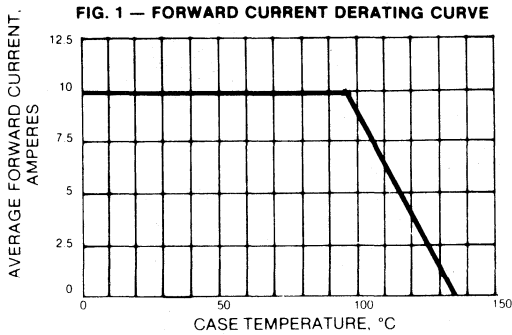

SBL1030CT AND SBL1040CT

SCHOTTKY RECTIFIER

VOLTAGE RANGE - 30 and 40 Volts CURRENT - 10 Amperes

FEATURES

- ◆ Plastic package has Underwriters Laboratory Flammability Classifications 94V-0
- ◆ Metal to silicon rectifier, majority carrier conduction
- ◆ Low power loss, high efficiency
- ◆ High current capability, low VF
- ◆ High surge capacity
- ◆ Epitaxial construction
- ◆ For use in low voltage, high frequency inverters, free wheeling, and polarity protection applications
- ◆ Dual rectifier construction, positive center-tap
- ◆ Guard Ring for transient protection

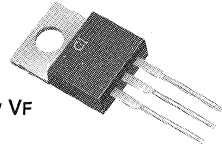

TO-220 CT

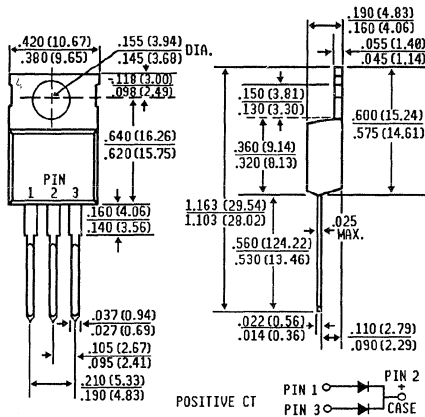

Dimensions in inches
and
(millimeters)

MECHANICAL DATA

Case: TO-220 Molded Plastic

Terminals: Solderable per MIL-STD- 202, Method 208

Polarity: As marked

Mounting Position: Any

Weight: .08 ounces, 2.24 gram

CROSS-REFERENCE GUIDE

GI	FUJI	SHINDENGEN
SBL1040CT	ESAC82-004	- - -

MAXIMUM RATINGS AND ELECTRICAL CHARACTERISTICS

Ratings at 25°C ambient temperature unless otherwise specified.

Resistive or inductive load.

For capacitive or inductive load, derate current by 20%.

	SYMBOLS	SBL1030CT	SBL1040CT	UNITS
Maximum Recurrent Peak Reverse Voltage	V_{RRM}	30	40	Volts
Maximum RMS Voltage	V_{RMS}	21	28	Volts
Maximum DC Blocking Voltage	V_{DC}	30	40	Volts
Maximum Average Forward Rectified Current See Fig. 1	$I_{(AV)}$	10.0		Amps
Peak Forward Surge Current, 8.3ms single half sine-wave superimposed on rated load (JEDEC Method)	I_{FSM}	175		Amps
Maximum Instantaneous Forward Voltage Per Leg $I_F = 5.0A, T_C = 25^\circ C$ (Note 2)	V_F	.55		Volts
Maximum Average Reverse Current at $T_C = 25^\circ C$ Rated DC Blocking Voltage per element $T_C = 100^\circ C$	I_R	50.0		mA
Typical Thermal Resistance (Note 1)	$R_{\theta JC}$	3.0		$^\circ C/W$
Operating Temperature Range	T_C	-40 to +125		$^\circ C$
Storage Temperature Range	T_{STG}	-40 to +150		$^\circ C$

NOTES:

1. Thermal Resistance from Junction to Case.

2. 300μs Pulse Width, 2% Duty Factor.

RATINGS AND CHARACTERISTIC CURVES SBL1030CT AND SBL1040CT

FIG. 1 — FORWARD CURRENT DERATING CURVE

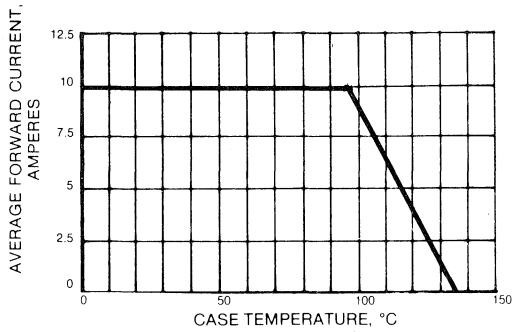

FIG. 2 — TYPICAL REVERSE CHARACTERISTICS

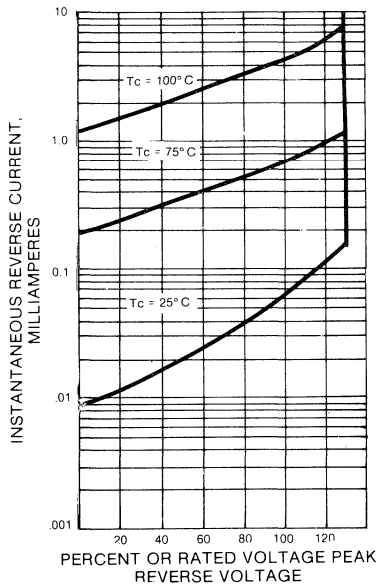

FIG. 3 — MAXIMUM NON-REPETITIVE SURGE CURRENT

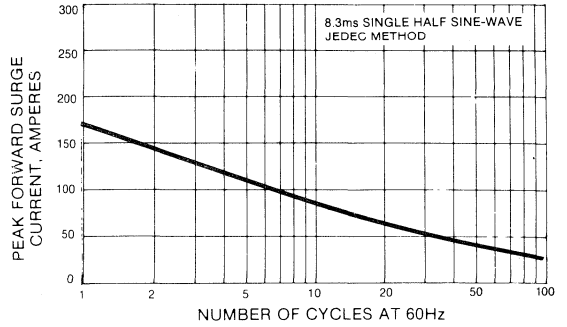

FIG. 4 — TYPICAL INSTANTANEOUS FORWARD CHARACTERISTICS

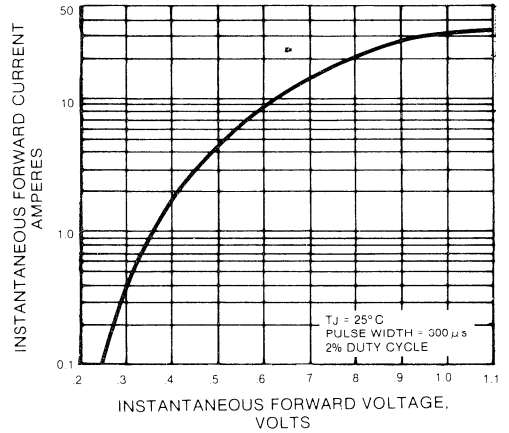
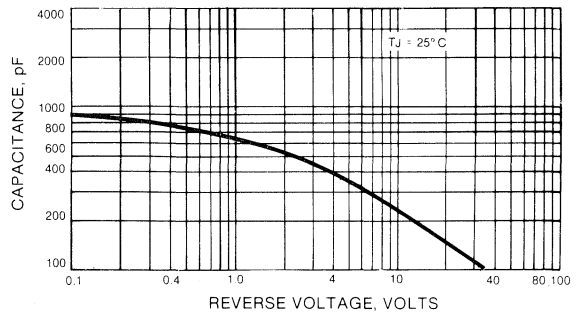

FIG. 5 — TYPICAL JUNCTION CAPACITANCE



MBRF1535CT AND MBRF1545CT

SCHOTTKY RECTIFIER

VOLTAGE RANGE - 35 and 45 Volts CURRENT - 15 Amperes

FEATURES

- ◆ Isolated plastic package has Underwriters Laboratory Flammability Classifications 94V-0
- ◆ Metal to silicon rectifier, majority carrier conduction
- ◆ Low power loss, high efficiency
- ◆ High current capability, low VF
- ◆ High surge capacity
- ◆ Epitaxial construction
- ◆ For use in low voltage, high frequency inverters, free wheeling, and polarity protection applications
- ◆ High temperature soldering guaranteed:
250°C/10 seconds/.25", (6.35mm) from case
- ◆ Guard Ring for transient protection
- ◆ Internal Insulation: 1.5k VRMS

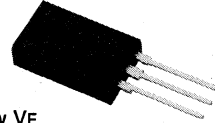

ITO-220 CT

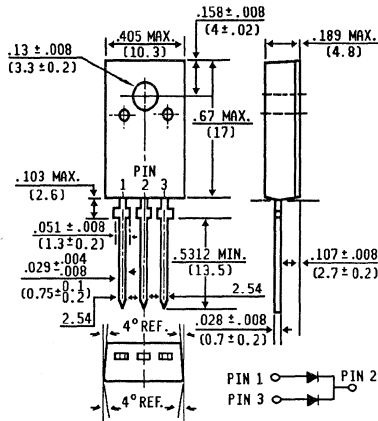

Dimensions in inches
and
(millimeters)

MECHANICAL DATA

Case: ITO-220 Molded Plastic

Terminals: Solderable per MIL-STD-202, Method 208

Polarity: As marked

Mounting Position: Any

Mounting Torque: 5 in. - lb. max.

Weight: .08 ounces, 2.24 grams

MAXIMUM RATINGS AND ELECTRICAL CHARACTERISTICS

Ratings at 25 °C ambient temperature unless otherwise specified.

Resistive or inductive load.

For capacitive or inductive load, derate current by 20%.

	SYMBOLS	MBRF1535CT	MBRF1545CT	UNITS
Maximum Recurrent Peak Reverse Voltage	V_{RRM}	35	45	Volts
Working Peak Reverse Voltage	V_{RWS}	25	32	Volts
DC Blocking Voltage	V_{DC}	35	45	Volts
Maximum Average Forward Rectified Current See Fig. 1	$I_{(AV)}$	15.0		Amps
Peak Forward Surge Current, 8.3ms single half sine-wave superimposed on rated load (JEDEC Method)	I_{FSM}	150		Amps
Maximum Instantaneous Forward Voltage Per Leg $I_F = 7.5A, T_C = 125^\circ C$ (Note 2) $I_F = 15A, T_C = 125^\circ C$ $I_F = 15A, T_C = 25^\circ C$	V_F	.057 0.72 0.84		Volts
Maximum Instantaneous Reverse Current at Rated DC Blocking Voltage per element $T_C = 125^\circ C$	I_R	15.0		mA
Maximum Instantaneous Reverse Current at Rated DC Blocking Voltage per element $T_C = 25^\circ C$	I_R	0.1		mA
Voltage Rate of Change, (Rated V_R)	dv/dt	1000		V/ μs
Typical Thermal Resistance (Note 1)	$R_{\theta JC}$	3.5		$^\circ C/W$
Maximum Operating Junction Temperature	T_C	-65 to +150		$^\circ C$
Maximum Storage Temperature	T_{STG}	-65 to +150		$^\circ C$

NOTES: 1. Thermal Resistance from Junction to Case per element.

2. 300 μs Pulse Width, 2% Duty Factor.

RATINGS AND CHARACTERISTIC CURVES MBRF1535CT AND MBRF1545CT

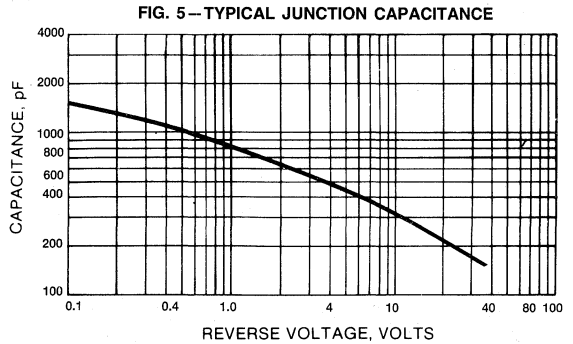
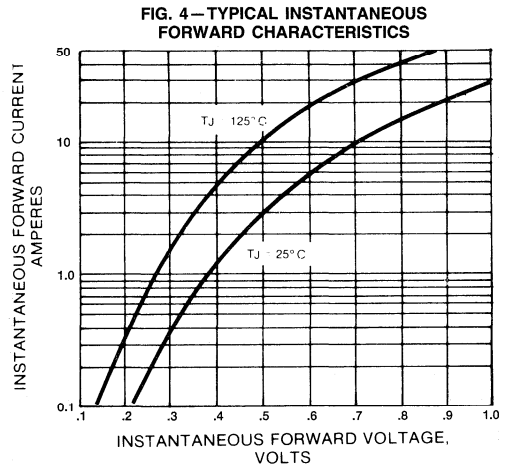
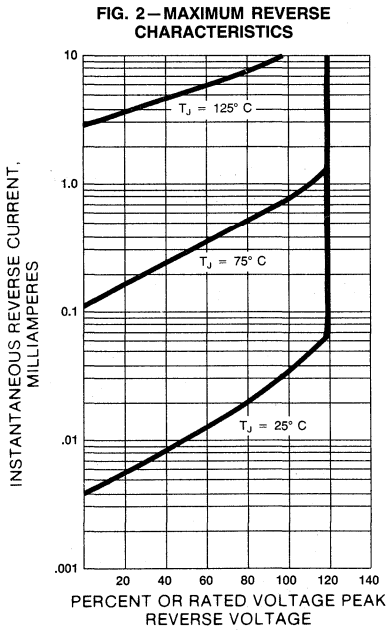
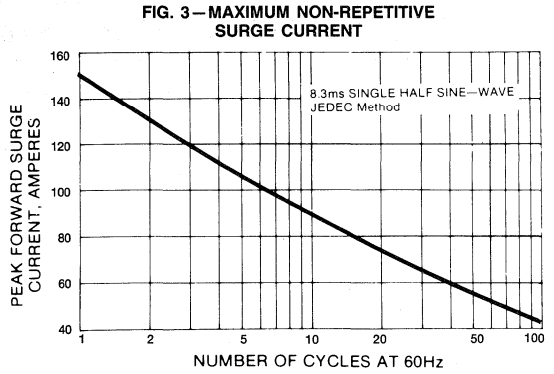
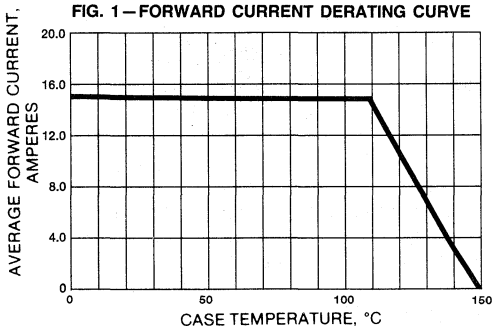

GENERAL INSTRUMENT

MBRF1550CT AND MBRF1560CT

SCHOTTKY RECTIFIER

VOLTAGE RANGE - 50 and 60 Volts CURRENT - 15 Amperes

FEATURES

- ◆ Isolated plastic package has Underwriters Laboratory Flammability Classifications 94V-0
- ◆ Metal to silicon rectifier, majority carrier conduction
- ◆ Low power loss, high efficiency
- ◆ High current capability, low VF
- ◆ High surge capacity
- ◆ Epitaxial construction
- ◆ For use in low voltage, high frequency inverters, free wheeling, and polarity protection applications
- ◆ High temperature soldering guaranteed: 250°C/10 seconds/.25", (6.35mm) from case
- ◆ Guard Ring for transient protection
- ◆ Internal Insulation: 1.5k VRMS

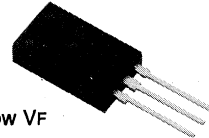

ITO-220 CT

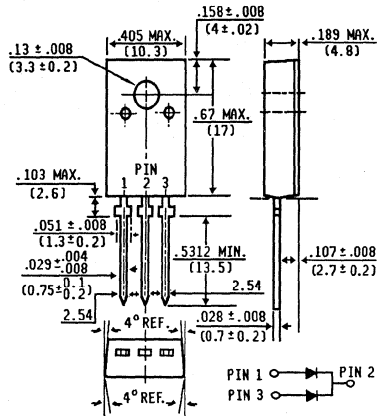

Dimensions in inches
and
(millimeters)

MECHANICAL DATA

- Case:** ITO-220 Molded Plastic
Terminals: Solderable per MIL-STD-202, Method 208
Polarity: As marked
Mounting Position: Any
Mounting Torque: 5 in. - lb. max.
Weight: .08 ounces, 2.24 grams

MAXIMUM RATINGS AND ELECTRICAL CHARACTERISTICS

Ratings at 25 °C ambient temperature unless otherwise specified.
 Resistive or inductive load.
 For capacitive or inductive load, derate current by 20%.

	SYMBOLS	MBRF1550CT	MBRF1560CT	UNITS
Maximum Recurrent Peak Reverse Voltage	V _{RRM}	50	60	Volts
Working Peak Reverse Voltage	V _{RWS}	35	42	Volts
DC Blocking Voltage	V _{DC}	50	60	Volts
Maximum Average Forward Rectified Current See Fig.1	I _(AV)	15.0		Amps
Peak Forward Surge Current, 8.3ms single half sine-wave superimposed on rated load (JEDEC Method)	I _{FSM}	150		Amps
Maximum Instantaneous Forward Voltage Per Leg I _F = 7.5A, T _C = 125 °C (Note 2) I _F = 7.5A, T _C = 25 °C	V _F	.65	.75	Volts
Maximum Instantaneous Reverse Current at Rated DC Blocking Voltage per element T _C = 100 °C	I _R	50.0		mA
Maximum Instantaneous Reverse Current at Rated DC Blocking Voltage per element T _C = 25 °C	I _R	1.0		mA
Voltage Rate of Change, (Rated V _R)	dv/dt	1000		V/μs
Typical Thermal Resistance (Note 1)	R _{θJC}	3.5		°C/W
Maximum Operating Junction Temperature	T _C	-65 to +150		°C
Maximum Storage Temperature	T _{STG}	-65 to +150		°C

NOTES: 1. Thermal Resistance from Junction to Case per element.

2. 300 μs Pulse Width, 2% Duty Factor.

RATINGS AND CHARACTERISTIC CURVES MBRF1550CT AND MBRF1560CT

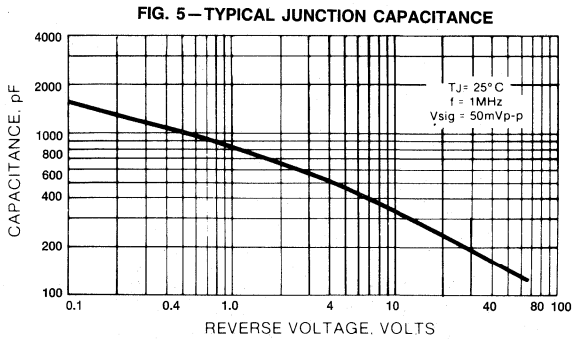
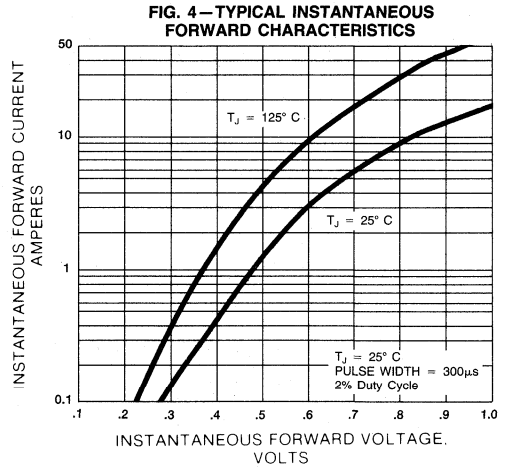
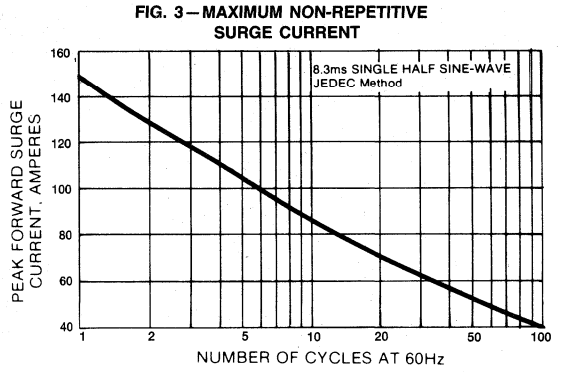
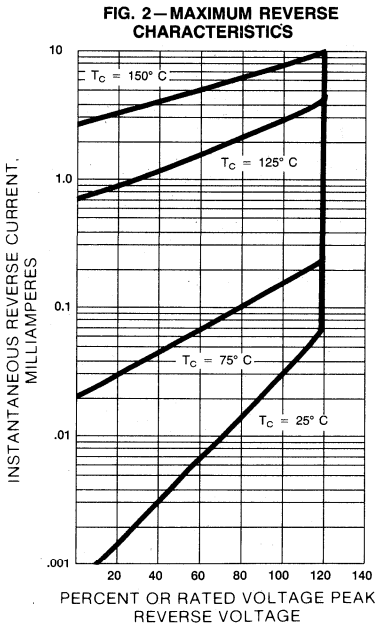
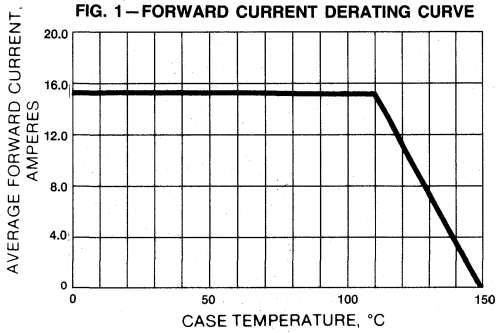

MBR1535CT AND MBR1545CT

SCHOTTKY RECTIFIER

VOLTAGE RANGE - 35 and 45 Volts CURRENT - 15 Amperes

FEATURES

- ◆ Plastic package has Underwriters Laboratory Flammability Classifications 94V-0
- ◆ Metal to silicon rectifier, majority carrier conduction
- ◆ Low power loss, high efficiency
- ◆ High current capability, low V_F
- ◆ High surge capacity
- ◆ Epitaxial construction
- ◆ For use in low voltage, high frequency inverters, free wheeling, and polarity protection applications
- ◆ High temperature soldering guaranteed: 250°C/10 seconds/.25", (6.35mm) from case
- ◆ Guard Ring for transient protection

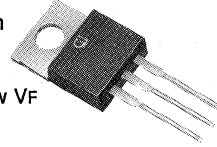

TO-220 CT

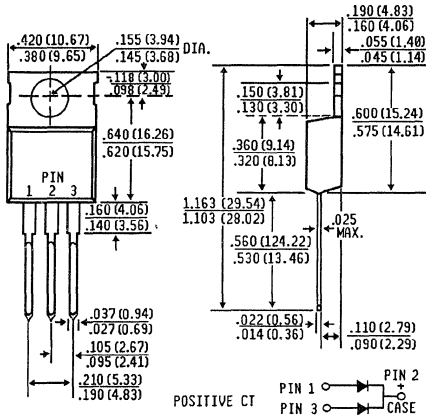

Dimensions in inches and (millimeters)

MECHANICAL DATA

Case: TO-220 Molded Plastic

Terminals: Solderable per MIL-STD- 202, Method 208

Polarity: As marked

Mounting Position: Any

Weight: .08 ounces, 2.24 gram

MAXIMUM RATINGS AND ELECTRICAL CHARACTERISTICS

Ratings at 25°C ambient temperature unless otherwise specified. Resistive or inductive load. For capacitive load, derate current by 20%.

	SYMBOLS	MBR1535CT	MBR1545CT	UNITS
Maximum Recurrent Peak Reverse Voltage	V _{RRM}	35	45	Volts
Working Peak Reverse Voltage	V _{VRM}	24.5	31.5	Volts
DC Blocking Voltage	V _{DC}	35	45	Volts
Maximum Average Forward Rectified Current at T _C = 105°C	I _(AV)	15.0		Amps
Peak Forward Surge Current 8.3ms single half sine-wave superimposed on rated load (JEDEC Method)	I _{FSM}	150		Amps
Peak Repetitive Reverse Surge Current (Note 3)	I _{RSM}	1.0		Amps
Maximum Instantaneous Forward Voltage Per Leg I _F = 7.5A, T _C = 125°C (Note 2) I _F = 15A, T _C = 125°C I _F = 15A, T _C = 25°C	V _F	0.57 0.72 0.84		Volts
Maximum Instantaneous Reverse Current at Rated DC Blocking Voltage per element T _C = 125°C	I _R	15		mA
Maximum Instantaneous Reverse Current at Rated DC Blocking Voltage per element T _C = 25°C	I _R	0.1		mA
Voltage Rate of Change, (Rated V _R)	dv/dt	1000		V/μs
Typical Thermal Resistance (Note 1)	R _{θJC}	3.0		°C/W
Maximum Operating Junction Temperature	T _J	-65 to +150		°C
Maximum Storage Temperature	T _{STG}	-65 to +175		°C

NOTES:

1. Thermal Resistance Junction to CASE.
2. 300 μs Pulse Width, 2% Duty Factor.
3. 2.0 μs, 1.0 KHz.

RATINGS AND CHARACTERISTIC CURVES MBR1535CT AND MBR1545CT

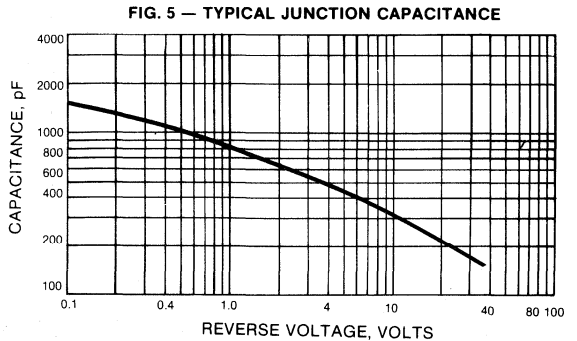
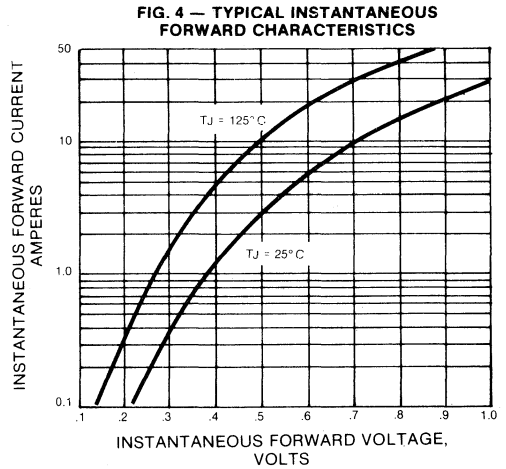
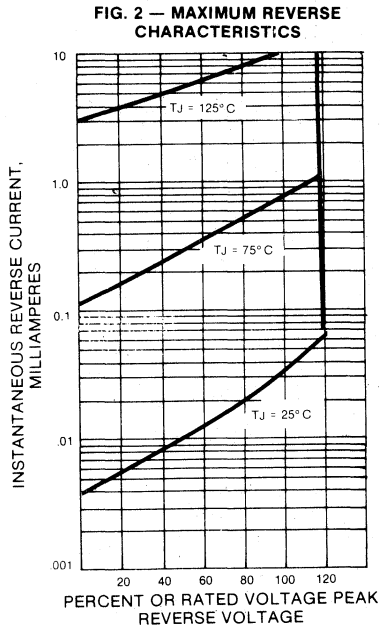
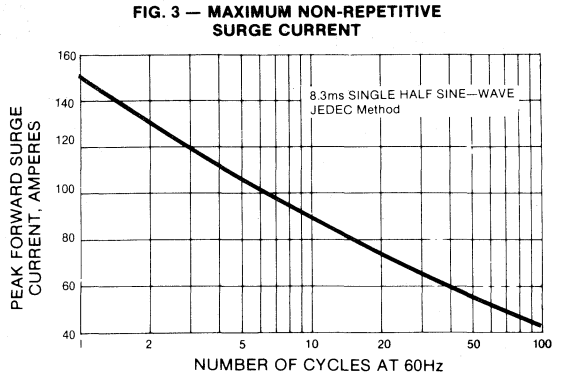
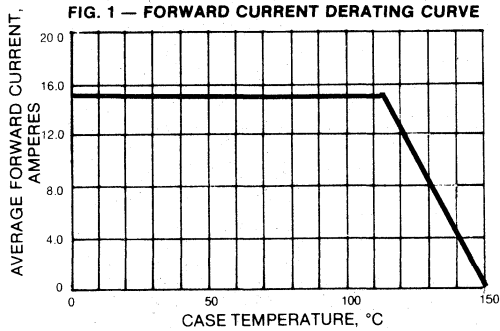

MBR1550CT AND MBR1560CT

SCHOTTKY RECTIFIER

VOLTAGE RANGE - 50 and 60 Volts CURRENT - 15 Amperes

FEATURES

- ◆ Plastic package has Underwriters Laboratory Flammability Classifications 94V-O
- ◆ Metal to silicon rectifier, majority carrier conduction
- ◆ Low power loss, high efficiency
- ◆ High current capability, low VF
- ◆ High surge capacity
- ◆ Epitaxial construction
- ◆ For use in low voltage, high frequency inverters, free wheeling, and polarity protection applications
- ◆ High temperature soldering guaranteed: 250°C/10 seconds/.25", (6.35mm) from case
- ◆ Guard Ring for transient protection

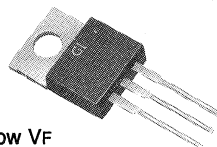

TO-220 CT

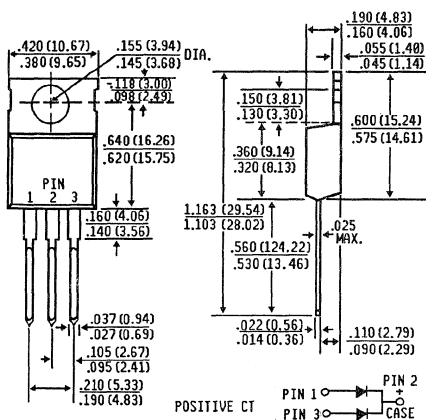

Dimensions in inches and (millimeters)

MECHANICAL DATA

Case: TO-220 Molded Plastic

Terminals: Solderable per MIL-STD-202, Method 208

Polarity: As marked

Mounting Position: Any

Weight: .08 ounces, 2.24 gram

MAXIMUM RATINGS AND ELECTRICAL CHARACTERISTICS

Ratings at 25 °C ambient temperature unless otherwise specified.

Resistive or inductive load.

For capacitive or inductive load, derate current by 20%.

	SYMBOLS	MBR1550CT	MBR1560CT	UNITS
Maximum Recurrent Peak Reverse Voltage	V _{RRM}	50	60	Volts
Maximum RMS Voltage	V _{RMS}	35	42	Volts
Maximum DC Blocking Voltage	V _{DC}	50	60	Volts
Maximum Average Forward Rectified Current at T _C = 105°C	I _(AV)	15.0		Amps
Peak Forward Surge Current, 8.3ms single half sine-wave superimposed on rated load (JEDEC Method)	I _{FSM}	150		Amps
Maximum Instantaneous Forward Voltage Per Leg I _F = 7.5A, T _C = 125°C (Note 2) I _F = 7.5A, T _C = 25°C	V _F	.65 .75		Volts
Maximum Average Reverse Current at T _C = 25°C Rated DC Blocking Voltage per element T _C = 100°C	I _R	1.0 50.0		mA
Typical Thermal Resistance (Note 1)	R _{ΘJC}	3.0		°C/W
Operating Temperature Range	T _C	-65 to +150		°C
Storage Temperature Range	T _{STG}	-65 to +150		°C

NOTES:

1. Thermal Resistance from Junction to Case.

2. 300 μs Pulse Width, 2% Duty Factor.

RATINGS AND CHARACTERISTIC CURVES MBR1550CT AND MBR1560CT

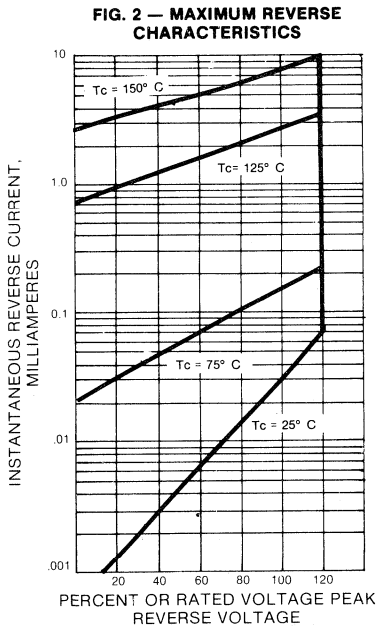
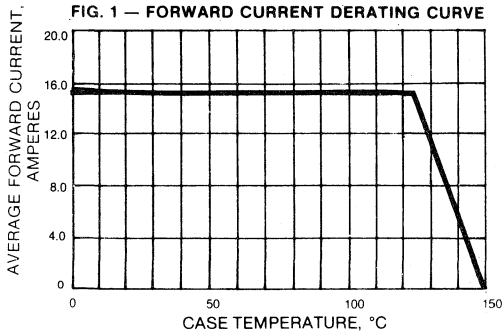

FIG. 3 — MAXIMUM NON-REPETITIVE SURGE CURRENT

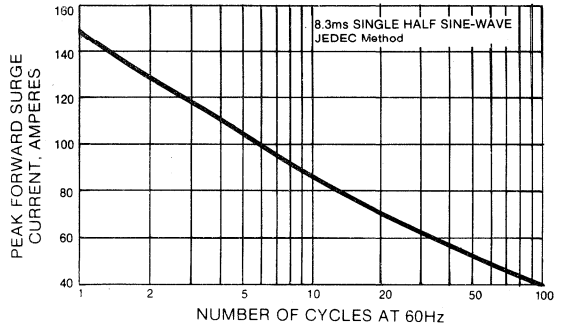

FIG. 4 — TYPICAL INSTANTANEOUS FORWARD CHARACTERISTICS

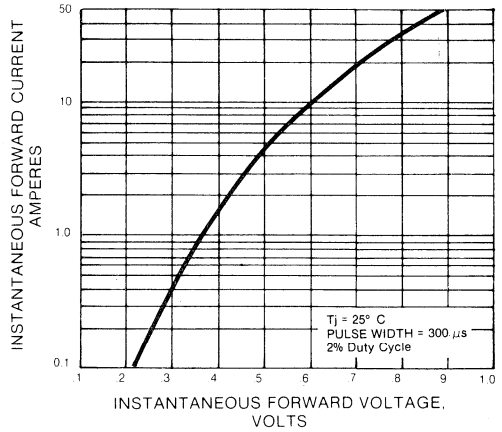
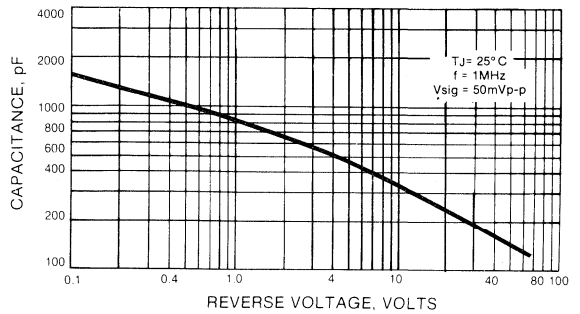

FIG. 5 — TYPICAL JUNCTION CAPACITANCE



MBRF1635 AND MBRF1645

SCHOTTKY RECTIFIER

VOLTAGE RANGE - 35 and 45 Volts CURRENT - 16 Amperes

FEATURES

- ◆ Isolated plastic package has Underwriters Laboratory Flammability Classifications 94V-0
- ◆ Metal to silicon rectifier, majority carrier conduction
- ◆ Low power loss, high efficiency
- ◆ High current capability, low V_F
- ◆ High surge capacity
- ◆ Epitaxial construction
- ◆ For use in low voltage, high frequency inverters, free wheeling, and polarity protection applications
- ◆ High temperature soldering guaranteed: 250°C/10 seconds/.25", (6.35mm) from case
- ◆ Guard Ring for transient protection
- ◆ Internal Insulation: 1.5k V_{RMS}

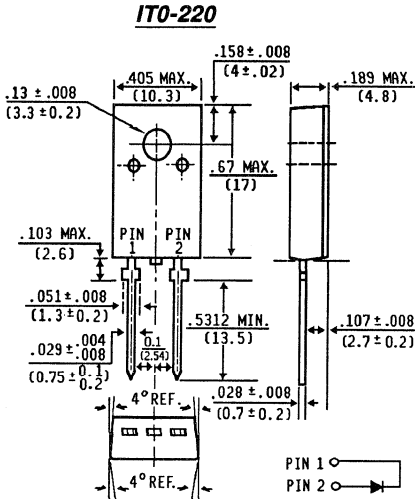
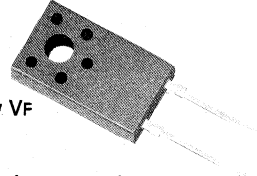

Dimensions in inches and (millimeters)

MECHANICAL DATA

Case: ITO-220 Molded Plastic

Terminals: Solderable per MIL-STD-202, Method 208

Polarity: As marked

Mounting Position: Any **Mounting Torque:** 5 in. -lbs. max.

Weight: .08 ounces, 2.24 grams

MAXIMUM RATINGS AND ELECTRICAL CHARACTERISTICS

Ratings at 25°C ambient temperature unless otherwise specified. Resistive or inductive load. For capacitive or inductive load, derate current by 20%.

	SYMBOLS	MBRF1635	MBRF1645	UNITS
Maximum Recurrent Peak Reverse Voltage	V _{RRM}	35	45	Volts
Working Peak Reverse Voltage	V _{RMS}	25	32	Volts
Maximum DC Blocking Voltage	V _{DC}	35	45	Volts
Maximum Average Forward Rectified Current See Fig.1	I _(AV)	16.0		Amps
Peak Repetitive Forward Current, Square Wave 20 KHz, 50% Duty Cycle at T _C = 125°C	I _{FSM}	32.0		Amps
Peak Forward Surge Current 8.3ms single half sine-wave superimposed on rated load (JEDEC Method)	I _{FSM}	150		Amps
Peak Repetitive Reverse Surge Current (2.0µs, 1KHz)	I _{RSM}	1.0		Amps
Voltage Rate of Change, (rated V _R)	dv/dt	1000		V/µs
Maximum Forward Voltage(Note 1) I _F =16A, T _C =125°C	V _F	0.57		Volts
I _F = 16A, T _C = 25°C	V _F	0.63		Volts
Maximum Instantaneous Reverse Current at Peak Reverse Voltage T _C = 125°C (Note 1)	I _R	40		mA
Maximum Instantaneous Reverse Current at Peak Reverse Voltage T _C = 25°C	I _R	0.2		mA
Maximum Thermal Resistance, Junction to Case	R _{θJC}	2.0		°C/W
Maximum Operating Junction Temperature	T _J	-65 to +150		°C
Maximum Storage Temperature	T _{STG}	-65 to +175		°C

NOTES: 1. Pulse Test Pulse Width 300 µs, Duty Cycle 2%.

RATINGS AND CHARACTERISTIC CURVES MBRF1635 AND MBRF1645

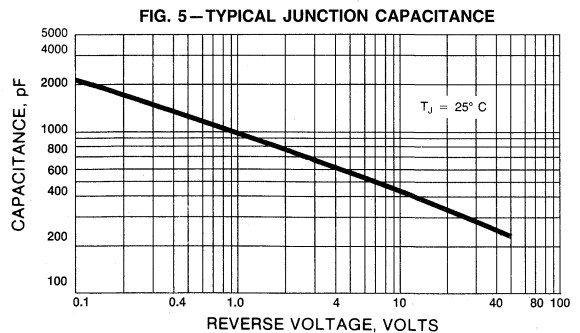
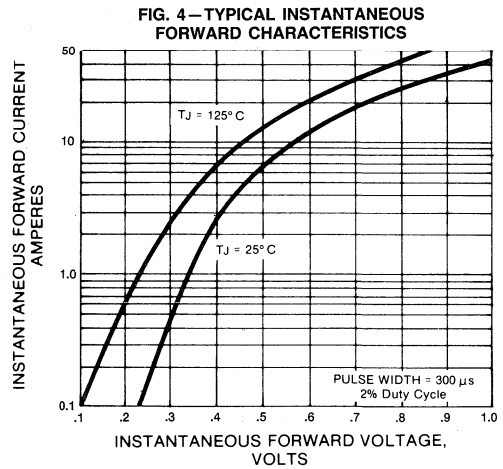
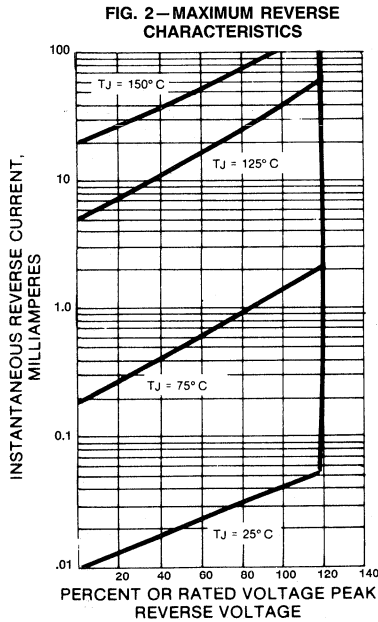
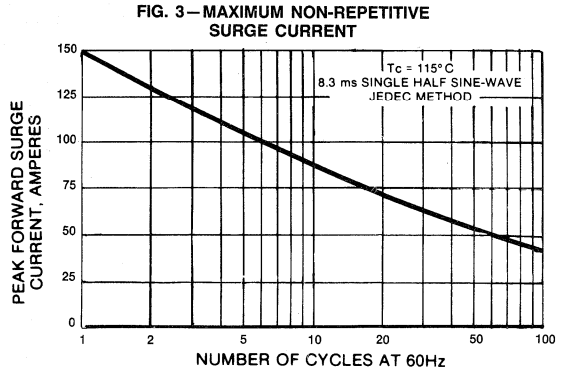
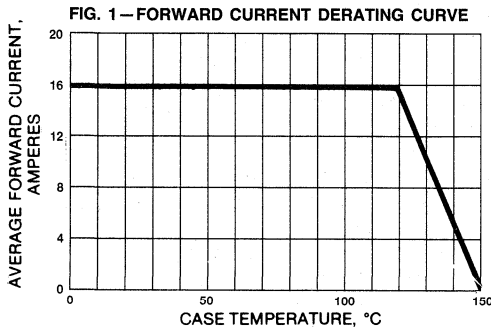

**GENERAL
INSTRUMENT**

MBRF1650 AND MBRF1660

SCHOTTKY RECTIFIER

VOLTAGE RANGE - 50 and 60 Volts CURRENT - 16 Amperes

FEATURES

- ◆ Isolated plastic package has Underwriters Laboratory Flammability Classifications 94V-0
- ◆ Metal to silicon rectifier, majority carrier conduction
- ◆ Low power loss, high efficiency
- ◆ High current capability, low VF
- ◆ High surge capacity
- ◆ Epitaxial construction
- ◆ For use in low voltage, high frequency inverters, free wheeling, and polarity protection applications
- ◆ High temperature soldering guaranteed: 250°C/10 seconds/.25", (6.35mm) from case
- ◆ Guard Ring for transient protection
- ◆ Internal Insulation: 1.5k VRMS

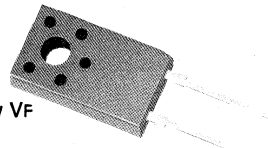

ITO-220

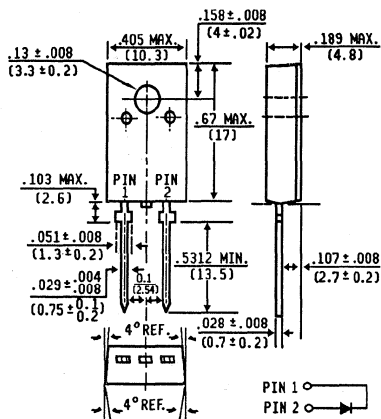

Dimensions in inches and (millimeters)

MECHANICAL DATA

Case: ITO-220 Molded Plastic

Terminals: Solderable per MIL-STD- 202, Method 208

Polarity: As marked

Mounting Position: Any **Mounting Torque:** 5 in. - lbs. max.

Weight: .08 ounces, 2.24 grams

MAXIMUM RATINGS AND ELECTRICAL CHARACTERISTICS

Ratings at 25°C ambient temperature unless otherwise specified. Resistive or inductive load. For capacitive or inductive load, derate current by 20%.

	SYMBOLS	MBRF1650	MBRF1660	UNITS
Maximum Recurrent Peak Reverse Voltage	V_{RRM}	50	60	Volts
Working Peak Reverse Voltage	V_{RMS}	35	42	Volts
Maximum DC Blocking Voltage	V_{DC}	50	60	Volts
Maximum Average Forward Rectified Current See Fig.1	$I_{(AV)}$	16.0		Amps
Peak Repetitive Forward Current, Square Wave 20 KHz, 50% Duty Cycle at $T_C = 125^\circ C$	I_{FSM}	32.0		Amps
Peak Forward Surge Current 8.3ms single half sine-wave superimposed on rated load (JEDEC Method)	I_{FSM}	150		Amps
Peak Repetitive Reverse Surge Current (2.0μs, 1KHz)	I_{RSM}	1.0		Amps
Voltage Rate of Change, (rated V_R)	dv/dt	1000		V/μs
Maximum Forward Voltage(Note 1) $I_F = 16A, T_C = 125^\circ C$ $I_F = 16A, T_C = 25^\circ C$	V_F V_F	0.65 0.75		Volts Volts
Maximum Instantaneous Reverse Current at Peak Reverse Voltage $T_C = 100^\circ C$ (Note 1)	I_R	50		mA
Maximum Instantaneous Reverse Current at Peak Reverse Voltage $T_C = 25^\circ C$	I_R	1.0		mA
Maximum Thermal Resistance, Junction to Case	$R_{\theta JC}$	2.0		$^\circ C/W$
Maximum Operating Junction Temperature	T_J	-65 to +150		$^\circ C$
Maximum Storage Temperature	T_{STG}	-65 to +175		$^\circ C$

NOTES:

1. Pulse Test Pulse Width 300 μs, Duty Cycle 2%.

RATINGS AND CHARACTERISTIC CURVES MBRF1650 AND MBRF1660

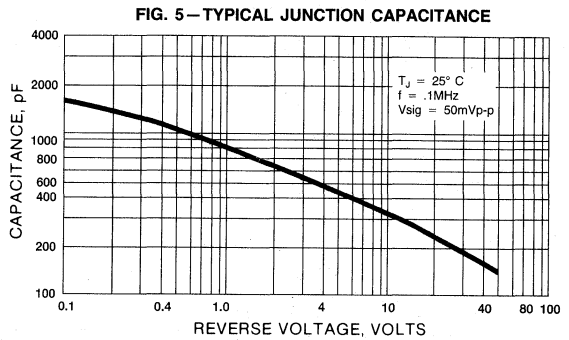
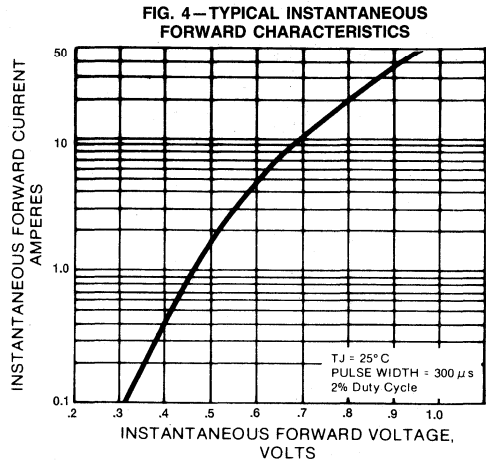
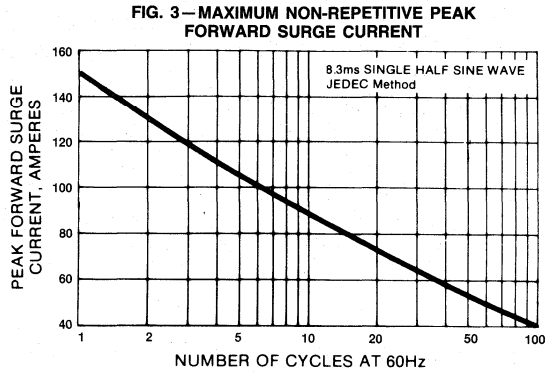
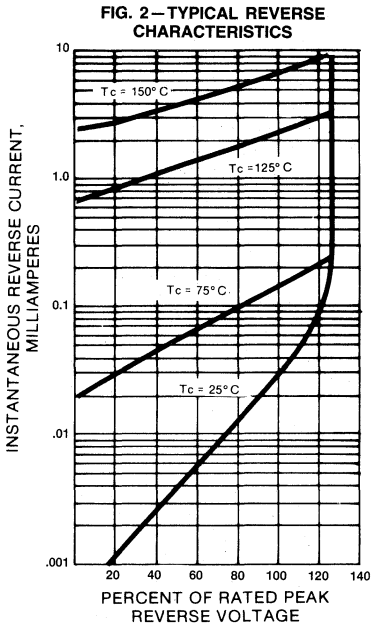
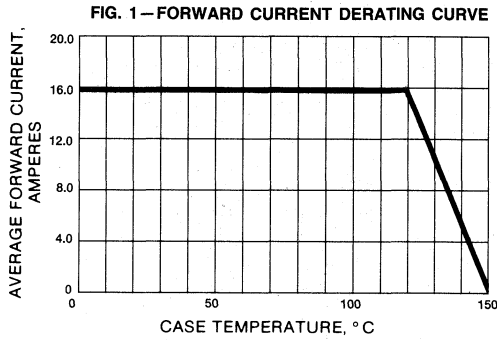

**GENERAL
INSTRUMENT**

MBR1635 AND MBR1645

SCHOTTKY RECTIFIER

VOLTAGE RANGE - 35 and 45 Volts CURRENT - 16 Amperes

FEATURES

TO-220

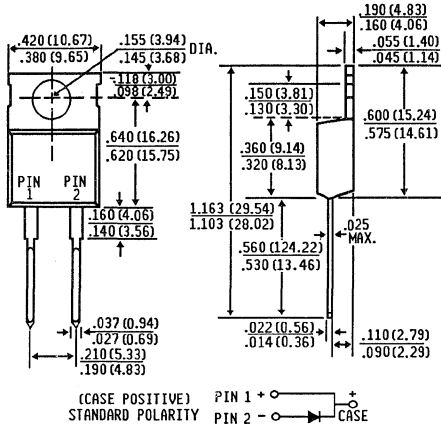

Dimensions in inches and (millimeters)

- ◆ Plastic package has Underwriters Laboratory Flammability Classifications 94V-O.
- ◆ Metal to silicon rectifier, majority carrier conduction
- ◆ Low power loss, high efficiency
- ◆ High current capability, low V_F
- ◆ High surge capacity
- ◆ Epitaxial construction
- ◆ For use in low voltage, high frequency inverters, free wheeling, and polarity protection applications
- ◆ High temperature soldering guaranteed: 250°C/10 seconds/.25", (6.35mm) from case
- ◆ Guard Ring for transient protection



MECHANICAL DATA

Case: TO-220 Molded Plastic

Terminals: Solderable per MIL-STD-202, Method 208

Polarity: As marked

Mounting Position: Any

Weight: .08 ounces, 2.24 gram

MAXIMUM RATINGS AND ELECTRICAL CHARACTERISTICS

Ratings at 25°C ambient temperature unless otherwise specified. Resistive or inductive load. For capacitive load, derate current by 20%.

	SYMBOLS	MBR1635	MBR1645	UNITS
Maximum Recurrent Peak Reverse Voltage	V_{RRM}	35	45	Volts
Working Peak Reverse Voltage	V_{RWM}	35	45	Volts
Maximum DC Blocking Voltage	V_{DC}	35	45	Volts
Maximum Average Forward Rectified Current at $T_C = 125^\circ C$	$I_{(AV)}$	16.0		Amps
Peak Repetitive Forward Current, Square Wave 20 KHz, 50% Duty Cycle at $T_C = 125^\circ C$	I_{FSM}	32.0		Amps
Peak Forward Surge Current 8.3ms single half sine-wave superimposed on rated load (JEDEC Method)	I_{FSM}	150		Amps
Peak Repetitive Reverse Surge Current (2.0μs, 1KHz)	I_{RSM}	1.0		Amps
Voltage Rate of Change, (rated V_R)	dv/dt	1000		V/μs
Maximum Forward Voltage(Note 1)				
$I_F = 16A, T_C = 125^\circ C$	V_F	0.57		Volts
$I_F = 16A, T_C = 25^\circ C$	V_F	0.63		Volts
Maximum Instantaneous Reverse Current at Peak Reverse Voltage $T_C = 125^\circ C$ (Note 1)	I_R	40		mA
Maximum Instantaneous Reverse Current at Peak Reverse Voltage $T_C = 25^\circ C$	I_R	0.2		mA
Maximum Thermal Resistance, Junction to Case	$R_{\theta JC}$	1.5		°C/W
Maximum Operating Junction Temperature	T_J	-65 to +175		°C
Maximum Storage Temperature	T_{STG}	-65 to +175		°C

NOTES:

1. Pulse Test Pulse Width 300 μs, Duty Cycle 2%.

RATINGS AND CHARACTERISTIC CURVES MBR1635 AND MBR1645

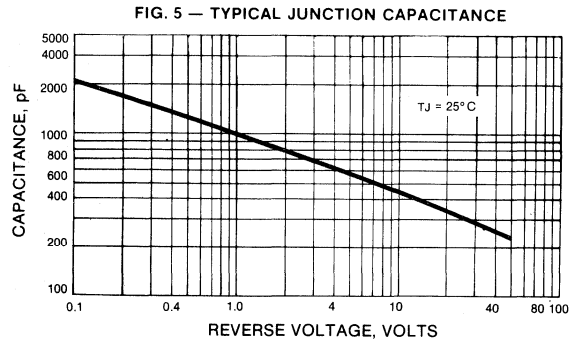
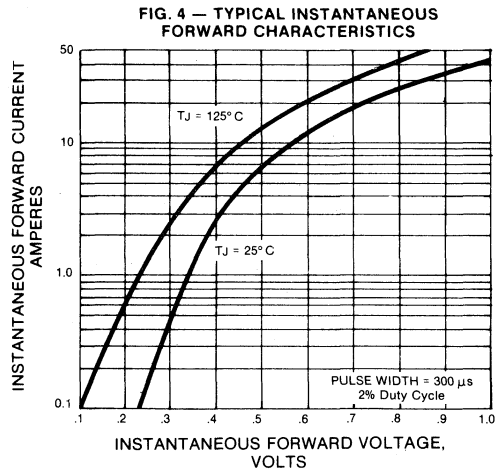
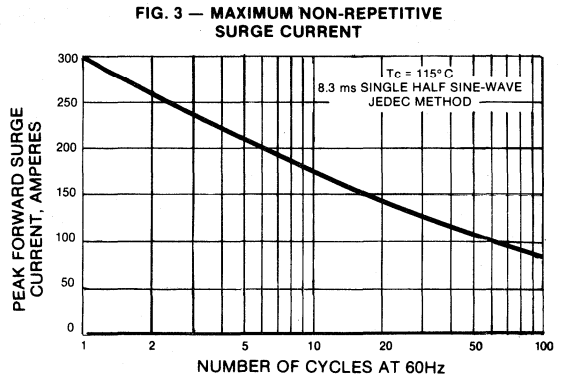
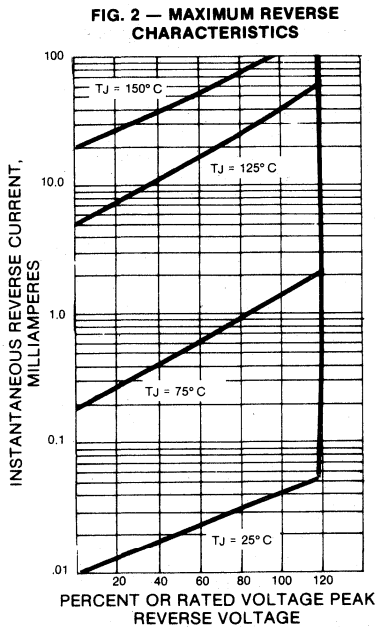
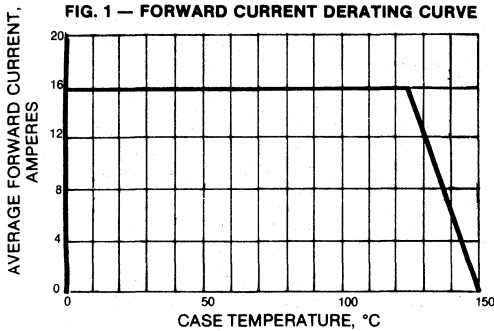

MBR1650 AND MBR1660

SCHOTTKY RECTIFIER

VOLTAGE RANGE - 50 and 60 Volts CURRENT - 16 Amperes

FEATURES

- ◆ Plastic package has Underwriters Laboratory Flammability Classifications 94V-O.
- ◆ Metal to silicon rectifier, majority carrier conduction
- ◆ Low power loss, high efficiency
- ◆ High current capability, low VF
- ◆ High surge capacity
- ◆ Epitaxial construction
- ◆ For use in low voltage, high frequency inverters, free wheeling, and polarity protection applications
- ◆ High temperature soldering guaranteed: 250°C/10 seconds/.25", (6.35mm) from case
- ◆ Guard Ring for transient protection

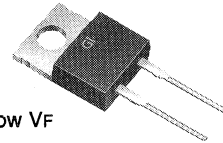

TO-220

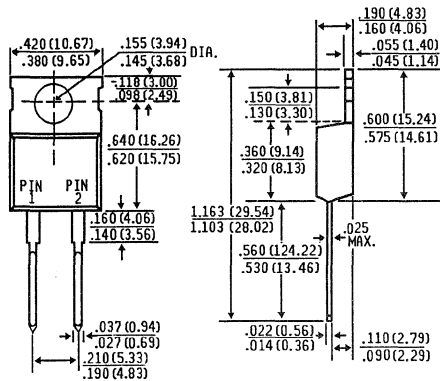

(CASE POSITIVE) PIN 1 +
STANDARD POLARITY PIN 2 - CASE

Dimensions in inches and (millimeters)

MECHANICAL DATA

Case: TO-220 Molded Plastic

Terminals: Solderable per MIL-STD-202, Method 208

Polarity: As marked

Mounting Position: Any

Weight: .08 ounces, 2.24 gram

MAXIMUM RATINGS AND ELECTRICAL CHARACTERISTICS

Ratings at 25°C ambient temperature unless otherwise specified. Resistive or inductive load.
For capacitive or inductive load, derate current by 20%.

	SYMBOLS	MBR1650	MBR1660	UNITS
Maximum Recurrent Peak Reverse Voltage	V_{RRM}	50	60	Volts
Maximum RMS Voltage	V_{RMS}	35	42	Volts
Maximum DC Blocking Voltage	V_{DC}	50	60	Volts
Maximum Average Forward Rectified Current see Fig. 1	$I_{(AV)}$	16.0		Amps
Peak Forward Surge Current, 8.3-ms single half sine-wave superimposed on rated load (JEDEC Method)	I_{FSM}	150		Amps
Maximum Instantaneous Forward Voltage Per Leg $I_F = 16A, T_C = 125^\circ C$ (Note 2) $I_F = 16A, T_C = 25^\circ C$	V_F	.65 .75		Volts
Maximum Average Reverse Current at $T_C = 25^\circ C$		1.0		
Rated DC Blocking Voltage per element $T_C = 100^\circ C$	I_R	50.0		mA
Typical Thermal Resistance (Note 1)	$R_{\theta JC}$	3.0		$^\circ C/W$
Operating Temperature Range	T_C	-65 to +150		$^\circ C$
Storage Temperature Range	T_{STG}	-65 to +150		$^\circ C$

NOTES:

1. Thermal Resistance from Junction to Case.
2. 300 μs Pulse Width, 2% Duty Factor.

RATINGS AND CHARACTERISTIC CURVES MBR1650 AND MBR1660

FIG. 1 — FORWARD CURRENT DERATING CURVE

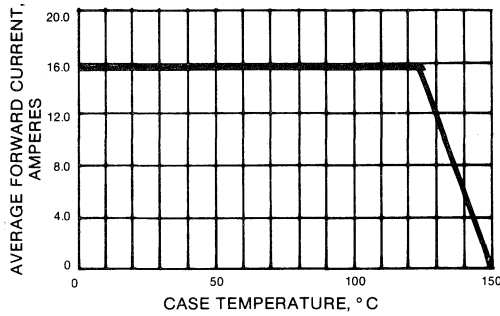

FIG. 2 — TYPICAL REVERSE CHARACTERISTICS

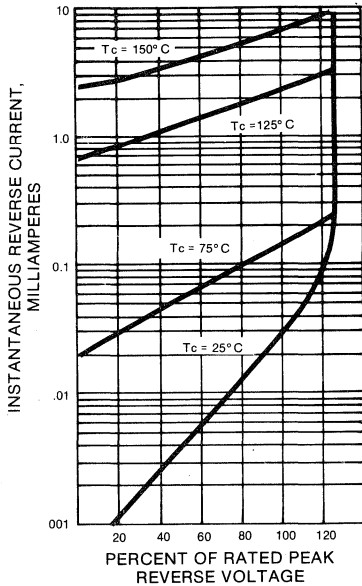

FIG. 3 — MAXIMUM NON-REPETITIVE PEAK FORWARD SURGE CURRENT

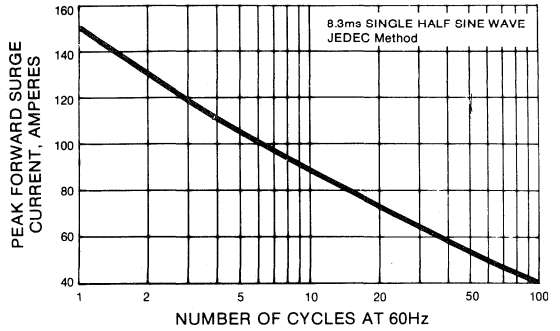

FIG. 4 — TYPICAL INSTANTANEOUS FORWARD CHARACTERISTICS

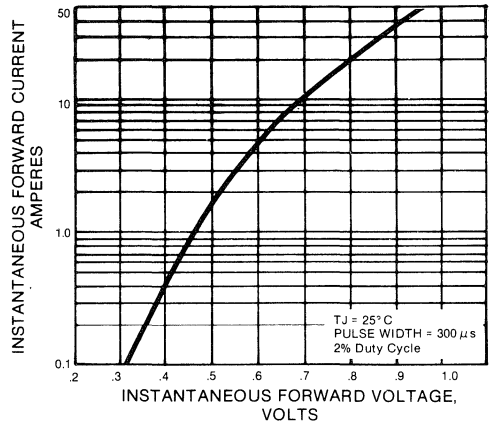
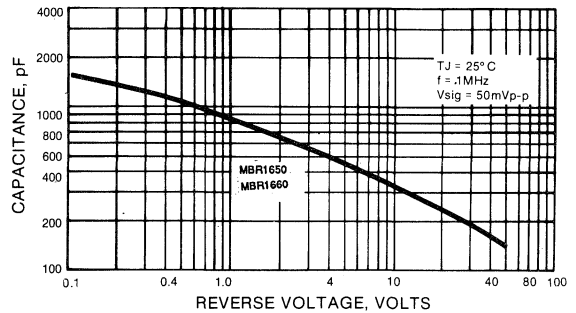

FIG. 5 — TYPICAL JUNCTION CAPACITANCE



SBLF1630CT AND SBLF1640CT

SCHOTTKY RECTIFIER

VOLTAGE RANGE - 30 and 40 Volts CURRENT - 16 Amperes

FEATURES

- ◆ Isolated overmolded package
- ◆ Metal to silicon rectifier, majority carrier conduction
- ◆ Low power loss, high efficiency
- ◆ High current capability, low VF
- ◆ High surge capacity
- ◆ Epitaxial construction
- ◆ Guard Ring for transient protection
- ◆ For use in low voltage, high frequency inverters, free wheeling, and polarity protection applications
- ◆ High temperature soldering guaranteed: 250°C/10 seconds/.25", (6.35mm) from case
- ◆ Guard Ring for transient protection
- ◆ Internal Insulation: 1.5K VRMS

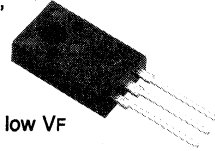

ITO-220 CT

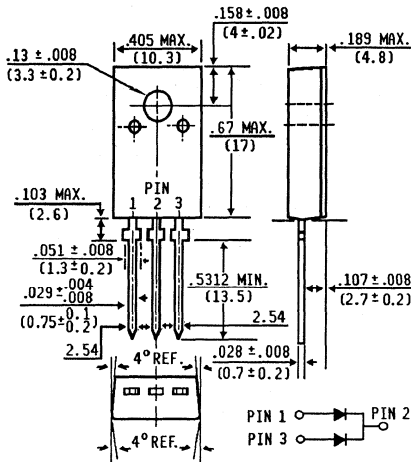

Dimensions in inches
and
(millimeters)

MECHANICAL DATA

Case: ITO-220 Fully overmolded Plastic

Terminals: Solderable per MIL-STD-202, Method 208

Polarity: As marked

Mounting Position: Any

Mounting Torque: 5 in-lbs max.

Weight: .08 ounces, 2.24 grams

MAXIMUM RATINGS AND ELECTRICAL CHARACTERISTICS

Ratings at 25 °C ambient temperature unless otherwise specified.

Resistive or inductive load.

For capacitive or inductive load, derate current by 20%.

	SYMBOLS	SBLF1630CT	SBLF1640CT	UNITS
Maximum Recurrent Peak Reverse Voltage	V_{RRM}	30	40	Volts
Maximum RMS Voltage	V_{RMS}	21	28	Volts
Maximum DC Blocking Voltage	V_{DC}	30	40	Volts
Maximum Average Forward Rectified Current See Fig. 1	$I_{(AV)}$	16.0		Amps
Peak Forward Surge Current, 8.3ms single half sine-wave superimposed on rated load (JEDEC Method)	I_{FSM}	250		Amps
Maximum Instantaneous Forward Voltage Per Leg $I_F = 8.0A, T_c = 25^\circ C$ (Note 2)	V_F	.55		Volts
Maximum Average Reverse Current at $T_c = 25^\circ C$		1.0		
Rated DC Blocking Voltage per element $T_c = 100^\circ C$	I_R	50.0		mA
Typical Thermal Resistance (Note 1)	$R_{\theta JC}$	2.2		°C/W
Operating Temperature Range	T_c	-40 to +125		°C
Storage Temperature Range	T_{STG}	-40 to +150		°C

NOTES:

1. Thermal Resistance from Junction to Case per element.

2. 300 μs Pulse Width, 2% Duty Factor.

RATINGS AND CHARACTERISTIC CURVES SBLF1630CT AND SBLF1640CT

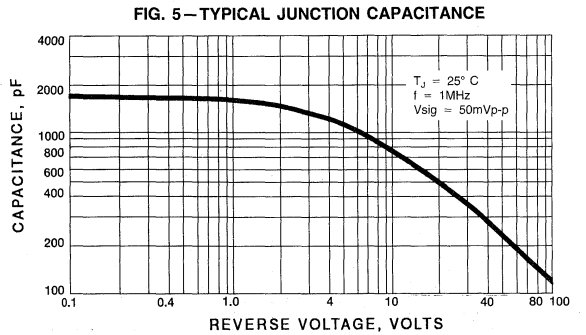
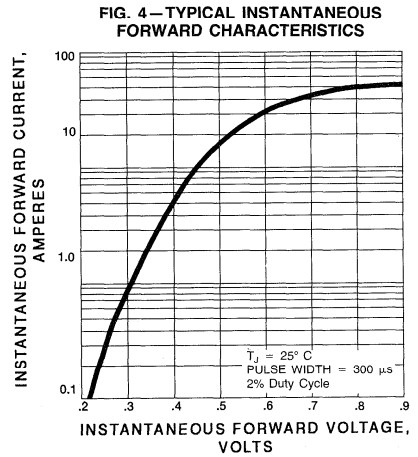
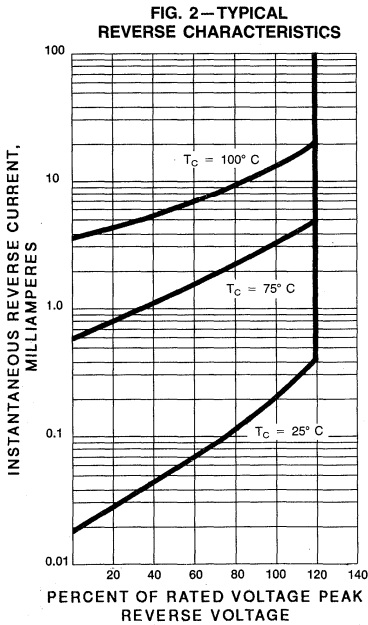
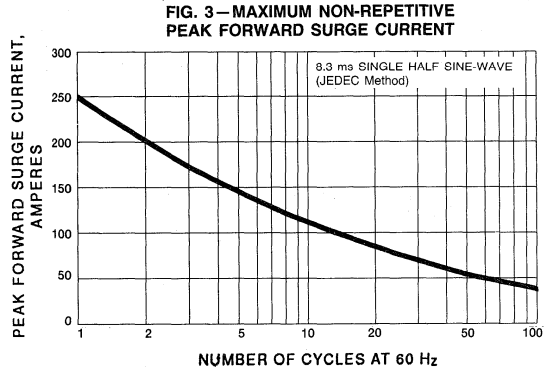
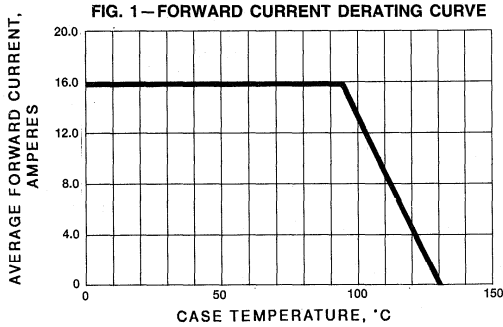

SBL1630CT AND SBL1640CT

SCHOTTKY RECTIFIER

VOLTAGE RANGE - 30 and 40 Volts CURRENT -16 Amperes

FEATURES

- ◆ Plastic package had Underwriters Laboratory Flammability Classifications 94V-O
- ◆ Metal to silicon rectifier, majority carrier conduction
- ◆ Low power loss, high efficiency
- ◆ High current capability, low VF
- ◆ High surge capacity
- ◆ Epitaxial construction
- ◆ For use in low voltage, high frequency inverters, free wheeling, and polarity protection applications
- ◆ High temperature soldering guaranteed: 250°C/10 seconds/.25", (6.35mm) from case
- ◆ Guard Ring for transient protection

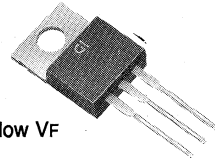

TO-220 CT

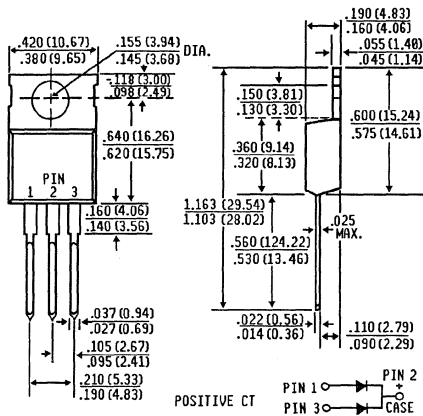

Dimensions in inches and (millimeters)

MECHANICAL DATA

Case: TO-220 Molded Plastic

Terminals: Solderable per MIL-STD- 202, Method 208

Polarity: As marked

Mounting Position: Any

Weight: .08 ounces, 2.24 gram

CROSS REFERENCE GUIDE

GI	FUJI	SHINDENGEN
SBL1640CT	ESAD82-004	---

MAXIMUM RATINGS AND ELECTRICAL CHARACTERISTICS

Ratings at 25 °C ambient temperature unless otherwise specified.
Resistive or inductive load.
For capacitive or inductive load, derate current by 20%.

SYMBOLS	SBL1630CT	SBL1640CT	UNITS	
Maximum Recurrent Peak Reverse Voltage	V _{RRM}	30	40	Volts
Maximum RMS Voltage	V _{RMS}	21	28	Volts
Maximum DC Blocking Voltage	V _{DC}	30	40	Volts
Maximum Average Forward Rectified Current at T _C = 95°C	I _(AV)	16.0		Amps
Peak Forward Surge Current, 8.3ms single half sine-wave superimposed on rated load (JEDEC Method)	I _{FSM}	250		Amps
Maximum Instantaneous Forward Voltage Per Leg I _F = 8.0A, T _C = 25°C (Note 2)	V _F	.55		Volts
Maximum Average Reverse Current at T _C = 25°C	I _R	0.5		mA
Rated DC Blocking Voltage per element T _C = 100°C	I _R	50.0		mA
Typical Thermal Resistance (Note 1)	R _{θJC}	3.0		°C/W
Operating Temperature Range	T _C	-40 to +125		°C
Storage Temperature Range	T _{STG}	-40 to +150		°C

NOTES:

1. Thermal Resistance from Junction to Case.
2. 300 μs Pulse Width, 2% Duty Factor.

RATINGS AND CHARACTERISTIC CURVES SBL1630CT AND SBL1640CT

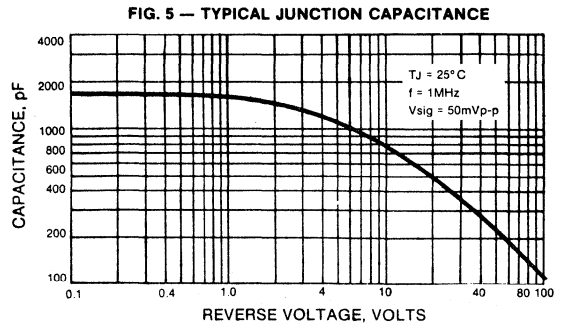
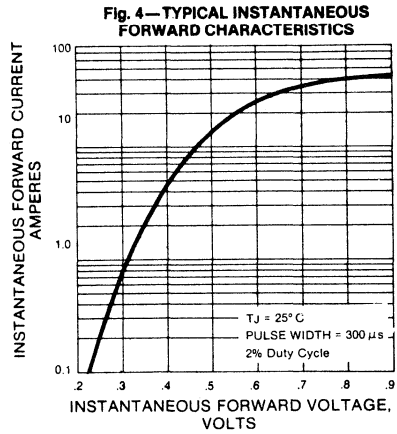
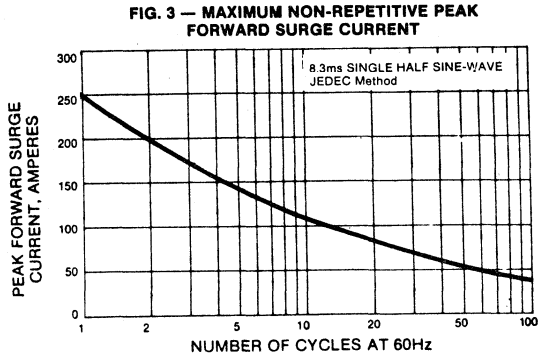
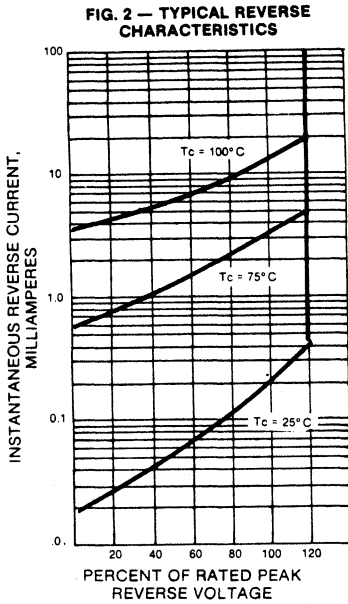
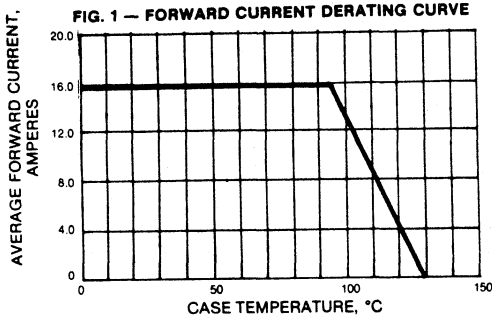

MBRF2035CT AND MBRF2045CT

SCHOTTKY RECTIFIER

VOLTAGE RANGE - 35 and 45 Volts CURRENT - 20 Amperes

FEATURES

- ◆ Isolated plastic package has Underwriters Classification 94-V-O
- ◆ Metal to silicon rectifier, majority carrier conduction
- ◆ Low power loss, high efficiency
- ◆ High current capability, low VF
- ◆ High surge capacity
- ◆ Epitaxial construction
- ◆ Guard Ring for transient protection
- ◆ For use in low voltage, high frequency inverters, free wheeling, and polarity protection applications
- ◆ High temperature soldering guaranteed: 250°C/10 seconds/.25", (6.35mm) from case
- ◆ Internal Insulation: 1.5k VRMS

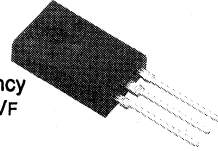

ITO-220 CT

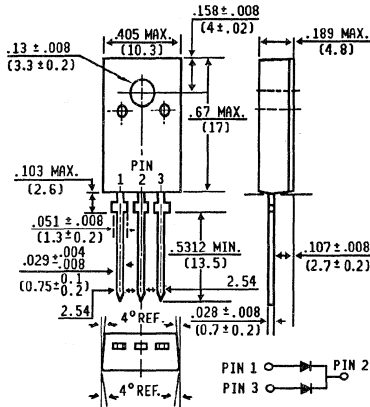

Dimensions in inches and millimeters

MECHANICAL DATA

Case: ITO-220 molded Plastic
Terminals: Solderable per MIL-STD-202, Method 208
Polarity: As marked
Mounting Position: Any
Mounting Torque: 5 in.- lbs. max.
Weight: .08 ounces, 2.24 grams

MAXIMUM RATINGS AND ELECTRICAL CHARACTERISTICS

Ratings at 25°C ambient temperature unless otherwise specified. Resistive or inductive load. For capacitive or inductive load, derate current by 20%.

	SYMBOLS	MBRF2035CT	MBRF2045CT	UNITS
Maximum Recurrent Peak Reverse Voltage	V_{RRM}	35	45	Volts
Working Peak Reverse Voltage	V_{RM}	24.5	31.5	Volts
Maximum DC Blocking Voltage	V_{DC}	35	45	Volts
Maximum Average Forward Rectified Current See Fig. 1	$I_{(AV)}$	20		Amps
Peak Forward Surge Current 8.3ms single half sine-wave superimposed on rated load (JEDEC Method)	I_{FSM}	150		Amps
Peak Repetitive Reverse Surge Current (Note 3)	I_{RRM}	1.0		Amps
Maximum Forward Voltage Per Leg	V_F		0.57 0.72 0.84	Volts
			$I_F = 10A, T_C = 125^\circ C$	
			$I_F = 20A, T_C = 125^\circ C$	
			$I_F = 20A, T_C = 25^\circ C$	
Maximum Instantaneous Reverse Current at Rated DC Blocking Voltage per element $T_C = 125^\circ C$	I_R	25		mA
Maximum Instantaneous Reverse Current at Rated DC Blocking Voltage $T_C = 25^\circ C$	I_R	0.1		mA
Voltage Rate of Change, (Rated V_R)	dv/dt	1000		V μ s
Typical Thermal Resistance (Note 1)	$R_{\theta JC}$	2.2		°C/W
Maximum Operating Junction Temperature	T_J	-65 to +150		°C
Maximum Storage Temperature	T_{STG}	-65 to +175		°C

NOTES: 1. Thermal Resistance to Case per element. 2. 300 μ s Pulse Width 300 μ s, 2% Duty Factor. 3. 2.0 μ s, 1KHz.

RATINGS AND CHARACTERISTIC CURVES MBRF2035CT AND MBRF2045CT

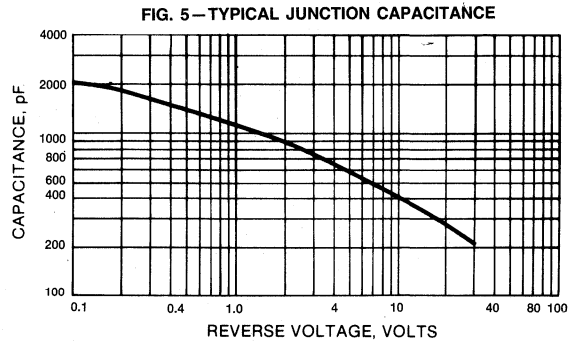
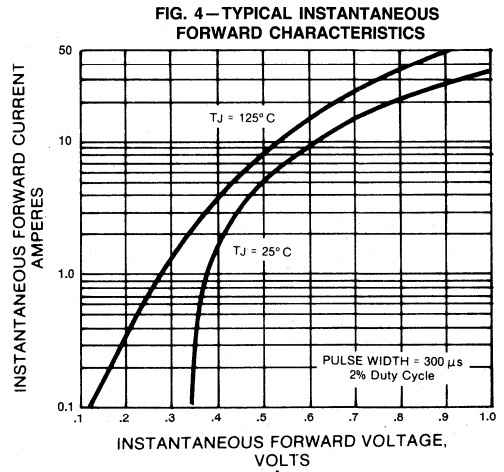
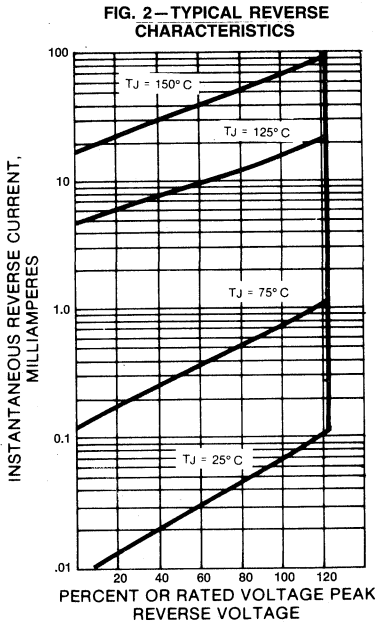
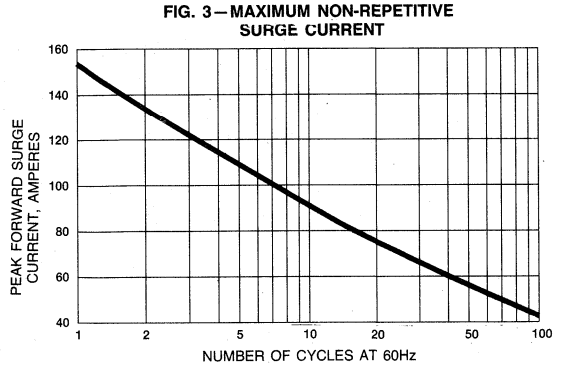
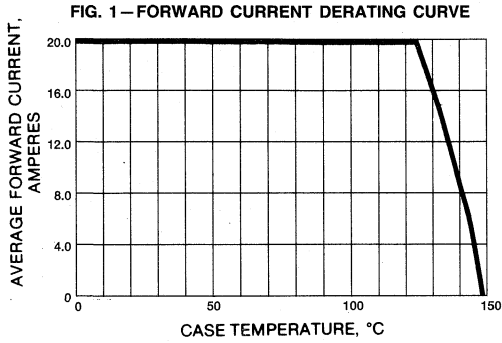

GENERAL INSTRUMENT

MBRF2050CT AND MBRF2060CT

SCHOTTKY RECTIFIER

VOLTAGE RANGE - 50 and 60 Volts CURRENT - 20 Amperes

FEATURES

- ◆ Isolated plastic package has Underwriters Laboratory Flammability Classification 94 V-O
- ◆ Metal to silicon rectifier, majority carrier conduction
- ◆ Low power loss, high efficiency
- ◆ High current capability, low VF
- ◆ High surge capacity
- ◆ Epitaxial construction
- ◆ For use in low voltage, high frequency inverters, free wheeling, and polarity protection applications
- ◆ High temperature soldering guaranteed: 250°C/10 seconds/.25", (6.35mm) from case
- ◆ Guard Ring for transient protection
- ◆ Internal Insulation: 1.5k VRMS

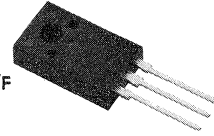

ITO-220 CT

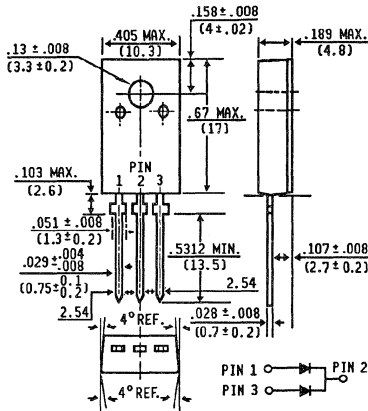

Dimensions in inches and (millimeters)

MECHANICAL DATA

Case: ITO-220 fully over molded Plastic

Terminals: Lead solderable per MIL-STD-202 Method 208

Polarity: As marked

Mounting Position: Any **Mounting Torque:** 5 in-lbs max.

Weight: .08 ounces, 2.24 grams

MAXIMUM RATINGS AND ELECTRICAL CHARACTERISTICS

Ratings at 25°C ambient temperature unless otherwise specified. Resistive or inductive load. For capacitive or inductive load, derate current by 20%.

	SYMBOLS	MBRF2050CT	MBRF2060CT	UNITS
Maximum Recurrent Peak Reverse Voltage	V _{RRM}	50	60	Volts
Working Peak Reverse Voltage	V _{RM}	50	60	Volts
Maximum DC Blocking Voltage	V _{DC}	50	60	Volts
Maximum Average Forward Rectified Current See Fig.1	I _(AV)	20		Amps
Peak Forward Surge Current 8.3ms single half sine-wave superimposed on rated load (JEDEC Method)	I _{FSM}	150		Amps
Peak Repetitive Reverse Surge Current (Note 3)	I _{RRM}	1.0		Amps
Maximum Forward Voltage Per Leg (Note 2)	V _F	0.70 0.85 0.95		Volts
		I _F = 10A, T _C = 125°C I _F = 20A, T _C = 125°C I _F = 20A, T _C = 25°C		
Maximum Instantaneous Reverse Current at Rated DC Blocking Voltage per element T _C = 125°C	I _R	25		mA
Maximum Instantaneous Reverse Current at Rated DC Blocking Voltage T _C = 25°C	I _R	0.1		mA
Voltage Rate of Change, (Rated V _R)	dv/dt	1000		V/μs
Typical Thermal Resistance (Note 1)	R _{θJC}	2.2		°C/W
Maximum Operating Junction Temperature	T _J	-65 to +150		°C
Maximum Storage Temperature	T _{STG}	-65 to +175		°C

NOTES: 1. Thermal Resistance Junction to Case. 2. 300 μs Pulse Width 300 us, 2% Duty Factor. 3. 2.0 μs, 1KHz.

RATINGS AND CHARACTERISTIC CURVES MBRF2050CT AND MBRF2060CT

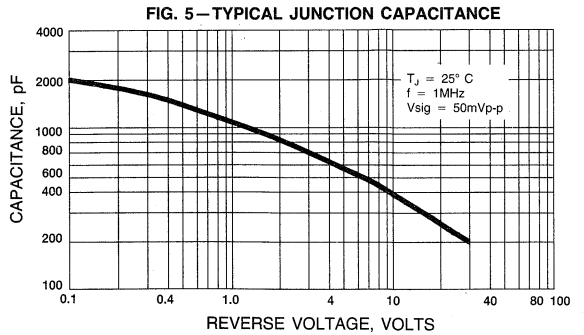
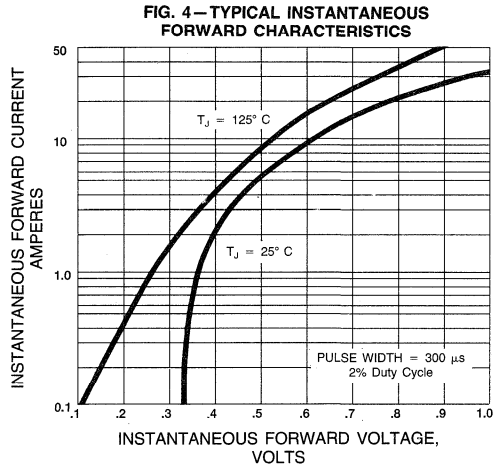
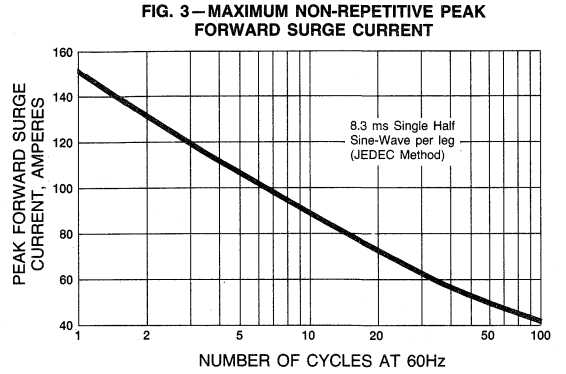
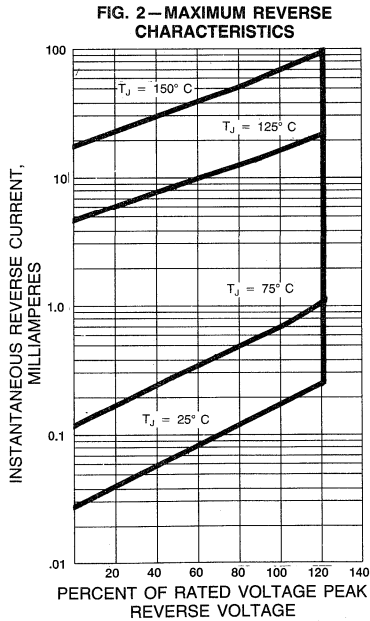
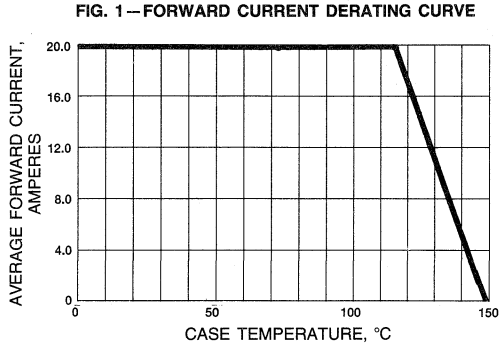

MBRF2090CT AND MBRF20100CT

SCHOTTKY RECTIFIER

VOLTAGE RANGE -90 and 100 Volts CURRENT - 20 Amperes

FEATURES

- ◆ Isolated plastic package has Underwriters Laboratory Flammability Classifications 94V-O
- ◆ Metal to silicon rectifier, majority carrier conduction
- ◆ Low power loss, high efficiency
- ◆ High current capability, low VF
- ◆ High surge capacity
- ◆ Epitaxial construction
- ◆ For use in low voltage, high frequency inverters, free wheeling, and polarity protection applications
- ◆ Guard Ring for transient protection
- ◆ Internal Insulation: 1.5k VRMS

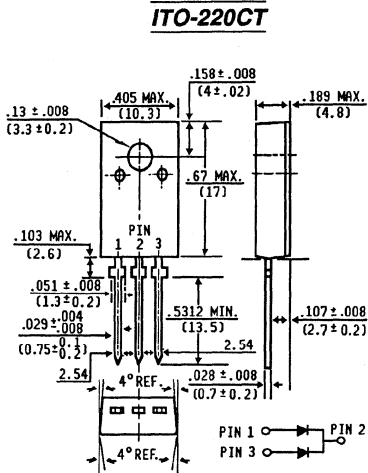
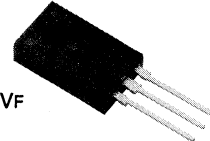

Dimensions in inches and (millimeters)

MECHANICAL DATA

Case: ITO-220 Molded Plastic

Terminals: Solderable per MIL-STD- 202, Method 208

Polarity: As marked

Mounting Position: Any

Mounting Torque: 5 in. - lbs. max.

Weight: .08 ounces, 2.24 grams

MAXIMUM RATINGS AND ELECTRICAL CHARACTERISTICS

Ratings at 25°C ambient temperature unless otherwise specified. Resistive or inductive load. For capacitive or inductive load, derate current by 20%.

	SYMBOLS	MBRF2090CT	MBRF20100CT	UNITS
Maximum Recurrent Peak Reverse Voltage	V _{RRM}	90	100	Volts
Working Peak Reverse Voltage	V _{RMS}	64	71	Volts
DC Blocking Voltage	V _{DC}	90	100	Volts
Maximum Average Forward Rectified Current See Fig.1	I _(AV)	20		Amps
Peak Repetitive Forward Current, (Square Wave 20 KHz) at T _C = 125°C	I _{FSM}	40		Amps
Peak Forward Surge Current 8.3ms single half sine-wave superimposed on rated load (JEDEC Method)	I _{FSM}	150		Amps
Peak Repetitive Reverse Surge Current (2.0us, 1KHz)	I _{RSM}	1.0		Amps
Voltage Rate of Change, dv/dt (rated V _R)	V/μs	1000		V/μs
Maximum Forward Voltage (Note 1) I _F = 10A, T _C = 25°C I _F = 10A, T _C = 125°C I _F = 20A, T _C = 125°C I _F = 20A, T _C = 25°C	V _F	0.80 0.70 0.85 0.95		Volts
Maximum Instantaneous Reverse Current at Peak Reverse Voltage T _C = 125°C (Note 1)	I _R	25.0		mA
Peak Reverse Voltage T _C = 25°C	I _R	0.1		mA
Maximum Thermal Resistance, Junction to Case per element	R _{θJC}	2.2		°C/W
Maximum Operating Junction Temperature	T _C	-65 to +150		°C
Maximum Storage Temperature	T _{STG}	-65 to +175		°C

NOTES: 1. Pulse Test Pulse Width 300 μs, Duty Cycle 2%.

RATINGS AND CHARACTERISTIC CURVES MBRF2090CT AND MBRF20100CT

FIG. 1 — FORWARD CURRENT DERATING CURVE

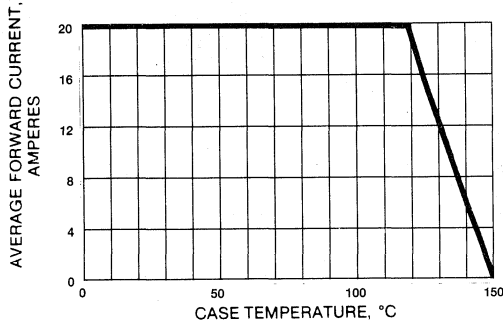

FIG. 2 — TYPICAL REVERSE CHARACTERISTICS

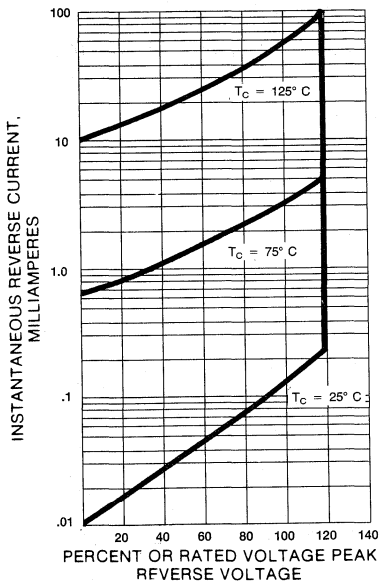

FIG. 3 — MAXIMUM NON-REPETITIVE PEAK FORWARD SURGE CURRENT

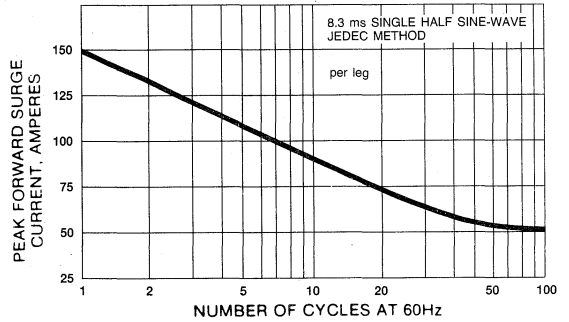

FIG. 4 — TYPICAL INSTANTANEOUS FORWARD CHARACTERISTICS

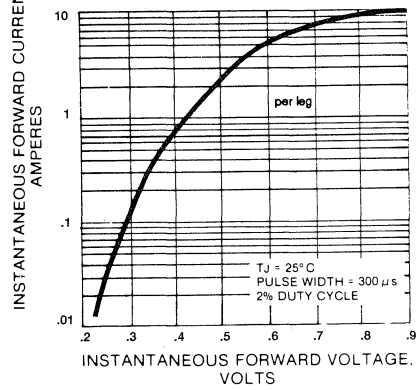
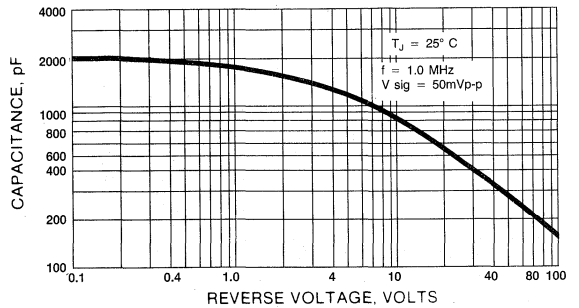

FIG. 5 — TYPICAL JUNCTION CAPACITANCE



MBR2035CT AND MBR2045CT

SCHOTTKY RECTIFIER

VOLTAGE RANGE - 35 and 45 Volts CURRENT - 20 Amperes

FEATURES

- ◆ Metal to silicon rectifier, majority carrier conduction
- ◆ Low power loss, high efficiency
- ◆ High current capability, low VF
- ◆ High surge capacity
- ◆ Epitaxial construction
- ◆ Guard Ring for transient protection
- ◆ For use in low voltage, high frequency inverters, free wheeling, and polarity protection applications
- ◆ High temperature soldering guaranteed: 250°C/10 seconds/.25", (6.35mm) from case

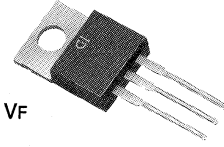

TO-220 CT

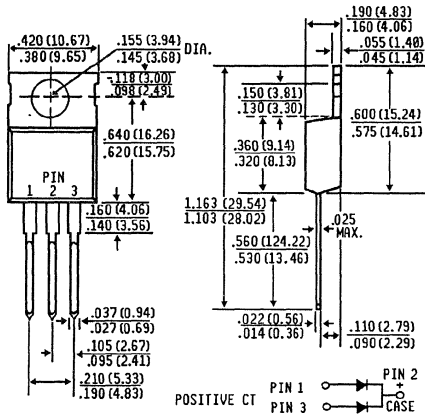

Dimensions in inches and (millimeters)

MECHANICAL DATA

Case: TO-220 molded Plastic
Terminals: Solderable per MIL-STD- 202, Method 208
Polarity: As marked
Mounting Position: Any
Weight: .08 ounces, 2.24 grams

MAXIMUM RATINGS AND ELECTRICAL CHARACTERISTICS

Ratings at 25°C ambient temperature unless otherwise specified. Resistive or inductive load. For capacitive load, derate current by 20%.

	SYMBOLS	MBR2035CT	MBR2045CT	UNITS
Maximum Recurrent Peak Reverse Voltage	V _{RRM}	35	45	Volts
Working Peak Reverse Voltage	V _{RM}	24.5	31.5	Volts
Maximum DC Blocking Voltage	V _{DC}	35	45	Volts
Maximum Average Forward Rectified Current See Fig.1	I <sub(av)< sub=""></sub(av)<>	20		Amps
Peak Forward Surge Current 8.3ms single half sine-wave superimposed on rated load (JEDEC Method)	I _{FSM}	150		Amps
Peak Repetitive Reverse Surge Current (Note 3)	I _{RRM}	1.0		Amps
Maximum Forward Voltage Per Leg (Note 2)	V _F		0.57 0.72 0.84	Volts
		I _F = 10A, T _C = 125°C		
		I _F = 20A, T _C = 125°C		
		I _F = 20A, T _C = 25°C		
Maximum Instantaneous Reverse Current at Rated DC Blocking Voltage per element T _C = 125°C	I _R	15		mA
Maximum Instantaneous Reverse Current at Rated DC Blocking Voltage T _C = 25°C	I _R	0.1		mA
Voltage Rate of Change, (Rated V _R)	dv/dt	1000		V/μs
Typical Thermal Resistance (Note 1)	R _{θJC}	2.0		°C/W
Maximum Operating Junction Temperature	T _J	-65 to +150		°C
Maximum Storage Temperature	T _{STG}	-65 to +175		°C

- NOTES: 1. Thermal Resistance Junction to CASE.
 2. 300 μs Pulse Width 300 us, 2% Duty Factor.
 3. 2.0 μs, 1KHz.

MBR2050CT AND MBR2060CT

SCHOTTKY RECTIFIER

VOLTAGE RANGE - 50 and 60 Volts CURRENT - 20 Amperes

FEATURES

- ◆ Plastic package has Underwriters Laboratory Flammability Classification 94 V-O
- ◆ Metal to silicon rectifier, majority carrier conduction
- ◆ Low power loss, high efficiency
- ◆ High current capability, low V_F
- ◆ High surge capacity
- ◆ Epitaxial construction
- ◆ For use in low voltage, high frequency inverters, free wheeling, and polarity protection applications
- ◆ High temperature soldering guaranteed: 250°C/10 seconds/.25", (6.35mm) from case
- ◆ Guard Ring for transient protection

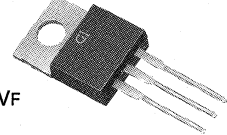

TO-220 CT

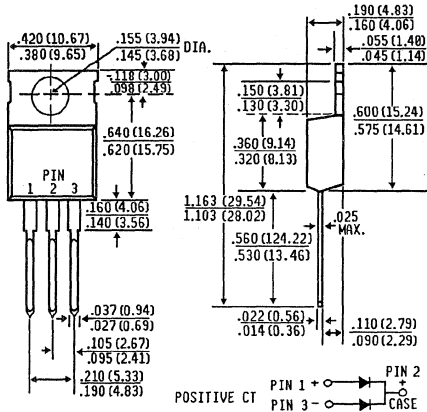

Dimensions in inches and (millimeters)

MECHANICAL DATA

Case: TO-220 Molded Plastic

Terminals: Leads, solderable per MIL-STD- 202, Method 208

Polarity: As marked

Mounting Position: Any

Weight: .08 ounces, 2.24 gram

MAXIMUM RATINGS AND ELECTRICAL CHARACTERISTICS

Ratings at 25°C ambient temperature unless otherwise specified. Resistive or inductive load. For capacitive load, derate current by 20%.

	SYMBOLS	MBR2050CT	MBR2060CT	UNITS
Maximum Recurrent Peak Reverse Voltage	V_{RRM}	50	60	Volts
Working Peak Reverse Voltage	V_{RM}	50	60	Volts
Maximum DC Blocking Voltage	V_{DC}	50	60	Volts
Maximum Average Forward Rectified Current See Fig.1	$I_{(AV)}$	20		Amps
Peak Forward Surge Current 8.3ms single half sine-wave superimposed on rated load (JEDEC Method)	I_{FSM}	150		Amps
Peak Repetitive Reverse Surge Current (Note 3)	I_{RRM}	1.0		Amps
Maximum Forward Voltage Per Leg (Note 2)	V_F	0.70 0.85 0.95		Volts
		$I_F = 10A, T_C = 125^\circ C$		
		$I_F = 20A, T_C = 125^\circ C$		
		$I_F = 20A, T_C = 25^\circ C$		
Maximum Instantaneous Reverse Current at Rated DC Blocking Voltage per element $T_C = 125^\circ C$	I_R	15		mA
Maximum Instantaneous Reverse Current at Rated DC Blocking Voltage $T_C = 25^\circ C$	I_R	0.1		mA
Voltage Rate of Change, (Rated V_R)	dv/dt	1000		$V/\mu s$
Typical Thermal Resistance (Note 1)	$R_{\theta JC}$	2.0		$^\circ C/W$
Maximum Operating Junction Temperature	T_J	-65 to +150		$^\circ C$
Maximum Storage Temperature	T_{STG}	-65 to +175		$^\circ C$

NOTES: 1. Thermal Resistance to CASE.
2. 300 μs Pulse Width 300 us, 2% Duty Factor.
3. 2.0 μs , 1KHz.

RATINGS AND CHARACTERISTIC CURVES MBR2035CT AND MBR2045CT

FIG. 1 — FORWARD CURRENT DERATING CURVE

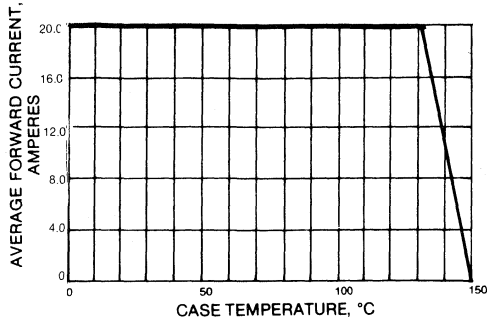

FIG. 3 — MAXIMUM NON-REPETITIVE SURGE CURRENT

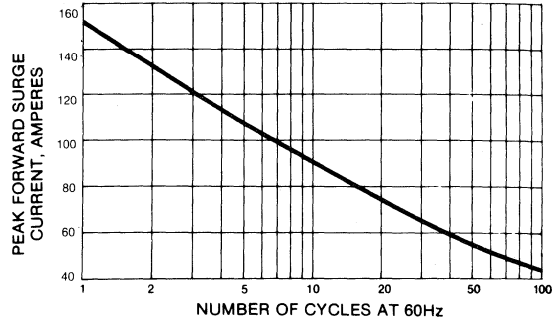

FIG. 2 — MAXIMUM REVERSE CHARACTERISTICS

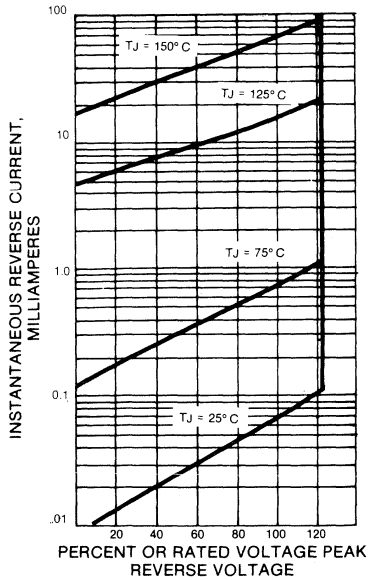

FIG. 4 — TYPICAL INSTANTANEOUS FORWARD CHARACTERISTICS

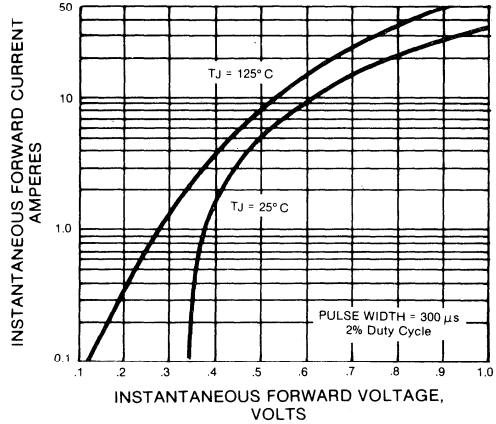
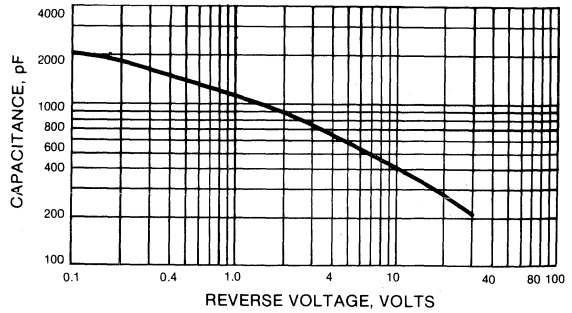
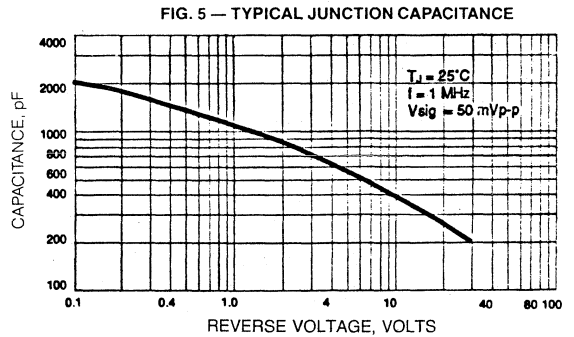
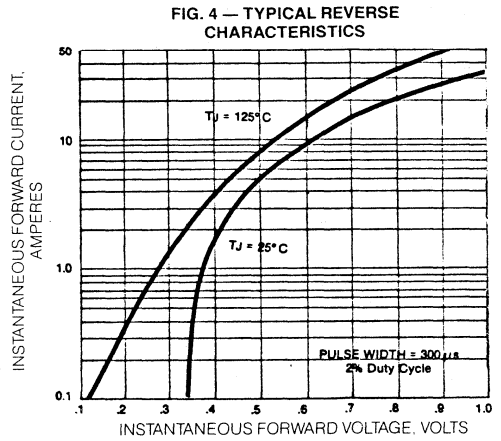
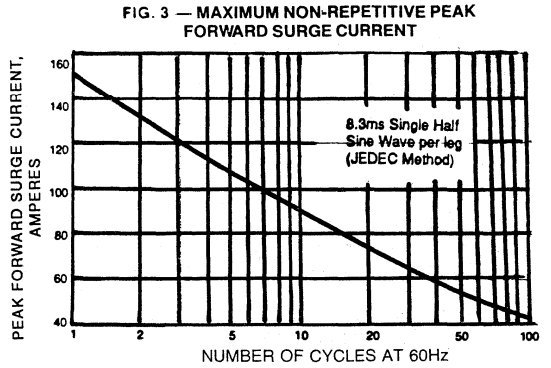
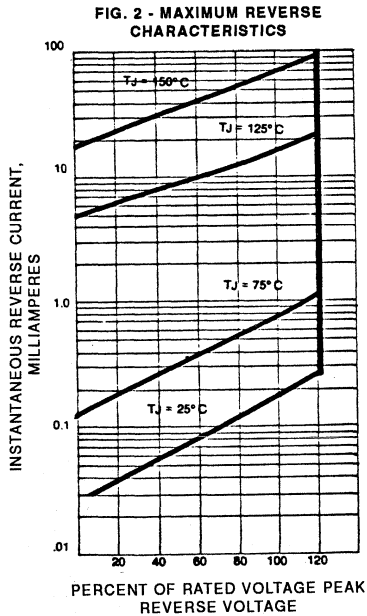
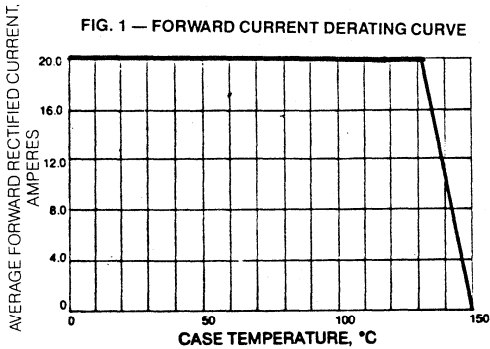

FIG. 5 — TYPICAL JUNCTION CAPACITANCE



**GENERAL
INSTRUMENT**

RATINGS AND CHARACTERISTIC CURVES MBR2050CT AND MBR2060CT



**GENERAL
INSTRUMENT**

MBR2090CT AND MBR20100CT

SCHOTTKY RECTIFIER

VOLTAGE RANGE -90 and 100 Volts CURRENT - 20 Amperes

FEATURES

- ◆ Plastic package has Underwriters Laboratory Flammability Classifications 94V-O.
- ◆ Metal to silicon rectifier, majority carrier conduction
- ◆ Low power loss, high efficiency
- ◆ High current capability, low VF
- ◆ High surge capacity
- ◆ Epitaxial construction
- ◆ For use in low voltage, high frequency inverters, free wheeling, and polarity protection applications
- ◆ Guard Ring for transient protection

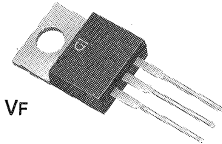

TO-220CT

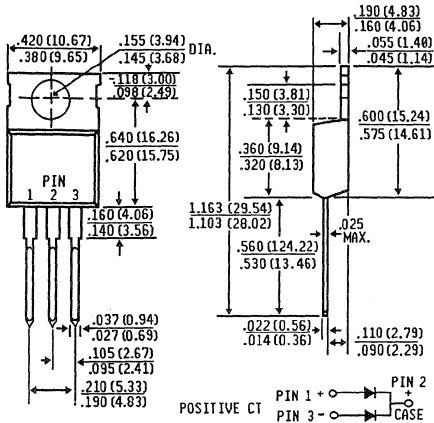

Dimensions in inches and (millimeters)

MECHANICAL DATA

Case: TO-220 Molded Plastic

Terminals: Solderable per MIL-STD- 202, Method 208

Polarity: As marked

Mounting Position: Any

Weight: .08 ounces, 2.24 gram

MAXIMUM RATINGS AND ELECTRICAL CHARACTERISTICS

Ratings at 25°C ambient temperature unless otherwise specified. Resistive or inductive load. For capacitive load, derate current by 20%.

	SYMBOLS	MBR2090CT	MBR20100CT	UNITS
Maximum Recurrent Peak Reverse Voltage	V _{RRM}	90	100	Volts
Working Peak Reverse Voltage	V _{RWM}	90	100	Volts
DC Blocking Voltage	V _{DC}	90	100	Volts
Maximum Average Forward Rectified Current at T _C = 125°C	I _(AV)	20		Amps
Peak Repetitive Forward Current, (Square Wave 20 KHz) at T _C = 125°C	I _{FSM}	40		Amps
Peak Forward Surge Current 8.3ms single half sine-wave superimposed on rated load (JEDEC Method)	I _{FSM}	150		Amps
Peak Repetitive Reverse Surge Current (2.0us, 1KHz)	I _{RSM}	1.0		Amps
Voltage Rate of Change, dv/dt (rated V _R)	V/μs	1000		V/μs
Maximum Forward Voltage (Note 1)				
I _F = 10A, T _C = 25°C		0.80		
I _F = 10A, T _C = 125°C		0.70		
I _F = 20A, T _C = 125°C	V _F	0.85		Volts
I _F = 20A, T _C = 25°C		0.95		
Maximum Instantaneous Reverse Current at Peak Reverse Voltage T _C = 125°C (Note 1)	I _R	150		mA
Peak Reverse Voltage T _C = 25°C	I _R	0.15		mA
Maximum Thermal Resistance, Junction to Case	R _{θJC}	2.0		°C/W
Maximum Operating Junction Temperature	T _C	-65 to +150		°C
Maximum Storage Temperature	T _{STG}	-65 to +175		°C

NOTES: 1. Pulse Test Pulse Width 300 μs, Duty Cycle 2%.

RATINGS AND CHARACTERISTIC CURVES MBR2090CT AND MBR20100CT

FIG. 1 — FORWARD CURRENT DERATING CURVE

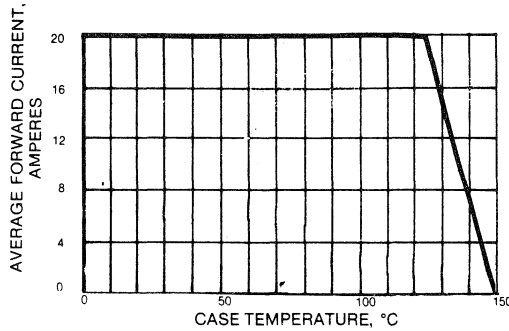

FIG. 2 — TYPICAL REVERSE CHARACTERISTICS

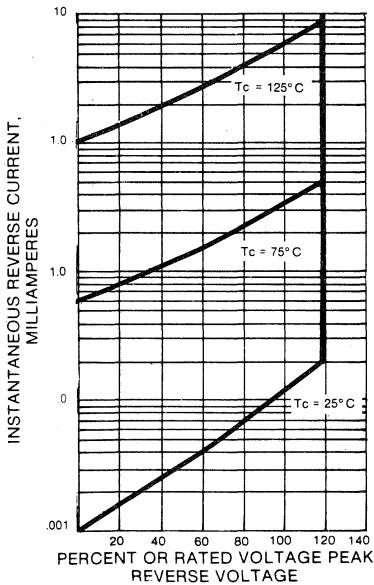

FIG. 3 — MAXIMUM NON-REPETITIVE PEAK FORWARD SURGE CURRENT

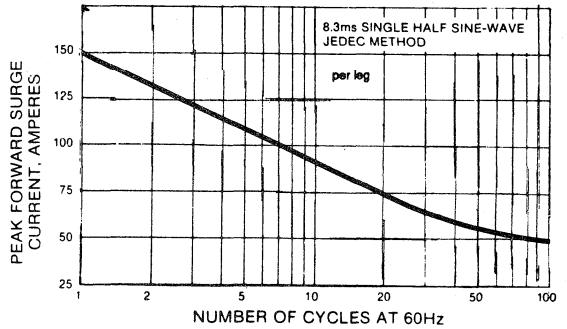

FIG. 4 — TYPICAL INSTANTANEOUS FORWARD CHARACTERISTICS

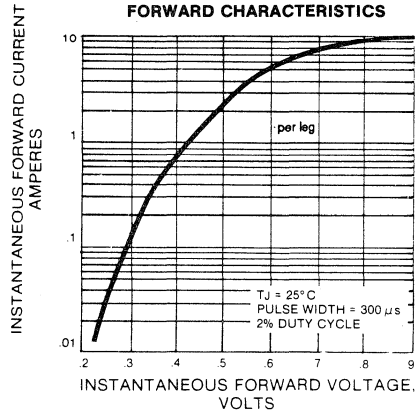
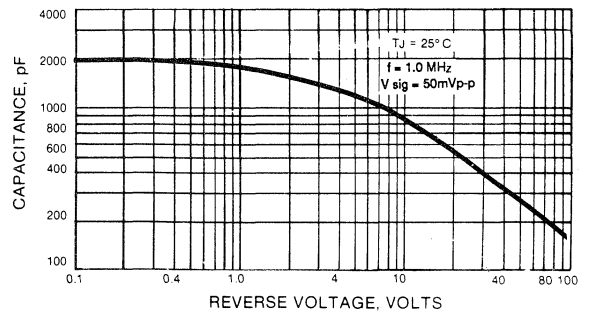

FIG. 5 — TYPICAL JUNCTION CAPACITANCE



**GENERAL
INSTRUMENT**

SBLF2030PT AND SBLF2040PT

SCHOTTKY RECTIFIER

VOLTAGE RANGE - 30 and 40 Volts CURRENT - 20 Amperes

FEATURES

ITO-3P

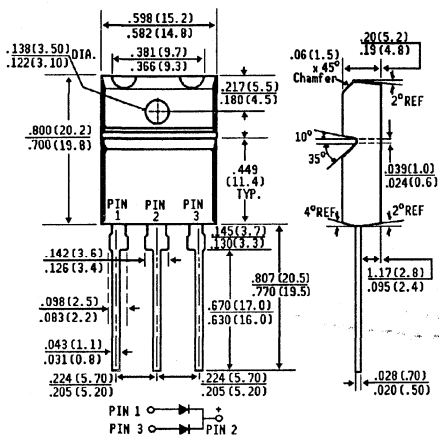

Dimensions in inches
and
(millimeters)

- ◆ Dual rectifier construction, positive center-tap
- ◆ Isolated plastic package has Underwriters Laboratory Flammability Classifications 94V-0
- ◆ Metal to silicon rectifier, majority carrier conduction
- ◆ Low power loss, high efficiency
- ◆ High current capability, low V_F
- ◆ High surge capacity
- ◆ Epitaxial construction
- ◆ For use in low voltage, high frequency inverters, free wheeling, and polarity protection applications
- ◆ High temperature soldering guaranteed: 250°C/10 seconds/.17", (4.3mm) lead lengths at 5 lbs. (2.3kg) tension
- ◆ Internal Insulation: 1.5k VRMS

MECHANICAL DATA

Case: ITO-3P Molded Plastic

Terminals: Lead solderable per MIL-STD-202, Method 208

Polarity: As marked

Mounting Position: Any

Mounting Torque: 5 in. - lb. max.

Weight: .47 ounces, 13.2 grams

MAXIMUM RATINGS AND ELECTRICAL CHARACTERISTICS

Ratings at 25°C ambient temperature unless otherwise specified. Resistive or inductive load. For capacitive or inductive load, derate current by 20%.

	SYMBOLS	SBLF2030PT	SBLF2040PT	UNITS
Maximum Recurrent Peak Reverse Voltage	V_{RRM}	30	40	Volts
Maximum RMS Voltage	V_{RMS}	21	28	Volts
Maximum DC Blocking Voltage	V_{DC}	30	40	Volts
Maximum Average Forward Rectified Current See Fig. 1	$I_{(AV)}$	20.0		Amps
Peak Forward Surge Current, 8.3ms single half sine-wave superimposed on rated load (JEDEC Method)	I_{FSM}	250		Amps
Maximum Instantaneous Forward Voltage Per Leg $I_F = 10.0$, $T_C = 25^\circ C$ (Note 2)	V_F	.55		Volts
Maximum Average Reverse Current at $T_C = 25^\circ C$ Rated DC Blocking Voltage per element $T_C = 100^\circ C$	I_R	50.0		mA
Typical Thermal Resistance (Note 1)	$R_{\theta JC}$	2.0		$^\circ C/W$
Operating and Storage Temperature Range	T_C, T_{STG}	-40 to +125		$^\circ C$

NOTES:

1. Thermal Resistance from Junction to Case per element.
2. 300 us Pulse Width, 2% Duty Factor.

RATINGS AND CHARACTERISTIC CURVES SBLF2030PT AND SBLF2040PT

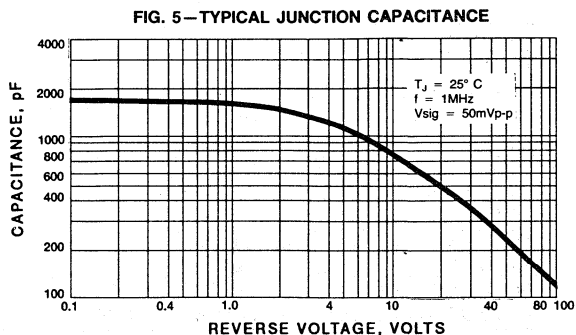
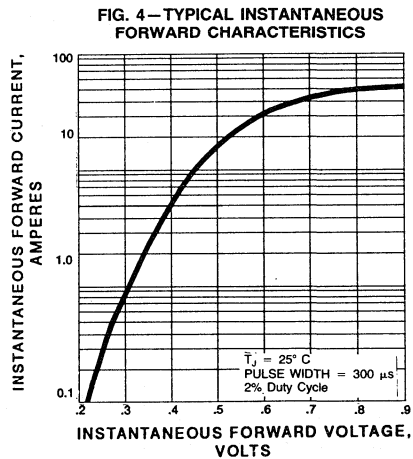
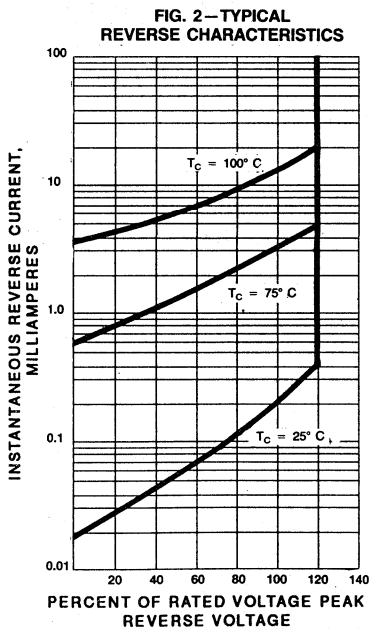
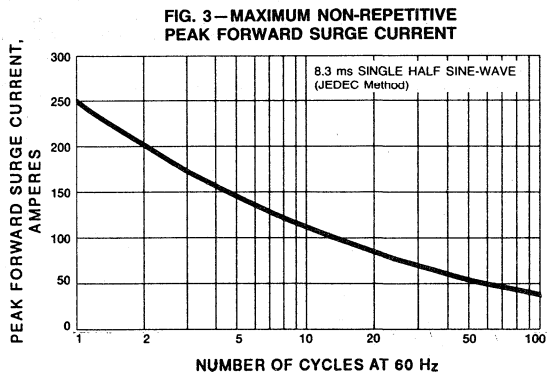
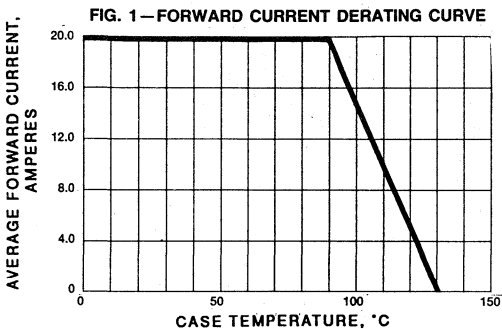

SBL2030PT AND SBL2040PT

SCHOTTKY RECTIFIER

VOLTAGE RANGE - 30 and 40 Volts CURRENT - 20 Amperes

FEATURES

- ◆ Dual rectifier construction, positive center-tap
- ◆ Plastic package has Underwriters Laboratory Flammability Classifications 94V-0
- ◆ Metal to silicon rectifier, majority carrier conduction
- ◆ Low power loss, high efficiency
- ◆ High current capability, low VF
- ◆ High surge capacity
- ◆ Epitaxial construction
- ◆ For use in low voltage, high frequency inverters, free wheeling, and polarity protection applications
- ◆ High temperature soldering guaranteed: 250°C/10 seconds/.17", (4.3mm) lead lengths at 5 lbs. (2.3kg) tension

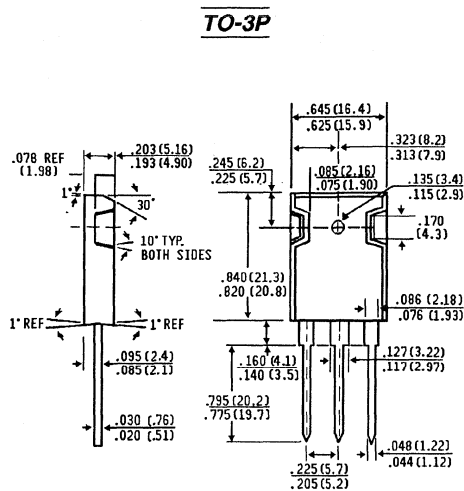
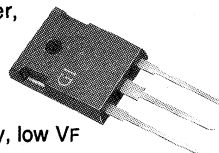

Dimensions in inches
and
(millimeters)

MECHANICAL DATA

Case: TO-3P Molded Plastic
Terminals: Lead solderable per MIL-STD-202, Method 208
Polarity: As marked
Mounting Position: Any
Weight: .2 ounces, 5.6 grams

MAXIMUM RATINGS AND ELECTRICAL CHARACTERISTICS

Ratings at 25°C ambient temperature unless otherwise specified. Resistive or inductive load. For capacitive or inductive load, derate current by 20%.

	SYMBOLS	SBL2030PT	SBL2040PT	UNITS
Maximum Recurrent Peak Reverse Voltage	V _{RRM}	30	40	Volts
Maximum RMS Voltage	V _{RMS}	21	28	Volts
Maximum DC Blocking Voltage	V _{DC}	30	40	Volts
Maximum Average Forward Rectified Current See Fig. 1	I _(AV)	20.0		Amps
Peak Forward Surge Current, 8.3ms single half sine-wave superimposed on rated load (JEDEC Method)	I _{FSM}	250		Amps
Maximum Instantaneous Forward Voltage Per Leg I _F = 8.0, T _C = 25°C (Note 2)	V _F	.55		Volts
Maximum Average Reverse Current at T _C = 25°C	I _R	1.0		mA
Rated DC Blocking Voltage per element T _C = 100°C	I _R	50.0		mA
Typical Thermal Resistance (Note 1)	R _{θJC}	1.5		°C/W
Operating and Storage Temperature Range	T _C , T _{STG}	-40 to +125		°C

NOTES:

1. Thermal Resistance from Junction to Case.
2. 300 us Pulse Width, 2% Duty Factor.

RATINGS AND CHARACTERISTIC CURVES SBL2030PT AND SBL2040PT

FIG. 1 — FORWARD CURRENT DERATING CURVE

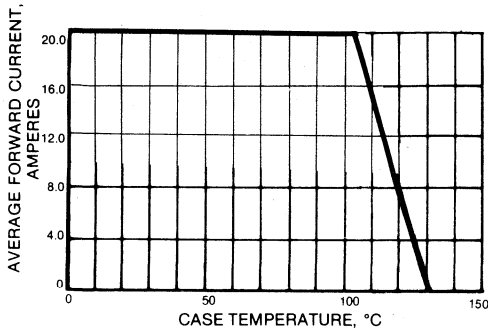

FIG. 2 — TYPICAL REVERSE CHARACTERISTICS

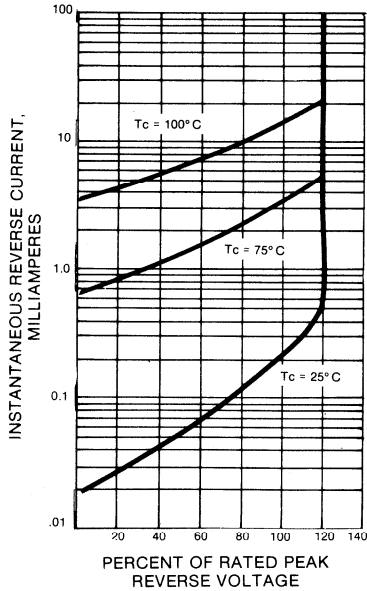

FIG. 3 — MAXIMUM NON-REPETITIVE PEAK FORWARD SURGE CURRENT

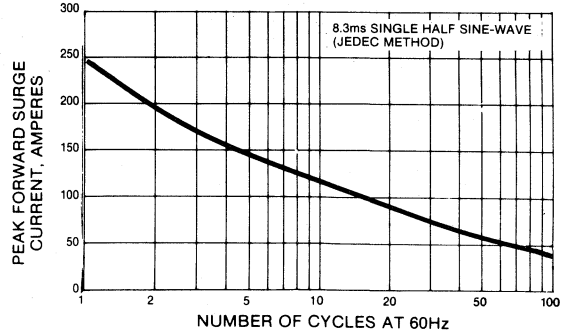

FIG. 4 — TYPICAL FORWARD CHARACTERISTICS

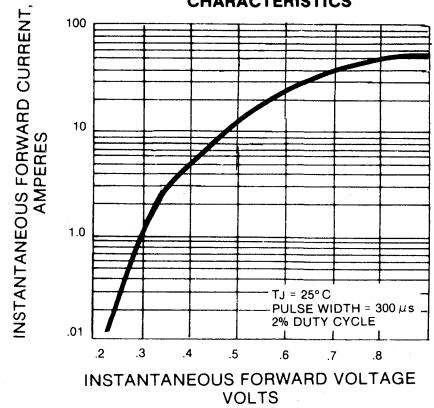
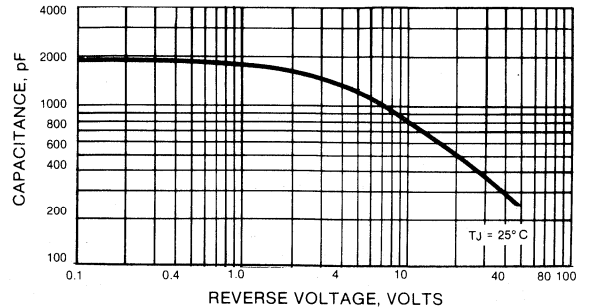

FIG. 5 — TYPICAL JUNCTION CAPACITANCE



MBRF2535CT AND MBRF2545CT

SCHOTTKY RECTIFIER

VOLTAGE RANGE - 35 and 45 Volts CURRENT - 30 Amperes

FEATURES

- ◆ Isolated plastic package has Underwriters Laboratory Flammability Classifications 94V-O.
- ◆ Metal to silicon rectifier, majority carrier conduction
- ◆ Low power loss, high efficiency
- ◆ High current capability, low VF
- ◆ High surge capacity
- ◆ Epitaxial construction
- ◆ For use in low voltage, high frequency inverters, free wheeling, and polarity protection applications
- ◆ High temperature soldering guaranteed: 250°C/10 seconds/.25", (6.35mm) from case
- ◆ Guard Ring for transient protection
- ◆ Internal Insulation: 1.5k VRms

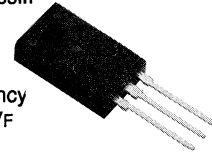

ITO-220 CT

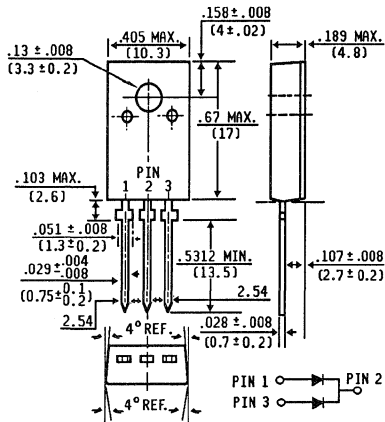

Dimensions in inches and (millimeters)

MECHANICAL DATA

Case: ITO-220 Molded Plastic

Terminals: Leads, solderable per MIL-STD- 202, Method 208

Polarity: As marked

Mounting Position: Any

Mounting Torque: 5 in. - lb. max.

Weight: .08 ounces, 2.24 grams

MAXIMUM RATINGS AND ELECTRICAL CHARACTERISTICS

Ratings at 25°C ambient temperature unless otherwise specified. Resistive or inductive load. For capacitive load, derate current by 20%.

	SYMBOLS	MBRF2535CT	MBRF2545CT	UNITS
Maximum Recurrent Peak Reverse Voltage	V _{RRM}	35	45	Volts
Working Peak Reverse Voltage	V _{RWM}	24.5	31.5	Volts
Maximum DC Blocking Voltage	V _{DC}	35	45	Volts
Maximum Average Forward Rectified Current see Fig. 1	I _(AV)	30		Amps
Peak Forward Surge Current 8.3ms single half sine-wave superimposed on rated load (JEDEC Method)	I _{FSM}	150		Amps
Peak Repetitive Reverse Surge Current (Note 3)	I _{RRM}	1.0		Amps
Maximum Forward Voltage Per Leg I _F = 30A, T _C = 125°C (Note 2) I _F = 30A, T _C = 25°C	V _F	0.73 0.82		Volts
Maximum Instantaneous Reverse Current at Rated DC Blocking Voltage (Note 2) T _C = 125°C	I _R	40		mA
Maximum Instantaneous Reverse Current at Rated DC Blocking Voltage T _C = 25°C	I _R	0.2		mA
Typical Thermal Resistance, (Note 1)	R _{θJC}	1.8		°C/W
Voltage Rate of Change, (Rated V _R)	dv/dt	1000		V/us
Maximum Operating Junction Temperature	T _C	-65 to + 150		°C
Maximum Storage Temperature	T _{STG}	-65 to +175		°C

NOTES: 1. Thermal Resistance Junction to CASE per element.
2. 300 μs Pulse Width, 2%, Duty Factor
3. 2.0μs, 1KHz.

RATINGS AND CHARACTERISTIC CURVES MBRF2535CT AND MBRF2545CT

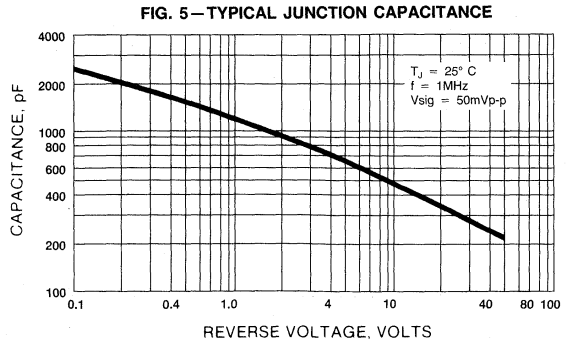
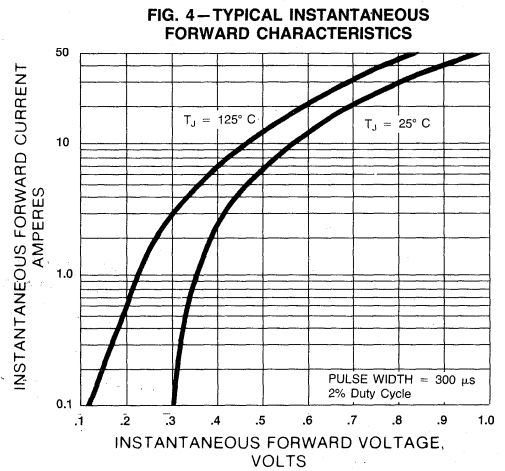
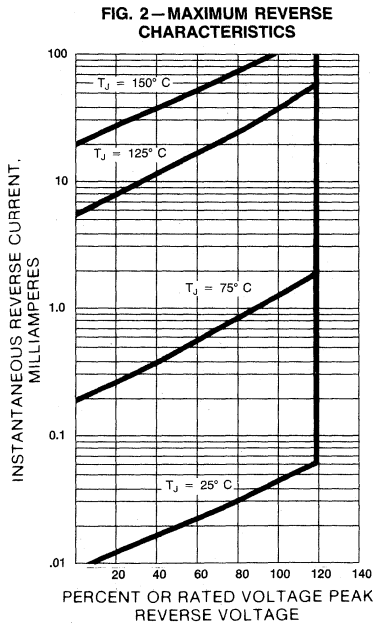
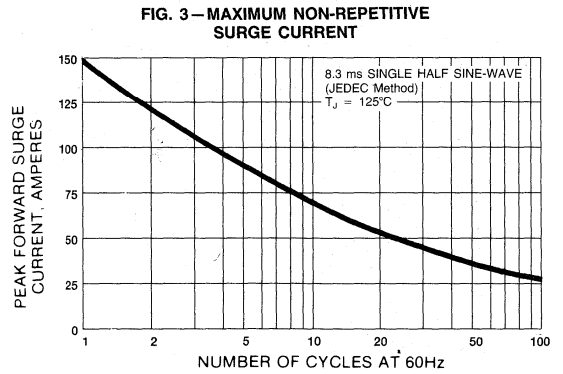
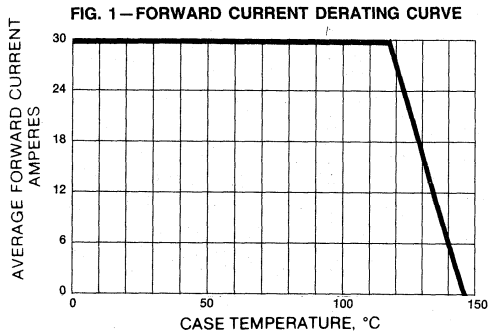

MBRF2550CT AND MBRF2560CT

SCHOTTKY RECTIFIER

VOLTAGE RANGE - 50 and 60 Volts CURRENT - 30 Amperes

FEATURES

- ◆ Isolated plastic package has Underwriters Laboratory Flammability/Classifications 94V-0
- ◆ Metal to silicon rectifier, majority carrier conduction
- ◆ Low power loss, high efficiency
- ◆ High current capability, low VF
- ◆ High surge capacity
- ◆ Epitaxial construction
- ◆ For use in low voltage, high frequency inverters, free wheeling, and polarity protection applications
- ◆ High temperature soldering guaranteed: 250°C/10 seconds/.25", (6.35mm) from case
- ◆ Guard Ring for transient protection
- ◆ Internal Insulation: 1.5K VRMS

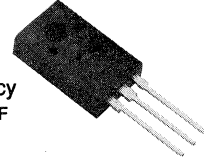

ITO-220 CT

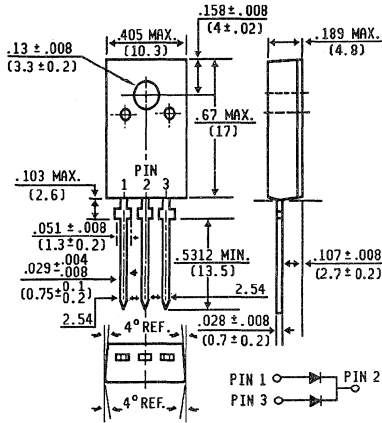

Dimensions in inches
and
(millimeters)

MECHANICAL DATA

Case: ITO-220 Molded Plastic

Terminals: Leads, solderable per MIL-STD- 202, Method 208

Polarity: As marked

Mounting Position: Any

Mounting Torque: 5in. - lb. max.

Weight: .08 ounces, 2.24 grams

MAXIMUM RATINGS AND ELECTRICAL CHARACTERISTICS

Ratings at 25°C ambient temperature unless otherwise specified. Resistive or inductive load. For capacitive load, derate current by 20%.

	SYMBOLS	MBRF2550CT	MBRF2560CT	UNITS
Maximum Recurrent Peak Reverse Voltage	V _{RRM}	50	45	Volts
Working Peak Reverse Voltage	V _{RMS}	35	42	Volts
Maximum DC Blocking Voltage	V _{DC}	60	60	Volts
Maximum Average Forward Rectified Current see Fig. 1	I _(AV)	30.0		Amps
Peak Forward Surge Current 8.3ms single half sine-wave superimposed on rated load (JEDEC Method)	I _{FSM}	150		Amps
Peak Repetitive Reverse Surge Current (Note 3)	I _{RRM}	1.0		Amps
Maximum Forward Voltage Per Leg I _F = 15.0A, T _C = 125°C (Note 2) I _F = 15.0A, T _C = 25°C	V _F	.65	.75	Volts
Maximum Instantaneous Reverse Current at Rated DC Blocking Voltage (Note 2) T _C = 125°C	I _R	50.0		mA
Maximum Instantaneous Reverse Current at Rated DC Blocking Voltage T _C = 25°C	I _R	1.0		mA
Typical Thermal Resistance, (Note 1)	R _{θJC}	1.8		°C/W
Voltage Rate of Change, (Rated V _R)	dv/dt	1000		V/us
Maximum Operating Junction Temperature	T _C	-65 to + 150		°C
Maximum Storage Temperature	T _{STG}	-65 to +175		°C

NOTES: 1. Thermal Resistance Junction to Case per element. 2. 300 μs Pulse Width, 2%, Duty Factor 3. 2.0 μs, 1KHz.

RATINGS AND CHARACTERISTIC CURVES MBRF2550CT AND MBRF2560CT

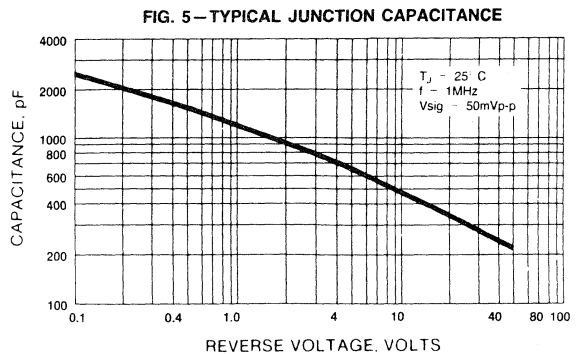
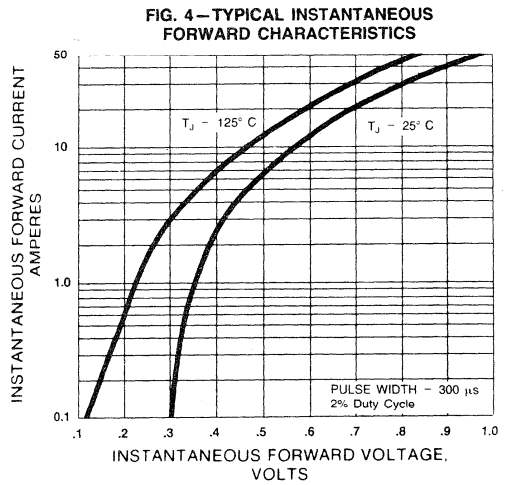
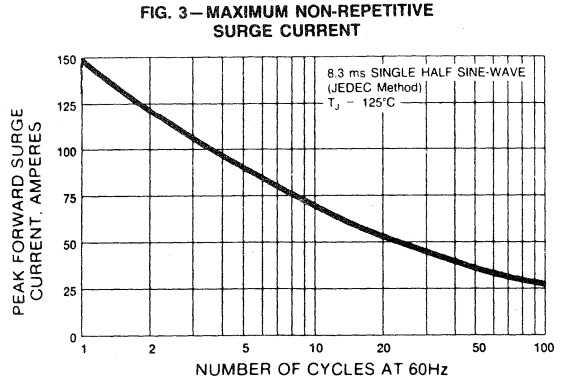
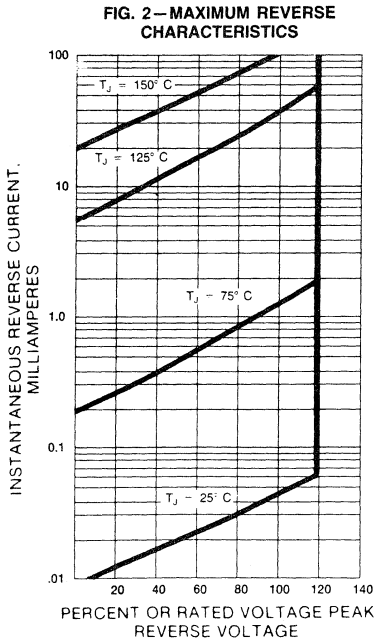
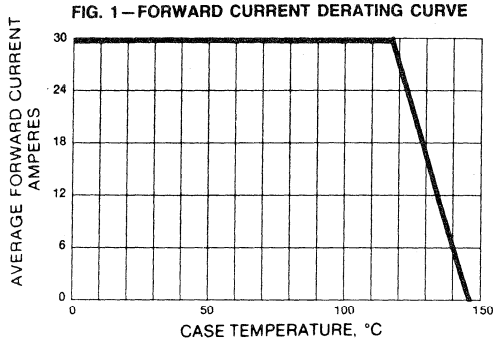

**GENERAL
INSTRUMENT**

MBR2535CT AND MBR2545CT

SCHOTTKY RECTIFIER

VOLTAGE RANGE - 35 and 45 Volts CURRENT - 30 Amperes

FEATURES

- ◆ Plastic package has Underwriters Laboratory Flammability Classifications 94V-O
- ◆ Metal to silicon rectifier, majority carrier conduction
- ◆ Low power loss, high efficiency
- ◆ High current capability, low V_F
- ◆ High surge capacity
- ◆ Epitaxial construction
- ◆ For use in low voltage, high frequency inverters, free wheeling, and polarity protection applications
- ◆ High temperature soldering guaranteed: 250°C/10 seconds/.25", (6.35mm) from case
- ◆ Guard Ring for transient protection

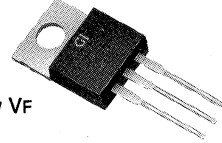

TO-220 CT

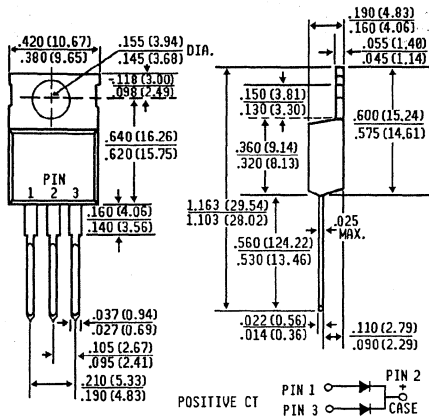

Dimensions in inches and (millimeters)

MECHANICAL DATA

Case: TO-220 Molded Plastic

Terminals: Leads, solderable per MIL-STD- 202, Method 208

Polarity: As marked

Mounting Position: Any

Weight: .08 ounces, 2.24 gram

MAXIMUM RATINGS AND ELECTRICAL CHARACTERISTICS

Ratings at 25°C ambient temperature unless otherwise specified. Resistive or inductive load. For capacitive load, derate current by 20%.

	SYMBOLS	MBR2535CT	MBR2545CT	UNITS
Maximum Recurrent Peak Reverse Voltage	V_{RRM}	35	45	Volts
Working Peak Reverse Voltage	V_{RWM}	24.5	31.5	Volts
Maximum DC Blocking Voltage	V_{DC}	35	45	Volts
Maximum Average Forward Rectified Current see Fig. 1	$I_{(AV)}$	30		Amps
Peak Forward Surge Current 8.3ms single half sine-wave superimposed on rated load (JEDEC Method)	I_{FSM}	150		Amps
Peak Repetitive Reverse Surge Current (Note 3)	I_{RRM}	1.0		Amps
Maximum Forward Voltage Per Leg $I_F = 30A, T_C = 125^\circ C$ (Note 2) $I_F = 30A, T_C = 25^\circ C$	V_F	0.73	0.82	Volts
Maximum Instantaneous Reverse Current at Rated DC Blocking Voltage(Note 2) $T_C = 125^\circ C$	I_R	40		mA
Maximum Instantaneous Reverse Current at Rated DC Blocking Voltage $T_C = 25^\circ C$	I_R	0.2		mA
Typical Thermal Resistance, (Note 1)	$R_{\theta JC}$	1.5		$^\circ C/W$
Voltage Rate of Change, (Rated V_R)	dv/dt	1000		V/us
Maximum Operating Junction Temperature	T_C	-65 to + 150		$^\circ C$
Maximum Storage Temperature	T_{STG}	-65 to +175		$^\circ C$

NOTES:

1. Thermal Resistance Junction to CASE.
2. 300 us Pulse Width, 2%, Duty Factor
3. 2.0us, 1KHz.

RATINGS AND CHARACTERISTIC CURVES MBR2535CT AND MBR2545CT

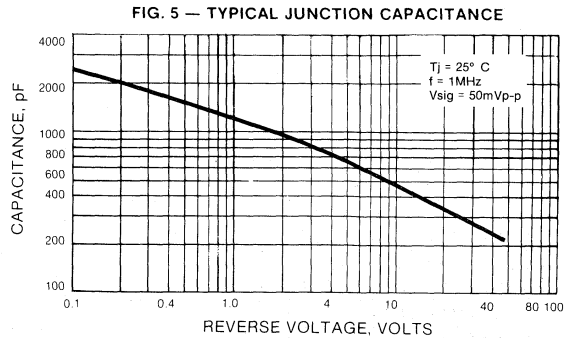
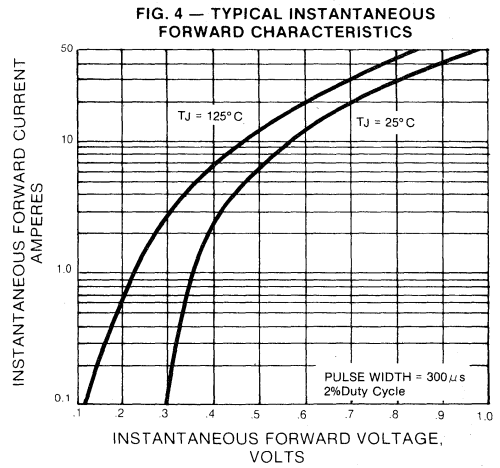
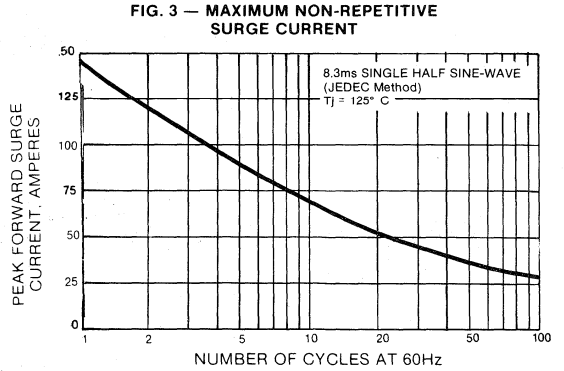
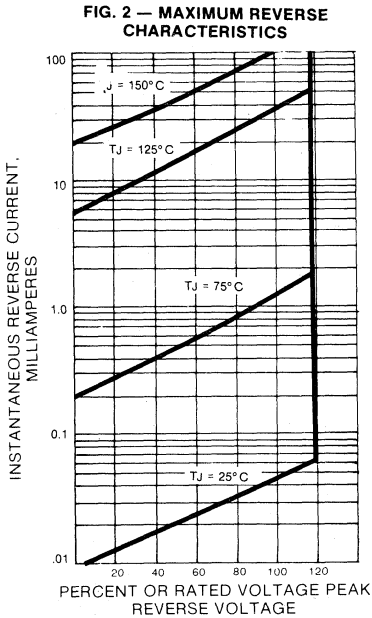
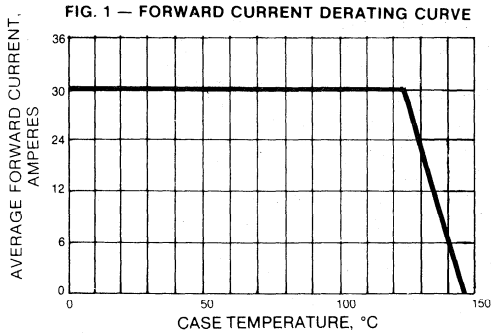

MBR2050CT AND MBR2060CT

SCHOTTKY RECTIFIER

VOLTAGE RANGE - 50 and 60 Volts CURRENT - 20 Amperes

FEATURES

- ◆ Plastic package has Underwriters Laboratory Flammability Classification 94 V-O
- ◆ Metal to silicon rectifier, majority carrier conduction
- ◆ Low power loss, high efficiency
- ◆ High current capability, low VF
- ◆ High surge capacity
- ◆ Epitaxial construction
- ◆ For use in low voltage, high frequency inverters, free wheeling, and polarity protection applications
- ◆ High temperature soldering guaranteed: 250°C/10 seconds/.25", (6.35mm) from case
- ◆ Guard Ring for transient protection

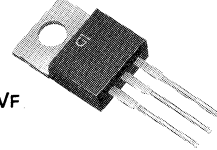

TO-220 CT

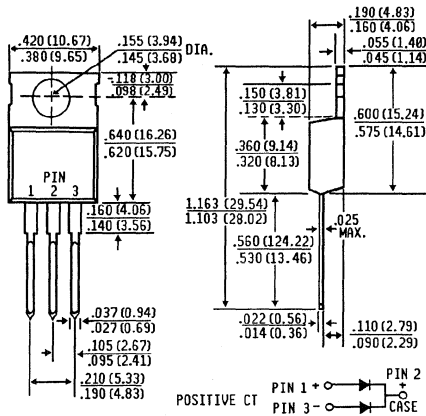

Dimensions in inches
and

MECHANICAL DATA

Case: TO-220 Molded Plastic

Terminals: Leads, solderable per MIL-STD-202, Method 208

Polarity: As marked

Mounting Position: Any

Weight: .08 ounces, 2.24 gram

MAXIMUM RATINGS AND ELECTRICAL CHARACTERISTICS

Ratings at 25°C ambient temperature unless otherwise specified. Resistive or inductive load. For capacitive load, derate current by 20%.

	SYMBOLS	MBR2050CT	MBR2060CT	UNITS
Maximum Recurrent Peak Reverse Voltage	V_{RRM}	50	60	Volts
Working Peak Reverse Voltage	V_{RM}	50	60	Volts
Maximum DC Blocking Voltage	V_{DC}	50	60	Volts
Maximum Average Forward Rectified Current See Fig. 1	$I_{(AV)}$	20		Amps
Peak Forward Surge Current 8.3ms single half sine-wave superimposed on rated load (JEDEC Method)	I_{FSM}	150		Amps
Peak Repetitive Reverse Surge Current (Note 3)	I_{RRM}	1.0		Amps
Maximum Forward Voltage Per Leg (Note 2)	V_F			Volts
		$I_F = 10A, T_C = 125^\circ C$	0.70	
		$I_F = 20A, T_C = 125^\circ C$	0.85	
		$I_F = 20A, T_C = 25^\circ C$	0.95	
Maximum Instantaneous Reverse Current at Rated DC Blocking Voltage per element $T_C = 125^\circ C$	I_R	15		mA
Maximum Instantaneous Reverse Current at Rated DC Blocking Voltage $T_C = 25^\circ C$	I_R	0.1		mA
Voltage Rate of Change, (Rated V_R)	dv/dt	1000		$V_{\mu s}$
Typical Thermal Resistance (Note 1)	$R_{\theta JC}$	2.0		$^\circ C/W$
Maximum Operating Junction Temperature	T_J	-65 to +150		$^\circ C$
Maximum Storage Temperature	T_{STG}	-65 to +175		$^\circ C$

NOTES: 1. Thermal Resistance to Case.
2. 300 μs Pulse Width 300 μs , 2% Duty Factor.
3. 2.0 μs , 1KHz.

RATINGS AND CHARACTERISTIC CURVES MBR2050CT AND MBR2060CT

FIG. 1 — FORWARD CURRENT DERATING CURVE

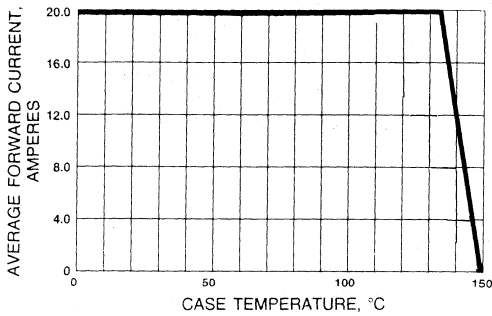

FIG. 2 — MAXIMUM REVERSE CHARACTERISTICS

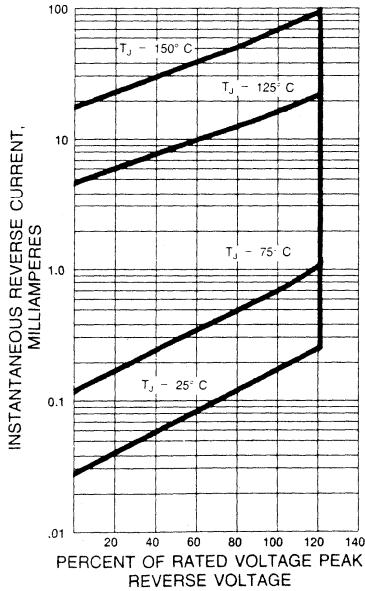

FIG. 3 — MAXIMUM NON-REPETITIVE PEAK FORWARD SURGE CURRENT

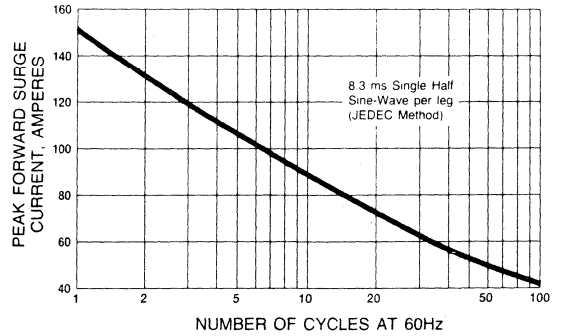

FIG. 4 — TYPICAL INSTANTANEOUS FORWARD CHARACTERISTICS

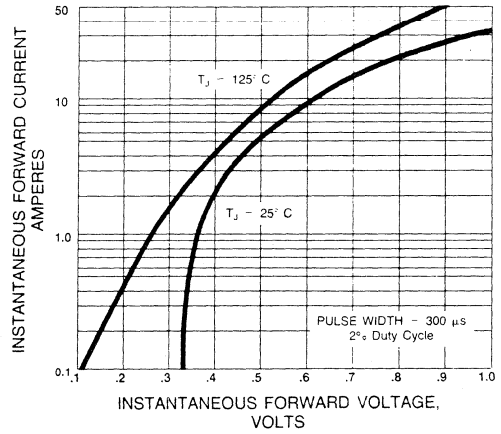
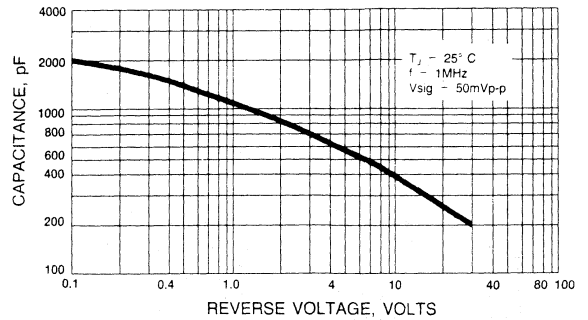

FIG. 5 — TYPICAL JUNCTION CAPACITANCE



**GENERAL
INSTRUMENT**

MBRF3035PT AND MBRF3045PT

SCHOTTKY RECTIFIER
VOLTAGE RANGE - 35 and 45 Volts CURRENT - 30 Amperes

FEATURES

- ◆ Dual rectifier construction, positive center-tap
- ◆ Isolated plastic package has Underwriters Laboratory Flammability Classifications 94V-0
- ◆ Metal to silicon rectifier, majority carrier conduction
- ◆ Low power loss, high efficiency
- ◆ High current capability, low V_f
- ◆ High surge capacity
- ◆ Epitaxial construction
- ◆ For use in low voltage, high frequency inverters, free wheeling, and polarity protection applications
- ◆ High temperature soldering guaranteed: 250°C, .17 (4.3mm) lead length at 5 lbs. (2.3kg) tension
- ◆ Guard Ring for transient protection
- ◆ Internal Insulation: 1.5k VRMS

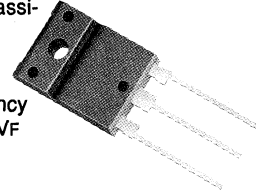

ITO-3P

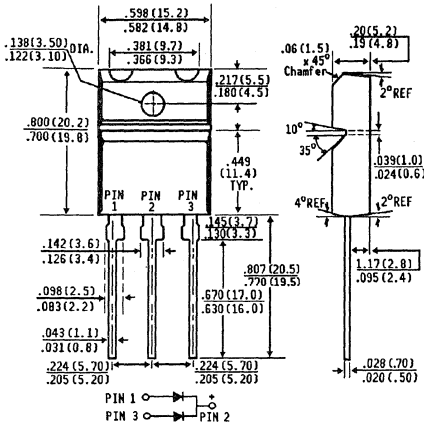

Dimensions in inches and (millimeters)

MECHANICAL DATA

Case: ITO-3P Molded Plastic

Terminals: Lead solderable per MIL-STD-202, Method 208

Polarity: As marked

Mounting Position: Any

Mounting Torque: 5 in. - lb. max.

Weight: .47 ounces, 13.2 grams

MAXIMUM RATINGS AND ELECTRICAL CHARACTERISTICS

Ratings at 25°C ambient temperature unless otherwise specified. Resistive or inductive load. For capacitive load, derate current by 20%.

	SYMBOLS	MBRF3035PT	MBRF3045PT	UNITS
Maximum Recurrent Peak Reverse Voltage	V_{RRM}	35	45	Volts
Maximum RMS Voltage	V_{RMS}	25	32	Volts
Maximum DC Blocking Voltage	V_{DC}	35	45	Volts
Maximum Average Forward Rectified Current (see Fig. 1)	$I_{(AV)}$	30		Amps
Peak Forward Surge Current, 8.3ms single half sine-wave superimposed on rated load (JEDEC Method)	I_{FSM}	200		Amps
Peak Repetitive Reverse Surge Current (Note 3)	I_{RSM}	2.0		Amps
Maximum Instantaneous Forward Voltage Per Leg	V_f	$I_f = 20A, T_c = 125^\circ C$ (Note 2)	0.60	Volts
		$I_f = 30A, T_c = 125^\circ C$	0.72	
		$I_f = 30A, T_c = 25^\circ C$	0.76	
Maximum Instantaneous Reverse Current at Rated DC Blocking Voltage per element	I_R	1.0		mA
		60		
Maximum Thermal Resistance (Note 1)	$R_{\theta JC}$	1.7		°C/W
Voltage Rate of Change, (Rated V_R)	dv/dt	1000		V/us
Maximum Operating Temperature Range	T_c	-65 to +150		°C
Maximum Storage Temperature Range	T_{STG}	-65 to +175		°C

NOTES: 1. Thermal Resistance from Junction to Case per element.

2. 300 μs Pulse Width, 2% Duty Factor.

RATINGS AND CHARACTERISTIC CURVES MBRF3035PT AND MBRF3045PT

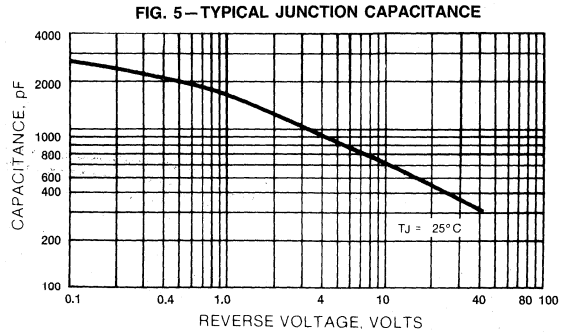
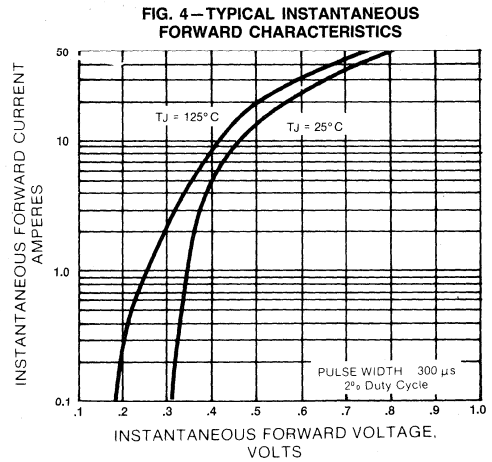
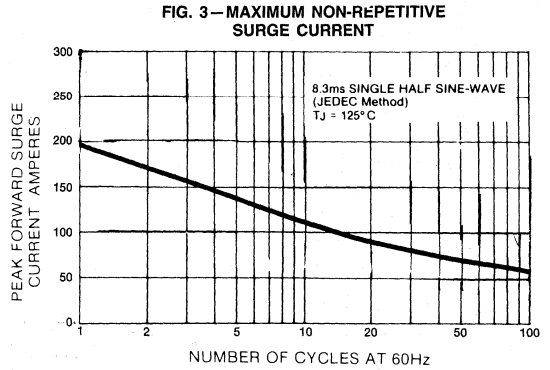
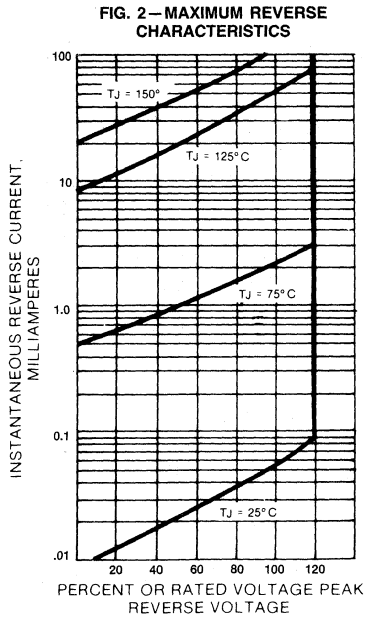
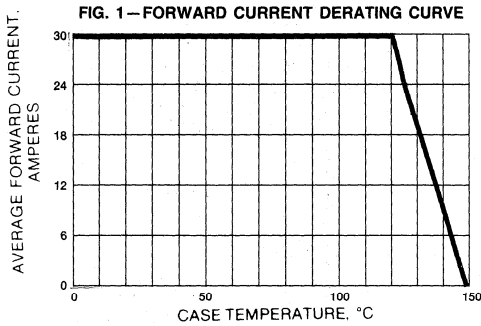

GENERAL INSTRUMENT

MBRF3050PT AND MBRF3060PT

SCHOTTKY RECTIFIER
VOLTAGE RANGE - 50 and 60 Volts CURRENT - 30 Amperes

FEATURES

- ◆ Dual rectifier construction, positive center-tap
- ◆ Isolated plastic package has Underwriters Laboratory Flammability Classifications 94V-O
- ◆ Metal to silicon rectifier, majority carrier conduction
- ◆ Low power loss, high efficiency
- ◆ High current capability, low VF
- ◆ High surge capacity
- ◆ Epitaxial construction
- ◆ For use in low voltage, high frequency inverters, free wheeling, and polarity protection applications
- ◆ High temperature soldering guaranteed: 250°C, .17 (4.3mm) lead length at 5 lbs. (2.3kg) tension
- ◆ Guard Ring for transient protection
- ◆ Internal Insulation: 1.5k VRMS

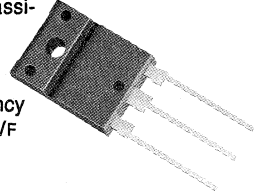

ITO-3P

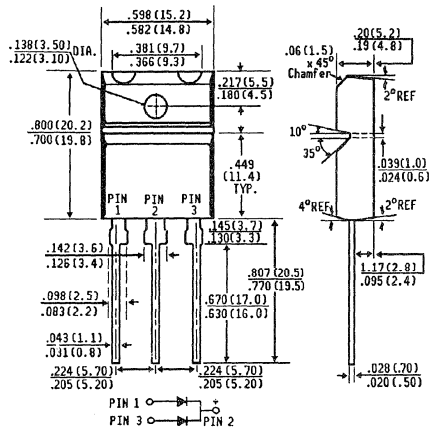

Dimensions in inches and (millimeters)

MECHANICAL DATA

Case: ITO-3P Molded Plastic

Terminals: Lead solderable per MIL-STD-202, Method 208

Polarity: As marked

Mounting Position: Any

Mounting Torque: 5 lb. - in. max.

Weight: .47 ounces, 13.2 grams

MAXIMUM RATINGS AND ELECTRICAL CHARACTERISTICS

Ratings at 25°C ambient temperature unless otherwise specified. Resistive or inductive load. For capacitive or inductive load, derate current by 20%.

	SYMBOLS	MBRF3050PT	MBRF3060PT	UNITS
Maximum Recurrent Peak Reverse Voltage	V_{RRM}	50	60	Volts
Maximum RMS Voltage	V_{RMS}	35	42	Volts
Maximum DC Blocking Voltage	V_{DC}	50	60	Volts
Maximum Average Forward Rectified Current (see Fig. 1)	$I_{(AV)}$	30		Amps
Peak Forward Surge Current, 8.3ms single half sine-wave superimposed on rated load (JEDEC Method)	I_{FSM}	300		Amps
Peak Repetitive Reverse Surge Current (Note 3)	I_{RSM}	2.0		Amps
Maximum Instantaneous Forward Voltage Per Leg $I_F = 15A, T_C = 125^\circ C$ $I_F = 15A, T_C = 25^\circ C$	V_F	.65	.75	Volts
Maximum Instantaneous Reverse Current at Rated DC Blocking Voltage per element $T_C = 25^\circ C$ $T_C = 125^\circ C$	I_R	5.0	100	mA
Maximum Thermal Resistance (Note 1)	$R_{\theta JC}$	1.7		$^\circ C/W$
Voltage Rate of Change, (Rated V_R)	dv/dt	1000		V/us
Maximum Operating Temperature Range	T_C	-65 to +150		$^\circ C$
Maximum Storage Temperature Range	T_{STG}	-65 to +175		$^\circ C$

NOTES: 1. Thermal Resistance from Junction to Case per element.

2. 300 μs Pulse Width, 2% Duty Factor.

RATINGS AND CHARACTERISTIC CURVES MBRF3050PT AND MBRF3060PT

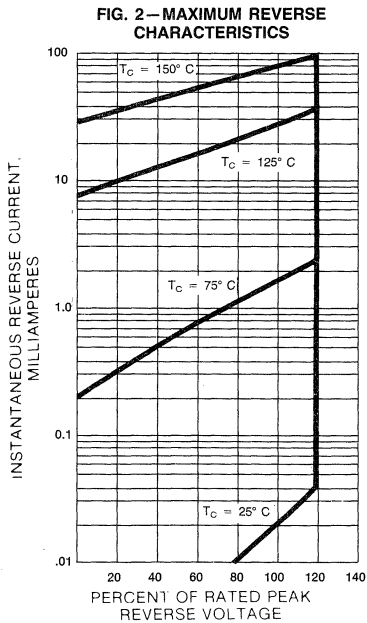
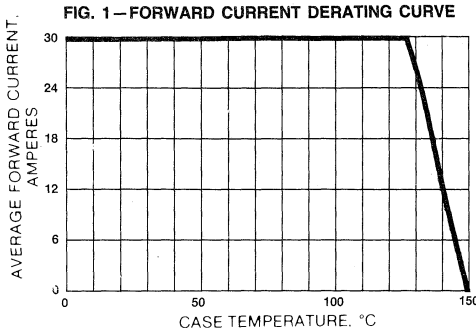

FIG. 3—MAXIMUM NON-REPETITIVE SURGE CURRENT

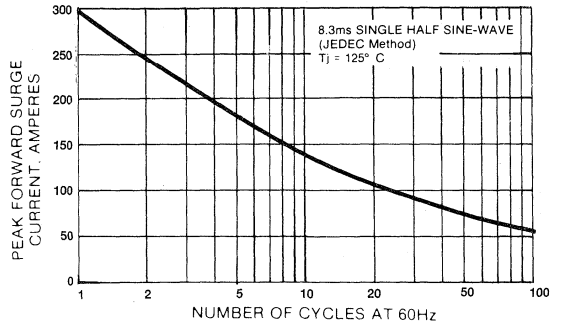

FIG. 4—TYPICAL INSTANTANEOUS FORWARD CHARACTERISTICS PER ELEMENT

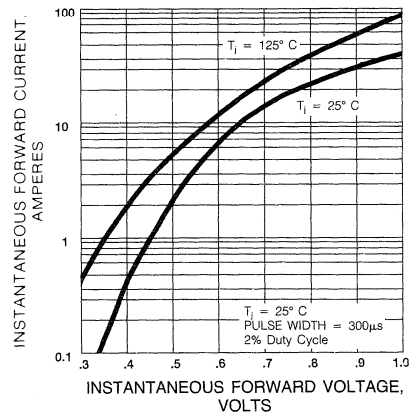
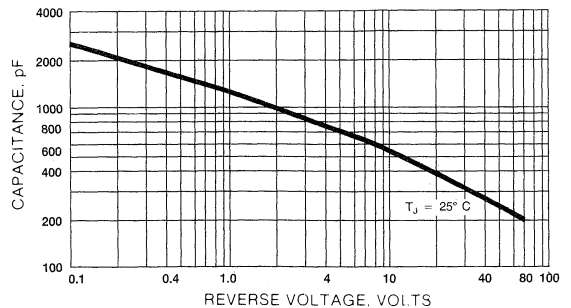

FIG. 5—TYPICAL JUNCTION CAPACITANCE PER ELEMENT



GENERAL INSTRUMENT

MBR3035PT AND MBR3045PT

SCHOTTKY RECTIFIER

VOLTAGE RANGE - 35 and 45 Volts CURRENT - 30 Amperes

FEATURES

- ◆ Dual rectifier construction, positive center-tap
- ◆ Plastic package has Underwriters Laboratory Flammability Classifications 94V-0
- ◆ Metal to silicon rectifier, majority carrier conduction
- ◆ Low power loss, high efficiency
- ◆ High current capability, low VF
- ◆ High surge capacity
- ◆ Epitaxial construction
- ◆ For use in low voltage, high frequency inverters, free wheeling, and polarity protection applications
- ◆ High temperature soldering guaranteed: 250°C, .17 (4.3mm) lead length at 5 lbs. (2.3kg) tension
- ◆ Guard Ring for transient protection

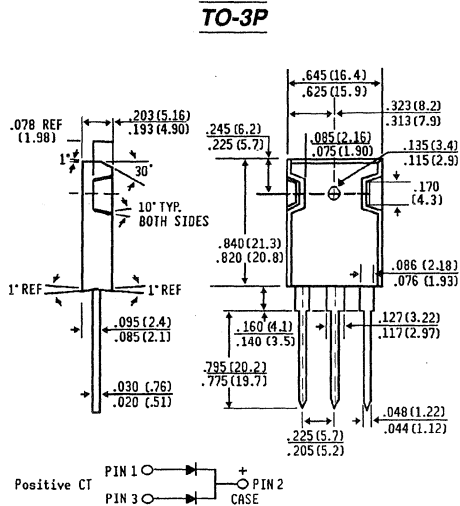
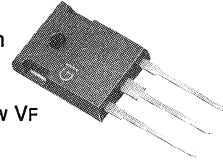

Dimensions in inches and (millimeters)

MECHANICAL DATA

Case: TO3P Molded Plastic

Terminals: Lead solderable per MIL-STD-202 Method 208

Polarity: As marked

Mounting Position: Any

Weight: .2 ounces, 5.6 gram

MAXIMUM RATINGS AND ELECTRICAL CHARACTERISTICS

Ratings at 25°C ambient temperature unless otherwise specified. Resistive or inductive load. For capacitive or inductive load, derate current by 20%

	SYMBOLS	MBR3035PT	MBR3045PT	UNITS
Maximum Recurrent Peak Reverse Voltage	V _{RRM}	35	45	Volts
Maximum RMS Voltage	V _{RMS}	24.5	31.5	Volts
Maximum DC Blocking Voltage	V _{DC}	35	45	Volts
Maximum Average Forward Rectified Current see Fig. 1	I <sub(av)< sub=""></sub(av)<>	30		Amps
Peak Forward Surge Current, 8.3ms single half sine-wave superimposed on rated load (JEDEC Method)	I _{FSM}	200		Amps
Peak Repetitive Reverse Surge Current (Note 3)	I _{RSM}	2.0		Amps
Maximum Instantaneous Forward Voltage Per Leg I _F = 20A, T _C = 125°C (Note 2) I _F = 30A, T _C = 125°C I _F = 30A, T _C = 25°C	V _F	0.60 0.72 0.76		Volts
Maximum Instantaneous Reverse Current at T _C = 25°C	I _R	1.0		mA
Rated DC Blocking Voltage per element T _C = 125°C		60		
Maximum Thermal Resistance (Note 1)	R _{θJC}	1.4		°C/W
Voltage Rate of Change, (Rated V _R)	dv/dt	1000		V/us
Maximum Operating Temperature Range	T _C	-64 to +150		°C
Maximum Storage Temperature Range	T _{STG}	-65 to +175		°C

NOTES:

1. Thermal Resistance from Junction to Case.
2. Measured at 1MHz and applied reverse voltage of 4.0 volts.
3. 300 us Pulse Width, 2% Duty Factor.

RATINGS AND CHARACTERISTIC CURVES MBR3035PT AND MBR3045PT

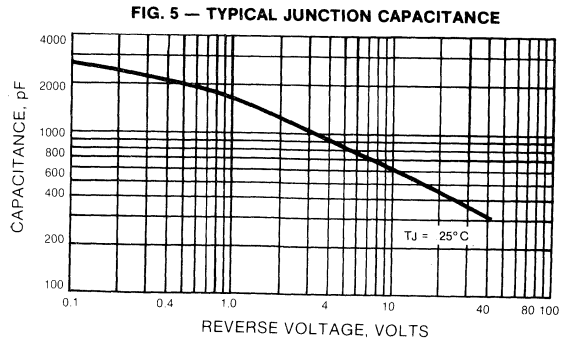
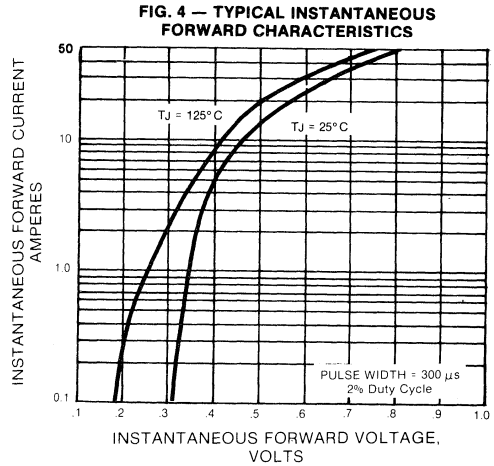
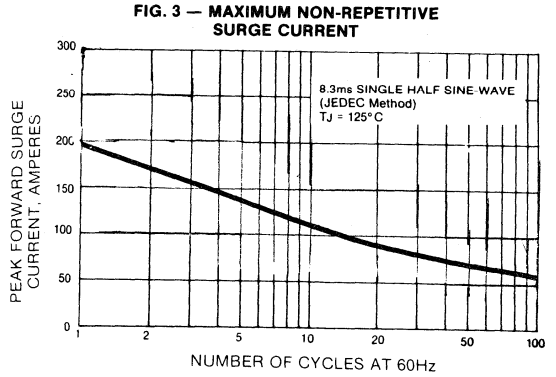
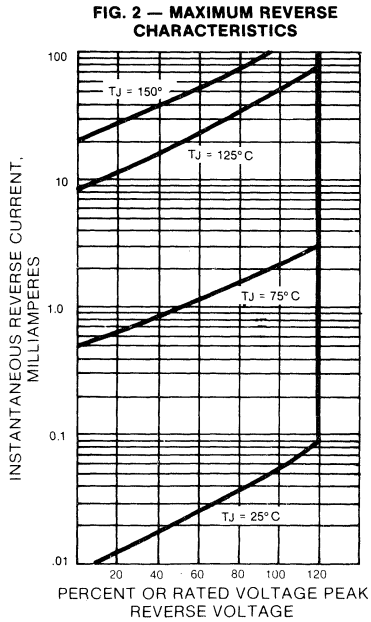
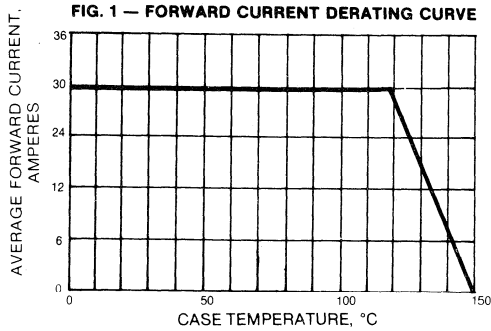

MBR3050PT AND MBR3060PT

SCHOTTKY RECTIFIER

VOLTAGE RANGE - 50 and 60 Volts CURRENT - 30 Amperes

FEATURES

- ◆ Dual rectifier construction, positive center-tap
- ◆ Plastic package has Underwriters Laboratory Flammability Classifications 94V-O
- ◆ Metal to silicon rectifier, majority carrier conduction
- ◆ Low power loss, high efficiency
- ◆ High current capability, low VF
- ◆ High surge capacity
- ◆ Epitaxial construction
- ◆ For use in low voltage, high frequency inverters, free wheeling, and polarity protection applications

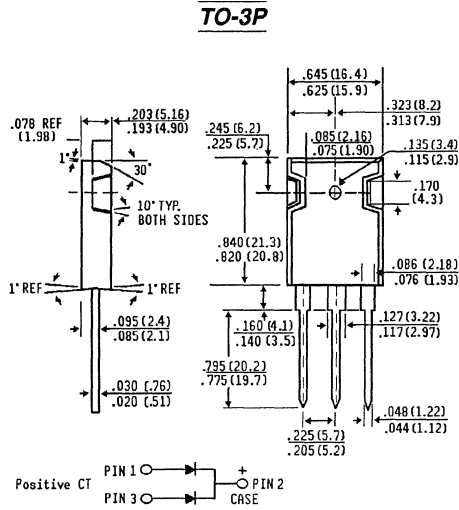
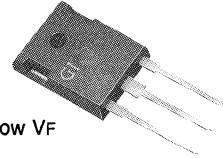

Dimensions in inches and (millimeters)

MECHANICAL DATA

Case: TO-3P

Terminals: Lead solderable per MIL-STD-202 Method 208

Polarity: As marked

Mounting Position: Any

Weight: .2 ounces, 5.6 gram

MAXIMUM RATINGS AND ELECTRICAL CHARACTERISTICS

Ratings at 25 °C ambient temperature unless otherwise specified.

Resistive or inductive load.

For capacitive or inductive load, derate current by 20%.

	SYMBOLS	MBR3050PT	MBR3060PT	UNITS
Maximum Recurrent Peak Reverse Voltage	V _{RRM}	50	60	Volts
Maximum RMS Voltage	V _{RMS}	35	42	Volts
Maximum DC Blocking Voltage	V _{DC}	50	60	Volts
Maximum Average Forward Rectified Current see Fig. 1	I _(AV)	30		Amps
Peak Forward Surge Current, 8.3ms single half sine-wave superimposed on rated load (JEDEC Method)	I _{FSM}	300		Amps
Maximum Instantaneous Forward Voltage Per Leg I _F = 20A, T _C = 25°C (Note 2) I _F = 20A, T _C = 25°C	V _F	.65 .75		Volts
Maximum Average Reverse Current at T _C = 25°C Rated Peak Reverse Voltage (Note 3) T _C = 100°C	I _R	5.0 100		mA
Typical Thermal Resistance (Note 1)	R _{θJC}	2.0		°C/W
Maximum Operating Temperature Range	T _C	-65 to +150		°C
Maximum Storage Temperature Range	T _{STG}	-65 to +175		°C

NOTES:

1. Thermal Resistance from Junction to Case.

2. 300 us Pulse Width, 2% Duty Factor.

RATINGS AND CHARACTERISTIC CURVES MBR3050PT AND MBR3060PT

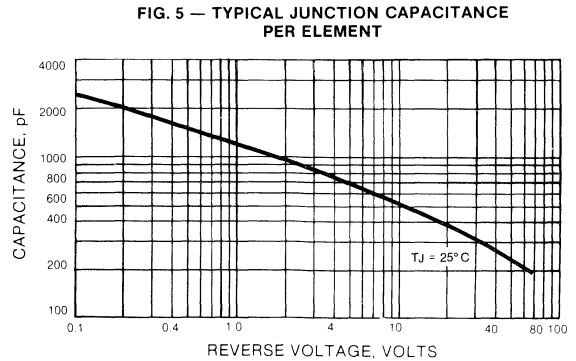
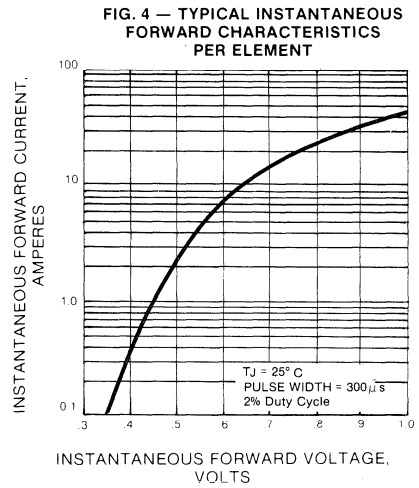
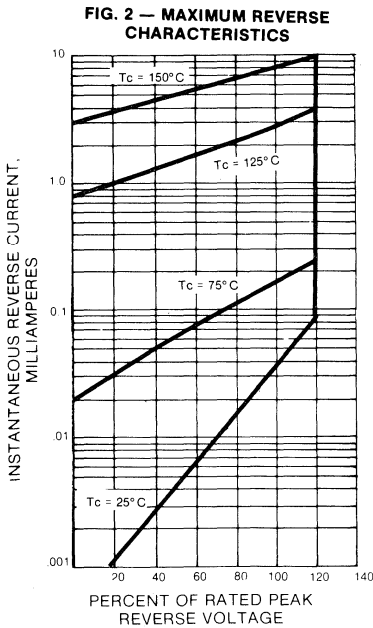
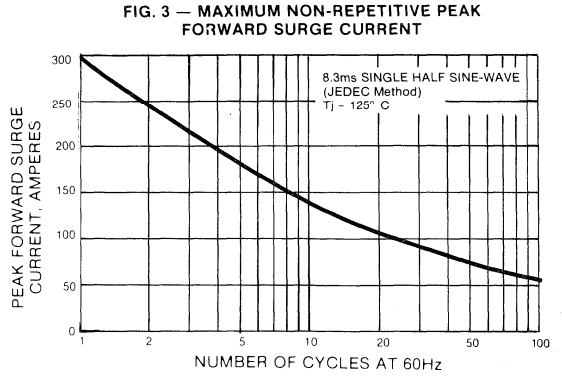
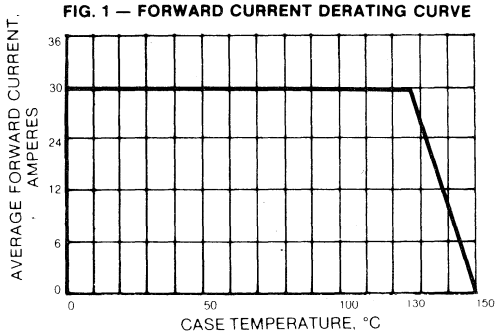

SBLF3030PT AND SBLF3040PT

SCHOTTKY RECTIFIER

VOLTAGE RANGE - 30 and 40 Volts CURRENT - 30 Amperes

FEATURES

- ◆ Dual rectifier construction, positive center-tap
- ◆ Isolated Plastic package has Underwriters Laboratory Flammability Classifications 94V-0
- ◆ Metal to silicon rectifier, majority carrier conduction
- ◆ Low power loss, high efficiency
- ◆ High current capability, low VF
- ◆ High surge capacity
- ◆ Epitaxial construction
- ◆ For use in low voltage, high frequency inverters, free wheeling, and polarity protection applications
- ◆ High temperature soldering guaranteed: 250°C/10 seconds, 17 (4.3mm) lead lengths at 5 lbs., (2.3kg) tension
- ◆ Guard Ring for transient protection
- ◆ Internal Insulation: 1.5k VRMS

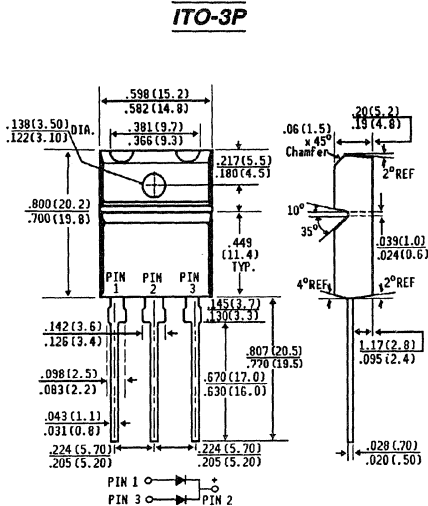
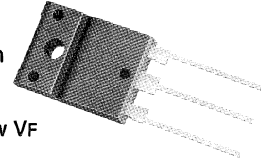

Dimensions in inches
and
(millimeters)

MECHANICAL DATA

Case: ITO-3P Molded Plastic

Terminals: Lead solderable per MIL-STD-202, Method 208

Polarity: As marked

Mounting Position: Any

Mounting Torque: 5 in. - lb. max.

Weight: .47 ounces, 13.2 ounces

MAXIMUM RATINGS AND ELECTRICAL CHARACTERISTICS

Ratings at 25°C ambient temperature unless otherwise specified. Resistive or inductive load. For capacitive load, derate current by 20%.

	SYMBOLS	SBLF3030PT	SBLF3040PT	UNITS
Maximum Recurrent Peak Reverse Voltage	V _{RRM}	30	40	Volts
Maximum RMS Voltage	V _{RMS}	21	28	Volts
Maximum DC Blocking Voltage	V _{DC}	30	40	Volts
Maximum Average Forward Rectified Current See Fig. 1	I <sub(av)< sub=""></sub(av)<>	30		Amps
Peak Forward Surge Current, 8.3ms single half sine-wave superimposed on rated load (JEDEC Method)	I _{FSM}	275		Amps
Maximum Instantaneous Forward Voltage Per Leg I _F = 15.0A, T _C = 25°C (Note 2)	V _F	.55		Volts
Maximum Average Reverse Current at T _C = 25°C		1.0		mA
Rated DC Blocking Voltage per element T _C = 100°C	I _R	75		mA
Maximum Thermal Resistance (Note 1)	R _{ΘJC}	2.5		°C/W
Operating and Storage Temperature Range	T _C , T _{STG}	-40 to +125		°C

NOTES:

1. Thermal Resistance from Junction to Case per element.
2. 300 us Pulse Width, 2% Duty Factor.

RATINGS AND CHARACTERISTIC CURVES SBLF3030PT AND SBLF3040PT

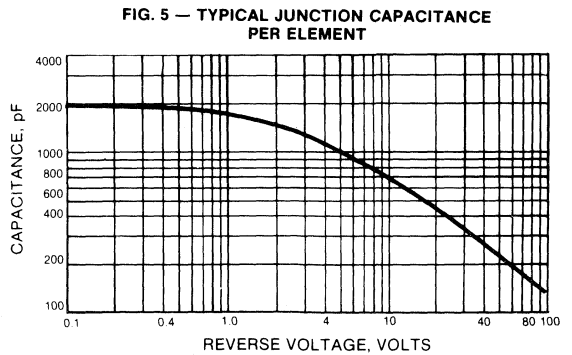
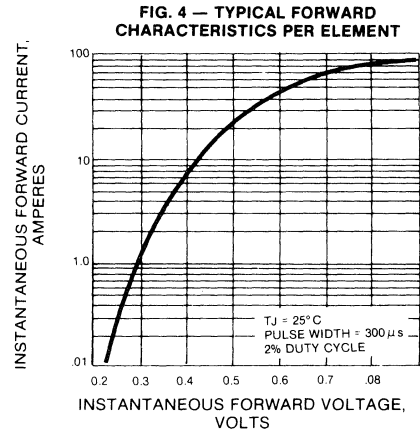
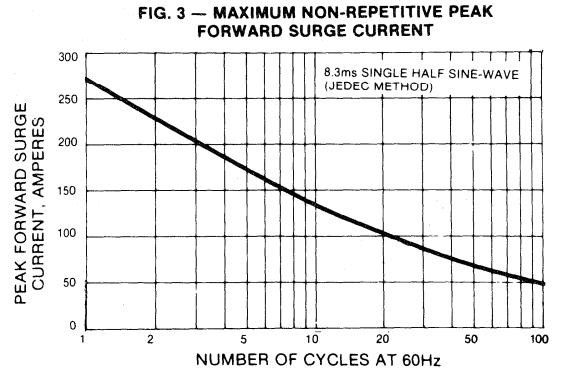
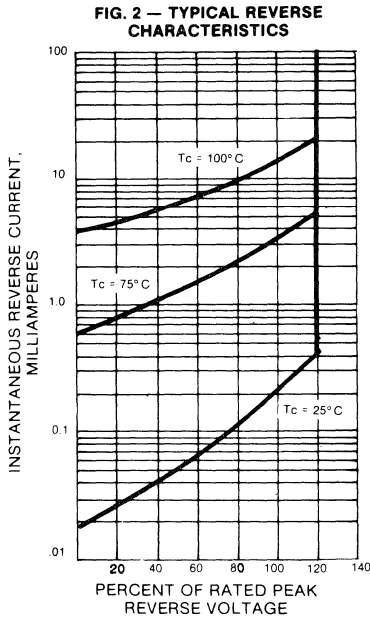
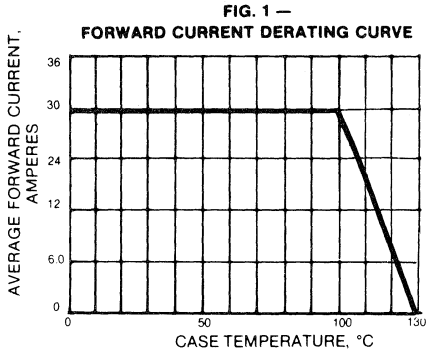

SBL3030PT AND SBL3040PT

SCHOTTKY RECTIFIER

VOLTAGE RANGE - 30 and 40 Volts CURRENT - 30 Amperes

FEATURES

- ◆ Dual rectifier construction, positive center-tap
- ◆ Plastic package has Underwriters Laboratory Flammability Classifications 94V-0
- ◆ Metal to silicon rectifier, majority carrier conduction
- ◆ Low power loss, high efficiency
- ◆ High current capability, low VF
- ◆ High surge capacity
- ◆ Epitaxial construction
- ◆ For use in low voltage, high frequency inverters, free wheeling, and polarity protection applications
- ◆ High temperature soldering guaranteed: 250°C/10 seconds, 17 (4.3mm) lead lengths at 5 lbs., (2.3kg) tension
- ◆ Guard Ring for transient protection

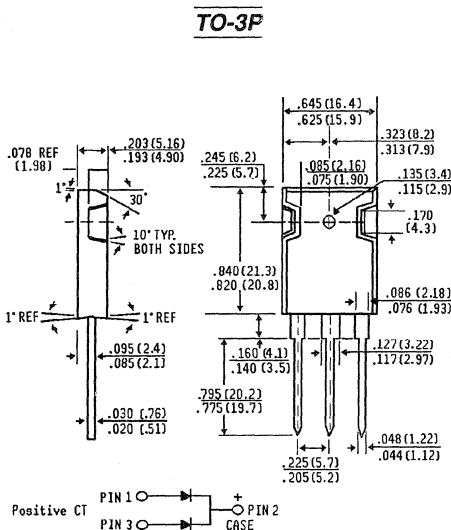
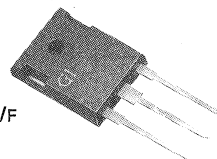

Dimensions in inches
and
(millimeters)

MECHANICAL DATA

Case: TO-3P Molded Plastic

Terminals: Lead solderable per MIL-STD-202 Method 208

Polarity: As marked

Mounting Position: Any

Weight: .2 ounces, 5.6 gram

CROSS - REFERENCE GUIDE

GI	FUJI	SHINDENGEN
SBL3030PT	- - -	S30SC3M
SBL3040PT	ESAD83-004	S30SCAM

MAXIMUM RATINGS AND ELECTRICAL CHARACTERISTICS

Ratings at °C ambient temperature unless otherwise specified. Resistive or inductive load. For capacitive or inductive load, derate current by 20%.

	SYMBOLS	SBL3030PT	SBL3040PT	UNITS
Maximum Recurrent Peak Reverse Voltage	V _{RRM}	30	40	Volts
Maximum RMS Voltage	V _{RMS}	21	28	Volts
Maximum DC Blocking Voltage	V _{DC}	30	40	Volts
Maximum Average Forward Rectified Current at T _C = 100°C	I _(AV)	30		Amps
Peak Forward Surge Current, 8.3ms single half sine-wave superimposed on rated load (JEDEC Method)	I _{FSM}	275		Amps
Maximum Instantaneous Forward Voltage Per Leg I _F = 15, T _C = 25°C (Note 2)	V _F	.55		Volts
Maximum Average Reverse Current at T _C = 25°C		1.0		mA
Rated DC Blocking Voltage per element T _C = 100°C	I _R	75		mA
Maximum Thermal Resistance (Note 1)	R _{ΘJC}	2.0		°C/W
Operating and Storage Temperature Range	T _C , T _{STG}	-40 to +125		°C

NOTES:

1. Thermal Resistance from Junction to Case.
2. 300 us Pulse Width, 2% Duty Factor.

RATINGS AND CHARACTERISTIC CURVES SBL3030PT AND SBL3040PT

FIG. 1 — FORWARD CURRENT DERATING CURVE

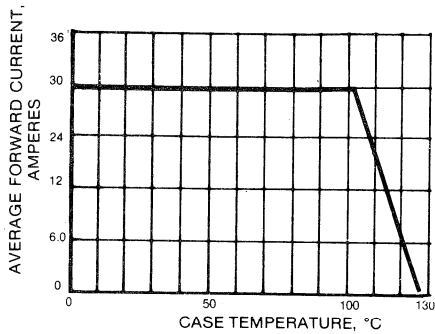

FIG. 3 — MAXIMUM NON-REPETITIVE PEAK FORWARD SURGE CURRENT

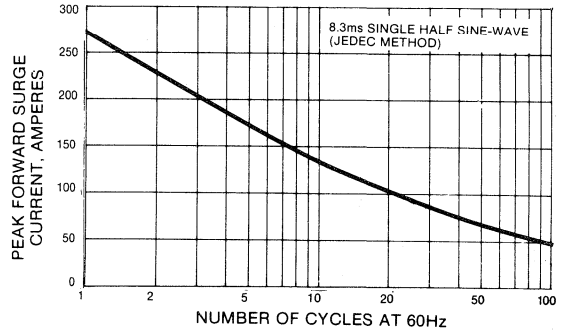

FIG. 4 — TYPICAL FORWARD CHARACTERISTICS PER ELEMENT

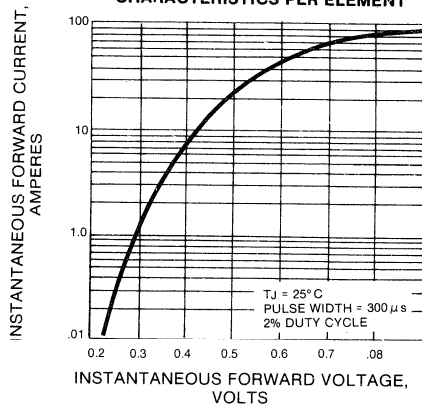

FIG. 2 — TYPICAL REVERSE CHARACTERISTICS

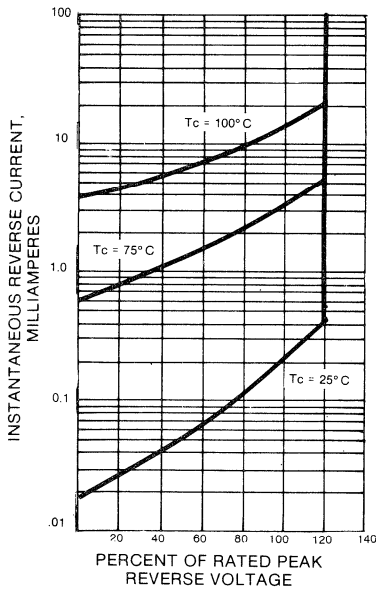
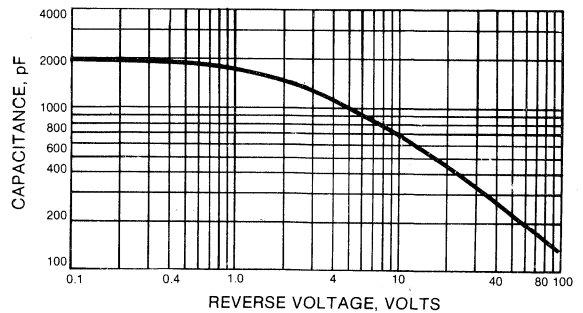

FIG. 5 — TYPICAL JUNCTION CAPACITANCE PER ELEMENT



SD241P

SCHOTTKY RECTIFIERS
VOLTAGE RANGE - 45 Volts CURRENT - 30 Amperes

FEATURES

- ◆ Dual rectifier construction, positive center-tap
- ◆ Plastic package has Underwriters Laboratory Flammability Classifications 94V-O
- ◆ Metal to silicon rectifier, majority carrier conduction using an epitaxial construction
- ◆ Low power loss, high efficiency
- ◆ High current capability, low VF
- ◆ High surge capacity
- ◆ For use in low voltage, high frequency inverters, free wheeling, and polarity protection applications
- ◆ High temperature soldering guaranteed: 300°C, .17", 4.3mm from case for 10 seconds
- ◆ Guard Ring for transient protection

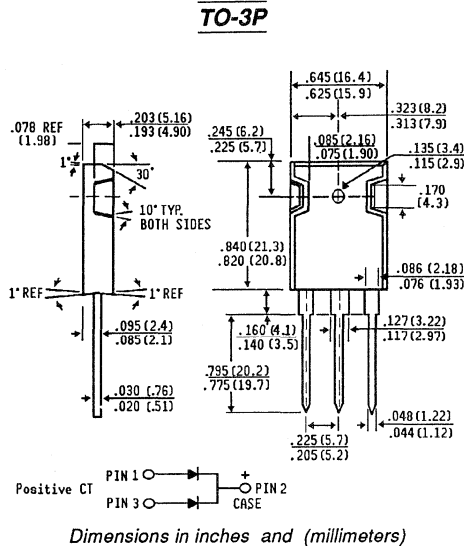
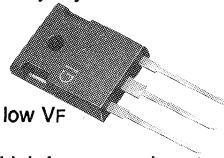

MECHANICAL DATA

Case: TO-3P

Terminals: Lead solderable per MIL-STD-202, Method 208

Polarity: As marked

Mounting Position: Any

Weight: .2 ounces, 5.6 gram

MAXIMUM RATINGS AND ELECTRICAL CHARACTERISTICS

Ratings at 25°C ambient temperature unless otherwise specified. Resistive or inductive load. For capacitive load, derate current by 20%

	SYMBOLS	SD241P	UNITS
Maximum Recurrent Peak Reverse Voltage at T _C = 25°C	V _{RRM}	45	Volts
Maximum Blocking Voltage at T _C = 25°C	V _{DC}	45	Volts
Maximum Average Forward Rectified Current see Fig. 1	I _(AV)	30	Amps
Peak Forward Surge Current 8.3ms single half sine-wave superimposed on rated load (JEDEC Method)	I _{FSM}	400	Amps
Peak Repetitive Reverse Surge Current (2.0us, 1KHz)	I _{RSM}	2.0	Amps
Maximum Instantaneous Forward Voltage Pulse Width = 300 us, Duty Cycle = 1% I _F = 10A, T _C = 125°C I _F = 20A, T _C = 125°C	V _F	.47 .60	Volts
Maximum Instantaneous Reverse Current Pulse Width = 400 us, Duty Cycle = 1% at 35V T _C = 25°C T _C = 125°C	I _R	25	mA
Maximum Voltage Rate of Change at 35V	dv/dt	1000	V/μs
Package Thermal Resistance (Note 1)	R _{θJC}	1.4	°C
Maximum Operating Temperature Range	T _C	-65 to +150	°C
Maximum Storage Temperature	T _{STG}	-65 to +175	°C

NOTES:

1. Thermal Resistance Junction of Case.

RATINGS AND CHARACTERISTIC CURVES SD241P

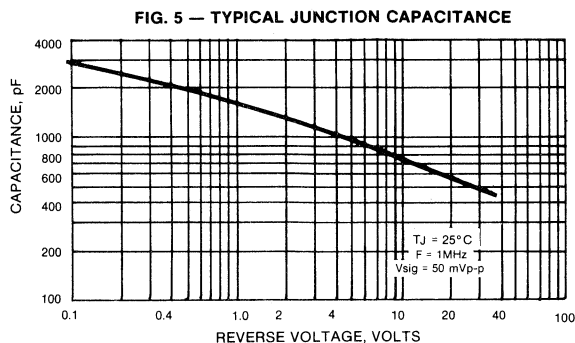
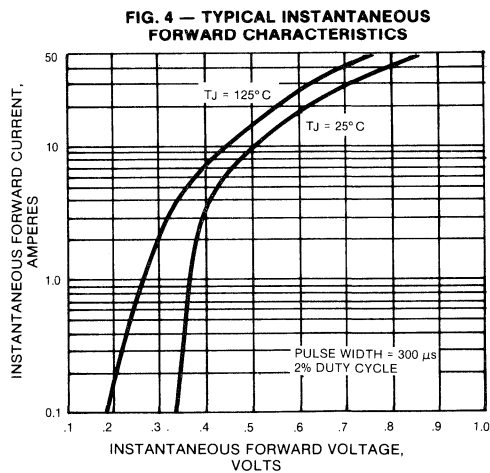
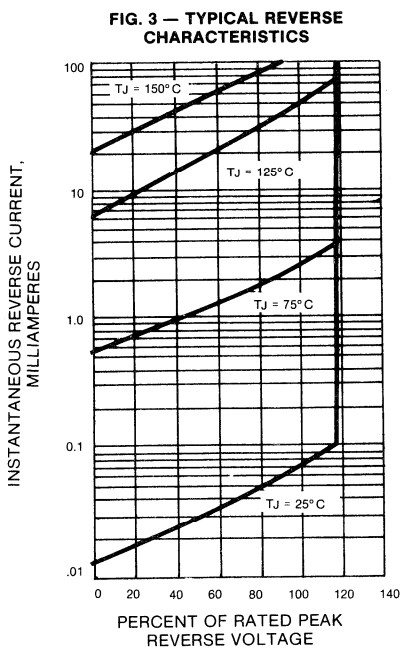
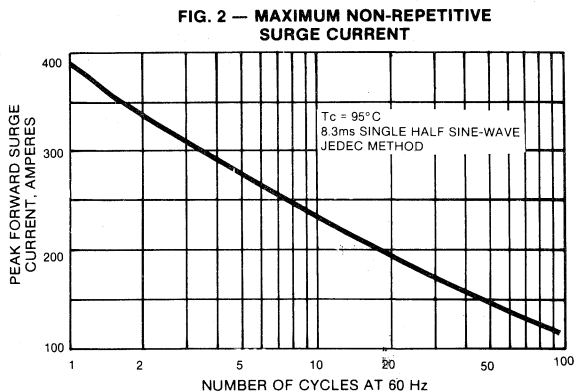
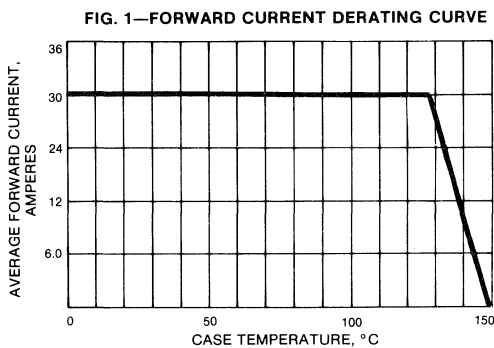

MBRF4035PT AND MBRF4045PT

SCHOTTKY RECTIFIER

VOLTAGE RANGE - 35 and 45 Volts CURRENT - 40 Amperes

FEATURES

- ◆ Dual rectifier construction, positive center-tap
- ◆ Isolated plastic package has Underwriters Laboratory Flammability Classifications 94V-0
- ◆ Metal to silicon rectifier, majority carrier conduction
- ◆ Low power loss, high efficiency
- ◆ High current capability, low VF
- ◆ High surge capacity
- ◆ Epitaxial construction
- ◆ For use in low voltage, high frequency inverters, free wheeling, and polarity protection applications
- ◆ Guard Ring for transient protection
- ◆ Internal Insulation: 1.5k VRMS

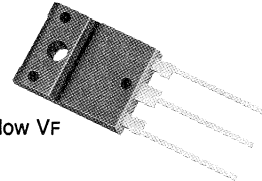

ITO-3P

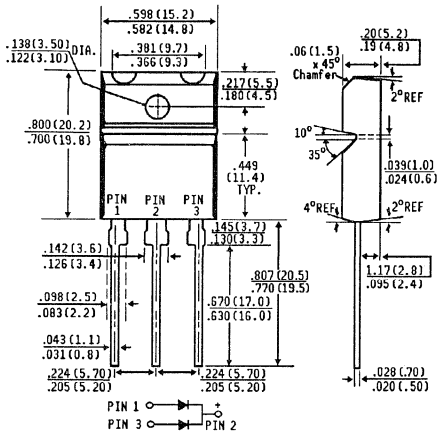

Dimensions in inches and (millimeters)

MECHANICAL DATA

Case: ITO-3P

Terminals: Leads solderable per MIL-STD-202, Method 208

Polarity: As marked

Mounting Position: Any

Mounting Torque: 5 in. - lb. max.

Weight: .47 ounces, 13.2 ounces

MAXIMUM RATINGS AND ELECTRICAL CHARACTERISTICS

Ratings at 25 °C ambient temperature unless otherwise specified.
Resistive or inductive load.
For capacitive or inductive load, derate current by 20%

	SYMBOLS	MBRF4035PT	MBRF4045PT	UNITS
Maximum Recurrent Peak Reverse Voltage	V_{RRM}	35	45	Volts
Maximum RMS Voltage	V_{RMS}	25	32	Volts
Maximum DC Blocking Voltage	V_{DC}	35	45	Volts
Maximum Average Forward Rectified Current See Fig.1	$I_{(AV)}$	40		Amps
Peak Forward Surge Current, 8.3ms single half sine-wave superimposed on rated load (JEDEC Method)	I_{FSM}	400		Amps
Maximum Instantaneous Forward Voltage Per leg $I_F = 20A, T_C = 125^\circ C$ (Note 2) $I_F = 20A, T_C = 25^\circ C$	V_F	.60	.70	Volts
Maximum Average Reverse Current at $T_C = 25^\circ C$	I_R	10		mA
Rated Peak Reverse Voltage (Note 2) $T_C = 100^\circ C$	I_R	100		mA
Typical Thermal Resistance (Note 1)	$R_{\theta JC}$	1.6		°C/W
Maximum Operating Temperature Range	T_C	-65 to +150		°C
Maximum Storage Temperature Range	T_{STG}	-65 to +175		°C

NOTES: 1. Thermal Resistance from Junction to Case per element.
2. 300 μs Pulse Width, 2% Duty Factor.

RATINGS AND CHARACTERISTIC CURVES MBRF4035PT AND MBRF4045PT

FIG. 1—FORWARD CURRENT DERATING CURVE

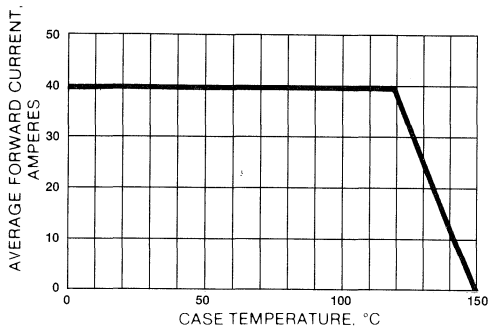

FIG. 2—MAXIMUM REVERSE CHARACTERISTICS

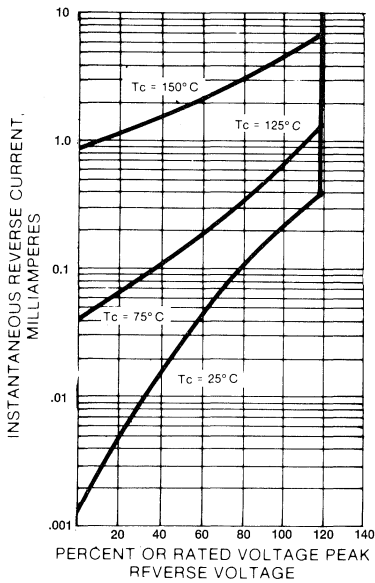

FIG. 3—MAXIMUM NON-REPETITIVE SURGE CURRENT

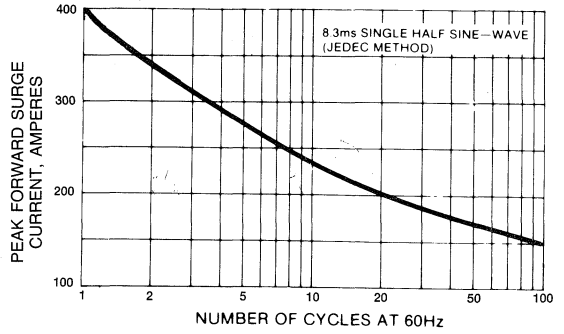

FIG. 4—TYPICAL REVERSE CHARACTERISTICS

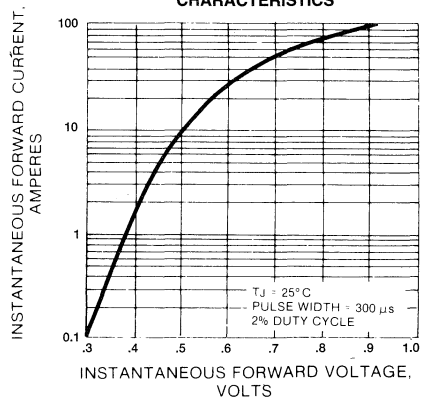
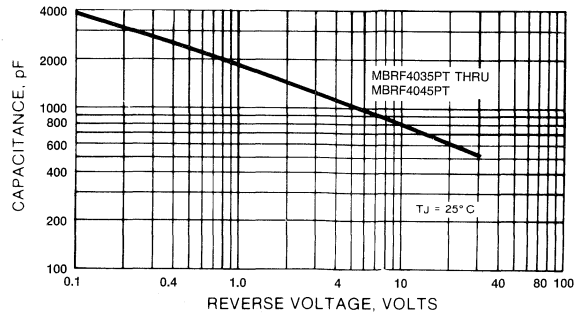

FIG. 5—TYPICAL JUNCTION CAPACITANCE



MBRF4050PT AND MBRF4060PT

SCHOTTKY RECTIFIER

VOLTAGE RANGE - 50 and 60 Volts CURRENT - 40 Amperes

FEATURES

- ◆ Dual rectifier construction, positive center-tap
- ◆ Isolated plastic package has Underwriters Laboratory Flammability Classifications 94V-O
- ◆ Metal to silicon rectifier, majority carrier conduction
- ◆ Low power loss, high efficiency
- ◆ High current capability, low Vf
- ◆ High surge capacity
- ◆ Epitaxial construction
- ◆ For use in low voltage, high frequency inverters, free wheeling, and polarity protection applications
- ◆ Guard Ring for transient protection
- ◆ Internal Insulation: 1.5k VRMS

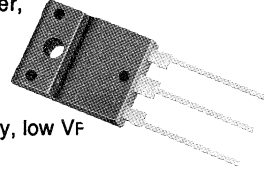

ITO-3P

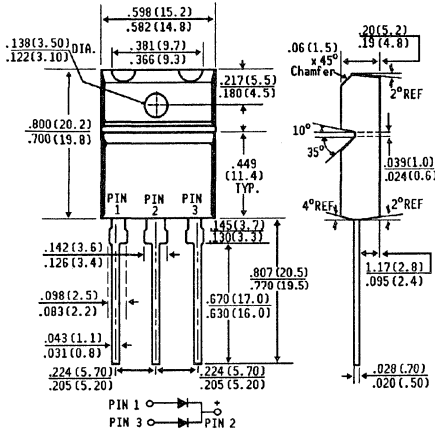

Dimensions in inches and (millimeters)

MECHANICAL DATA

Case: ITO-3P

Terminals: Leads solderable per MIL-STD-202, Method 208

Polarity: As marked

Mounting Position: Any

Mounting Torque: 5 in. - lb. max.

Weight: .47 ounces, 13.2 ounces

MAXIMUM RATINGS AND ELECTRICAL CHARACTERISTICS

Ratings at 25 °C ambient temperature unless otherwise specified.
Resistive or inductive load.
For capacitive or inductive load, derate current by 20%

	SYMBOLS	MBRF4050PT	MBRF4060PT	UNITS
Maximum Recurrent Peak Reverse Voltage	V _{RRM}	50	60	Volts
Maximum RMS Voltage	V _{RMS}	35	42	Volts
Maximum DC Blocking Voltage	V _{DC}	50	60	Volts
Maximum Average Forward Rectified Current See Fig.1	I _(AV)	40		Amps
Peak Forward Surge Current, 8.3ms single half sine-wave superimposed on rated load (JEDEC Method)	I _{FSM}	400		Amps
Maximum Instantaneous Forward Voltage Per leg I _F = 20A, T _C = 125°C (Note 2) I _F = 20A, T _C = 25°C	V _F	.70	.80	Volts
Maximum Average Reverse Current at T _C = 25°C Rated Peak Reverse Voltage (Note 2) T _C = 100°C	I _R	10	100	mA
Typical Thermal Resistance (Note 1)	R _{θJC}	1.6		°C/W
Maximum Operating Temperature Range	T _C	-65 to +150		°C
Maximum Storage Temperature Range	T _{STG}	-65 to +175		°C

NOTES:

1. Thermal Resistance from Junction to Case per element.
2. 300 μs Pulse Width, 2% Duty Factor.

RATINGS AND CHARACTERISTIC CURVES MBRF4050PT AND MBRF4060PT

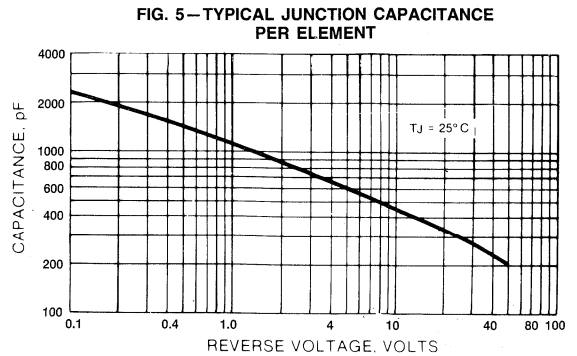
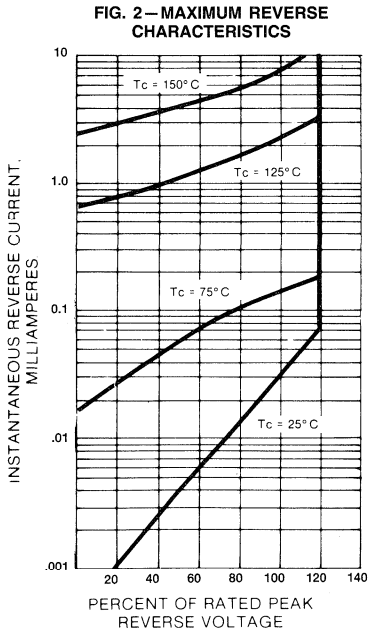
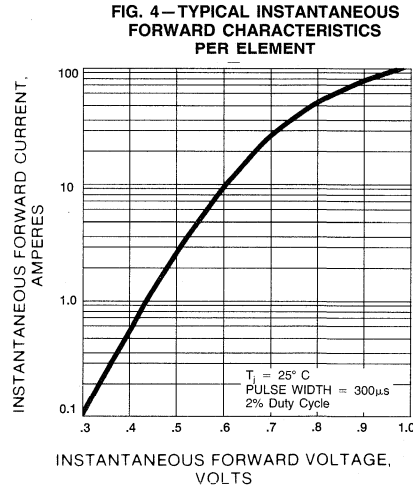
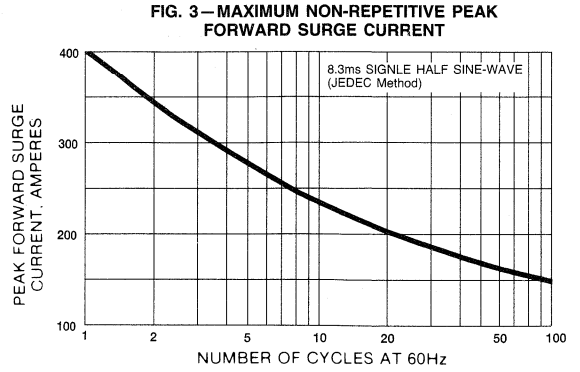
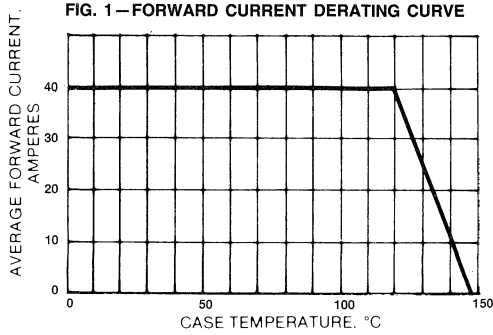

MBR4035PT AND MBR4045PT

SCHOTTKY RECTIFIER

VOLTAGE RANGE - 35 and 45 Volts CURRENT - 40 Amperes

FEATURES

- ◆ Dual rectifier construction, positive center-tap
- ◆ Plastic package has Underwriters Laboratory Flammability Classifications 94V-O
- ◆ Metal to silicon rectifier, majority carrier conduction
- ◆ Low power loss, high efficiency
- ◆ High current capability, low V_f
- ◆ High surge capacity
- ◆ Epitaxial construction
- ◆ For use in low voltage, high frequency inverters, free wheeling, and polarity protection applications
- ◆ Guard Ring for transient protection

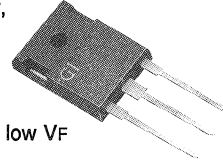

TO-3P

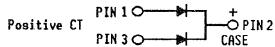
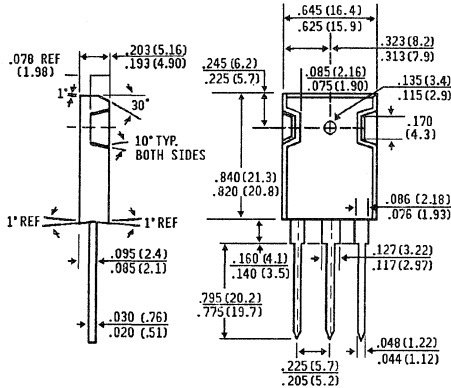

Dimensions in inches
and
(millimeters)

MECHANICAL DATA

Case: TO-3P

Terminals: Leads solderable per MIL-STD-202, Method 208

Polarity: As marked

Mounting Position: Any

Weight: .2 ounces, 5.6 gram

MAXIMUM RATINGS AND ELECTRICAL CHARACTERISTICS

Ratings at 25 °C ambient temperature unless otherwise specified.

Resistive or inductive load.

For capacitive or inductive load, derate current by 20%

	SYMBOLS	MBR4035PT	MBR4045PT	UNITS
Maximum Recurrent Peak Reverse Voltage	V_{RRM}	35	45	Volts
Maximum RMS Voltage	V_{RMS}	24.5	31.5	Volts
Maximum DC Blocking Voltage	V_{DC}	35	45	Volts
Maximum Average Forward Rectified Current at $T_c = 125^\circ\text{C}$	$I_{(AV)}$	40		Amps
Peak Forward Surge Current, 8.3ms single half sine-wave superimposed on rated load (JEDEC Method)	I_{FSM}	400		Amps
Maximum Instantaneous Forward Voltage at $T_c = 125^\circ\text{C}$ 20.0A, $T_c = 25^\circ\text{C}$ (Note 2)	V_f	.60	.70	Volts
Maximum Average Reverse Current at $T_c = 25^\circ\text{C}$	I_R	10		mA
Rated Peak Reverse Voltage (Note 3) $T_c = 100^\circ\text{C}$	I_R	100		mA
Typical Thermal Resistance (Note 1)	$R_{\theta JC}$	1.4		$^\circ\text{C/W}$
Maximum Operating Temperature Range	T_c	-65 to +150		$^\circ\text{C}$
Maximum Storage Temperature Range	T_{STG}	-65 to +175		$^\circ\text{C}$

NOTES:

1. Thermal Resistance from Junction to Case.

2. 300 μs Pulse Width, 2% Duty Factor.

RATINGS AND CHARACTERISTIC CURVES MBR4035PT AND MBR4045PT

FIG. 1 — FORWARD CURRENT DERATING CURVE

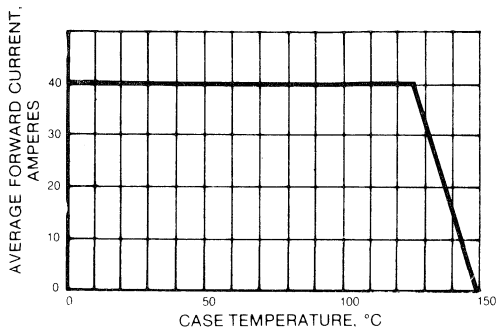

FIG. 3 — MAXIMUM NON-REPETITIVE SURGE CURRENT

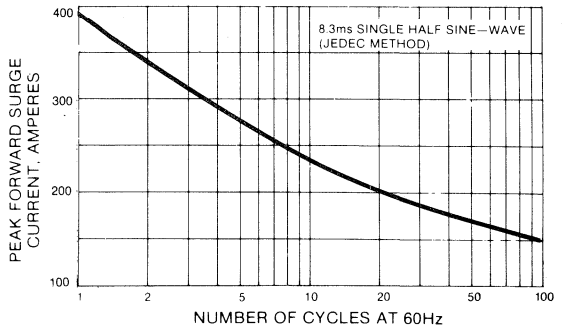

FIG. 4 — TYPICAL REVERSE CHARACTERISTICS

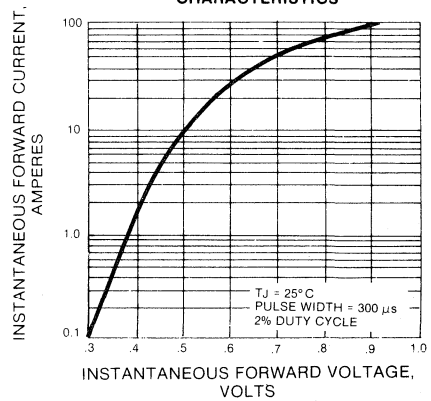

FIG. 2 — MAXIMUM REVERSE CHARACTERISTICS

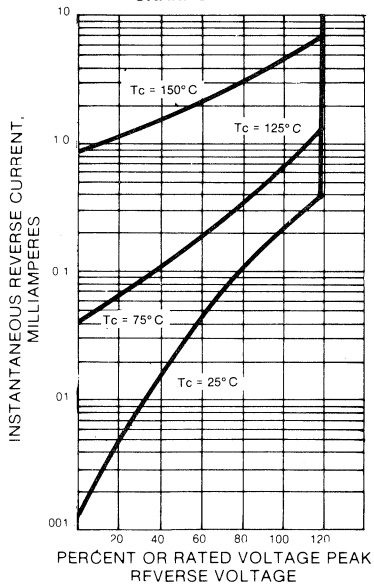
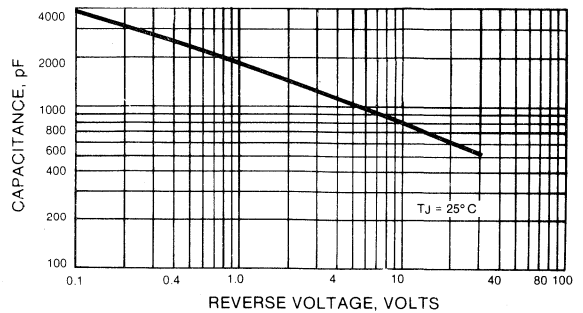

FIG. 5 — TYPICAL JUNCTION CAPACITANCE



MBR4050PT AND MBR4060PT

SCHOTTKY RECTIFIER

VOLTAGE RANGE - 50 and 60 Volts CURRENT - 40 Amperes

FEATURES

- ◆ Dual rectifier construction, positive center-tap
- ◆ Plastic package has Underwriters Laboratory Flammability Classifications 94V-0
- ◆ Metal to silicon rectifier, majority carrier conduction
- ◆ Low power loss, high efficiency
- ◆ High current capability, low V_f
- ◆ High surge capacity
- ◆ Epitaxial construction
- ◆ For use in low voltage, high frequency inverters, free wheeling, and polarity protection applications
- ◆ Guard Ring for transient protection

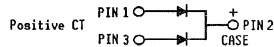
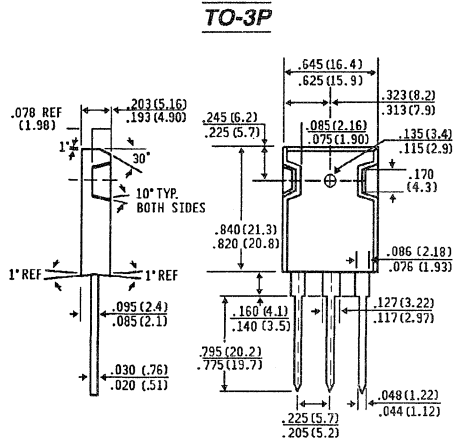
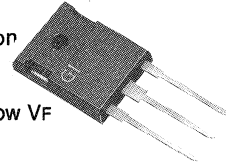

Dimensions in inches
and
(millimeters)

MECHANICAL DATA

Case: TO-3P

Terminals: Lead solderable per MIL-STD-202 Method 208

Polarity: As marked

Mounting Position: Any

Weight: .2 ounces, 5.6 gram

MAXIMUM RATINGS AND ELECTRICAL CHARACTERISTICS

Ratings at 25°C ambient temperature unless otherwise specified.

Resistive or inductive load.

For capacitive or inductive load, derate current by 20%.

	SYMBOLS	MBR4050PT	MBR4060PT	UNITS
Maximum Recurrent Peak Reverse Voltage	V_{RRM}	50	60	Volts
Maximum RMS Voltage	V_{RMS}	35	42	Volts
Maximum DC Blocking Voltage	V_{DC}	50	60	Volts
Maximum Average Forward Rectified Current at $T_C = 120^\circ\text{C}$	$I_{(AV)}$	40		Amps
Peak Forward Surge Current, 8.3ms single half sine-wave superimposed on rated load (JEDEC Method)	I_{FSM}	400		Amps
Maximum Instantaneous Forward Voltage Per Leg $I_F = 20\text{A}$, $T_C = 25^\circ\text{C}$ (Note 2) $I_F = 20\text{A}$, $T_C = 25^\circ\text{C}$	V_F	.70 .80		Volts
Maximum Average Reverse Current at $T_C = 25^\circ\text{C}$		10		
Rated Peak Reverse Voltage (Note 3) $T_C = 100^\circ\text{C}$	I_R	100		mA
Typical Thermal Resistance (Note 1)	$R_{\theta JC}$	1.4		$^\circ\text{C/W}$
Maximum Operating Temperature Range	T_C	-65 to + 150		$^\circ\text{C}$
Maximum Storage Temperature Range	T_{STG}	-65 to +175		$^\circ\text{C}$

NOTES:

1. Thermal Resistance from Junction to Case.

2. 300 us Pulse Width, 2% Duty Factor.

RATINGS AND CHARACTERISTIC CURVES MBR4050PT AND MBR4060PT

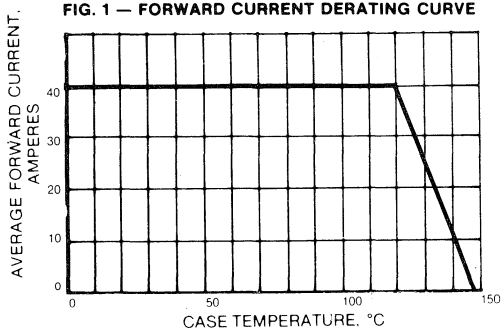

FIG. 3 — MAXIMUM NON-REPETITIVE PEAK FORWARD SURGE CURRENT

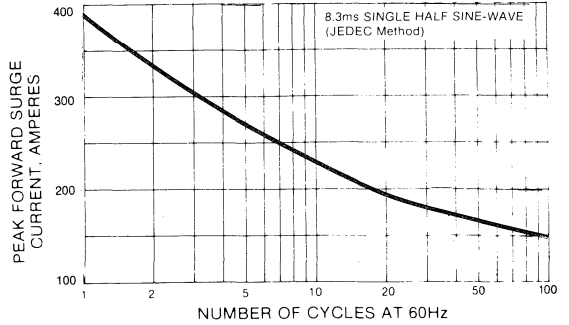

FIG. 4 — TYPICAL INSTANTANEOUS FORWARD CHARACTERISTICS PER ELEMENT

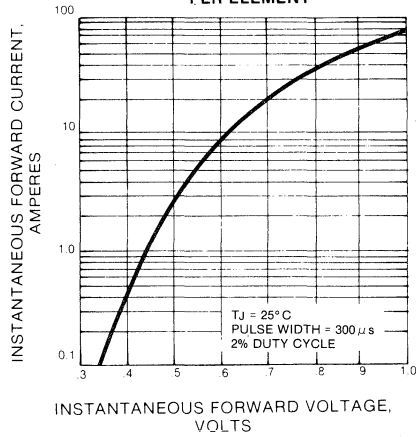
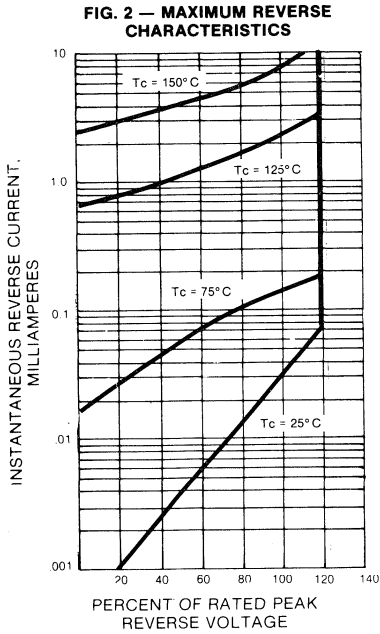
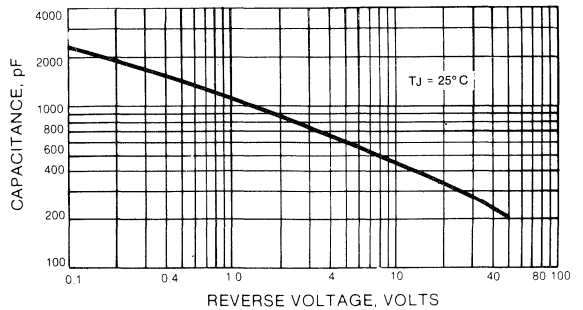

FIG. 5 — TYPICAL JUNCTION CAPACITANCE PER ELEMENT



FAST EFFICIENT RECTIFIERS

1 AMPERE TO 30 AMPERES

**SEE
NEW
ISOLATED
PACKAGES**



**GENERAL
INSTRUMENT**

LOW CURRENT AXIAL FAST EFFICIENT RECTIFIERS

TYPE	FE1A thru FE1D	GH1001 thru GH1004	FE2A thru FE2D	BYV27-50 thru BYV27-200	GH1101 thru GH1104	FE3A thru FE3D	BYV28-50 thru BYV28-200	FE5A thru FE5D	FE6A thru FE6D	GH1301 thru GH1304
PACKAGE	DO-204AP	DO-204AP	DO-240AP	DO-204AP	DO-204AP	G4	G4	G4	G4	G4
Io(A)	1	1	2	2	2.5	3.0	3.5	5.0	6.0	6.0
VR=50(V)	FE1A	GH1001	FE2A	BYV27-50	GH1101	FE3A	BYV28-50	FE5A	FE6A	GH1301
VR=100(V)	FE1B	GH1002	FE2B	BYV27-100	GH1102	FE3B	BYV28-100	FE5B	FE6B	GH1302
VR=150(V)	FE1C	GH1003	FE2C	BYV27-150	GH1103	FE3C	BYV28-150	FE5C	FE6C	GH1303
VR=200(V)	FE1D	GH1004	FE2D	BYV27-200	GH1104	FE3D	BYV28-200	FE5D	FE6D	GH1304
VR=300(V)										
VR=400(V)										
VR=500(V)										
VR=600(V)										
VR=800(V)										
VR=1000(V)										

LOW CURRENT AXIAL FAST EFFICIENT RECTIFIERS

TYPE	EGP10A thru EGP10D	EGP20A thru EGP20D	EGP30A thru EGP30D	EGP50A thru EGP50D	UF4001 thru UF4007	UF5400 thru UF5408
PACKAGE	DO-41	DO-15	GP-20	GP-20	DO-41	DO-201AD
Io(A)	1.0	2.0	3.0	5.0	1.0	3.0
VR=50(V)	EGP10A	EGP20A	EGP30A	EGP50A	UF4001	UF5400
VR=100(V)	EGP10B	EGP20B	EGP30B	EGP50B	UF4002	UF5401
UV=150(V)	EGP10C	EGP20C	EGP30C	EGP50C		
VR=200(V)	EGP10D	EGP20D	EGP30D	EGP50D	UF4003	UF5402
VR=300(V)	EGP10F	EGP20F	EGP30F	EGP50F		UF5403
VR=400(V)	EGP10G	EGP20G	EGP30G	EGP50G	UF4004	UF5404
UV=500(V)					UF5005	UF5405
VR=600(V)					UF5006	UF5406
VR=800(V)					UF5007	UF5407
VR=1000(V)						

CONT.

MEDIUM CURRENT FAST EFFICIENT RECTIFIERS

SINGLE RECTIFIERS

TYPE	FESF8AT thru FESF8JT	FES8AT thru FES8JT	GI1401 thru GI1404	BYW29-50 thru BYW29-200	FESF16AT thru FESF16JT	FES16AT thru FES16JT
PACKAGE	ITO-220	TO-220	TO-220	TO-220	ITO-220	TO-220
IO(A)	6	8	8	8	16	16
VR=50(V)	FESF8AT	FES8AT	GI1401	BYW29-50	FESF16AT	FES16AT
VR=100(V)	FESF8BT	FES8BT	GI1402	BYW29-100	FESF16BT	FES16BT
VR=150(V)	FESF8CT	FES8CT	GI1403	BYW29-150	FESF16CT	FES16CT
VR=200(V)	FESF8DT	FES8DT	GI1404	BYW29-200	FESF16DT	FES16DT
VR=300(V)	FESF8FT	FES8FT			FESF16FT	FES16FT
VR=400(V)	FESF8GT	FES8GT			FESF16GT	FES16GT
VR=500(V)	FESF8HT	FES8HT			FESF16HT	FES16HT
VR=600(V)	FESF8JT	FES8JT			FESF16JT	FES16JT

MEDIUM CURRENT FAST EFFICIENT RECTIFIERS

DUAL RECTIFIERS

TYPE	FEPF6AT THRU FEPF6DT	FEP6AT THRU FEP6DT	FEPF16AT THRU FEPF16JT	FEP16AT THRU FEP16JT	GI2401 THRU GI2404	BYV32-50 THRU BYV32-200	FEPF30AP THRU FEPF30JP	FEP30AP THRU FEP30JP
PACKAGE	ITO-220CT	TO-220CT	ITO-220CT	TO-220CT	TO-220CT	TO-220CT	ITO-3P	TO-3P
IO(A)	6	6	16	16	16	16	30	30
VR=50(V)	FEPF6AT	FEP6AT	FEPF16AT	FEP16AT	GI2401	BYV32-50	FEPF30AP	FEP30AP
VR=100(V)	FEPF6BT	FEP6BT	FEPF16BT	FEP16BT	GI2402	BYV32-100	FEPF30BP	FEP30BP
VR=150(V)	FEPF6CT	FEP6CT	FEPF16CT	FEP16CT	GI2403	BYV32-150	FEPF30CP	FEP30CP
VR=200(V)	FEPF6DT	FEP6DT	FEPF16DT	FEP16DT	GI2404	BYV32-200	FEPF30DP	FEP30DP
VR=300(V)			FEPF16FT	FEP16FT			FEPF30FP	FEP30FP
VR=400(V)			FEPF16GT	FEP16GT			FEPF30GP	FEP30GP
VR=500(V)			FEPF16HT	FEP16HT			FEPF30HP	FEP30HP
VR=600(V)			FEPF16JT	FEP16JT			FEPF30JP	FEP30JP

**GLASS PASSIVATED
FAST EFFICIENT
RECTIFIERS**

1.0 AMPERE TO 6.0 AMPERES

**GENERAL
INSTRUMENT**

FE1A THRU FE1D

GLASS PASSIVATED FAST EFFICIENT RECTIFIER
Voltage - 50 to 200 Volts Current - 1.0 Amperes

FEATURES

PATENTED*

DO-204AP

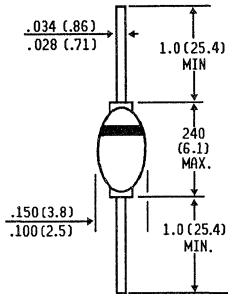

Dimensions in inches and (millimeters)

- ◆ Glass passivated cavity-free junction
- ◆ Superfast recovery times-epitaxial construction
- ◆ Low forward voltage, high current capability
- ◆ Capable of meeting environmental standards of MIL-S-19500
- ◆ Hermetically sealed
- ◆ Low Leakage
- ◆ High surge capability
- ◆ High temperature metallurgically bonded, no compression contacts
- ◆ High temperature soldering guaranteed: 350°C/10 seconds/.375", (9.5mm) lead length at 5 lbs., (2.3kg) tension

MECHANICAL DATA

Case: Unitized glass hermetically sealed

Terminals: Axial leads, solderable per MIL-STD-202, Method 208

Polarity: Color band denotes cathode

Mounting Position: Any

Weight: 0.02 ounce, 0.6 gram

* Brazed-lead assembly is covered by Patent No. 3,930,306 of 1976 and glass composition by Patent No. 3,752,701 of 1973

MAXIMUM RATINGS AND ELECTRICAL CHARACTERISTICS

Ratings at 25°C ambient temperature unless otherwise specified.
 Resistive or inductive load.
 For capacitive load, derate current by 20%.

	SYMBOLS	FE1A	FE1B	FE1C	FE1D	UNITS
Maximum Recurrent Peak Reverse Voltage	VRRM	50	100	150	200	Volts
Maximum RMS Voltage	VRMS	35	70	105	140	Volts
Maximum DC Blocking Voltage	VDC	50	100	150	200	Volts
Maximum Average Forward Rectified Current .375", (9.5mm) Lead Lengths at T _L = 75°C	I _(AV)	1.0				Amps
Peak Forward Surge Current 8.3 ms single half sine-wave superimposed on rated load (JEDEC Method) T _A = 55°C	I _{FSM}	30.0				Amps
Maximum Instantaneous Forward Voltage at 1.0A	V _F	0.95				Volts
Maximum DC Reverse Current T _A = 25°C at Rated DC Blocking Voltage T _A = 150°C	I _R	50.0				μA
Maximum Reverse Recovery Time (Note 1)	T _{RR}	35.0				Ns
Typical Junction Capacitance (Note 2)	C _J	45.0				pf
Typical Thermal Resistance (Note 3)	RθJA	65				°C/W
Operating and Storage Temperature Range	T _J , T _{STG}	-65 to +175				°C

NOTES:

1. Reverse Recovery Test Conditions : I_F = 0.5A, I_R = 1.0A, recover to 0.25A.
2. Measured at 1.0 MHz and applied reverse voltage of 4.0 Volts.
3. Thermal Resistance from Junction to Ambient at .375" (9.5mm) Lead Lengths.

RATINGS AND CHARACTERISTIC CURVES FE1A THRU FE1D

FIG. 1 — REVERSE RECOVERY TIME CHARACTERISTIC AND TEST DIAGRAM

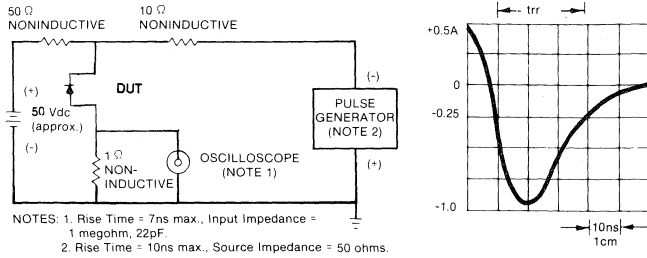

FIG. 2 — MAXIMUM AVERAGE FORWARD CURRENT RATING

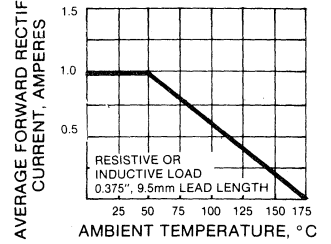

FIG. 3 — TYPICAL REVERSE CHARACTERISTICS

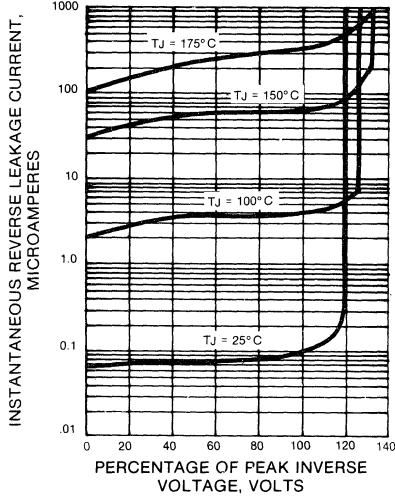

FIG. 4 — TYPICAL FORWARD CHARACTERISTICS

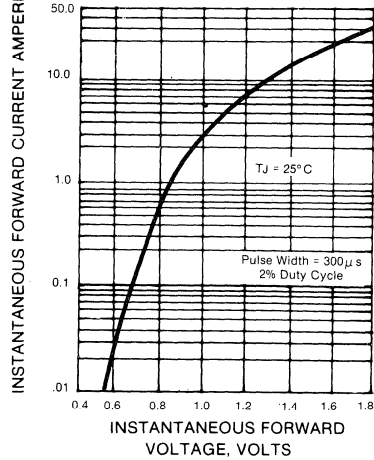

FIG. 5 — MAXIMUM NON-REPETITIVE PEAK FORWARD SURGE CURRENT

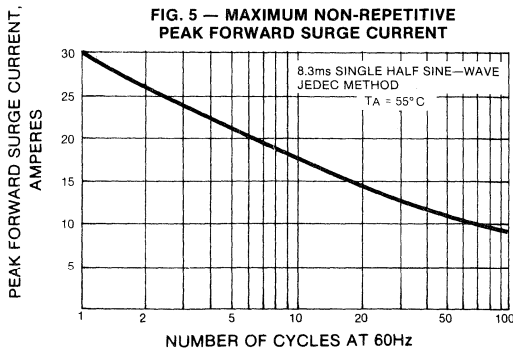
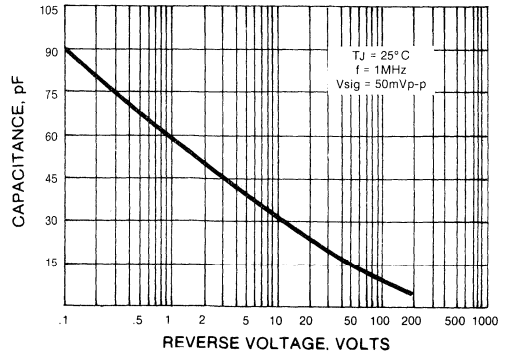

FIG. 6 — TYPICAL JUNCTION CAPACITANCE



**GENERAL
INSTRUMENT**

GI1001 THRU GI1004

GLASS PASSIVATED FAST EFFICIENT RECTIFIER
Voltage - 50 to 200 Volts Current - 1.0 Amperes

FEATURES

PATENTED*

DO-204AP

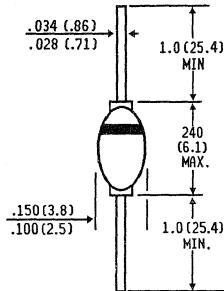

Dimensions in inches and (millimeters)

- ◆ Glass passivated cavity-free junction
- ◆ Superfast recovery times-epitaxial construction
- ◆ Low forward voltage, high current capability
- ◆ Capable of meeting environmental standards of MIL-S-19500
- ◆ Hermetically sealed
- ◆ Low Leakage
- ◆ High surge capability
- ◆ High temperature metallurgically bonded, no compression contacts
- ◆ High temperature soldering guaranteed: 350°C/10 seconds/.375", (9.5mm) lead length at 5 lbs., (2.3kg) tension

MECHANICAL DATA

Case: Unitized glass hermetically sealed

Terminals: Axial leads, solderable per MIL-STD-202, Method 208

Polarity: Color band denotes cathode

Mounting Position: Any

Weight: 0.02 ounce, 0.6 gram

* Brazed-lead assembly is covered by Patent No. 3,930,306 of 1976 and glass composition by Patent No. 3,752,701 of 1973

MAXIMUM RATINGS AND ELECTRICAL CHARACTERISTICS

Ratings at 25°C ambient temperature unless otherwise specified.
 Resistive or inductive load.
 For capacitive load, derate current by 20%.

	SYMBOLS	GI1001	GI1002	GI1003	GI1004	UNITS
Maximum Recurrent Peak Reverse Voltage	V _{RRM}	50	100	150	200	Volts
Maximum RMS Voltage	V _{RMS}	35	70	105	140	Volts
Maximum DC Blocking Voltage	V _{DC}	50	100	150	200	Volts
Maximum Average Forward Rectified Current .375", (9.5mm) Lead Lengths at T _L = 75°C	I _(AV)	1.0				Amps
Peak Forward Surge Current 10ms single half sine-wave superimposed on rated load (JEDEC Method)	I _{FSM}	30.0				Amps
Maximum Instantaneous Forward Voltage at 1.0A	V _F	.975				Volts
Maximum DC Reverse Current T _A = 25°C at Rated DC Blocking Voltage T _A = 100°C	I _R	50				μA
Maximum Reverse Recovery Time (Note 1)	T _{RR}	25				Ns
Typical Junction Capacitance (Note 2)	C _J	45.0				pf
Typical Thermal Resistance (Note 3)	R _{ΘJL}	20				°C/W
Operating and Storage Temperature Range	T _J , T _{STG}	-65 to +175				°C

NOTES:

1. Reverse Recovery Test Conditions : I_F = 0.5A, I_R = 1.0A, recover to 0.25A.
2. Measured at 1.0 MHZ and applied reverse voltage of 4.0 Volts.
3. Thermal Resistance from Junction to Lead at .375" (9.5mm) Lead Lengths.

RATINGS AND CHARACTERISTIC CURVES G11001 THRU G11004

FIG. 1 — REVERSE RECOVERY TIME CHARACTERISTIC AND TEST DIAGRAM

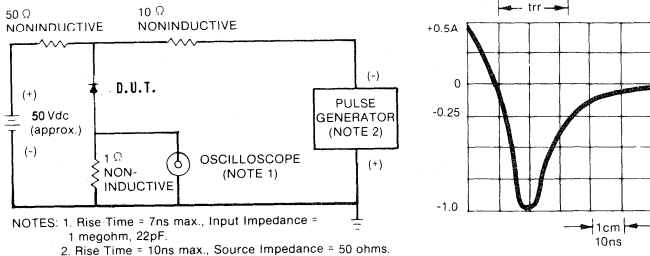

FIG. 2 — MAXIMUM AVERAGE FORWARD CURRENT RATING

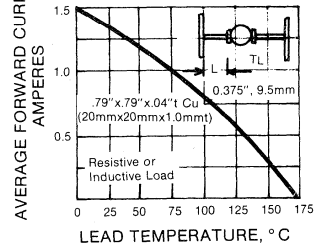

FIG. 3 — TYPICAL REVERSE CHARACTERISTICS

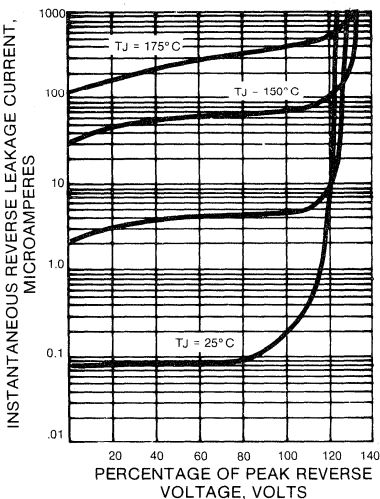

FIG. 4 — TYPICAL FORWARD CHARACTERISTICS

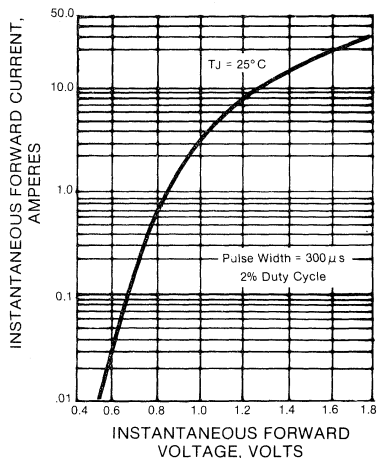

FIG. 5 — MAXIMUM NON-REPETITIVE PEAK FORWARD SURGE CURRENT

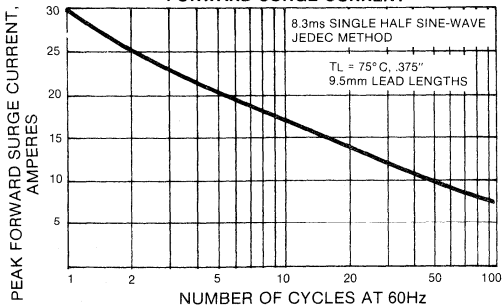
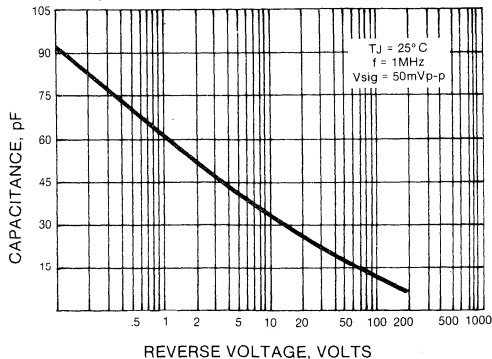

FIG. 6 — TYPICAL JUNCTION CAPACITANCE



FE2A THRU FE2D

GLASS PASSIVATED FAST EFFICIENT RECTIFIER

Voltage - 50 to 200 Volts Current - 2.0 Amperes

FEATURES

PATENTED*

DO-204AP

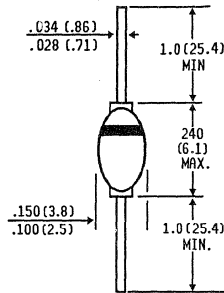

Dimensions in inches and (millimeters)

* Brazed-lead assembly is covered by Patent No. 3,930,306 of 1976 and glass composition by Patent No. 3,752,701 of 1973

- ◆ Glass passivated cavity-free junction
- ◆ Superfast recovery times-epitaxial construction
- ◆ Low forward voltage, high current capability
- ◆ Capable of meeting environmental standards of MIL-S-19500
- ◆ Hermetically sealed
- ◆ Low Leakage
- ◆ High surge capability
- ◆ High temperature metallurgically bonded, no compression contacts
- ◆ High temperature soldering guaranteed: 350°C/10 seconds/.375", (9.5mm) lead length at 5 lbs., (2.3kg) tension

MECHANICAL DATA

Case: Unitized glass hermetically sealed

Terminals: Axial leads, solderable per MIL-STD-202, Method 208

Polarity: Color band denotes cathode

Mounting Position: Any

Weight: 0.02 ounce, 0.6 gram

MAXIMUM RATINGS AND ELECTRICAL CHARACTERISTICS

Ratings at 25°C ambient temperature unless otherwise specified.
Resistive or inductive load.
For capacitive load, derate current by 20%.

	SYMBOLS	FE2A	FE2B	FE2C	FE2D	UNITS
Maximum Recurrent Peak Reverse Voltage	V_{RRM}	50	100	150	200	Volts
Maximum RMS Voltage	V_{RMS}	35	70	105	140	Volts
Maximum DC Blocking Voltage	V_{DC}	50	100	150	200	Volts
Maximum Average Forward Rectified Current .375", (9.5mm) Lead Lengths at $T_L = 75^\circ C$	$I_{(AV)}$	2.0				Amps
Peak Forward Surge Current 10ms single half sine-wave superimposed on rated load (JEDEC Method) $T_A = 55^\circ C$	I_{FSM}	50.0				Amps
Maximum Instantaneous Forward Voltage at 2.0A	V_F	0.95				Volts
Maximum DC Reverse Current $T_A = 25^\circ C$ at Rated DC Blocking Voltage $T_A = 150^\circ C$	I_R	50.0				μA
Maximum Reverse Recovery Time (Note 1)	T_{RR}	35.0				Ns
Typical Junction Capacitance (Note 2)	C_J	45.0				pf
Typical Thermal Resistance (Note 3)	$R_{\theta JA}$	60				$^\circ C/W$
Operating and Storage Temperature Range	T_J, T_{STG}	-65 to +175				$^\circ C$

NOTES:

1. Reverse Recovery Test Conditions : $I_F = 0.5A$, $I_R = 1.0A$, recover to 0.25A.
2. Measured at 1.0 MHz and applied reverse voltage of 4.0 Vdc.
3. Thermal Resistance from Junction to Ambient at .375" (9.5mm) Lead Lengths, P.C. Board Mounted.

RATINGS AND CHARACTERISTIC CURVES FE2A THRU FE2D

FIG. 1 — REVERSE RECOVERY TIME CHARACTERISTIC AND TEST DIAGRAM

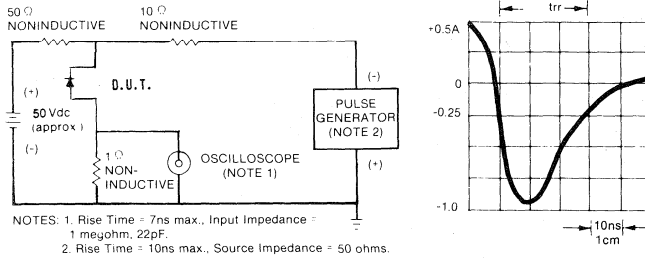

FIG. 2 — MAXIMUM AVERAGE FORWARD CURRENT RATING

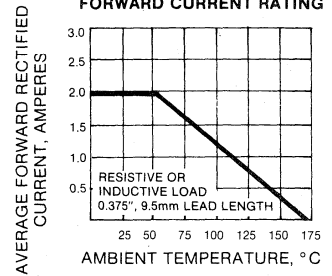

FIG. 3 — TYPICAL REVERSE CHARACTERISTICS

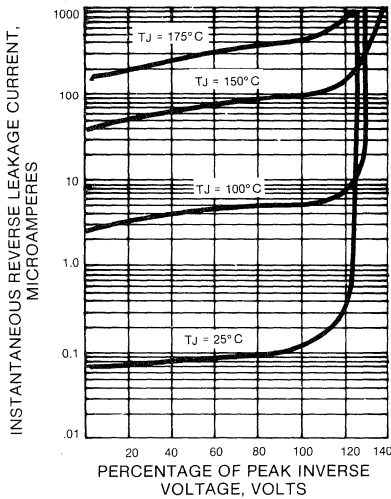

FIG. 4 — TYPICAL FORWARD CHARACTERISTICS

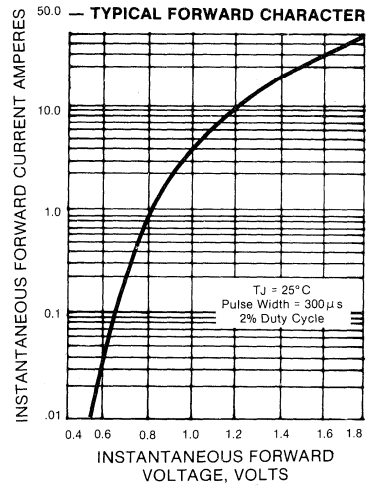

FIG. 5 — MAXIMUM NON-REPETITIVE PEAK FORWARD SURGE CURRENT

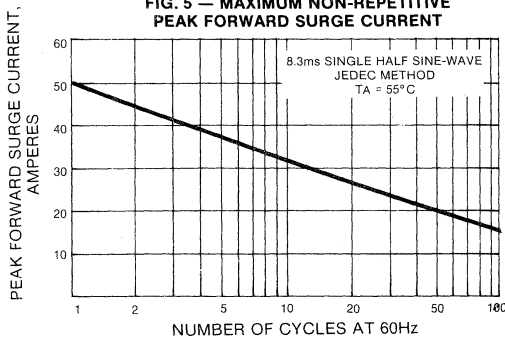
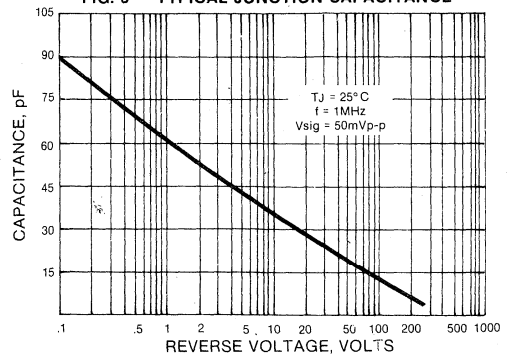

FIG. 6 — TYPICAL JUNCTION CAPACITANCE



BYV27-50 THRU BYV27-200

GLASS PASSIVATED FAST EPITAXIAL RECTIFIERS

Voltage - 50 to 200 Volts Current - 2.0 Amperes

FEATURES

- ◆ Glass passivated cavity-free junction
- ◆ Superfast recovery times-epitaxial construction
- ◆ Low forward voltage, high current capability
- ◆ Capable of meeting environmental standards of MIL-S-19500
- ◆ Hermetically sealed
- ◆ Low Leakage
- ◆ High surge capability
- ◆ High temperature metallurgically bonded, no compression contacts
- ◆ High temperature soldering guaranteed 350°C/10 seconds/.375", (9.5mm) lead length at 5 lbs., (2.3kg) tension

DO-204AP

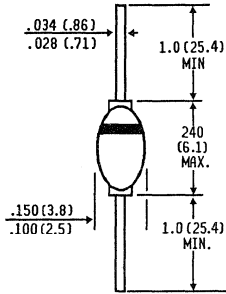

Dimensions in inches and (millimeters)

MECHANICAL DATA

Case: Unitized glass hermetically sealed

Terminals: Axial leads, solderable per MIL-STD-202, Method 208

Polarity: Color band denotes cathode

Mounting Position: Any

Weight: 0.02 ounce, 0.6 gram

MAXIMUM RATINGS AND ELECTRICAL CHARACTERISTICS

Ratings at 25°C ambient temperature unless otherwise specified.
Resistive or inductive load.
For capacitive load, derate current by 20%.

	SYMBOLS	BYV27-50	BYV27-100	BYV27-150	BYV27-200	UNITS
Maximum Recurrent Peak Reverse Voltage	V _{RRM}	50	100	150	200	Volts
Maximum RMS Voltage	V _{RMS}	35	70	105	140	Volts
Maximum DC Blocking Voltage	V _{DC}	50	100	150	200	Volts
Maximum Reverse Avalanche Voltage at 100 μA	V _{PK}	55	110	165	220	Volts
Maximum Average Forward Rectified Current .375", (9.5mm) Lead Lengths at T _L = 85°C	I _(AV)	2.0				Amps
Peak Forward Surge Current 10ms single half sine-wave superimposed on rated load (JEDEC Method) T _A = 175°C	I _{FSM}	50.0				Amps
Maximum Instantaneous Forward Voltage at 3.0A T _J = 175°C T _J = 25°C	V _F	1.07				Volts
Maximum DC Reverse Current at Rated DC Blocking Voltage T _A = 25°C T _A = 165°C	I _R	150.0				μA
Maximum Reverse Recovery Time (Note 1) T _J = 25°C	T _{RR}	25.0				Ns
Typical Junction Capacitance (Note 2)	C _J	45.0				pf
Typical Thermal Resistance (Note 3)	R _{θJL}	20				°C/W
Operating and Storage Temperature Range	T _J , T _{STG}	-65 to +175				°C

NOTES:

1. Reverse Recovery Test Conditions : I_F = 0.5A, I_R = 1.0A, recover to 0.25A.
2. Measured at 1.0 MHz and applied reverse voltage of 4.0 Volts.
3. Thermal Resistance from Junction to Lead at .375" (9.5mm) Lead Lengths.

RATINGS AND CHARACTERISTIC CURVES BYV27-50 THRU BYV27-200

FIG. 1 — REVERSE RECOVERY TIME CHARACTERISTIC AND TEST CIRCUIT DIAGRAM

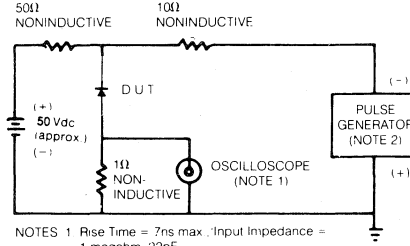

NOTES 1 Rise Time = 7ns max. Input Impedance = 1 megohm, 22pF
 2 Rise Time = 10ns max. Source Impedance = 50 ohms

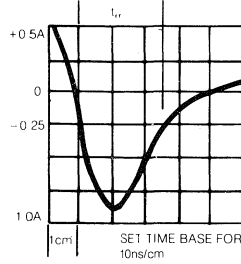

FIG. 2 — MAXIMUM AVERAGE FORWARD CURRENT

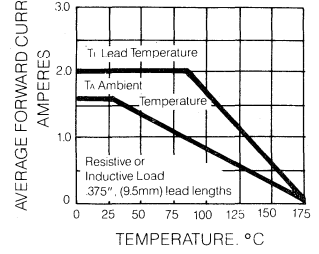

FIG. 3 — TYPICAL REVERSE CHARACTERISTICS

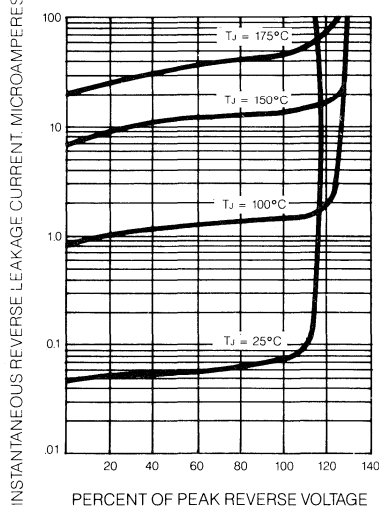

FIG. 4 — TYPICAL FORWARD CHARACTERISTICS

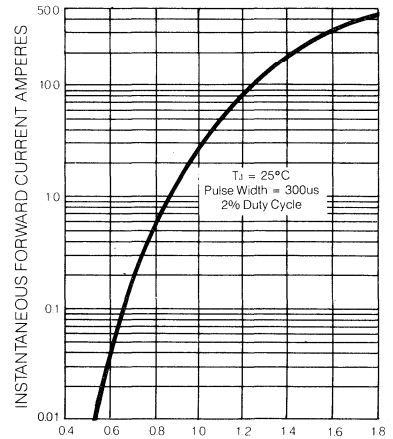

FIG. 5 — MAXIMUM NON-REPETITIVE PEAK FORWARD SURGE CURRENT

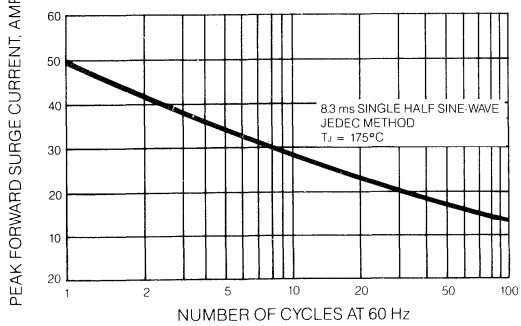
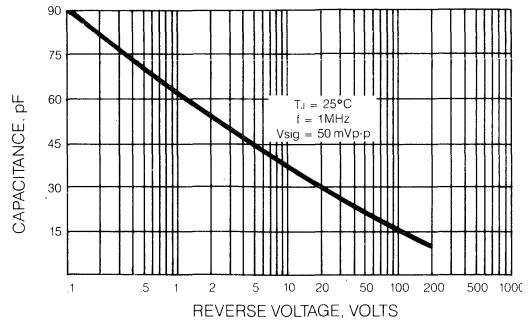

FIG. 6 — TYPICAL JUNCTION CAPACITANCE



GI1101 THRU GI1104

GLASS PASSIVATED FAST EFFICIENT RECTIFIER

Voltage - 50 to 200 Volts Current - 2.5 Amperes

FEATURES

PATENTED*

DO-204AP

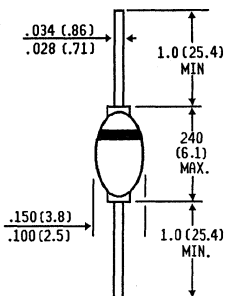

Dimensions in inches and (millimeters)

* Brazed-lead assembly is covered by Patent No. 3,930,306 of 1976 and glass composition by Patent No. 3,752,701 of 1973

- ◆ Glass passivated cavity-free junction
- ◆ Superfast recovery times-epitaxial construction
- ◆ Low forward voltage, high current capability
- ◆ Capable of meeting environmental standards of MIL-S-19500
- ◆ Hermetically sealed
- ◆ Low Leakage
- ◆ High surge capability
- ◆ High temperature metallurgically bonded, no compression contacts
- ◆ High temperature soldering guaranteed: 350°C/10 seconds/.375", (9.5mm) lead length at 5 lbs., (2.3kg) tension

MECHANICAL DATA

Case: Unitized glass hermetically sealed

Terminals: Axial leads, solderable per MIL-STD-202, Method 208

Polarity: Color band denotes cathode

Mounting Position: Any

Weight: 0.02 ounce, 0.6 gram

MAXIMUM RATINGS AND ELECTRICAL CHARACTERISTICS

Ratings at 25°C ambient temperature unless otherwise specified.
Resistive or inductive load.
For capacitive load, derate current by 20%.

	SYMBOLS	GI1101	GI1102	GI1103	GI1104	UNITS
Maximum Recurrent Peak Reverse Voltage	V_{RRM}	50	100	150	200	Volts
Maximum RMS Voltage	V_{RMS}	35	70	105	140	Volts
Maximum DC Blocking Voltage	V_{DC}	50	100	150	200	Volts
Maximum Average Forward Rectified Current .375", (9.5mm) Lead Lengths at $T_L = 75^\circ\text{C}$	$I_{(AV)}$	2.5			(Note 3) 2.0	Amps
Peak Forward Surge Current 10ms single half sine-wave superimposed on rated load (JEDEC Method)	I_{FSM}	50			20	Amps
Maximum Instantaneous Forward Voltage at 2.0A	V_F	.975			(Note 4) 1.25	Volts
Maximum DC Reverse Current $T_A = 25^\circ\text{C}$ at Rated DC Blocking Voltage $T_A = 100^\circ\text{C}$	I_R	2.0 50.0			10.0 200	μA
Maximum Reverse Recovery Time (Note 1)	T_{RR}	25			50	Ns
Typical Junction Capacitance (Note 2)	C	45.0				pf
Typical Thermal Resistance (Note 5)	$R_{\theta JL}$	20				$^\circ\text{C/W}$
Operating and Storage Temperature Range	T_J, T_{STG}	-65 to +175			-65 to +150	$^\circ\text{C}$

NOTES:

1. Reverse Recovery Test Conditions : $I_F = 0.5A$, $I_R = 1.0A$, recover to 0.25A.
2. Measured at 1.0 MHz and applied reverse voltage of 4.0 Volts.
3. $T_L = 55^\circ\text{C}$, .375" (9.5mm) Lead Length.
4. $I_{FM} = 1.0ADC$.
5. Thermal Resistance from Junction to Lead at .375" (9.5mm) Lead Lengths.

RATINGS AND CHARACTERISTIC CURVES GI1101 THRU GI1104

FIG. 1 — REVERSE RECOVERY TIME CHARACTERISTIC AND TEST DIAGRAM

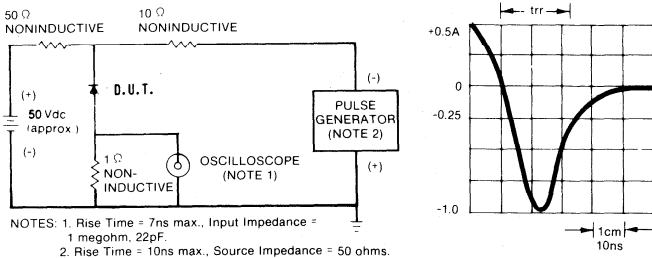

FIG. 2 — MAXIMUM AVERAGE FORWARD CURRENT RATING

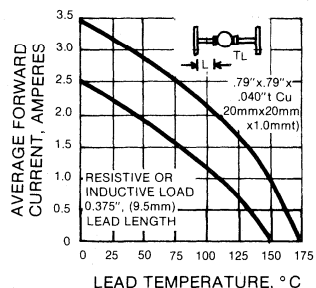

FIG. 3 — TYPICAL REVERSE CHARACTERISTICS

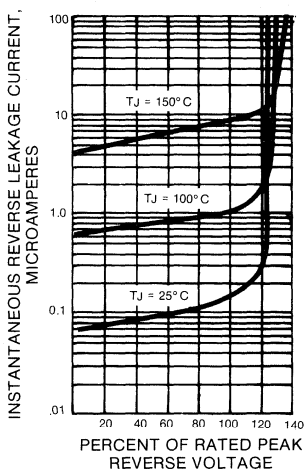

FIG. 4 — MAXIMUM NON-REPETITIVE PEAK FORWARD SURGE CURRENT

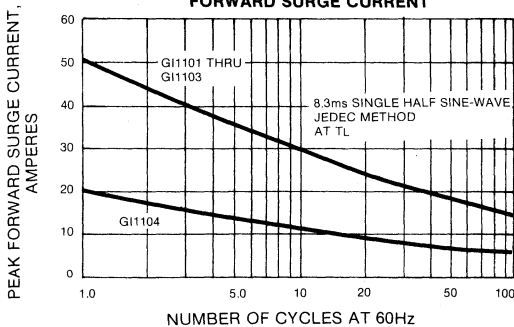

FIG. 5 — TYPICAL FORWARD CHARACTERISTICS

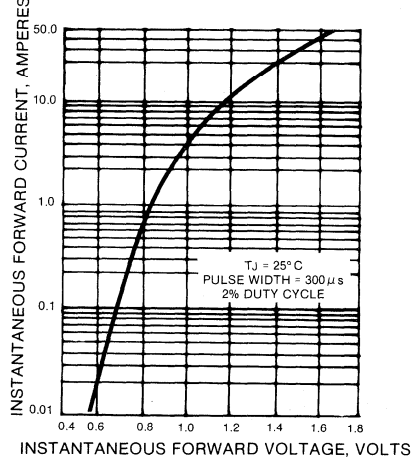
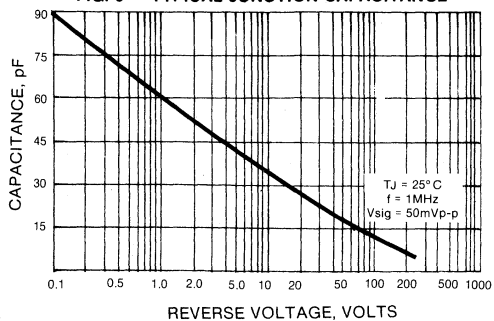

FIG. 6 — TYPICAL JUNCTION CAPACITANCE



FE3A THRU FE3D

GLASS PASSIVATED FAST EFFICIENT RECTIFIER

Voltage - 50 to 200 Volts Current - 3.0 Amperes

FEATURES

- ◆ Glass passivated cavity-free junction
- ◆ Superfast recovery times-epitaxial construction
- ◆ Low forward voltage, high current capability
- ◆ Capable of meeting environmental standards of MIL-S-19500
- ◆ Hermetically sealed
- ◆ Low Leakage
- ◆ High surge capability
- ◆ High temperature metallurgically bonded, no compression contacts
- ◆ High temperature soldering guaranteed: 350°C/10 seconds/.375", (9.5mm) lead length at 5 lbs., (2.3kg) tension

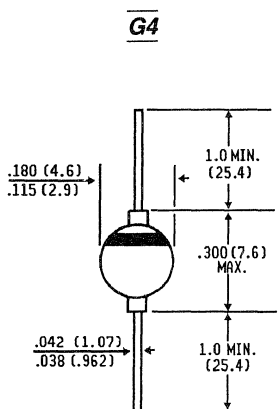

Dimensions in inches and (millimeters)

MECHANICAL DATA

Case: Unitized glass hermetically sealed

Terminals: Axial leads, solderable per MIL-STD-202, Method 208

Polarity: Color band denotes cathode

Mounting Position: Any

Weight: 0.037 ounce, 1.04 gram

MAXIMUM RATINGS AND ELECTRICAL CHARACTERISTICS

Ratings at 25°C ambient temperature unless otherwise specified.
Resistive or inductive load.
For capacitive load, derate current by 20%.

	SYMBOLS	FE3A	FE3B	FE3C	FE3D	UNITS
Maximum Recurrent Peak Reverse Voltage	V_{RRM}	50	100	150	200	Volts
Maximum RMS Voltage	V_{RMS}	35	70	105	140	Volts
Maximum DC Blocking Voltage	V_{DC}	50	100	150	200	Volts
Maximum Average Forward Rectified Current .375", (9.5mm) Lead Lengths at $T_A = 55^\circ\text{C}$	$I_{(AV)}$	3.0				Amps
Peak Forward Surge Current 8.3 ms single half sine-wave superimposed on rated load (JEDEC Method) $T_A = 55^\circ\text{C}$	I_{FSM}	125.0				Amps
Maximum Instantaneous Forward Voltage at 3.0A	V_F	0.95				Volts
Maximum DC Reverse Current $T_A = 25^\circ\text{C}$ at Rated DC Blocking Voltage $T_A = 150^\circ\text{C}$	I_R	50.0				μA
Maximum Reverse Recovery Time (Note 1) $T_J = 25^\circ\text{C}$	T_{RR}	35.0				Ns
Typical Junction Capacitance (Note 2)	C_J	100.0				p^f
Typical Thermal Resistance (Note 3)	$R_{\theta JA}$	55				$^\circ\text{C/W}$
Operating and Storage Temperature Range	T_J, T_{STG}	-65 to +175				$^\circ\text{C}$

NOTES:

1. Reverse Recovery Test Conditions : $I_F = 0.5\text{A}$, $I_R = 1.0\text{A}$, recover to 0.25A.
2. Measured at 1.0 MHz and applied reverse voltage of 4.0 Volts.
3. Thermal Resistance from Junction to Ambient at .375" (9.5mm) Lead Lengths.

RATINGS AND CHARACTERISTIC CURVES FE3A THRU FE3D

FIG. 1 — REVERSE RECOVERY TIME CHARACTERISTIC AND TEST DIAGRAM

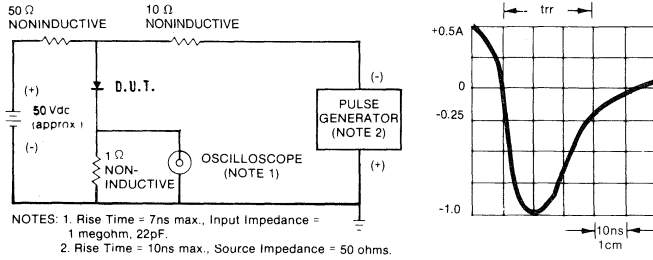

FIG. 2 — MAXIMUM AVERAGE FORWARD CURRENT RATING

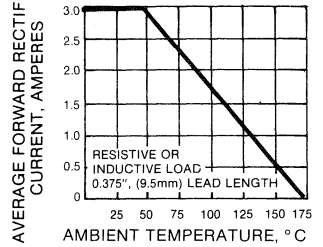

FIG. 3 — TYPICAL REVERSE CHARACTERISTICS

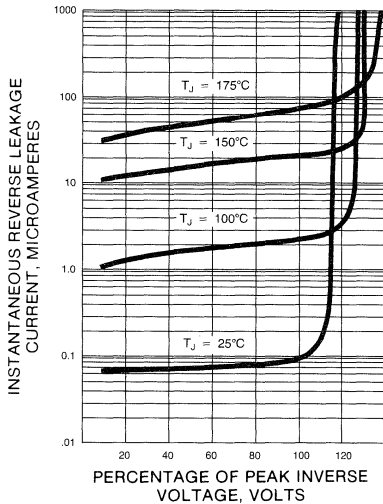

FIG. 4 — TYPICAL FORWARD CHARACTERISTICS

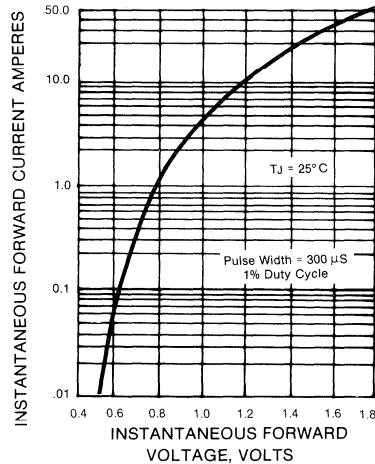

FIG. 5 — MAXIMUM NON-REPETITIVE PEAK FORWARD SURGE CURRENT

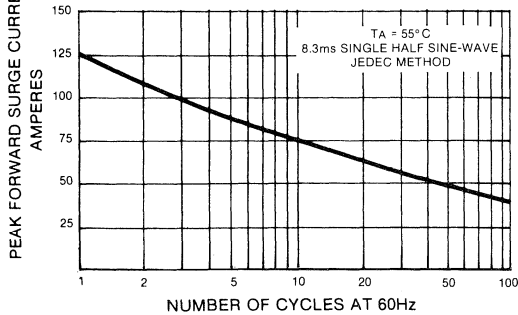
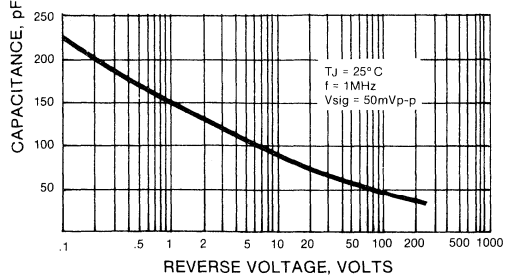

FIG. 6 — TYPICAL JUNCTION CAPACITANCE



BYV28-50 THRU BYV28-200

GLASS PASSIVATED FAST EPITAXIAL RECTIFIERS

Voltage - 50 to 200 Volts Current - 3.5 Amperes

FEATURES

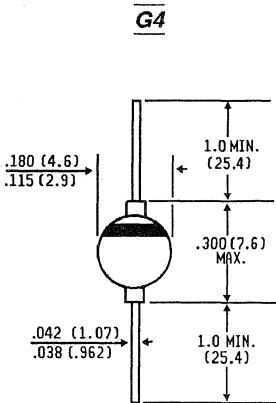

*Dimensions in inches
and
(millimeters)*

- ◆ Glass passivated cavity-free junction
- ◆ Superfast recovery times-epitaxial construction
- ◆ Low forward voltage, high current capability
- ◆ Capable of meeting environmental standards of MIL-S-19500
- ◆ Hermetically sealed
- ◆ Low Leakage
- ◆ High surge capability
- ◆ High temperature metallurgically bonded, no compression contacts
- ◆ High temperature soldering guaranteed 350°C/10 seconds/.375", (9.5mm) lead length at 5 lbs., (2.3kg) tension

MECHANICAL DATA

Case: Unitized glass hermetically sealed

Terminals: Axial leads, solderable per MIL-STD-202, Method 208

Polarity: Color band denotes cathode

Mounting Position: Any

Weight: 0.037 ounce, 7.04 gram

MAXIMUM RATINGS AND ELECTRICAL CHARACTERISTICS

Ratings at 25°C ambient temperature unless otherwise specified.
Resistive or inductive load.
For capacitive load, derate current by 20%.

	SYMBOLS	BYV28-50	BYV28-100	BYV28-150	BYV28-200	UNITS
Maximum Recurrent Peak Reverse Voltage	V _{RRM}	50	100	150	200	Volts
Maximum RMS Voltage	V _{RMS}	35	70	105	140	Volts
Maximum DC Blocking Voltage	V _{DC}	50	100	150	200	Volts
Maximum Reverse Avalanche Voltage at 100 μA	V _{PK}	55	110	165	220	Volts
Maximum Average Forward Rectified Current .375", (9.5mm) Lead Lengths at T _L = 85°C	I _(AV)	3.5				Amps
Peak Forward Surge Current 10ms single half sine-wave superimposed on rated load (JEDEC Method) T _A = 175°C	I _{FSM}	90				Amps
Maximum Instantaneous Forward Voltage at 3.0A T _J = 175°C T _J = 25°C	V _F	0.89 1.1				Volts
Maximum DC Reverse Current at Rated DC Blocking Voltage T _A = 25°C T _A = 165°C	I _R	1.0 150.0				μA
Maximum Reverse Recovery Time (Note 1) T _J = 25°C	T _{RR}	30.0				Ns
Typical Junction Capacitance (Note 2)	C	100				pf
Typical Thermal Resistance (Note 3)	R _{θJL}	20				°C/W
Operating and Storage Temperature Range	T _J , T _{STG}	-65 to +175				°C

NOTES:

1. Reverse Recovery Test Conditions : I_F = 0.5A, I_R = 1.0A, recover to 0.25A.
2. Measured at 1.0 MHz and applied reverse voltage of 4.0 Volts.
3. Thermal Resistance from Junction to Lead at .375" (9.5mm) Lead Lengths.

RATINGS AND CHARACTERISTIC CURVES BYV28-50 THRU BYV28-200

FIG. 1 — REVERSE RECOVERY TIME CHARACTERISTIC AND TEST CIRCUIT DIAGRAM

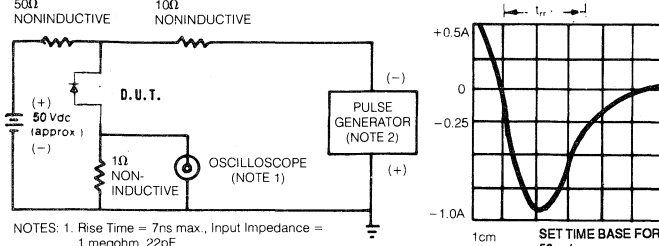

NOTES: 1. Rise Time = 7ns max., Input Impedance = 1 megohm, 22pF.
 2. Rise Time = 10ns max., Source Impedance = 50 ohms.

FIG. 2 — MAXIMUM AVERAGE FORWARD CURRENT

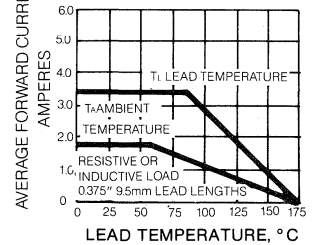

FIG. 3 — TYPICAL REVERSE CHARACTERISTICS

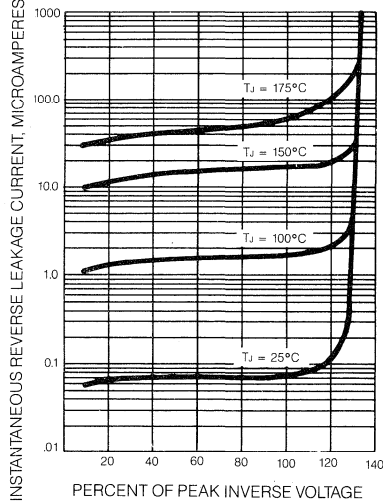

FIG. 4 — TYPICAL FORWARD CHARACTERISTICS

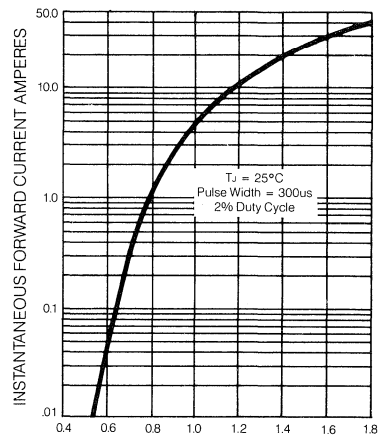

FIG. 5 — MAXIMUM NON-REPETITIVE PEAK FORWARD SURGE CURRENT

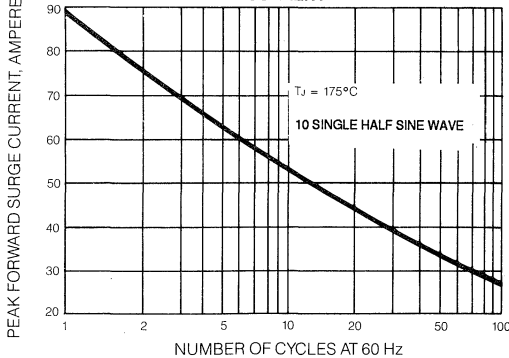
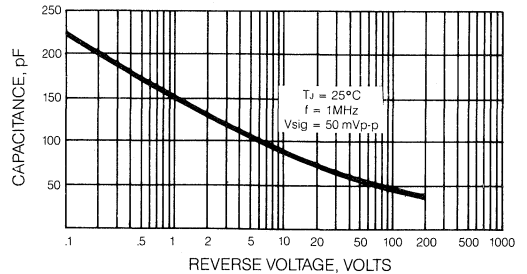

FIG. 6 — TYPICAL JUNCTION CAPACITANCE



FE5A THRU FE5D

GLASS PASSIVATED FAST EFFICIENT RECTIFIER

Voltage - 50 to 200 Volts Current - 5.0 Amperes

FEATURES

- ◆ Glass passivated cavity-free junction
- ◆ Superfast recovery times-epitaxial construction
- ◆ Low forward voltage, high current capability
- ◆ Capable of meeting environmental standards of MIL-S-19500
- ◆ Hermetically sealed
- ◆ Low Leakage
- ◆ High surge capability
- ◆ High temperature metallurgically bonded, no compression contacts
- ◆ High temperature soldering guaranteed 350°C/10 seconds/.375", (9.5mm) lead length at 5 lbs., (2.3kg) tension

PATENTED*

G4

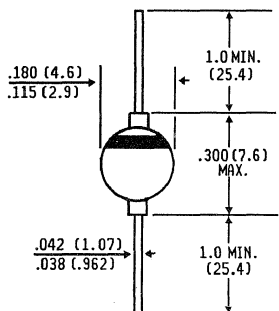

Dimensions in inches and (millimeters)

* Brazed-lead assembly is covered by Patent No. 3,930,306 of 1976 and glass composition by Patent No. 3,752,701 of 1973

MECHANICAL DATA

Case: Unitized glass hermetically sealed

Terminals: Axial leads, solderable per MIL-STD-202, Method 208

Polarity: Color band denotes cathode

Mounting Position: Any

Weight: 0.037 ounce, 1.04 gram

MAXIMUM RATINGS AND ELECTRICAL CHARACTERISTICS

Ratings at 25°C ambient temperature unless otherwise specified.

Resistive or inductive load.

For capacitive load, derate current by 20%.

	SYMBOLS	FE5A	FE5B	FE5C	FE5D	UNITS
Maximum Recurrent Peak Reverse Voltage	V_{RRM}	50	100	150	200	Volts
Maximum RMS Voltage	V_{RMS}	35	70	105	140	Volts
Maximum DC Blocking Voltage	V_{DC}	50	100	150	200	Volts
Maximum Average Forward Rectified Current .375", (9.5mm) Lead Lengths at $T_L = 55^\circ\text{C}$	$I_{(AV)}$	5.0				Amps
Peak Forward Surge Current 8.3ms single half sine-wave superimposed on rated load (JEDEC Method) $T_A = 55^\circ\text{C}$	I_{FSM}	135.0				Amps
Maximum Instantaneous Forward Voltage at 5.0A	V_F	0.95				Volts
Maximum DC Reverse Current $T_A = 25^\circ\text{C}$ at Rated DC Blocking Voltage $T_A = 150^\circ\text{C}$	I_R	50.0				μA
Maximum Reverse Recovery Time (Note 1) $T_J = 25^\circ\text{C}$	T_{RR}	35.0				Ns
Typical Junction Capacitance (Note 2)	C_J	100.0				pf
Typical Thermal Resistance (Note 3)	$R_{\theta JL}$	20				$^\circ\text{C/W}$
Operating and Storage Temperature Range	T_J, T_{STG}	-65 to +175				$^\circ\text{C}$

NOTES:

1. Reverse Recovery Test Conditions : $I_F = 0.5\text{A}$, $I_R = 1.0\text{A}$, recover to 0.25A.
2. Measured at 1.0 MHz and applied reverse voltage of 4.0 V_{DC}.
3. Thermal Resistance from Junction to Lead at .375" (9.5mm) Lead Lengths, P.C. Board Mounted.

RATINGS AND CHARACTERISTIC CURVES FE5A THRU FE5D

FIG. 1 — REVERSE RECOVERY TIME CHARACTERISTIC AND TEST DIAGRAM

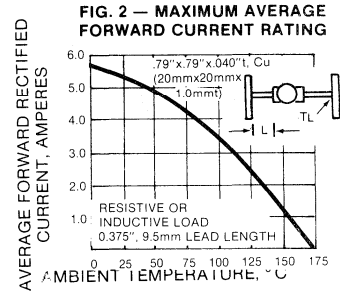
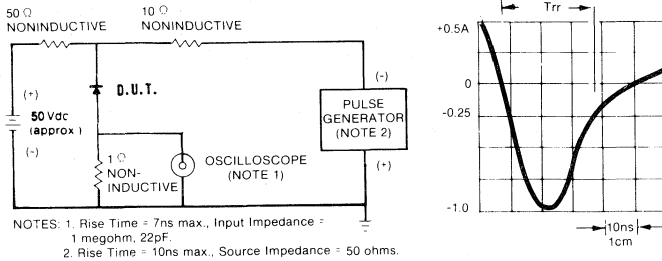

FIG. 3 — TYPICAL REVERSE CHARACTERISTICS

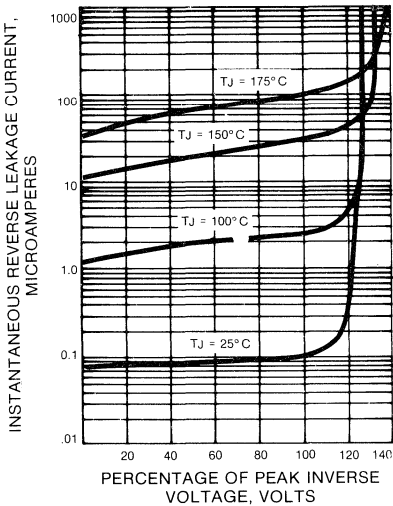

FIG. 4 — TYPICAL FORWARD CHARACTERISTICS

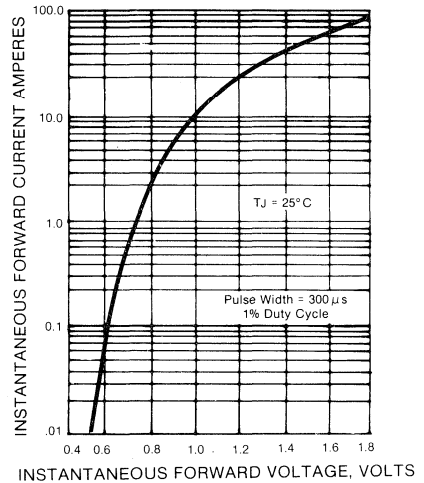

FIG. 5 — MAXIMUM NON-REPETITIVE PEAK FORWARD SURGE CURRENT

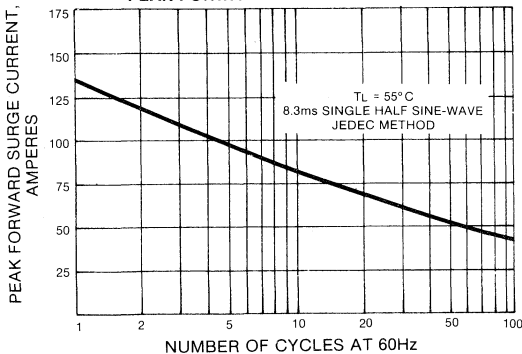
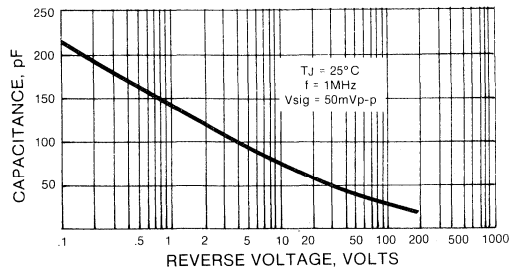

FIG. 6 — TYPICAL JUNCTION CAPACITANCE



FE6A THRU FE6D

GLASS PASSIVATED FAST EFFICIENT RECTIFIER

Voltage - 50 to 200 Volts Current - 6.0 Amperes

FEATURES

- ◆ Glass passivated cavity-free junction
- ◆ Superfast recovery times-epitaxial construction
- ◆ Low forward voltage, high current capability
- ◆ Capable of meeting environmental standards of MIL-S-19500
- ◆ Hermetically sealed
- ◆ Low Leakage
- ◆ High surge capability
- ◆ High temperature metallurgically bonded, no compression contacts
- ◆ High temperature soldering guaranteed 350°C/10 seconds/.375", (9.5mm) lead length at 5 lbs., (2.3kg) tension

PATENTED*

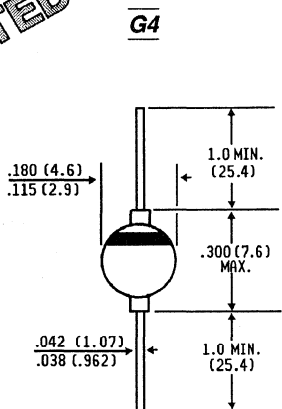

Dimensions in inches and (millimeters)

* Brazed - lead assembly is covered by Patent No. 3,930,306 of 1976 and glass composition by Patent No. 3,752,701 of 1973

MECHANICAL DATA

Case: Unitized glass hermetically sealed

Terminals: Axial leads, solderable per MIL-STD-202, Method 208

Polarity: Color band denotes cathode

Mounting Position: Any

Weight: 0.037 ounce, 1.04 gram

MAXIMUM RATINGS AND ELECTRICAL CHARACTERISTICS

Ratings at 25°C ambient temperature unless otherwise specified.

Resistive or inductive load.

For capacitive load, derate current by 20%.

	SYMBOLS	FE6A	FE6B	FE6C	FE6D	UNITS
Maximum Recurrent Peak Reverse Voltage	V _{RRM}	50	100	150	200	Volts
Maximum RMS Voltage	V _{RMS}	35	70	105	140	Volts
Maximum DC Blocking Voltage	V _{DC}	50	100	150	200	Volts
Maximum Average Forward Rectified Current .375", (9.5mm) Lead Lengths at T _L = 55°C	I _(AV)	6.0				Amps
Peak Forward Surge Current 8.3ms single half sine-wave superimposed on rated load (JEDEC Method) T _A = 55°C	I _{FSM}	150.0				Amps
Maximum Instantaneous Forward Voltage at 6.0A	V _F	0.975				Volts
Maximum DC Reverse Current T _A = 25°C at Rated DC Blocking Voltage T _A = 150°C	I _R	50.0				μA
Maximum Reverse Recovery Time (Note 1) T _J = 25°C	T _{RR}	35.0				Ns
Typical Junction Capacitance (Note 2)	C _J	100.0				pf
Typical Thermal Resistance (Note 3)	R _{θJL}	18.0				°C/W
Operating and Storage Temperature Range	T _J , T _{STG}	-65 to +175				°C

NOTES:

1. Reverse Recovery Test Conditions : I_F = 0.5A, I_R = 1.0A, recover to 0.25A.
2. Measured at 1.0 MHz and applied reverse voltage of 4.0 V_{DC}.
3. Thermal Resistance from Junction to Lead at .375" (9.5mm) Lead Lengths, P.C. Board Mounted.

RATINGS AND CHARACTERISTIC CURVES FE6A THRU FE6D

FIG. 1 — REVERSE RECOVERY TIME CHARACTERISTIC AND TEST DIAGRAM

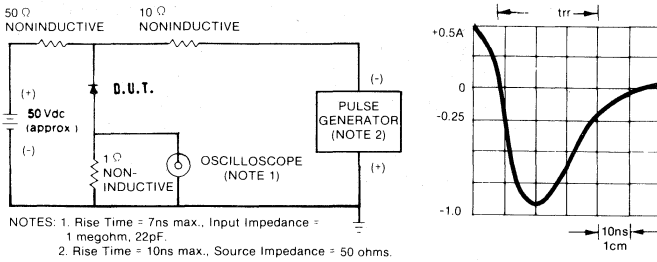

FIG. 2 — MAXIMUM AVERAGE FORWARD CURRENT RATING

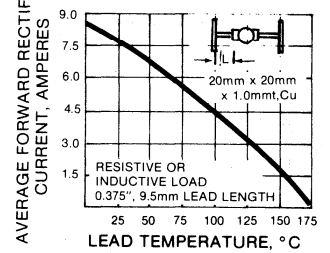

FIG. 3 — TYPICAL REVERSE CHARACTERISTICS

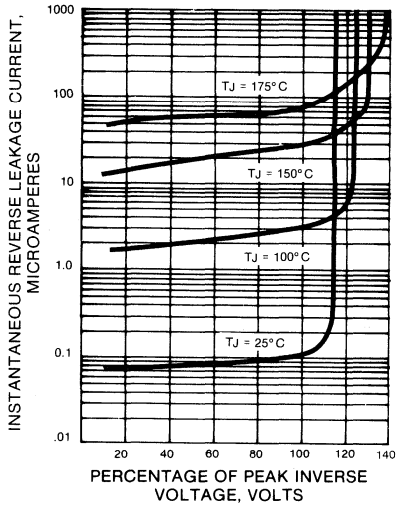

FIG. 4 — TYPICAL FORWARD CHARACTERISTICS

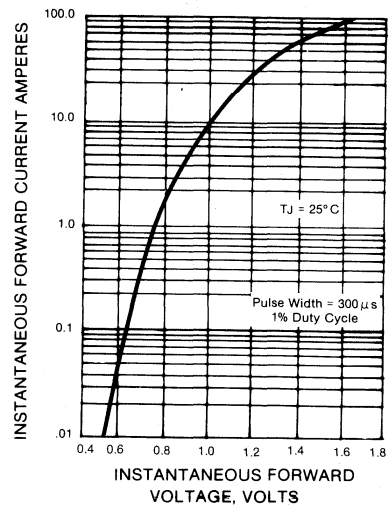

FIG. 5 — MAXIMUM NON-REPETITIVE PEAK FORWARD SURGE CURRENT

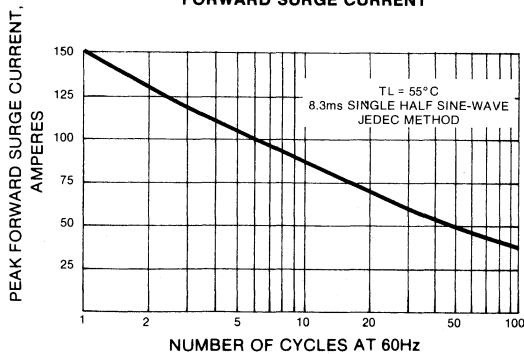
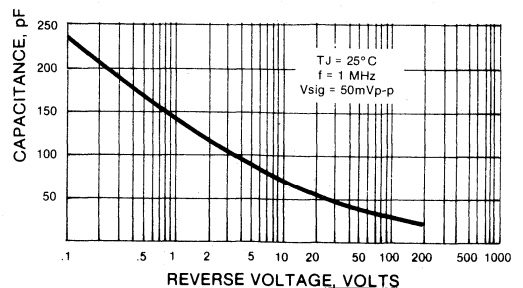

FIG. 6 — TYPICAL JUNCTION CAPACITANCE



GI1301 THRU GI1304

GLASS PASSIVATED FAST EFFICIENT RECTIFIER
Voltage - 50 to 200 Volts Current - 6.0 Amperes

FEATURES

PATENTED*

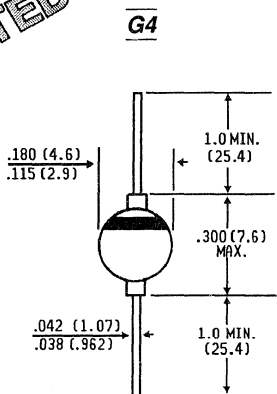

Dimensions in inches and (millimeters)

- ◆ Glass passivated cavity-free junction
- ◆ Superfast recovery times-epitaxial construction
- ◆ Low forward voltage, high current capability
- ◆ Capable of meeting environmental standards of MIL-S-19500
- ◆ Hermetically sealed
- ◆ Low Leakage
- ◆ High surge capability
- ◆ High temperature metallurgically bonded, no compression contacts
- ◆ High temperature soldering guaranteed 350°C/10 seconds/.375", (9.5mm) lead length at 5 lbs., (2.3kg) tension

MECHANICAL DATA

Case: Unitized glass hermetically sealed

Terminals: Axial leads, solderable per MIL-STD-202, Method 208

Polarity: Color band denotes cathode

Mounting Position: Any

Weight: 0.037 ounce, 1.04 gram

* Brazed - lead assembly is covered by Patent No. 3,930,306 of 1976 and glass composition by Patent No. 3,752,701 of 1973

MAXIMUM RATINGS AND ELECTRICAL CHARACTERISTICS

Ratings at 25°C ambient temperature unless otherwise specified.
 Resistive or inductive load.
 For capacitive load, derate current by 20%.

	SYMBOLS	GI1301	GI1302	GI1303	GI1304	UNITS
Maximum Recurrent Peak Reverse Voltage	V_{RRM}	50	100	150	200	Volts
Maximum RMS Voltage	V_{RMS}	35	70	105	140	Volts
Maximum DC Blocking Voltage	V_{DC}	50	100	150	200	Volts
Maximum Average Forward Rectified Current .375", (9.5mm) Lead Lengths at $T_L = 75^\circ C$	$I_{(AV)}$	6.0			(Note 3) 5.0	Amps
Peak Forward Surge Current 8.3ms single half sine-wave superimposed on rated load (JEDEC Method)	IFSM	150			70	Amps
Maximum Instantaneous Forward Voltage at 6.0A	V_F	0.925			(Note 4) 1.25	Volts
Maximum DC Reverse Current $T_A = 25^\circ C$ at Rated DC Blocking Voltage $T_A = 100^\circ C$	I_R	5.0 150.0			20.0 500	μA
Maximum Reverse Recovery Time (Note 1)	T_{RR}	30			50	Ns
Typical Junction Capacitance (Note 2)	C	95				pf
Typical Thermal Resistance (Note 5)	$R_{\theta JL}$	18				$^\circ C/W$
Operating and Storage Temperature Range	T_J, T_{STG}	-65 to +175			-65 to +150	$^\circ C$

NOTES:

1. Reverse Recovery Test Conditions : $I_F = 0.5A$, $I_R = 1.0A$, recover to 0.25A.
2. Measured at 1.0 MHz and applied reverse voltage of 4.0 Volts.
3. $T_L = 55^\circ C$, .375" (9.5mm) Lead Length.
4. IFM = 3.0ADC.
5. Thermal Resistance from Junction to Lead at .375" (9.5mm) Lead Lengths.

RATINGS AND CHARACTERISTIC CURVES GI1301 THRU GI1304

FIG. 1 — REVERSE RECOVERY TIME CHARACTERISTIC AND TEST CIRCUIT DIAGRAM

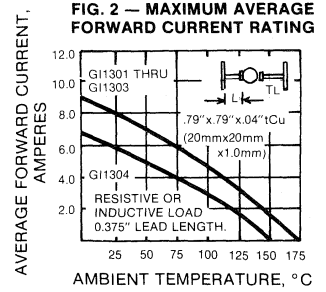
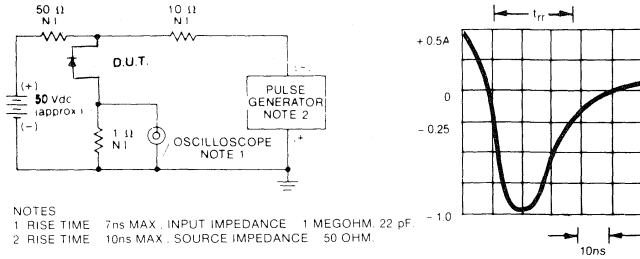

FIG. 3 — TYPICAL REVERSE CHARACTERISTICS

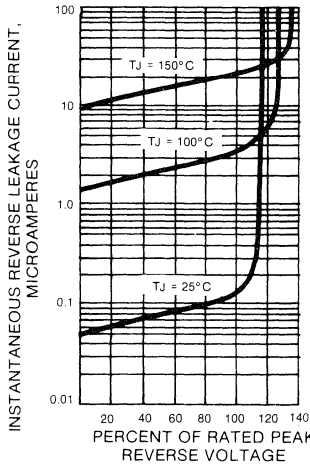

FIG. 5 — TYPICAL FORWARD CHARACTERISTICS

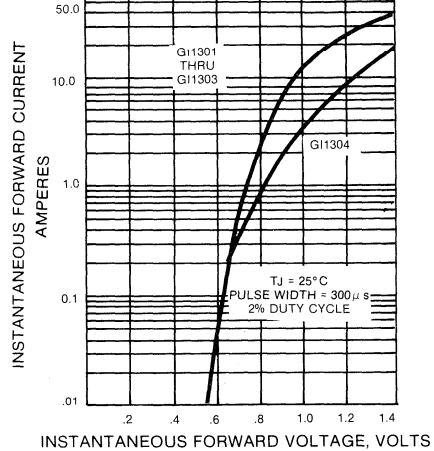

FIG. 4 — MAXIMUM NON-REPETITIVE PEAK FORWARD SURGE CURRENT

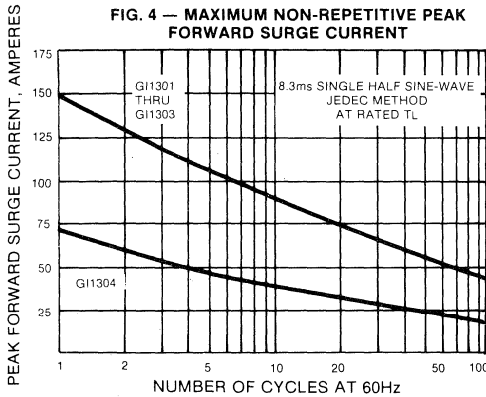
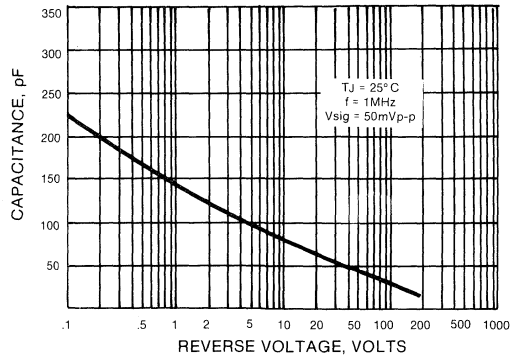

FIG. 6 — TYPICAL JUNCTION CAPACITANCE





**GLASS PASSIVATED
PLASTIC FAST EFFICIENT
RECTIFIERS**

1.0 AMPERE TO 5 AMPERES

**GENERAL
INSTRUMENT**

EGP10A THRU EGP10G

GLASS PASSIVATED JUNCTION FAST EFFICIENT RECTIFIER

Voltage - 50 to 400 Volts Current - 1.0 Amperes

FEATURES

- ◆ Glass passivated cavity-free junction
- ◆ Superfast recovery times for high efficiency
- ◆ Low forward voltage, high current capability
- ◆ Capable of meeting environmental standards of MIL-S-19500
- ◆ Low leakage
- ◆ High surge capability
- ◆ High temperature metallurgically bonded, no compression contacts
- ◆ Plastic package has Underwriters Laboratories Flammability Classification 94V-O
- ◆ High temperature soldering guaranteed 350°C/10 seconds/.375", (9.5mm) lead length at 5 lbs., (2.3kg) tension

PATENTED*

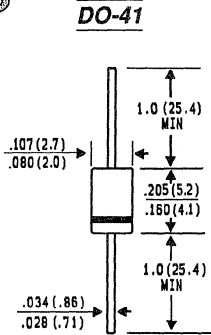

Dimensions in inches and (millimeters)

* Glass-plastic encapsulation technique is covered by Patent No. 3,996,602 of 1976; brazed-lead assembly to Patent No. 3,930,306 of 1976 and glass composition by Patent No. 3,752,701 of 1973

MECHANICAL DATA

- Case:** Moulded plastic over glass
Terminals: Axial leads, solderable per MIL-STD-202, Method 208
Polarity: Color band denotes cathode
Mounting Position: Any
Weight: 0.012 ounce, 0.3 gram



MAXIMUM RATINGS AND ELECTRICAL CHARACTERISTICS

Ratings at 25°C ambient temperature unless otherwise specified.
 Resistive or inductive load.
 For capacitive load, derate current by 20%.

	SYMBOLS	EGP 10A	EGP 10B	EGP 10C	EGP 10D	EGP 10F	EGP 10G	UNITS
Maximum Recurrent Peak Reverse Voltage	V _{RRM}	50	100	150	200	300	400	Volts
Maximum RMS Voltage	V _{RMS}	35	70	105	140	210	280	Volts
Maximum DC Blocking Voltage	V _{DC}	50	100	150	200	300	400	Volts
Maximum Average Forward Rectified Current .375", (9.5mm) Lead Lengths at T _A = 55°C	I _(AV)	1.0						Amps
Peak Forward Surge Current 8.3 ms single half sine-wave superimposed on rated load T _A = 55°C	I _{FSM}	30.0						Amps
Maximum Instantaneous Forward Voltage a 1.0A	V _F	0.95				1.25		Volts
Maximum DC Reverse Current T _A = 25°C at Rated DC Blocking Voltage T _A = 150°C	I _R	5.0				50.0		µA
Typical Reverse Recovery Time (Note 1) T _J = 25°C	T _{RR}	50.0						Ns
Typical Junction Capacitance (Note 2)	C _J	20.0				10.0		pf
Operating and Storage Temperature Range	T _J , T _{STG}	-65 to +150						°C

NOTES:

1. Reverse Recovery Test Conditions : I_F = .5A, I_R = 1A, I_{rr} = .25A.
2. Measured at 1.0 MHz and applied reverse voltage of 4.0 Volts.

RATINGS AND CHARACTERISTIC CURVES EGP10A THRU EGP10G

FIG. 1 — REVERSE RECOVERY TIME CHARACTERISTIC AND TEST DIAGRAM

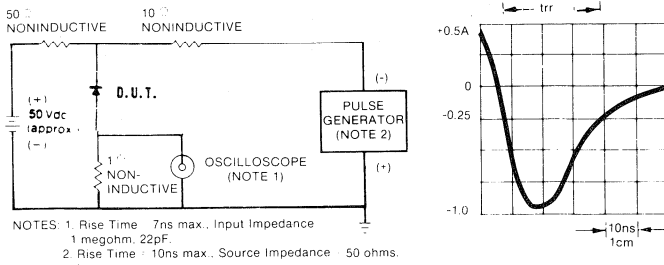

FIG. 2 — MAXIMUM AVERAGE FORWARD CURRENT RATING

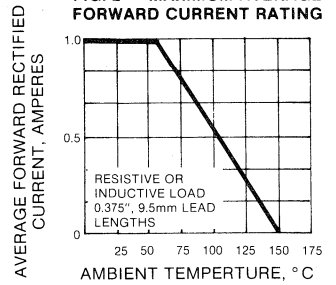

FIG. 3 — TYPICAL REVERSE CHARACTERISTICS

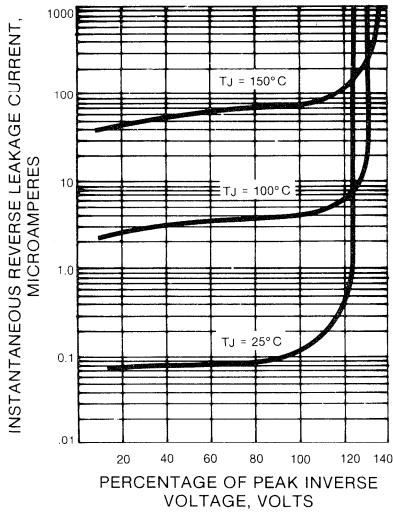

FIG. 4 — TYPICAL FORWARD CHARACTERISTICS

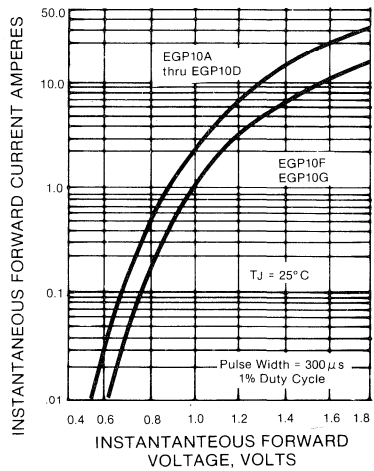

FIG. 5 — MAXIMUM NON-REPETITIVE PEAK FORWARD SURGE CURRENT

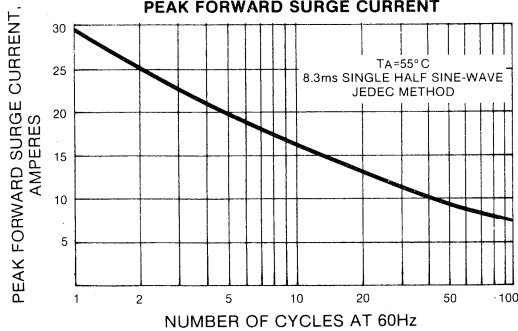
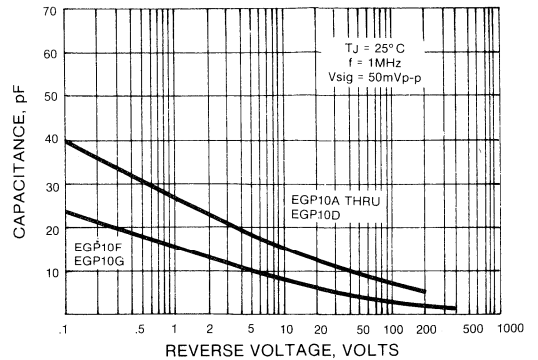

FIG. 6 — TYPICAL JUNCTION CAPACITANCE



EGP20A THRU EGP20G

GLASS PASSIVATED FAST EFFICIENT RECTIFIER

Voltage - 50 to 400 Volts Current - 2.0 Amperes

FEATURES

PATENTED*

DO-15

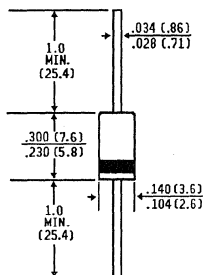

Dimensions in inches and (millimeters)

* Glass-plastic encapsulation technique is covered by Patent No. 3,996,602 of 1976; brazed-lead assembly to Patent No. 3,930,306 of 1976 and glass composition by Patent No. 3,752,701 of 1973



- ◆ Glass passivated cavity-free junction
- ◆ Superfast recovery times for high efficiency
- ◆ Low forward voltage, high current capability
- ◆ Capable of meeting environmental standards of MIL-S-19500
- ◆ Low leakage
- ◆ High surge capability
- ◆ High temperature metallurgically bonded, no compression contacts
- ◆ Plastic package has Underwriters Laboratories Flammability Classification 94V-O
- ◆ High temperature soldering guaranteed 350°C/10 seconds/.375", (9.5mm) lead length at 5 lbs., (2.3kg) tension

MECHANICAL DATA

Case: Molded plastic over glass

Terminals: Axial leads, solderable per MIL-STD-202, Method 208

Polarity: Color band denotes cathode

Mounting Position: Any

Weight: 0.015 ounce, 0.4 gram

MAXIMUM RATINGS AND ELECTRICAL CHARACTERISTICS

Ratings at 25°C ambient temperature unless otherwise specified.
Resistive or inductive load.
For capacitive load, derate current by 20%.

	SYMBOLS	EGP 20A	EGP 20B	EGP 20C	EGP 20D	EGP 20F	EGP 20G	UNITS
Maximum Recurrent Peak Reverse Voltage	V _{RRM}	50	100	150	200	300	400	Volts
Maximum RMS Voltage	V _{RMS}	35	70	105	140	210	280	Volts
Maximum DC Blocking Voltage	V _{DC}	50	100	150	200	300	400	Volts
Maximum Average Forward Rectified Current .375", (9.5mm) Lead Lengths at T _A = 55°C	I _(AV)	2.0						Amps
Peak Forward Surge Current 8.3 ms single half sine-wave superimposed on rated load T _A = 55°C	I _{FSM}	75.0						Amps
Maximum Instantaneous Forward Voltage at 2.0A	V _F	0.95			1.25			Volts
Maximum DC Reverse Current T _A = 25°C at Rated DC Blocking Voltage T _A = 150°C	I _R	5.0 50.0						μA
Typical Reverse Recovery Time (Note 1) T _J = 25°C	T _{RR}	50.0						Ns
Typical Junction Capacitance (Note 2)	C _J	70.0			40.0			pf
Operating and Storage Temperature Range	T _J , T _{STG}	-65 to +150						°C

NOTES:

1. Reverse Recovery Test Conditions : I_F = .5A, I_R = 1A, I_{rr} = .25A.
2. Measured at 1.0 MHz and applied reverse voltage of 4.0 Volts.

RATINGS AND CHARACTERISTIC CURVES EGP20A THRU EGP20G

FIG. 1 — REVERSE RECOVERY TIME CHARACTERISTIC AND TEST DIAGRAM

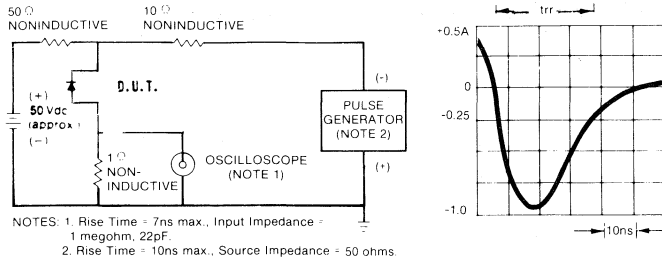

FIG. 2 — MAXIMUM AVERAGE FORWARD CURRENT RATING

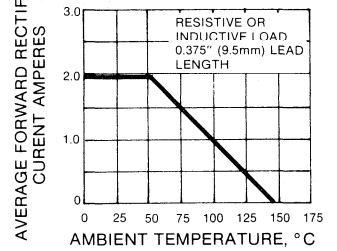

FIG. 3 — TYPICAL REVERSE CHARACTERISTICS

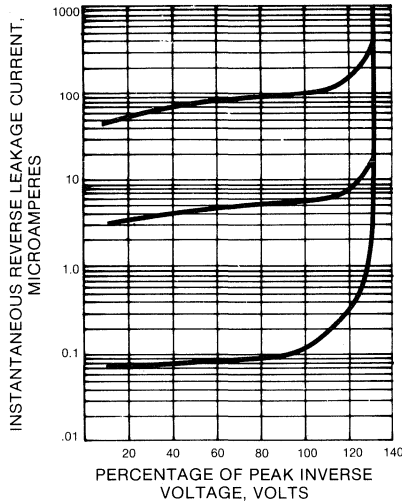

FIG. 4 — TYPICAL FORWARD CHARACTERISTICS

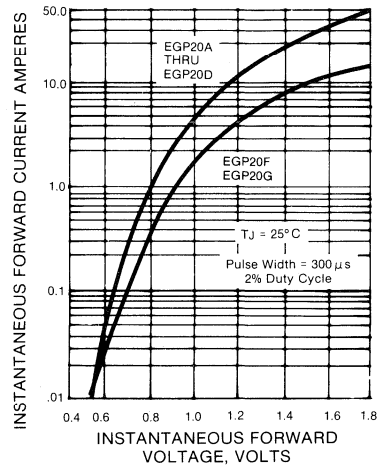

FIG. 5 — MAXIMUM NON-REPETITIVE SURGE CURRENT

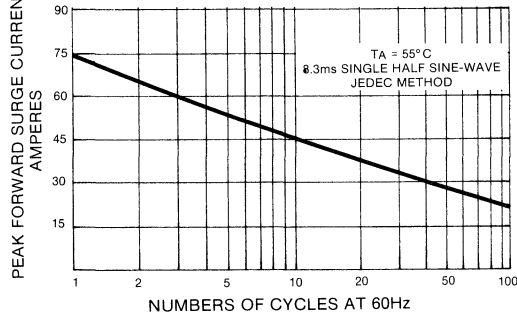
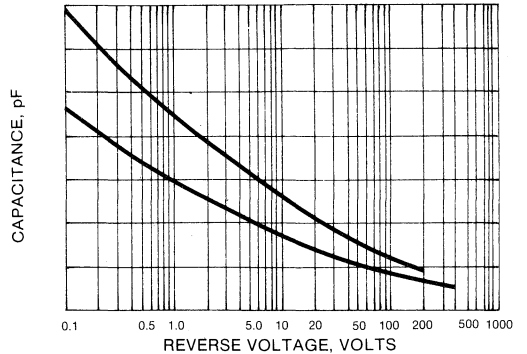

FIG. 6 — TYPICAL JUNCTION CAPACITANCE



EGP30A THRU EGP30G

GLASS PASSIVATED FAST EFFICIENT RECTIFIER
Voltage - 50 to 400 Volts Current - 3.0 Amperes

FEATURES

PATENTED*

GP-20

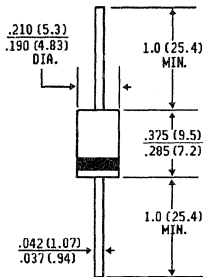

Dimensions in inches and (millimeters)

* Glass-plastic encapsulation technique is covered by Patent No. 3,996,602 of 1976; brazed-lead assembly to Patent No. 3,930,306 of 1976 and glass composition by Patent No. 3,752,701 of 1973



MAXIMUM RATINGS AND ELECTRICAL CHARACTERISTICS

Ratings at 25°C ambient temperature unless otherwise specified.
 Resistive or inductive load.
 For capacitive load, derate current by 20%.

	SYMBOLS	EGP 30A	EGP 30B	EGP 30C	EGP 30D	EGP 30F	EGP 30G	UNITS
Maximum Recurrent Peak Reverse Voltage	V _{RRM}	50	100	150	200	300	400	Volts
Maximum RMS Voltage	V _{RMS}	35	70	105	140	210	280	Volts
Maximum DC Blocking Voltage	V _{DC}	50	100	150	200	300	400	Volts
Maximum Average Forward Rectified Current .375", (9.5mm) Lead Lengths at T _A = 55°C	I _(AV)	3.0						Amps
Peak Forward Surge Current 8.3 ms single half sine-wave superimposed on rated load T _A = 55°C	I _{FSM}	125.0						Amps
Maximum Instantaneous Forward Voltage a 3.0A	V _F	0.95			1.25			Volts
Maximum DC Reverse Current T _A = 25°C at Rated DC Blocking Voltage T _A = 150°C	I _R	50.0						µA
Typical Reverse Recovery Time (Note 1) T _J = 25°C	T _{RR}	50.0						ns
Typical Junction Capacitance (Note 2)	C _J	90.0			55.0			pf
Operating and Storage Temperature Range	T _J , T _{STG}	-65 to +150						°C

NOTES:

- Reverse Recovery Test Conditions : I_F = .5A, I_R = 1A, I_{RR} = .25A.
- Measured at 1.0 MHz and applied reverse voltage of 4.0 Volts.

- ◆ Glass passivated cavity-free junction
- ◆ Superfast recovery times for high efficiency
- ◆ Low forward voltage, high current capability
- ◆ Capable of meeting environmental standards of MIL-S-19500
- ◆ Low leakage
- ◆ High surge capability
- ◆ High temperature metallurgically bonded, no compression contacts
- ◆ Plastic package has Underwriters Laboratories Flammability Classification 94V-O
- ◆ High temperature soldering guaranteed 350°C/10 seconds/.375", (9.5mm) lead length at 5 lbs., (2.3kg) tension

MECHANICAL DATA

Case: Molded plastic over glass

Terminals: Axial leads, solderable per MIL-STD-202, Method 208

Polarity: Color band denotes cathode

Mounting Position: Any

Weight: 0.03 ounce, 0.8 gram

RATINGS AND CHARACTERISTIC CURVES EGP30A THRU EGP30G

FIG. 1 — REVERSE RECOVERY TIME CHARACTERISTIC AND TEST DIAGRAM

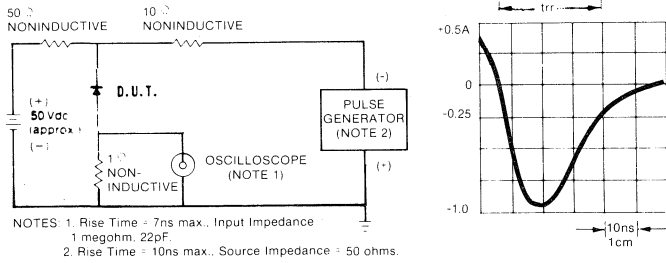

FIG. 2 — MAXIMUM AVERAGE FORWARD CURRENT RATING

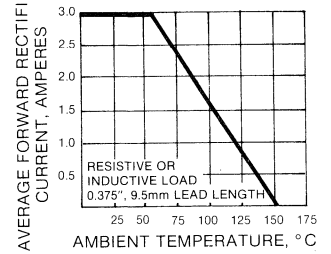

FIG. 3 — TYPICAL REVERSE CHARACTERISTICS

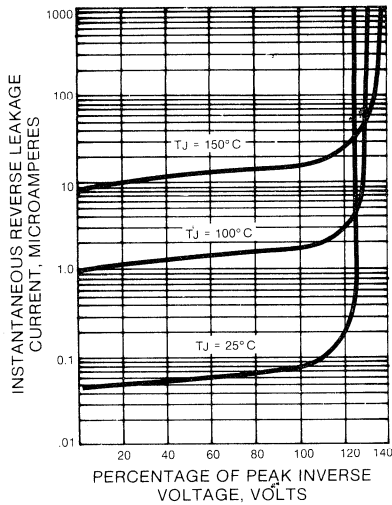

FIG. 4 — TYPICAL FORWARD CHARACTERISTICS

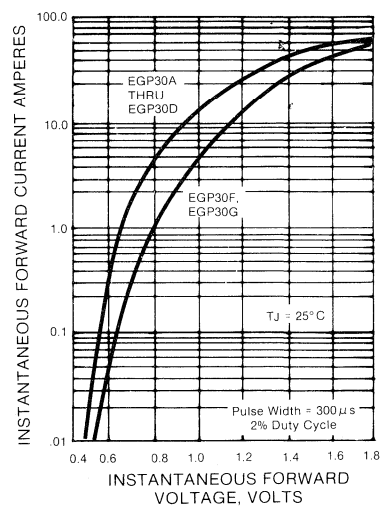

FIG. 5 — MAXIMUM NON-REPETITIVE PEAK FORWARD SURGE CURRENT

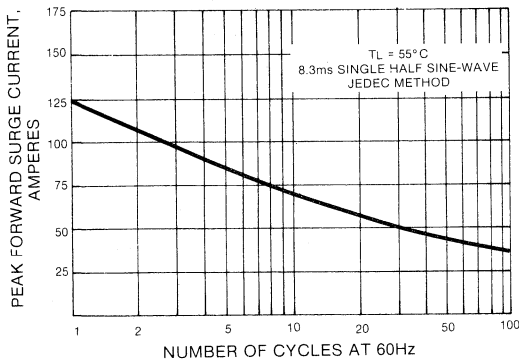
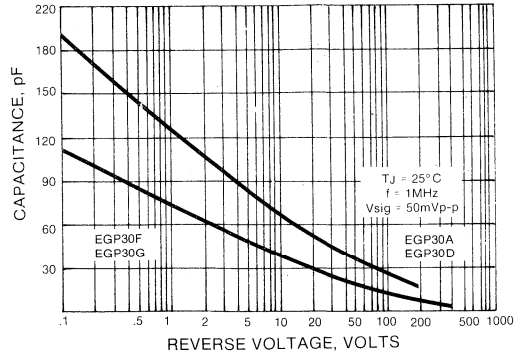

FIG. 6 — TYPICAL JUNCTION CAPACITANCE



EGP50A THRU EGP50G

GLASS PASSIVATED FAST EFFICIENT RECTIFIER
Voltage - 50 to 400 Volts Current - 5.0 Amperes

FEATURES

PATENTED*

GP-20

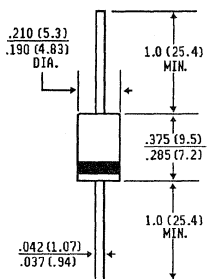

Dimensions in inches and (millimeters)

* Glass-plastic encapsulation technique is covered by Patent No. 3,996,602 of 1976; brazed-lead assembly to Patent No. 3,930,306 of 1976 and glass composition by Patent No. 3,752,701 of 1973



MAXIMUM RATINGS AND ELECTRICAL CHARACTERISTICS

Ratings at 25°C ambient temperature unless otherwise specified.
 Resistive or inductive load.
 For capacitive load, derate current by 20%.

	SYMBOLS	EGP 50A	EGP 50B	EGP 50C	EGP 50D	EGP 50F	EGP 50G	UNITS
Maximum Recurrent Peak Reverse Voltage	V _{RRM}	50	100	150	200	300	400	Volts
Maximum RMS Voltage	V _{RMS}	35	70	105	140	210	280	Volts
Maximum DC Blocking Voltage	V _{DC}	50	100	150	200	300	400	Volts
Maximum Average Forward Rectified Current .375", (9.5mm) Lead Lengths at T _L = 55°C	I _(AV)	5.0						Amps
Peak Forward Surge Current 8.3 ms single half sine-wave superimposed on rated load T _L = 55°C	I _{FSM}	150.0						Amps
Maximum Instantaneous Forward Voltage a 5.0A	V _F	0.95			1.25			Volts
Maximum DC Reverse Current T _A = 25°C at Rated DC Blocking Voltage T _A = 150°C	I _R	5.0						µA
Typical Reverse Recovery Time (Note 1) T _J = 25°C	T _{RR}	50.0						Ns
Maximum Thermal Resistance (Note 3)	R _{ΘJ L}	20						°C/W
Typical Junction Capacitance (Note 2)	C _J	100						pf
Operating and Storage Temperature Range	T _{J, TSTG}	-65 to +150						°C

NOTES: 1. Reverse Recovery Test Conditions : I_F = .5A, I_R = 1A, I_{rr} = .25A.
 2. Measured at 1.0 MHz and applied reverse voltage of 4.0 Volts.
 3. Thermal Resistance from Junction to Lead at .375", 9.5mm Lead Lengths.

- ◆ Glass passivated cavity-free junction
- ◆ Superfast recovery times for high efficiency
- ◆ Low forward voltage, high current capability
- ◆ Capable of meeting environmental standards of MIL-S-19500
- ◆ Low leakage
- ◆ High surge capability
- ◆ High temperature metallurgically bonded, no compression contacts
- ◆ Plastic package has Underwriters Laboratories Flammability Classification 94V-0
- ◆ High temperature soldering guaranteed: 350°C/10 seconds/.375", (9.5mm) lead length at 5 lbs., (2.3kg) tension

MECHANICAL DATA

Case: Molded plastic over glass

Terminals: Axial leads, solderable per MIL-STD-202, Method 208

Polarity: Color band denotes cathode

Mounting Position: Any

Weight: 0.03 ounce, 0.8 gram

RATINGS AND CHARACTERISTIC CURVES EGP50A THRU EGP50G

FIG. 1 — REVERSE RECOVERY TIME CHARACTERISTIC AND TEST DIAGRAM

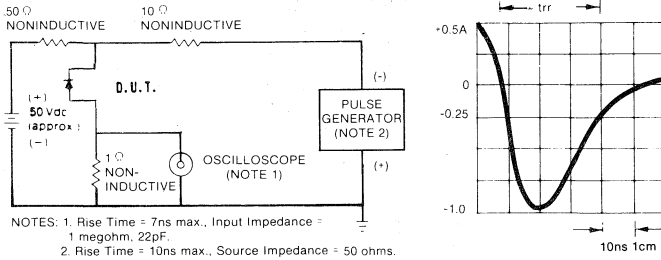

FIG. 2 — MAXIMUM AVERAGE FORWARD CURRENT RATING

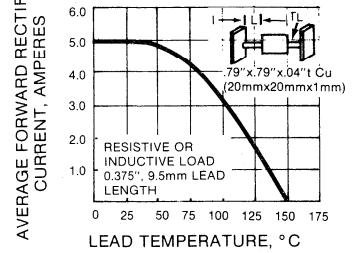

FIG. 3 — TYPICAL REVERSE CHARACTERISTICS

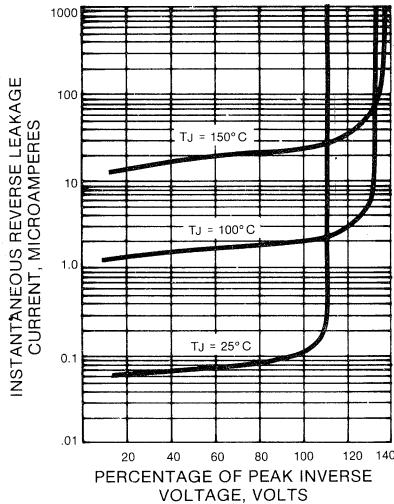

FIG. 5 — MAXIMUM NON-REPETITIVE PEAK FORWARD SURGE CURRENT

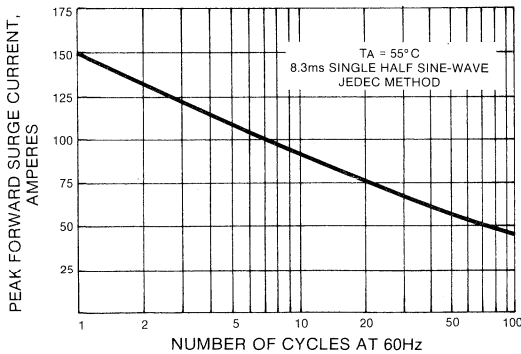

FIG. 4 — TYPICAL FORWARD CHARACTERISTICS

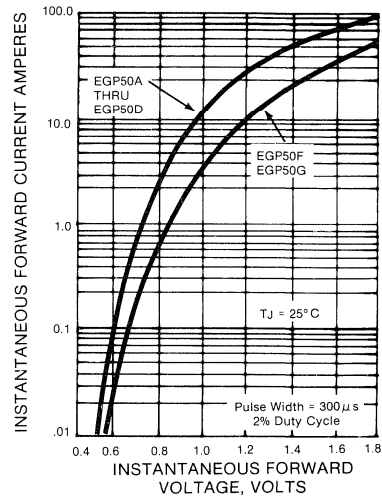
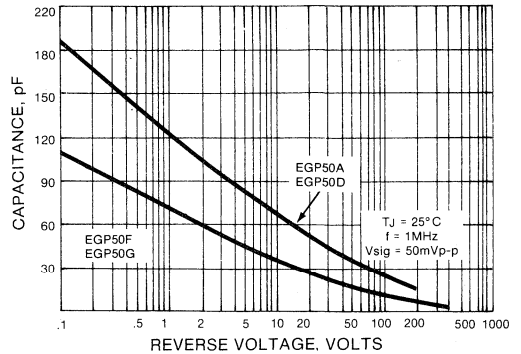

FIG. 6 — TYPICAL JUNCTION CAPACITANCE



**PLASTIC FAST EFFICIENT
RECTIFIERS**

1 AND 3 AMPERES

**GENERAL
INSTRUMENT**

UF4001 THRU UF4007

ULTRAFAST MINIATURE PLASTIC SILICON RECTIFIER
VOLTAGE - 50 to 1000 Volts CURRENT - 1.0 Ampere

FEATURES

- ◆ The plastic package carries Underwriters Laboratory Flammability Classification 94V-O
- ◆ 1.0 Ampere operation at TA = 55°C with no thermal runaway
- ◆ Low cost
- ◆ Ultrafast Recovery Times for high efficiency
- ◆ Low Forward Voltage
- ◆ Low Leakage
- ◆ High Surge Capability
- ◆ High temperature soldering guaranteed 375°C/10 seconds/.375", (9.5mm) lead lengths at 5 lbs., (2.3kg) tension

DO-41

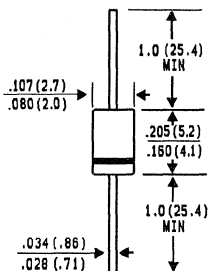

Dimensions in inches and (millimeters)

MECHANICAL DATA

Case: JEDEC DO-41 Molded plastic

Terminals: Axial leads, solderable per MIL-STD-202, Method 208

Polarity: Color band denotes Cathode End

Weight: 0.012 ounce, 0.3 gram

Mounting Position: Any

MAXIMUM RATINGS AND ELECTRICAL CHARACTERISTICS

Ratings at 25°C ambient temperature unless otherwise specified
 Resistive or inductive load.
 For capacitive load, derate current by 20%.

	UF	UF	UF	UF	UF	UF	UF		
	SYMBOLS	4001	4002	4003	4004	4005	4006	4007	UNITS
Maximum Recurrent Peak Reverse Voltage	V _{RRM}	50	100	200	400	600	800	1000	Volts
Maximum RMS Voltage	V _{RMS}	35	70	140	280	420	560	700	Volts
Maximum DC Blocking Voltage	V _{DC}	50	100	200	400	600	800	1000	Volts
Maximum Average Forward Rectified Current .375" (9.5mm) Lead Length T _A = 55°C	I _(AV)	1.0							Amps
Peak Forward Surge Current 8.3ms single half sine-wave superimposed on rated load (JEDEC Method)	I _{FSM}	30.0							Amps
Maximum Instantaneous Forward Voltage at 1.0A	V _F	1.0			1.4				Volts
Maximum DC Reverse Current T _A = 25°C at Rated DC Blocking Voltage T _A = 100°C	I _R	10.0							μA
		50.0							
Maximum Reverse Recovery Time (Note 1) T _J = 25°C	T _{rr}	50.0			75.0				Ns
Typical Junction Capacitance (Note 2)	C _J	20			15				pF
Typical Thermal Resistance (Note 3)	R _{θJA}	25.0							°C/W
Operating and Storage Temperature Range,	T _J , T _{STG}	-65 to +150							°C

NOTES:

1. Reverse Recovery Test Conditions: I_F = .5A, I_R = 1A, I_{rr} = .25A.
2. Measured at 1 MHz and applied reverse voltage of 4.0 Volts.
3. Thermal Resistance from Junction to Ambient, .375", 9.5mm Lead Lengths.

RATINGS AND CHARACTERISTIC CURVES UF4001 THRU UF4007

FIG. 1 — MAXIMUM AVERAGE FORWARD CURRENT RATING

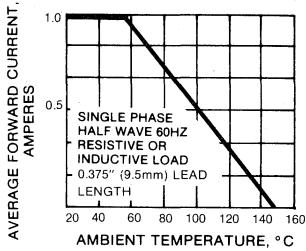

FIG. 2 — TYPICAL FORWARD CHARACTERISTICS

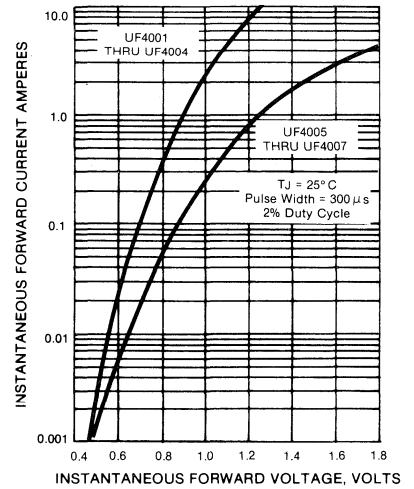

FIG. 3 — TYPICAL REVERSE CHARACTERISTICS

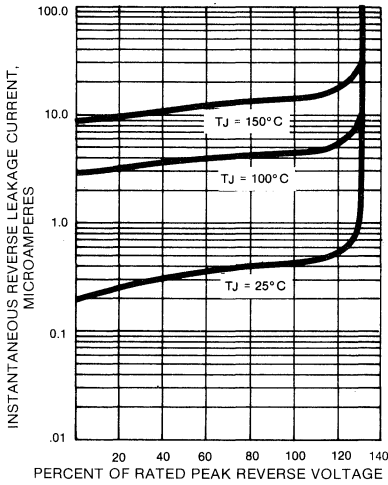

FIG. 4 — MAXIMUM NON-REPETITIVE PEAK FORWARD SURGE CURRENT

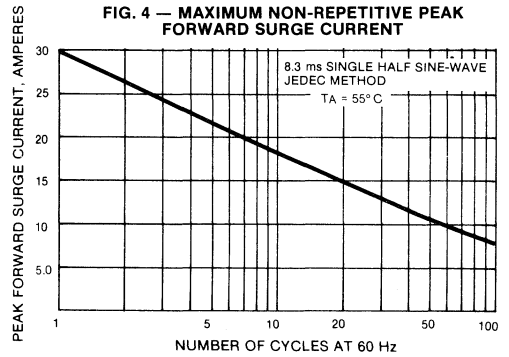

FIG. 6 — TYPICAL JUNCTION CAPACITANCE

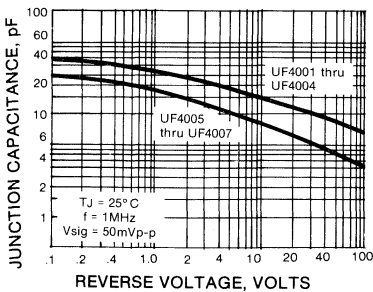
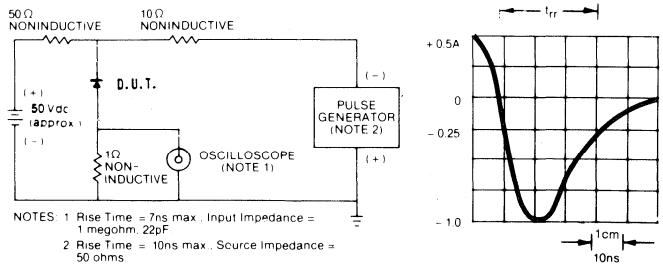

FIG. 5 — REVERSE RECOVERY TIME CHARACTERISTIC AND TEST CIRCUIT DIAGRAM



UF5400 THRU UF5408

ULTRAFAST PLASTIC SILICON RECTIFIER

Voltage - 50 to 1000 Volts Current - 3.0 Amperes

FEATURES

- ◆ Low cost
- ◆ Ultrafast recovery times for high efficiency
- ◆ Low forward voltage, high current capability
- ◆ Low leakage
- ◆ High surge capability
- ◆ Plastic material used carries Underwriters Laboratory Flammability Classification 94V-0
- ◆ High temperature soldering guaranteed 250°C, .25", 6.35mm from case for 10 seconds

DO-201AD

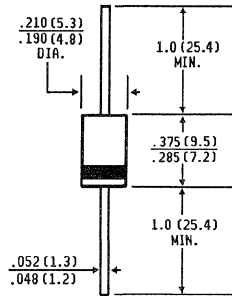

Dimensions in inches
and
(millimeters)

MECHANICAL DATA

Case: JEDEC DO-201AD, molded plastic

Terminals: Axial Leads solderable per MIL-STD-202, Method 208

Polarity: Color Band denotes Cathode

Mounting Position: Any

Weight: 0.04 ounce, 1.1 gram

MAXIMUM RATINGS AND ELECTRICAL CHARACTERISTICS

Ratings at 25°C ambient temperature unless otherwise specified.
Resistive or inductive load.
For capacitive load, derate current by 20%.

	SYMBOLS	UF 5400	UF 5401	UF 5402	UF 5403	UF 5404	UF 5405	UF 5406	UF 5407	UF 5408	UNITS
Maximum Recurrent Peak Reverse Voltage	V _{RRM}	50	100	200	300	400	500	600	800	1000	Volts
Maximum RMS Voltage	V _{RMS}	35	70	140	210	280	350	420	560	710	Volts
Maximum DC Blocking Voltage	V _{DC}	50	100	200	300	400	500	600	800	1000	Volts
Maximum Average Forward Rectified Current, .375", (9.5 mm) Lead Length at T _A = 55°C	I _(AV)	3.0									Amps
Peak Forward Surge Current 8.3ms single half sine-wave superimposed on rated load (JEDEC Method) T _A = 55°C	I _{FSM}	150.0									Amps
Maximum Instantaneous Forward Voltage at 3.0A	V _F	1.0				1.4				Volts	
Maximum DC Reverse Current T _A = 25°C at Rated DC Blocking Voltage T _A = 100°C	I _R	10.0 50.0									μA
Maximum Reverse Recovery Time (Note 1) T _J = 25°C	T _{RR}	50.0				75.0				Ns	
Typical Junction Capacitance (Note 2)	C _J	75				50.0				pf	
Maximum Thermal Resistance (Note 3)	R _{θJL}	20.0									°C/W
Operating and Storage Temperature Range	T _J , T _{STG}	-65 to +150									°C

NOTES:

1. Reverse Recovery Test Conditions : I_F = 0.5A, I_R = 1.0A, recover to 0.25A.
2. Measure at 1MHz and applied reverse voltage of 4.0 volts.
3. Thermal Resistance Junction to Lead.

RATINGS AND CHARACTERISTIC CURVES UF5400 THRU UF5408

FIG. 1 — REVERSE RECOVERY TIME CHARACTERISTIC AND TEST CIRCUIT DIAGRAM

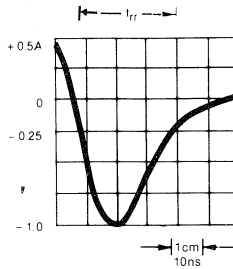
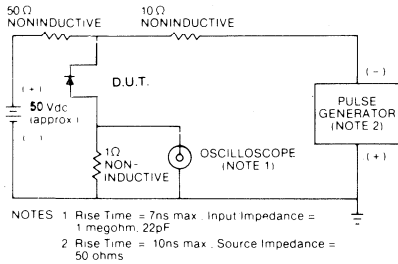

FIG. 2 — MAXIMUM AVERAGE FORWARD CURRENT RATING

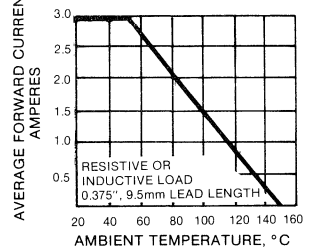

FIG. 3 — TYPICAL REVERSE CHARACTERISTICS

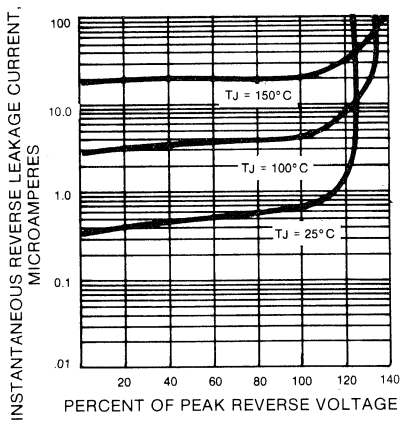
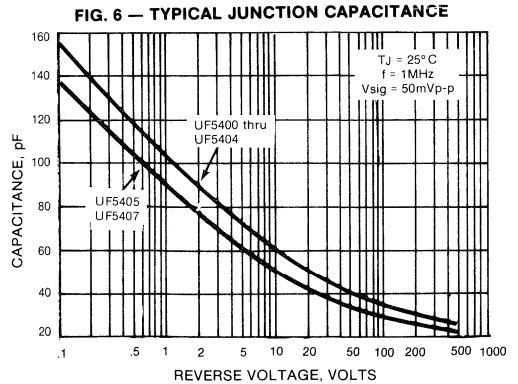
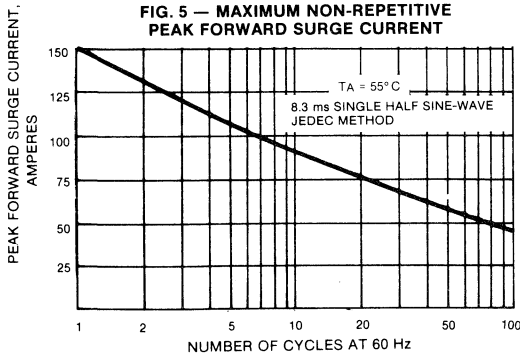
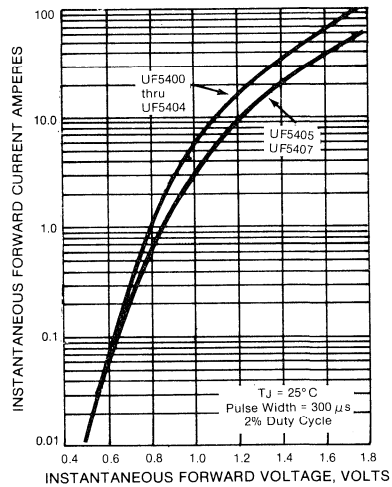

FIG. 4 — TYPICAL FORWARD CHARACTERISTICS



**MEDIUM CURRENT
FAST EFFICIENT RECTIFIERS**

6 TO 30 AMPERES

**SEE
NEW
ISOLATED
PACKAGES**



**GENERAL
INSTRUMENT**

FEPF6AT THRU FEPF6DT

FAST EFFICIENT GLASS PASSIVATED RECTIFIER

Voltage - 50 to 200 Volts Current - 6.0 Amperes

FEATURES

- ◆ Dual rectifier construction, positive center-tap
- ◆ Isolated plastic material used carries Underwriters Laboratory Flammability Classification 94V-0
- ◆ Glass passivated cavity-free junction
- ◆ Superfast recovery times, high voltage
- ◆ Low power loss, high efficiency
- ◆ Low forward voltage, high current capability
- ◆ For use in low voltage, high frequency inverters, free wheeling and polarity protection applications
- ◆ High temperature soldering guaranteed: 250°C, .25", 6.35mm from case for 10 seconds
- ◆ Internal Insulation: 1.5k VRMS



ITO-220 CT

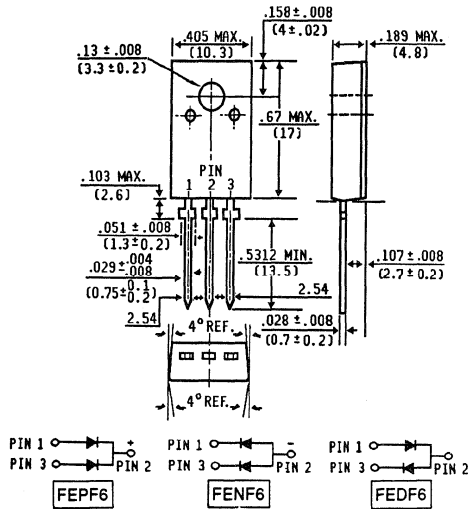

Dimensions in inches and (millimeters)

MECHANICAL DATA

Case: ITO-220 Fully overmolded plastic

Terminals: Lead solderable per MIL-STD-202, Method 208

Polarity: As marked

Mounting Position: Any

Mounting Torque: 5 in.-lb. max.

Weight: 0.08 ounce, 2.24 gram

MAXIMUM RATINGS AND ELECTRICAL CHARACTERISTICS

Ratings at 25°C ambient temperature unless otherwise specified.
Resistive or inductive load.

For capacitive load, derate current by 20%.

	SYMBOLS	FEPF6AT	FEPF6BT	FEPF6CT	FEPF6DT	UNITS
Maximum Recurrent Peak Reverse Voltage	V _{RRM}	50	100	150	200	Volts
Maximum RMS Voltage	V _{RMS}	35	70	105	140	Volts
Maximum DC Blocking Voltage	V _{DC}	50	100	150	200	Volts
Maximum Average Forward Rectified Current See Fig.1	I _(AV)	6.0				Amps
Peak Forward Surge Current 8.3ms single half sine-wave superimposed on rated load (JEDEC Method)	I _{FSM}	100.0				Amps
Maximum Instantaneous Forward Voltage at 6.0A	V _F	0.950				Volts
Maximum DC Reverse Current at Rated DC Blocking Voltage	I _R	5.0 50.0				μA
Maximum Reverse Recovery Time (Note 1)	T _{RR}	35.0				Ns
Typical Thermal Resistance (Note 2)	R _{θJC}	5.0				°C/W
Operating and Storage Temperature Range	T _J , T _{STG}	-65 to +150				°C

NOTES: 1. Reverse Recovery Test Conditions : I_F = 0.5A, I_R = 1.0A, recover to 0.25A.

2. Thermal Resistance from Junction to Case per element.

RATINGS AND CHARACTERISTIC CURVES FEFP6AT THRU FEFP6DT

FIG. 1 — FORWARD CURRENT DERATING CURVE

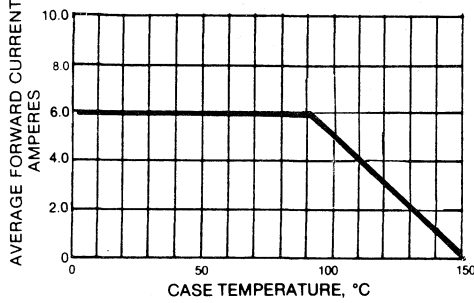

FIG. 2 — MAXIMUM NON-REPETITIVE PEAK FORWARD SURGE CURRENT

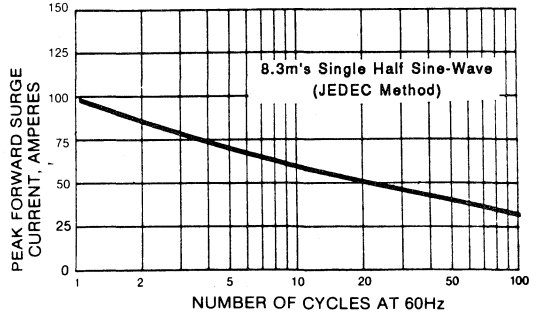

FIG. 3 — TYPICAL REVERSE CHARACTERISTICS

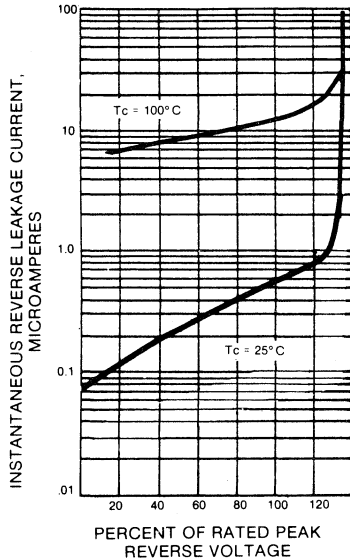

FIG. 4 — TYPICAL INSTANTANEOUS FORWARD CHARACTERISTICS

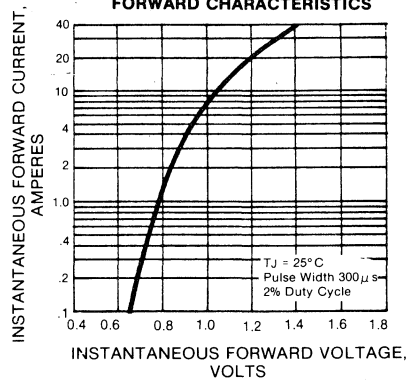
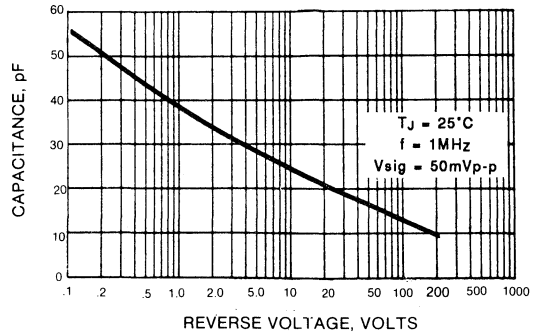

FIG. 5 — TYPICAL JUNCTION CAPACITANCE



FEP6-T SERIES

FAST EFFICIENT GLASS PASSIVATED RECTIFIER

Voltage - 50 to 200 Volts Current - 16 Amperes

FEATURES

- ◆ Dual rectifier construction, positive center-tap
- ◆ Plastic material used carries Underwriters Laboratory Flammability Classification 94V-O
- ◆ Glass passivated cavity-free junction
- ◆ Superfast recovery times, high voltage
- ◆ Low power loss, high efficiency
- ◆ Low forward voltage, high current capability
- ◆ For use in low voltage, high frequency inverters, free wheeling and polarity protection applications
- ◆ High temperature soldering guaranteed: 250°C, .25", 6.35mm from case for 10 seconds

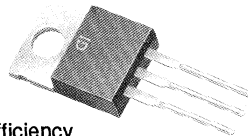

TO-220 CT

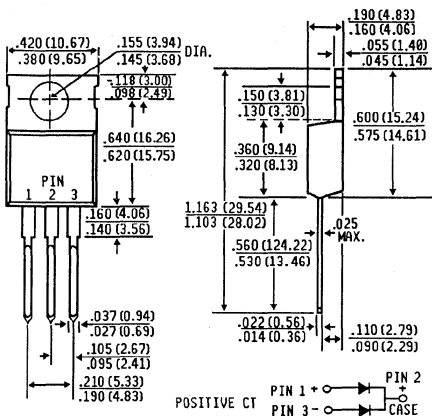

Dimensions in inches and (millimeters)

MECHANICAL DATA

Case: TO-220 CT Fully overmolded plastic

Terminals: Lead solderable per MIL-STD-202, Method 208

Polarity: As marked

Mounting Position: Any

Weight: 0.08 ounce, 2.24 gram

MAXIMUM RATINGS AND ELECTRICAL CHARACTERISTICS

Ratings at 25°C ambient temperature unless otherwise specified.

Resistive or inductive load.

For capacitive load, derate current by 20%.

	SYMBOLS	FEP6AT	FEP6BT	FEP6CT	FEP6DT	UNITS
Maximum Recurrent Peak Reverse Voltage	V _{RRM}	50	100	150	200	Volts
Maximum RMS Voltage	V _{RMS}	35	70	105	140	Volts
Maximum DC Blocking Voltage	V _{DC}	50	100	150	200	Volts
Maximum Average Forward Rectified Current .375", (9.5mm) Lead Lengths at 100°C	I _(AV)	6.0				Amps
Peak Forward Surge Current 8.3ms single half sine-wave superimposed on rated load (JEDEC Method)	I _{FSM}	100.0				Amps
Maximum Instantaneous Forward Voltage at 3.0A	V _F	0.975				Volts
Maximum DC Reverse Current at Rated DC Blocking Voltage T _A = 25°C T _A = 100°C	I _R	5.0 50.0				μA μA
Maximum Reverse Recovery Time (Note 1) T _J = 25°C	T _{RR}	35.0				Ns
Typical Thermal Resistance (Note 3)	R _{θJC}	5.5				°C/W
Operating and Storage Temperature Range	T _J , T _{STG}	-65 to +150				°C

NOTES:

1. Reverse Recovery Test Conditions : I_F = 5.0A, I_R = 1.0A, I_{RR} = 25A.
2. Measured at 1 MHz and applied reverse voltage of 4.0 volts.
3. Thermal Resistance from Junction to Case.

RATINGS AND CHARACTERISTIC CURVES FEP6AT THRU FEP6DT

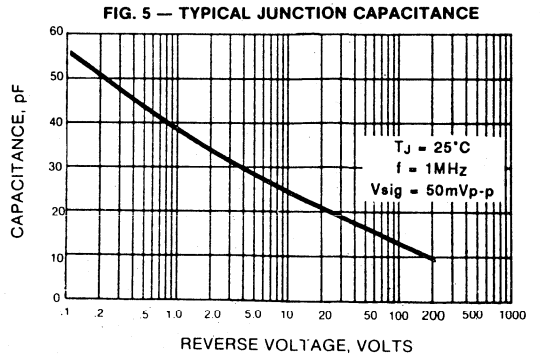
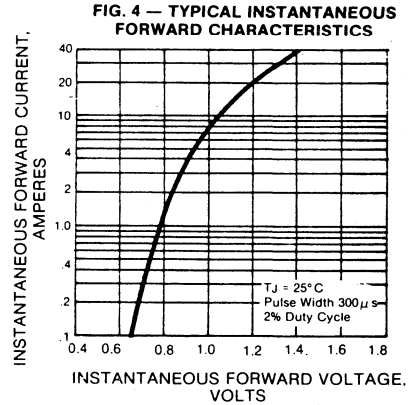
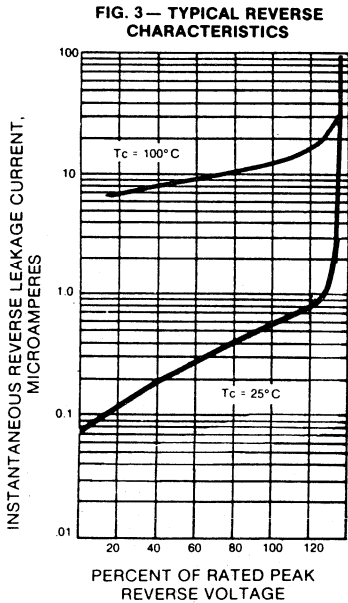
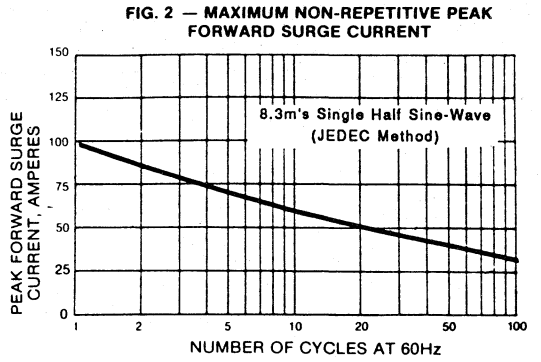
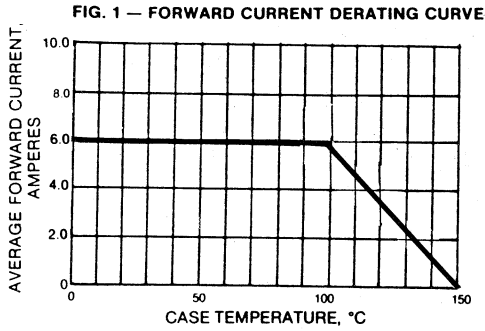

**GENERAL
INSTRUMENT**

FESF8AT THRU FESF8JT

FAST EFFICIENT GLASS PASSIVATED RECTIFIER
Voltage - 50 to 600 Volts Current - 8.0 Amperes

FEATURES

- ◆ Isolated plastic material used carries Underwriters Laboratory Flammability Classification 94V-O
- ◆ Glass passivated cavity-free junction
- ◆ Low power loss, high efficiency
- ◆ Low leakage
- ◆ High surge capability
- ◆ Superfast recovery times, high voltage
- ◆ High temperature soldering guaranteed: 250°C, .25", 6.35mm from case for 10 seconds
- ◆ Internal Insulation: 1.5K VRMS

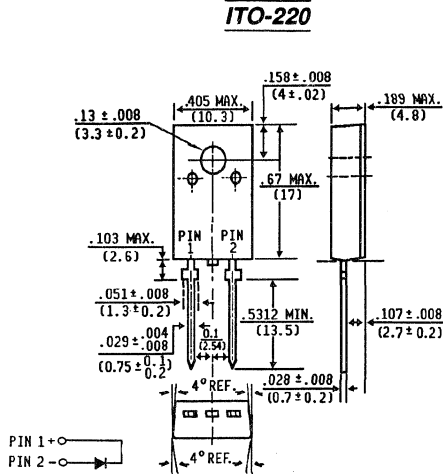
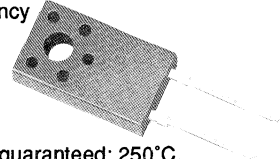

Dimensions in inches and (millimeters)

MECHANICAL DATA

Case: ITO-220 fully overmolded plastic

Terminals: Lead solderable per MIL-STD-202, Method 208

Polarity: As marked

Mounting Position: Any

Mounting Torque: 5 in.- lbs. max.

Weight: 0.08 ounce, 2.24

MAXIMUM RATINGS AND ELECTRICAL CHARACTERISTICS

Ratings at 25°C ambient temperature unless otherwise specified.
 Resistive or inductive load.
 For capacitive load, derate current by 20%.

		FESF 8AT	FESF 8BT	FESF 8CT	FESF 8DT	FESF 8FT	FESF 8GT	FESF 8HT	FESF 8JT	UNITS
Maximum Recurrent Peak Reverse Voltage	V _{RRM}	50	100	150	200	300	400	500	600	Volts
Maximum RMS Voltage	V _{RMS}	35	70	105	140	210	280	350	420	Volts
Maximum DC Blocking Voltage	V _{DC}	50	100	150	200	300	400	500	600	Volts
Maximum Average Forward Rectified Current See Fig.1	I _(AV)	8.0								Amps
Peak Forward Surge Current 8.3ms single half sine-wave superimposed on rated load (JEDEC Method)	I _{FSM}	125								Amps
Maximum Instantaneous Forward Voltage at 8.0A	V _F	0.95		1.3		1.5				Volts
Maximum DC Reverse Current T _C = 25°C at Rated DC Blocking Voltage T _C = 100°C	I _R	10.0 500								μA
Maximum Reverse Recovery Time (Note 2) T _J = 25°C	T _{RR}	35			50					Ns
Typical Junction Capacitance (Note 1)	C _J	65								pf
Typical Thermal Resistance (Note 3)	R _{θJC}	2.2								°C/W
Operating and Storage Temperature Range	T _J , T _{STG}	-65 to +150								°C

NOTES:

1. Measured at 1 MHz and applied reverse voltage of 4.0 volts.
2. Reverse Recovery Test Conditions : I_F = 0.5A, I_R = 1.0A, recover to 0.25A.
3. Thermal Resistance Junction to Case.

RATINGS AND CHARACTERISTIC CURVES FESF8AT THRU FESF8JT SERIES

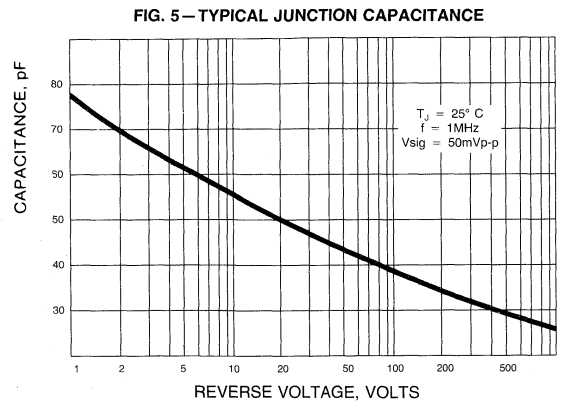
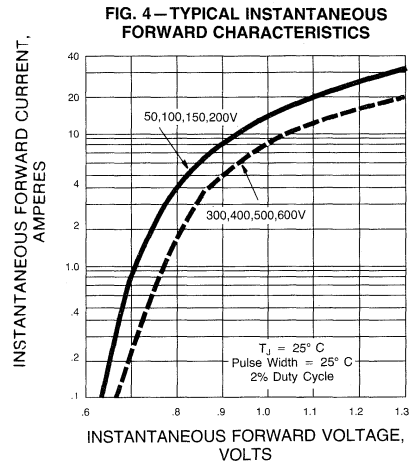
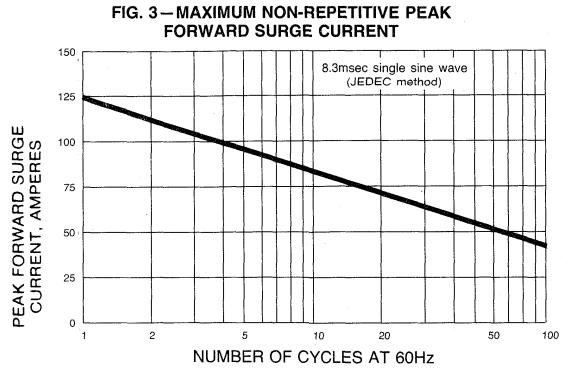
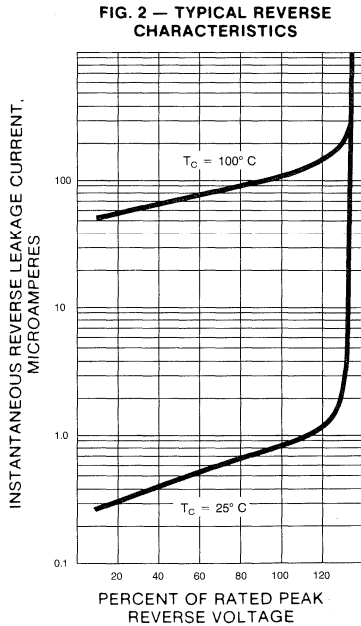
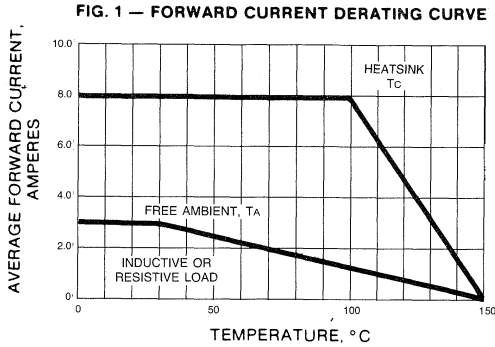

FES8AT THRU FES8JT

FAST EFFICIENT GLASS PASSIVATED RECTIFIER

Voltage - 50 to 600 Volts Current - 8.0 Amperes

FEATURES

- ◆ Plastic material used carries Underwriters Laboratory Flammability Classification 94V-0
- ◆ Glass passivated cavity-free junction
- ◆ Low power, high efficiency
- ◆ Low Leakage
- ◆ High surge capability
- ◆ Superfast recovery times, high voltage
- ◆ High temperature soldering guaranteed 250°C, .25", 6.35mm from case for 10 seconds

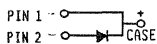
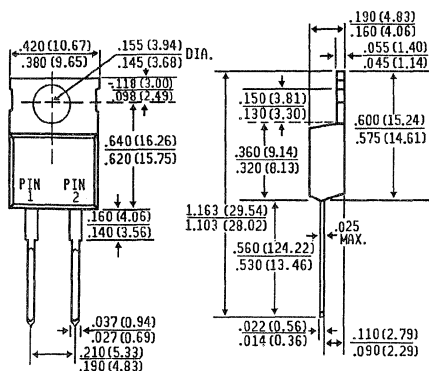

(CASE POSITIVE)
STANDARD POLARITY
FES8

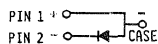

(CASE NEGATIVE)
SUFFIX "R"
FER8

Dimensions in inches and (millimeters)

MECHANICAL DATA

Case: TO-220 molded plastic

Terminals: Lead solderable per MIL-STD-202, Method 208

Polarity: As marked

Mounting Position: Any

Weight: 0.08 ounce, 2.24 gram

MAXIMUM RATINGS AND ELECTRICAL CHARACTERISTICS

Ratings at 25°C ambient temperature unless otherwise specified.

Resistive or inductive load.

For capacitive load, derate current by 20%.

	FES SYMBOLS	8AT	FES 8BT	FES 8CT	FES 8DT	FES 8FT	FES 8GT	FES 8HT	FES 8JT	UNITS
Maximum Recurrent Peak Reverse Voltage	V _{RRM}	50	100	150	200	300	400	500	600	Volts
Maximum RMS Voltage	V _{RMS}	35	70	105	140	210	280	350	420	Volts
Maximum DC Blocking Voltage	V _{DC}	50	100	150	200	300	400	500	600	Volts
Maximum Average Forward Rectified Current at T _C = 100°C	I _(AV)	8.0								Amps
Peak Forward Surge Current 8.3ms single half sine-wave superimposed on rated load (JEDEC Method)	I _{FSM}	125								Amps
Maximum Instantaneous Forward Voltage at 8.0A	V _F	0.95		1.3		1.5		Volts		
Maximum DC Reverse Current T _C = 25°C at Rated DC Blocking Voltage T _C = 100°C	I _R	10.0 500								μA
Maximum Reverse Recovery Time (Note 2) T _J = 25°C	T _{RR}	35			50			Ns		
Typical Junction Capacitance (Note 1)	C _J	65								pf
Typical Thermal Resistance (Note 3)	R _{θJC}	3.0								°C/W
Operating and Storage Temperature Range	T _J , T _{STG}	-65 to +150								°C

NOTES:

1. Measured at 1 MHz and applied reverse voltage of 4.0 volts.
2. Reverse Recovery Test Conditions : I_F = 0.5A, I_R = 1.0A, recover to 0.25A.
3. Thermal Resistance Junction to CASE.

RATINGS AND CHARACTERISTIC CURVES FES8AT THRU FES8JT SERIES

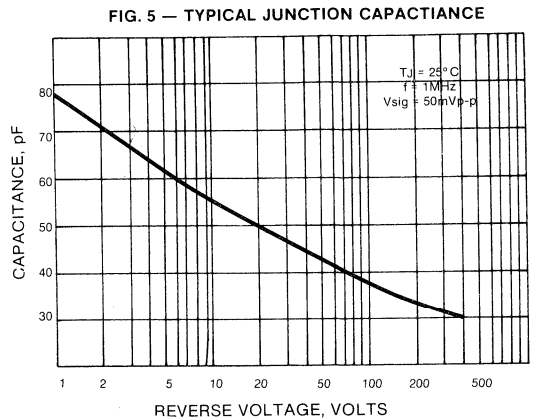
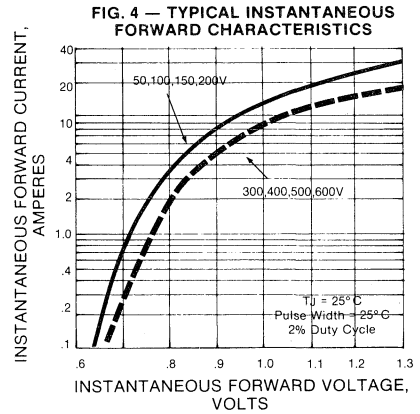
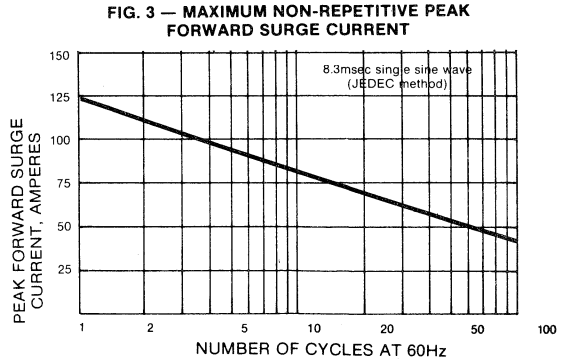
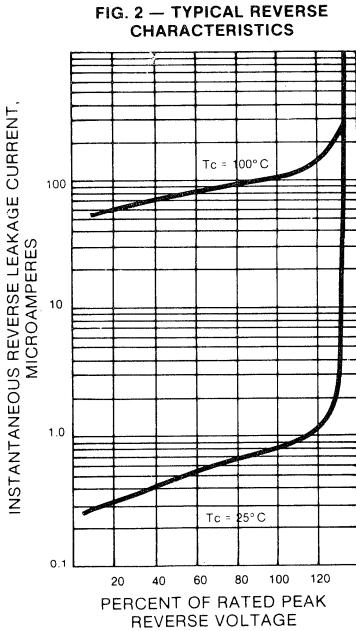
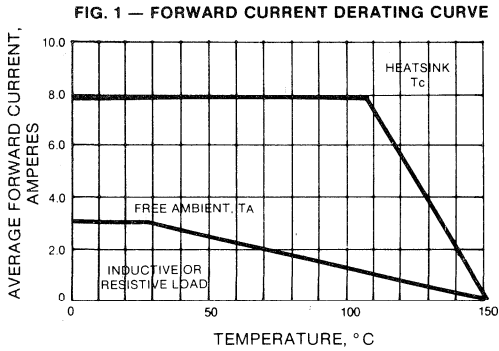

GI1401 THRU GI1404

8.0 AMPERE GLASS PASSIVATED FAST EFFICIENT RECTIFIER

Voltage - 50 to 200 Volts Current - 8.0 Amperes

FEATURES

- ◆ Plastic material used carries Underwriters Laboratory Flammability Classification 94V-O
- ◆ Glass passivated cavity-free junction
- ◆ Low power, high efficiency
- ◆ Low Leakage
- ◆ High surge capability
- ◆ Superfast recovery times, high voltage
- ◆ High temperature soldering guaranteed: 250°C, .25", 6.35mm from case for 10 seconds

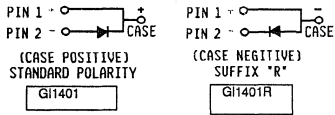
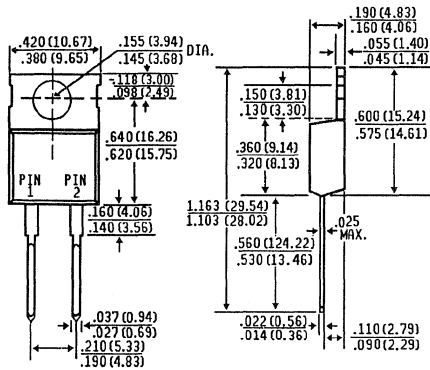
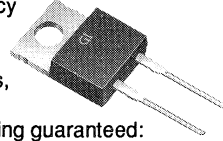

Dimensions in inches and (millimeters)

MECHANICAL DATA

- Case:** TO-220 molded plastic
Terminals: Lead solderable per MIL-STD-202, Method 208
Polarity: As marked
Mounting Position: Any
Weight: 0.08 ounce, 2.24 gram

MAXIMUM RATINGS AND ELECTRICAL CHARACTERISTICS

Ratings at 25°C ambient temperature unless otherwise specified.
 Resistive or inductive load.
 For capacitive load, derate current by 20%.

	SYMBOLS	GI1401	GI1402	GI1403	GI1404	UNITS
Maximum Recurrent Peak Reverse Voltage	V _{RRM}	50	100	150	200	Volts
Maximum RMS Voltage	V _{RMS}	35	70	105	140	Volts
Maximum DC Blocking Voltage	V _{DC}	50	100	150	200	Volts
Maximum Average Forward Rectified Current at T _C = 125°C	I _(AV)	8.0				Amps
Peak Forward Surge Current 8.3ms single half sine-wave superimposed on rated load (JEDEC Method)	I _{FSM}	125				Amps
Maximum Instantaneous Forward Voltage I _F = 4A, T _J = 100°C I _F = 8A, T _J = 100°C I _F = 4A, T _J = 25°C I _F = 8A, T _J = 25°C	V _F	.800 .895 .900 .975				Volts
Maximum DC Reverse Current T _C = 25°C at Rated DC Blocking Voltage T _C = 100°C	I _R	5.0 150				µA
Maximum Reverse Recovery Time (Note 1) T _J = 25°C	T _{RR}	35				Ns
Typical Junction Capacitance (Note 2)	C _J	42				pf
Typical Thermal Resistance (Note 3)	R _{θJC}	2.50				°C/W
Operating and Storage Temperature Range	T _J , T _{STG}	-65 to +150				°C

- NOTES:**
 1. Reverse Recovery Test Conditions : I_F = 0.5A, I_R = 1.0A, recover to 0.25A.
 2. Measured at 1 MHz and applied reverse voltage of 4.0 volts.
 3. Thermal Resistance Junction to CASE.

RATINGS AND CHARACTERISTIC CURVES GI1401 THRU GI1404

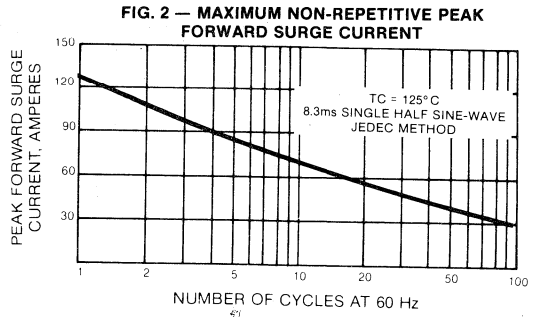
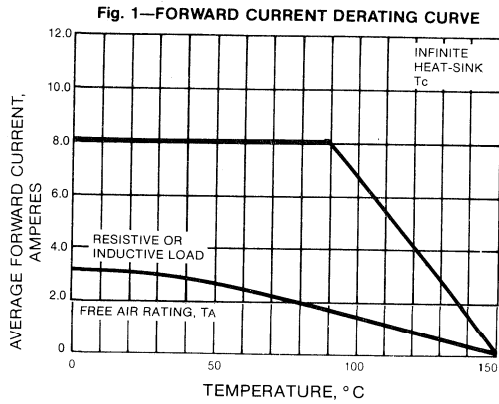

Fig. 3 — TYPICAL REVERSE CHARACTERISTICS

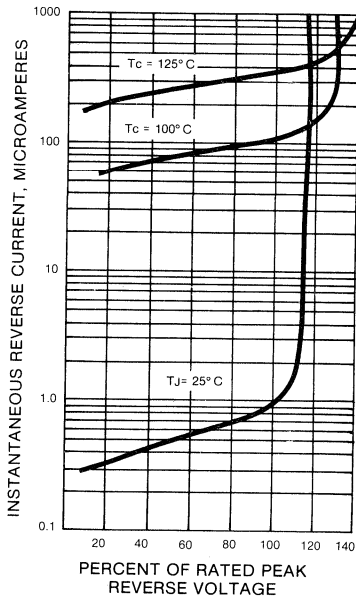

Fig. 4—TYPICAL INSTANTANEOUS FORWARD CHARACTERISTICS

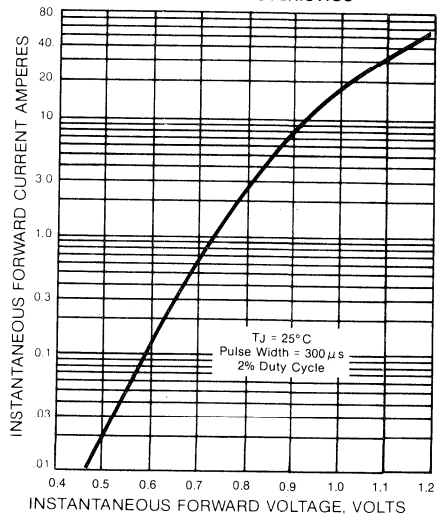
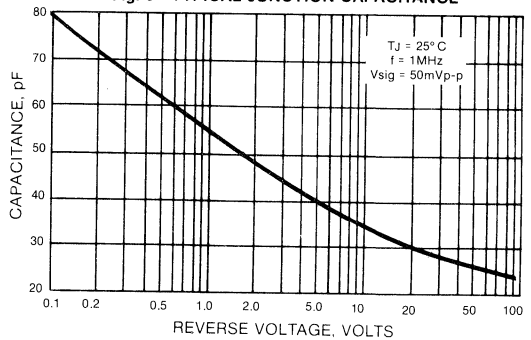

Fig. 5—TYPICAL JUNCTION CAPACITANCE



BYW29-50 THRU BYW29-200

8.0 AMPERE GLASS FAST EFFICIENT PASSIVATED RECTIFIER

Voltage - 50 to 200 Volts Current - 8.0 Amperes

FEATURES

- ◆ Plastic material used carries Underwriters Laboratory Flammability Classification 94V-0
- ◆ Glass passivated cavity-free junction
- ◆ Low power, high efficiency
- ◆ Low Leakage
- ◆ High surge capability
- ◆ Superfast recovery times, high voltage
- ◆ High temperature soldering guaranteed 300°C, 6.35mm from case for 10 seconds

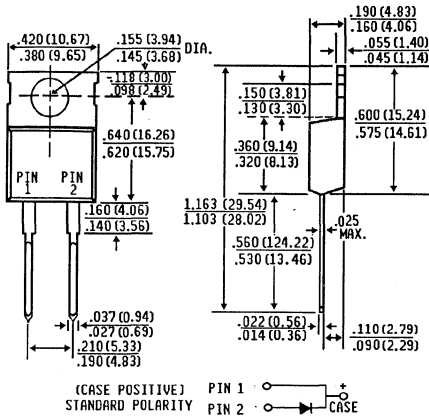
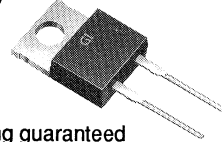

Dimensions in inches and (millimeters)

MECHANICAL DATA

Case: TO-220 molded plastic

Terminals: Lead solderable per MIL-STD-202, Method 208

Polarity: As marked

Mounting Position: Any

Weight: 0.08 ounce, 2.24 gram

MAXIMUM RATINGS AND ELECTRICAL CHARACTERISTICS

Ratings at 25°C ambient temperature unless otherwise specified.
Resistive or inductive load.
For capacitive load, derate current by 20%.

	SYMBOLS	BYW29-50	BYW29-100	BYW29-150	BYW29-200	UNITS
Maximum Recurrent Peak Reverse Voltage	V _R RRM	50	100	150	200	Volts
Maximum RMS Voltage	V _R RMS	35	70	105	140	Volts
Maximum DC Blocking Voltage	V _D DC	50	100	150	200	Volts
Maximum Average Forward Rectified Current at T _C = 125°C	I _F (AV)	8.0				Amps
Peak Forward Surge Current 10ms single half sine-wave superimposed T _J = 150°C	I _F FSM	100				Amps
Maximum Instantaneous Forward Voltage I _F = 20A, T _J = 25°C I _F = 8A, T _J = 150°C	V _F	1.3 0.8				Volts
Maximum DC Reverse Current T _C = 25°C at Rated DC Blocking Voltage T _C = 100°C	I _R	10.0 500				µA
Maximum Reverse Recovery Time (Note 2)	T _{RR}	25				Ns
Typical Junction Capacitance (Note 1)	C _J	45				pf
Maximum Thermal Resistance (Note 3)	R _θ JC	3.0				°C/W
Operating and Storage Temperature Range	T _J , T _{STG}	-65 to +150				°C

NOTES:

1. Measured at 1 MHz and applied reverse voltage of 4.0 volts.
2. Reverse Recovery Test Conditions : I_F = 1A to 30V, with -di/dt = 100A/µs.
3. Thermal Resistance Junction to CASE.

RATINGS AND CHARACTERISTIC CURVES BYW29-50 THRU BYW29-200

FIG. 1 — FORWARD CURRENT DERATING CURVE

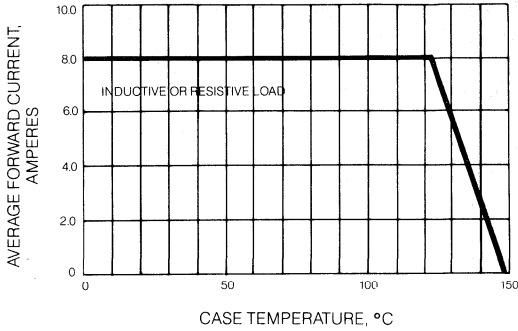

FIG. 2 — MAXIMUM NON-REPETITIVE PEAK FORWARD SURGE CURRENT

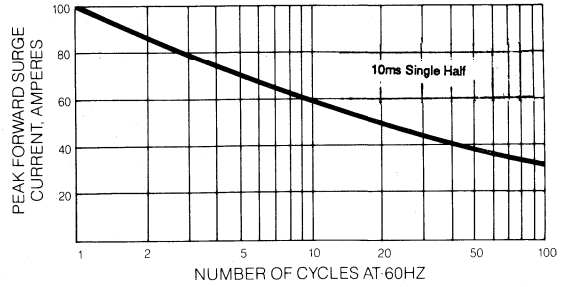

FIG. 4 — TYPICAL INSTANTANEOUS FORWARD CHARACTERISTICS

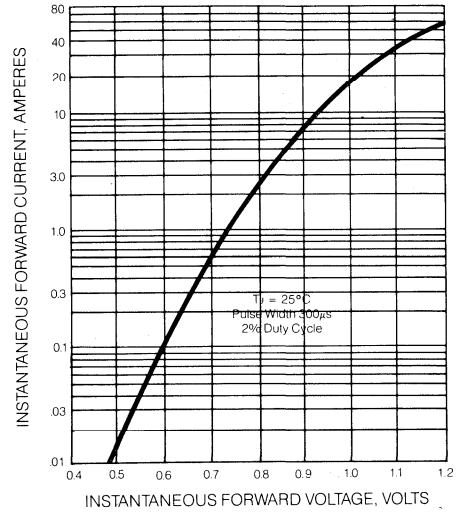

FIG. 3 — TYPICAL REVERSE CHARACTERISTICS

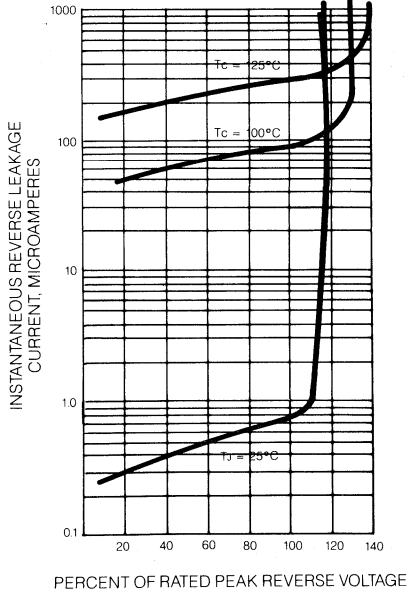
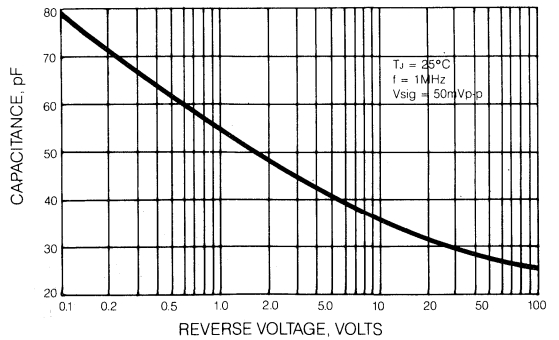

FIG. 5 — TYPICAL JUNCTION CAPACITANCE



FESF16AT THRU FESF16JT

FAST EFFICIENT GLASS PASSIVATED RECTIFIER

Voltage - 50 to 600 Volts Current - 16 Amperes

FEATURES

- ◆ Isolated plastic material used carries Underwriters Laboratory Flammability Classification 94V-O
- ◆ Glass passivated cavity-free junction
- ◆ Low power loss, high efficiency
- ◆ Low forward voltage, high current capability
- ◆ High surge capability
- ◆ Superfast recovery times, high voltage
- ◆ High temperature soldering guaranteed: 250°C, .25", 6.35mm from case for 10 seconds
- ◆ Internal Insulation: 1.5k VRMS

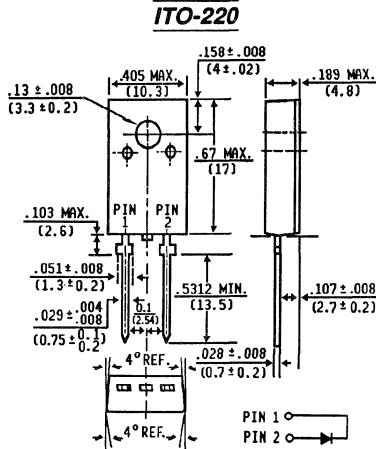
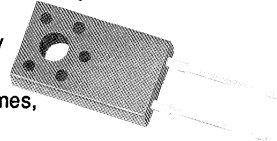

Dimensions in inches and (millimeters)

MECHANICAL DATA

Case: ITO-220 Fully overmolded plastic

Terminals: Lead solderable per MIL-STD-202 Method 208

Polarity: As marked

Mounting Position: Any

Mounting Torque: 5 in. - lb. max.

Weight: 0.08 ounce, 2.24 gram

MAXIMUM RATINGS AND ELECTRICAL CHARACTERISTICS

Ratings at 25°C ambient temperature unless otherwise specified.
Resistive or inductive load.
For capacitive load, derate current by 20%.

	SYMBOLS	FESF	FESF	FESF	FESF	FESF	FESF	FESF	UNITS	
		16AT	16BT	16CT	16DT	16FT	16GT	16HT		16JT
Maximum Recurrent Peak Reverse Voltage	V _{RRM}	50	100	150	200	300	400	500	600	Volts
Maximum RMS Voltage	V _{RMS}	35	70	105	140	210	280	350	420	Volts
Maximum DC Blocking Voltage	V _{DC}	50	100	150	200	300	400	500	600	Volts
Maximum Average Forward Rectified Current See Fig.1	I <sub(av)< sub=""></sub(av)<>	16.0								Amps
Peak Forward Surge Current 8.3ms single half sine-wave superimposed on rated load (JEDEC Method)	I _{FSM}	250								Amps
Maximum Instantaneous Forward Voltage at 16A	V _F		.95			1.3	1.5		Volts	
Maximum DC Reverse Current at Rated DC Blocking Voltage T _C = 25°C T _C = 100°C	I _R	10.0 500								μA
Maximum Reverse Recovery Time (Note 2) T _J = 25°C	T _{RR}		35			50			Ns	
Typical Junction Capacitance (Note 1)	C _J	65								pf
Thermal Resistance (Note 3)	R _{θJC}	1.7								°C/W
Operating and Storage Temperature Range	T _J , T _{STG}	-65 to +150								°C

NOTES: 1. Measured at 1 MHz and applied reverse voltage of 4.0 volts.
2. Reverse Recovery Test Conditions : I_F = 0.5A, I_R = 1.0A, recover to 0.25A.
3. Thermal Resistance Junction to Case.

RATINGS AND CHARACTERISTIC CURVES FESF16AT THRU FESF16JT

Fig. 1 — FORWARD CURRENT DERATING CURVE

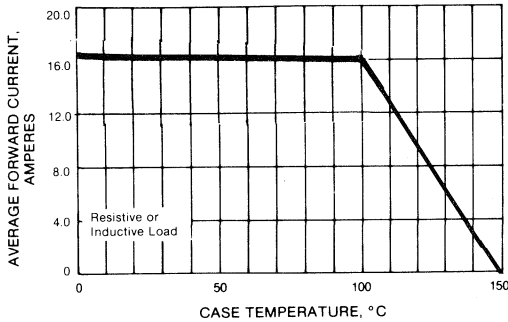

FIG. 2—TYPICAL REVERSE CHARACTERISTICS

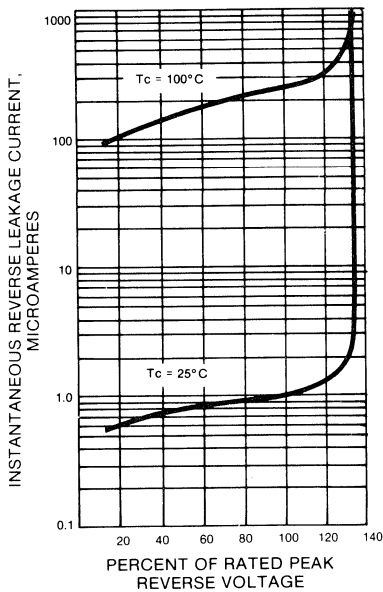

FIG. 3 — MAXIMUM NON REPETITIVE PEAK FORWARD SURGE CURRENT

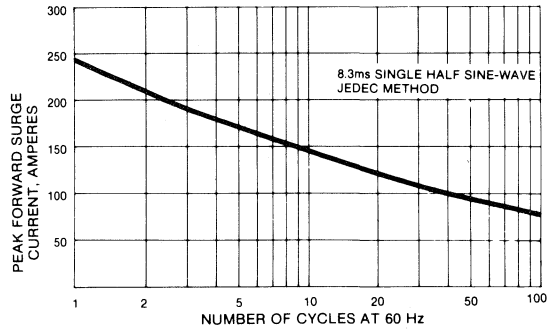

FIG. 4—TYPICAL INSTANTANEOUS FORWARD CHARACTERISTICS

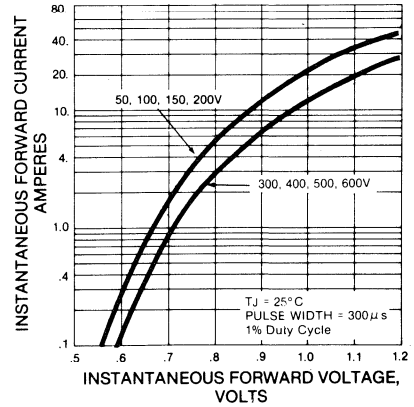
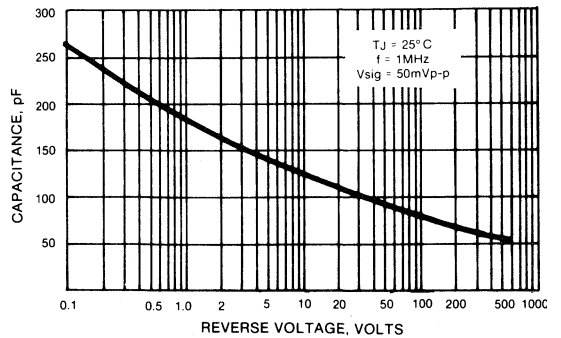

FIG. 5 — TYPICAL JUNCTION CAPACITANCE



FES16AT THRU FES16JT

FAST EFFICIENT GLASS PASSIVATED RECTIFIER

Voltage - 50 to 600 Volts Current - 16 Amperes

FEATURES

- ◆ Plastic material used carries Underwriters Laboratory Flammability Classification 94V-0
- ◆ Glass passivated cavity-free junction
- ◆ Low power, high efficiency
- ◆ Low forward voltage, high current capability
- ◆ High surge capability
- ◆ Superfast recovery times, high voltage
- ◆ High temperature soldering guaranteed: 250°C, .25" (6.35mm) from case for 10 seconds

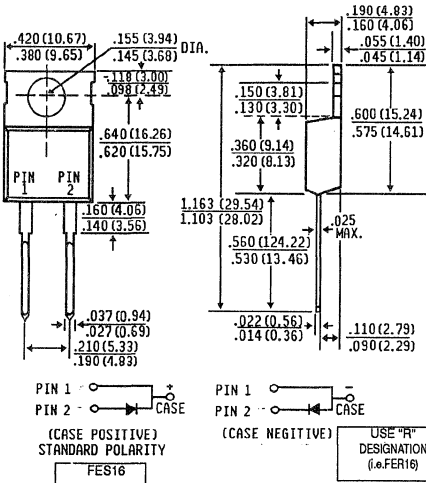
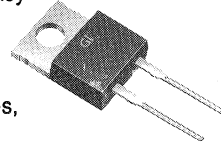

Dimensions in inches and (millimeters)

MECHANICAL DATA

Case: TO-220 molded plastic

Terminals: Lead solderable per MIL-STD-202, Method 208

Polarity: As marked

Mounting Position: Any

Weight: 0.08 ounce, 2.24 gram

MAXIMUM RATINGS AND ELECTRICAL CHARACTERISTICS

Ratings at 25°C ambient temperature unless otherwise specified.

Resistive or inductive load.

For capacitive load, derate current by 20%.

		FES SYMBOLS	FES 16AT	FES 16BT	FES 16CT	FES 16DT	FES 16FT	FES 16GT	FES 16HT	FES 16JT	UNITS
Maximum Recurrent Peak Reverse Voltage	V_{RRM}	50	100	150	200	300	400	500	600		Volts
Maximum RMS Voltage	V_{RMS}	35	70	105	140	210	280	350	420		Volts
Maximum DC Blocking Voltage	V_{DC}	50	100	150	200	300	400	500	600		Volts
Maximum Average Forward Rectified Current at $T_C = 100^\circ\text{C}$	$I_{(AV)}$					16.0					Amps
Peak Forward Surge Current 8.3ms single half sine-wave superimposed on rated load (JEDEC Method)	I_{FSM}					250					Amps
Maximum Instantaneous Forward Voltage at 16A	V_F			.975			1.3	1.5			Volts
Maximum DC Reverse Current $T_C = 25^\circ\text{C}$ at Rated DC Blocking Voltage $T_C = 100^\circ\text{C}$	I_R					10.0					μA
Maximum Reverse Recovery Time (Note 2) $T_J = 25^\circ\text{C}$	T_{RR}			35			50				Ns
Typical Junction Capacitance (Note 1)	C_J					65					pf
Thermal Resistance (Note 3)	$R_{\theta JC}$					1.50					$^\circ\text{C/W}$
Operating and Storage Temperature Range	T_J, T_{STG}					-65 to +150					$^\circ\text{C}$

NOTES:

1. Measured at 1 MHz and applied reverse voltage of 4.0 volts.
2. Reverse Recovery Test Conditions : $I_F = 0.5\text{A}$, $I_R = 1.0\text{A}$, recover to 0.25A.
3. Thermal Resistance Junction to CASE.

RATINGS AND CHARACTERISTIC CURVES FES16AT THRU FES16JT SERIES

Fig. 1— FORWARD CURRENT DERATING CURVE

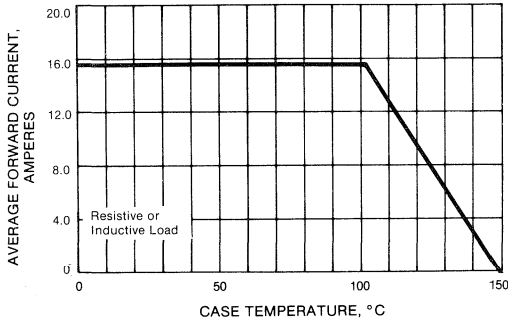

FIG. 2—TYPICAL REVERSE CHARACTERISTICS

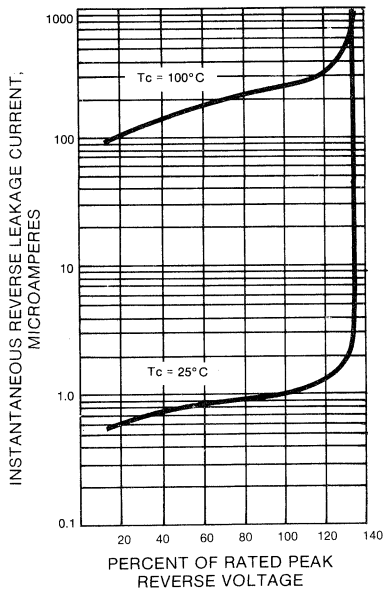

FIG. 3 — MAXIMUM NON REPETITIVE PEAK FORWARD SURGE CURRENT

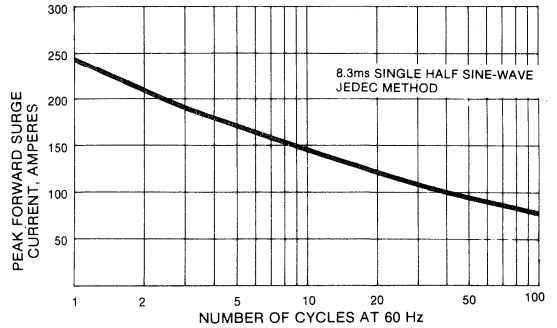

Fig. 4— TYPICAL INSTANTANEOUS FORWARD CHARACTERISTICS

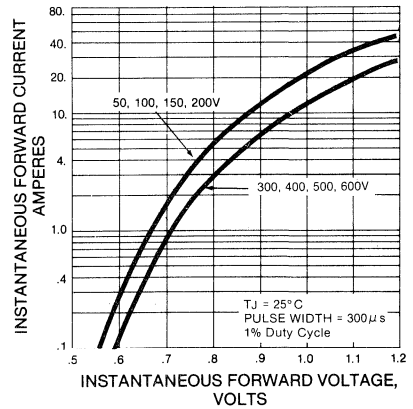
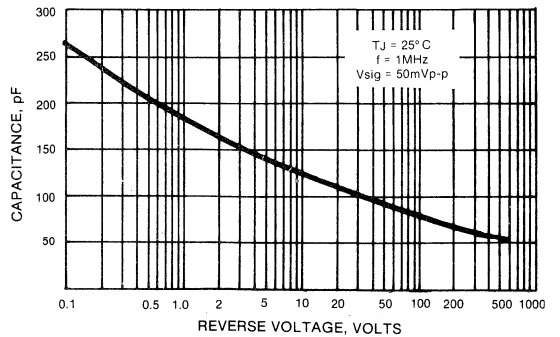

FIG. 5 — TYPICAL JUNCTION CAPACITANCE



FEPF16AT THRU FEPF16JT

FAST EFFICIENT GLASS PASSIVATED RECTIFIER

Voltage - 50 to 600 Volts Current - 16 Amperes

FEATURES

- ◆ Dual rectifier construction, positive center tap
- ◆ Isolated plastic material used carries Underwriters Laboratory Flammability Classification 94V-0
- ◆ Glass passivated cavity-free junction
- ◆ Low power loss, high efficiency
- ◆ Low forward voltage, high current capability
- ◆ High surge capability
- ◆ Superfast recovery times, high voltage
- ◆ High temperature soldering guaranteed: 250°C, .25", 6.35mm from case for 10 seconds
- ◆ Internal Insulation: 1.5K VRMS



ITO-220 CT

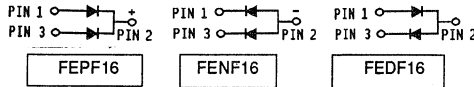
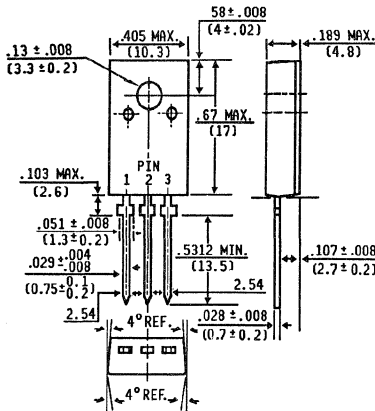

Dimensions in inches and (millimeters)

MECHANICAL DATA

Case: ITO-220 fully overmolded plastic

Terminals: Lead solderable per MIL-STD-202, Method 208

Polarity: As marked

Mounting Position: Any

Mounting Torque: 5 in. - lbs. max.

Weight: 0.08 ounce, 2.24 gram

MAXIMUM RATINGS AND ELECTRICAL CHARACTERISTICS

Ratings at 25°C ambient temperature unless otherwise specified.
Resistive or inductive load.
For capacitive load, derate current by 20%.

	SYMBOLS	FEPF	FEPF	FEPF	FEPF	FEPF	FEPF	FEPF	UNITS	
		16AT	16BT	16CT	16DT	16FT	16GT	16HT		16JT
Maximum Recurrent Peak Reverse Voltage	V _{RRM}	50	100	150	200	300	400	500	600	Volts
Maximum RMS Voltage	V _{RMS}	35	70	105	140	210	280	350	420	Volts
Maximum DC Blocking Voltage	V _{DC}	50	100	150	200	300	400	500	600	Volts
Maximum Average Forward Rectified Current See Fig.1	I _(AV)	16.0								Amps
Peak Forward Surge Current 8.3ms single half sine-wave superimposed on rated load (JEDEC Method)	I _{FSM}	200								Amps
Maximum Instantaneous Forward Voltage at 8.0A per element	V _F	.950		1.3		1.5			Volts	
Maximum DC Reverse Current at Rated DC Blocking Voltage T _C = 25°C T _C = 100°C	I _R	10.0 500								μA
Maximum Reverse Recovery Time (Note 2) T _J = 25°C	T _{RR}	35		50					Ns	
Typical Junction Capacitance (Note 1)	C _J	65								pf
Thermal Resistance (Note 3)	R _{θJC}	2.2								°C/W
Operating and Storage Temperature Range	T _J , T _{STG}	-65 to +150								°C

NOTES: 1. Measured at 1 MHz and applied reverse voltage of 4.0 volts.
2. Reverse Recovery Test Conditions : I_F = 0.5A, I_R = 1.0A, recover to 0.25A.
3. Thermal Resistance Junction to Case per element.

RATINGS AND CHARACTERISTIC CURVES FEPF16AT THRU FEPF16JT SERIES

FIG. 1 — FORWARD CURRENT DERATING CURVE

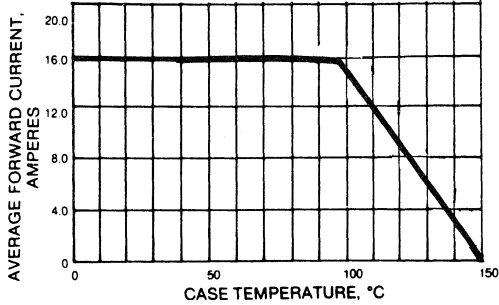

FIG. 3 — MAXIMUM NON-REPETITIVE PEAK FORWARD SURGE CURRENT

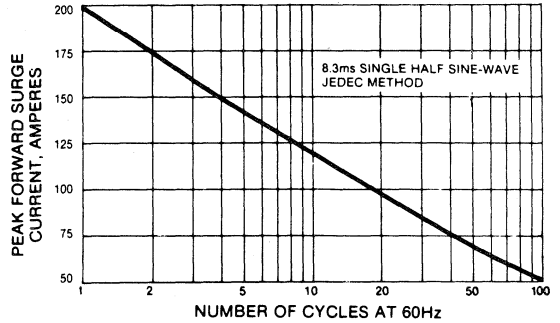

FIG. 4 — TYPICAL INSTANTANEOUS FORWARD CHARACTERISTICS

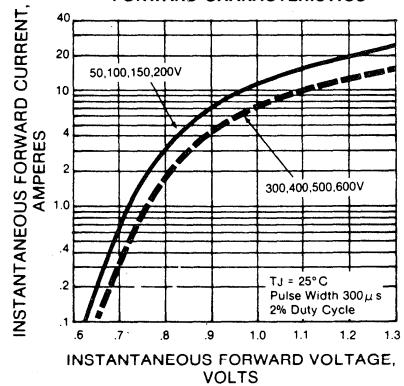

FIG. 2 — TYPICAL REVERSE CHARACTERISTICS

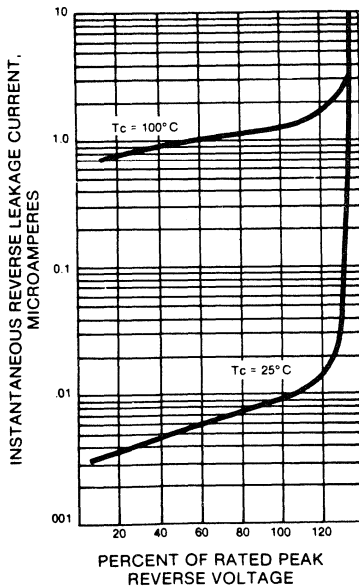
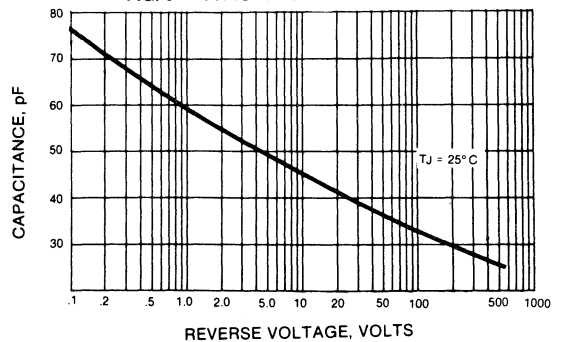

FIG. 5 — TYPICAL JUNCTION CAPACITANCE



FEP16AT THRU FEP16JT

FAST EFFICIENT GLASS PASSIVATED RECTIFIER

Voltage - 50 to 600 Volts Current - 16 Amperes

FEATURES

- ◆ Dual rectifier construction, positive centertap
- ◆ Plastic material used carries Underwriters Laboratory Flammability Classification 94V-0
- ◆ Glass passivated cavity-free junction
- ◆ Low power, high efficiency
- ◆ Low forward voltage, high current capability
- ◆ High surge capability
- ◆ Superfast recovery times, high voltage
- ◆ High temperature soldering guaranteed 250°C, .25", 6.35mm from case for 10 seconds

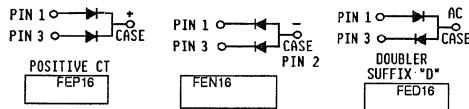
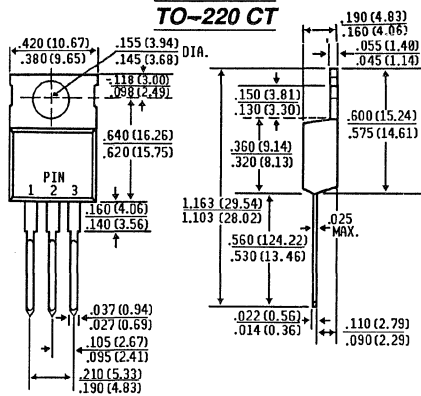
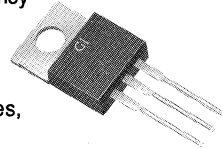

Dimensions in inches and (millimeters)

MECHANICAL DATA

Case: TO-220 molded plastic

Terminals: Lead solderable per MIL-STD-202, Method 208

Polarity: As marked

Mounting Position: Any

Weight: 0.08 ounce, 2.24 gram

MAXIMUM RATINGS AND ELECTRICAL CHARACTERISTICS

Ratings at 25°C ambient temperature unless otherwise specified.
Resistive or inductive load.
For capacitive load, derate current by 20%.

		FEP SYMBOLS	FEP 16AT	FEP 16BT	FEP 16CT	FEP 16DT	FEP 16FT	FEP 16GT	FEP 16HT	FEP 16JT	UNITS
Maximum Recurrent Peak Reverse Voltage	V _{RRM}	50	100	150	200	300	400	500	600	600	Volts
Maximum RMS Voltage	V _{RMS}	35	70	105	140	210	280	350	420	420	Volts
Maximum DC Blocking Voltage	V _{DC}	50	100	150	200	300	400	500	600	600	Volts
Maximum Average Forward Rectified Current at T _C = 100°C	I _(AV)	16.0									Amps
Peak Forward Surge Current 8.3ms single half sine-wave superimposed on rated load (JEDEC Method)	I _{FSM}	200									Amps
Maximum Instantaneous Forward Voltage at 8.0A	V _F	.975			1.3		1.5				Volts
Maximum DC Reverse Current T _C = 25°C at Rated DC Blocking Voltage T _C = 100°C	I _R	10.0 500									μA
Maximum Reverse Recovery Time (Note 2) T _J = 25°C	T _{RR}	35			50						Ns
Typical Junction Capacitance (Note 1)	C _J	65									pf
Thermal Resistance (Note 3)	R _{ΘJC}	3.0									°C/W
Operating and Storage Temperature Range	T _J , T _{STG}	-65 to +150									°C

NOTES:

1. Measured at 1 MHz and applied reverse voltage of 4.0 volts.
2. Reverse Recovery Test Conditions : I_F = 0.5A, I_R = 1.0A, recover to 0.25A.
3. Thermal Resistance Junction to CASE.

RATINGS AND CHARACTERISTIC CURVES FEP16AT THRU FEP16JT

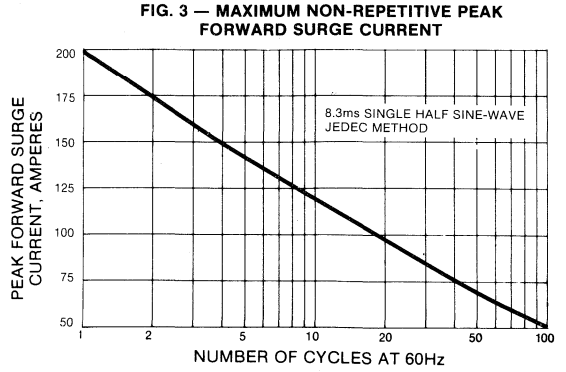
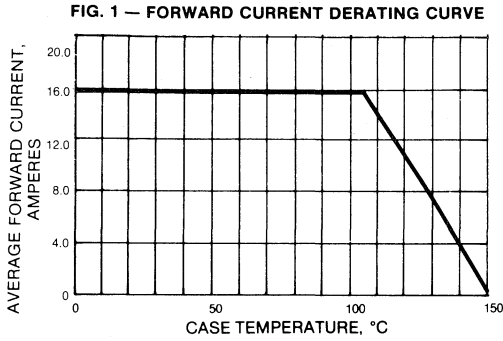
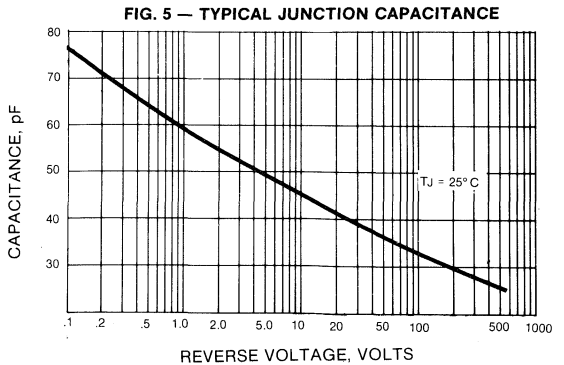
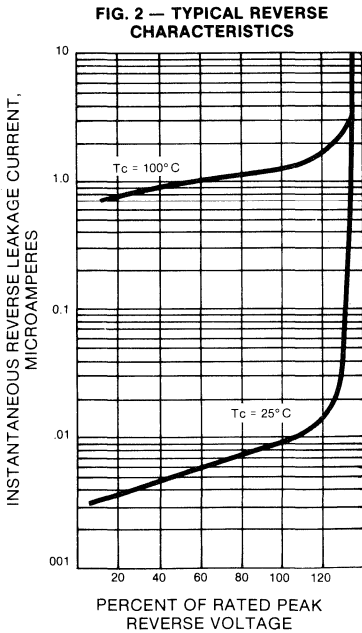
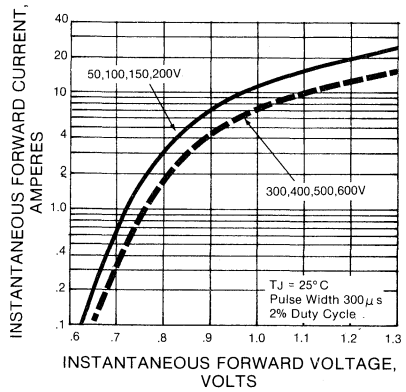

FIG. 4 — TYPICAL INSTANTANEOUS FORWARD CHARACTERISTICS



GI2401 THRU GI2404

GLASS PASSIVATED FAST EFFICIENT RECTIFIER
Voltage - 50 to 200 Volts Current - 16 Amperes

FEATURES

- ◆ Plastic material used carries Underwriters Laboratory Flammability Classification 94V-O
- ◆ Glass passivated cavity-free junction
- ◆ Low power, high efficiency
- ◆ High surge capability
- ◆ Superfast recovery times, high voltage
- ◆ High temperature soldering guaranteed 250°C, .25", 6.35mm from CASE for 10 seconds



TO-220 CT

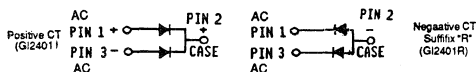
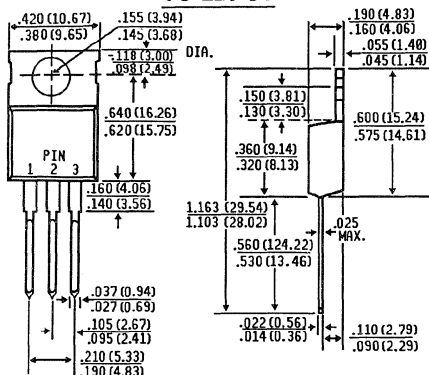

Dimensions in inches and (millimeters)

MECHANICAL DATA

Case: TO-220 molded plastic

Terminals: Lead solderable per MIL-STD-202, Method 208

Polarity: As marked

Mounting Position: Any

Weight: 0.08 ounce, 2.24 gram

MAXIMUM RATINGS AND ELECTRICAL CHARACTERISTICS

Ratings at 25°C ambient temperature unless otherwise specified.
 Resistive or inductive load.
 For capacitive load, derate current by 20%.

	SYMBOLS	GI2401	GI2402	GI2403	GI2404	UNITS
Maximum Recurrent Peak Reverse Voltage	V_{RRM}	50	100	150	200	Volts
Maximum RMS Voltage	V_{RMS}	35	70	105	140	Volts
Maximum DC Blocking Voltage	V_{DC}	50	100	150	200	Volts
Maximum Average Forward Rectified Current at $T_C = 125^\circ\text{C}$	$I_{(AV)}$	16.0				Amps
Peak Forward Surge Current 8.3ms single half sine-wave superimposed on rated load (JEDEC Method)	I_{FSM}	125				Amps
Maximum Instantaneous Forward Voltage $I_F = 4\text{A}, T_J = 100^\circ\text{C}$ $I_F = 8\text{A}, T_J = 100^\circ\text{C}$ $I_F = 4\text{A}, T_J = 25^\circ\text{C}$ $I_F = 8\text{A}, T_J = 25^\circ\text{C}$	V_F	.800 .895 .900 .975				Volts
Maximum DC Reverse Current $T_C = 25^\circ\text{C}$ at Rated DC Blocking Voltage $T_C = 100^\circ\text{C}$	I_R	5.0 150			5.0 500	μA
Maximum Reverse Recovery Time (Note 2)	T_{RR}	35				Ns
Maximum Junction Capacitance (Note 1)	C_J	65				pf
Maximum Thermal Resistance (Note 3)	$R_{\theta JC}$	1.75				$^\circ\text{C}/\text{W}$
Operating and Storage Temperature Range	T_J, T_{STG}	-65 to +150				$^\circ\text{C}$

NOTES:

1. Measured at 1 MHz and applied reverse voltage of 4.0 volts.
2. Reverse Recovery Test Conditions : $I_F = 0.5\text{A}$, $I_R = 1.0\text{A}$, recover to 0.25A.
3. Thermal Resistance Junction to CASE.

RATINGS AND CHARACTERISTIC CURVES GI2401 THRU GI2404

Fig. 1—FORWARD CURRENT DERATING CURVE

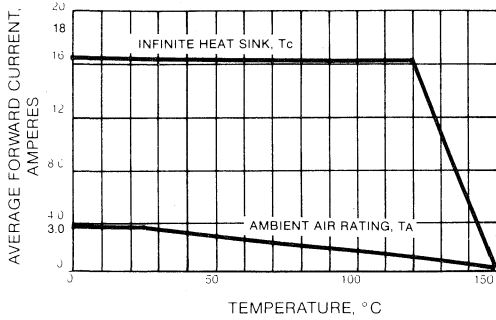

Fig. 2 — MAXIMUM NON-REPETITIVE SURGE CURRENT

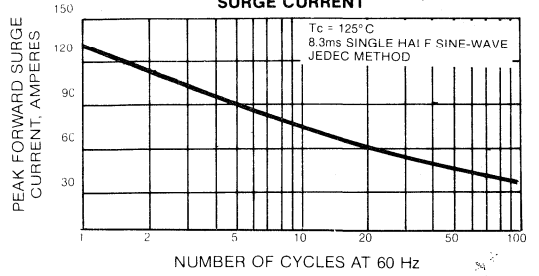

Fig. 4—TYPICAL INSTANTANEOUS FORWARD CHARACTERISTICS

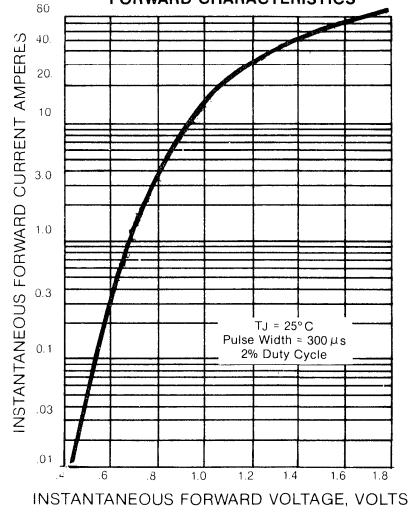

Fig. 3 — TYPICAL REVERSE CHARACTERISTICS

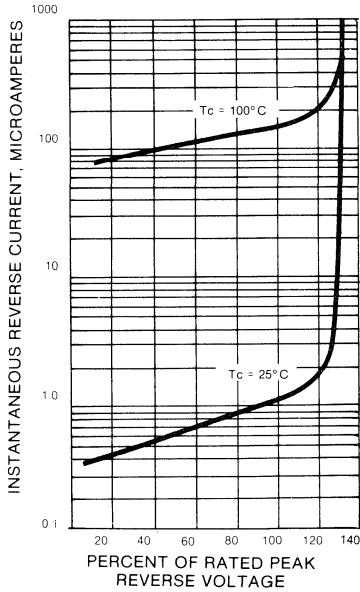
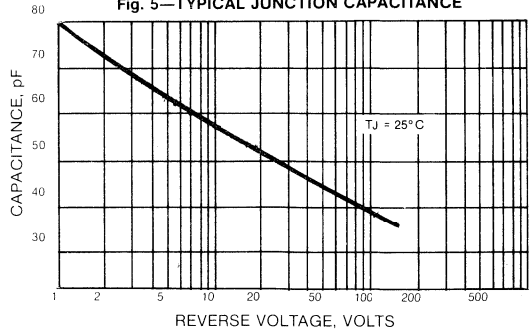

Fig. 5—TYPICAL JUNCTION CAPACITANCE



BYV32-50 THRU BYV32-200

FAST EFFICIENT GLASS PASSIVATED RECTIFIER

Voltage - 50 to 150 Volts Current - 18 Amperes

FEATURES

- ◆ Plastic material used carries Underwriters Laboratory Flammability Classification 94V-0
- ◆ Glass passivated cavity-free junction
- ◆ Low power, high efficiency
- ◆ Low forward voltage high current capability
- ◆ High surge capability
- ◆ Superfast recovery times, high voltage
- ◆ High temperature soldering guaranteed 300°C, 6.35mm from case for 10 seconds

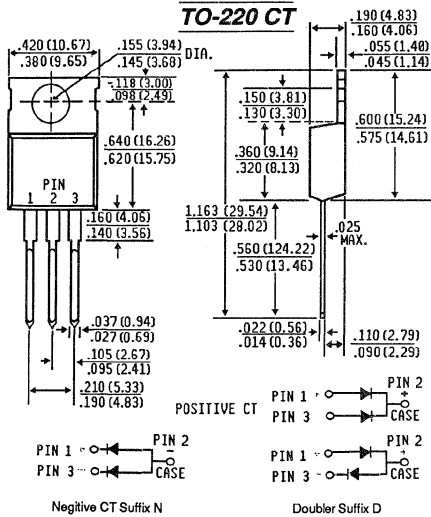
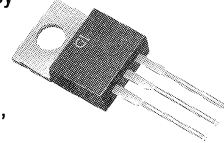

MECHANICAL DATA

Case: TO-220 molded plastic

Terminals: Lead solderable per MIL-STD-202, Method 208

Polarity: As marked

Mounting Position: Any

Weight: 0.08 ounce, 2.24 gram

MAXIMUM RATINGS AND ELECTRICAL CHARACTERISTICS

Ratings at 25°C ambient temperature unless otherwise specified.
Resistive or inductive load.
For capacitive load, derate current by 20%.

	SYMBOLS	BYV32-50	BYV32-100	BYV32-150	BYV32-200	UNITS
Maximum Recurrent Peak Reverse Voltage	V_{RRM}	50	100	150	200	Volts
Maximum RMS Voltage	V_{RMS}	35	70	105	140	Volts
Maximum DC Blocking Voltage	V_{DC}	50	100	150	200	Volts
Maximum Average Forward Rectified Current at $T_C = 120^\circ\text{C}$	$I_{(AV)}$	18.0				Amps
Peak Forward Surge Current 10ms single half sine-wave superimposed $T_J = 150^\circ\text{C}$	I_{FSM}	150				Amps
Maximum Instantaneous Forward Voltage $I_F = 20\text{A}$, $I_F = 5.0\text{A}$, $T_J = 100^\circ\text{C}$	V_F	1.15 0.85				Volts
Maximum DC Reverse Current $T_C = 25^\circ\text{C}$ at Rated DC Blocking Voltage $T_C = 100^\circ\text{C}$	I_R	10.0 600				μA
Maximum Reverse Recovery Time (Note 2) $T_J = 25^\circ\text{C}$	T_{RR}	25				Ns
Typical Junction Capacitance (Note 1)	C_J	45				pf
Maximum Thermal Resistance per diode (Note 3)	$R_{\theta JC}$	3.0				$^\circ\text{C/W}$
Operating and Storage Temperature Range	T_J, T_{STG}	-65 to +150				$^\circ\text{C}$

NOTES:

1. Measured at 1 MHz and applied reverse voltage of 4.0 volts.
2. Reverse Recovery Test Conditions : $I_F = 1\text{A}$ to 30V, with $-di/dt = 100\text{A}/\mu\text{s}$.
3. Thermal Resistance Junction to CASE.

RATINGS AND CHARACTERISTIC CURVES BYV32-50 THRU BYV32-200

FIG. 1 — FORWARD CURRENT DERATING CURVE

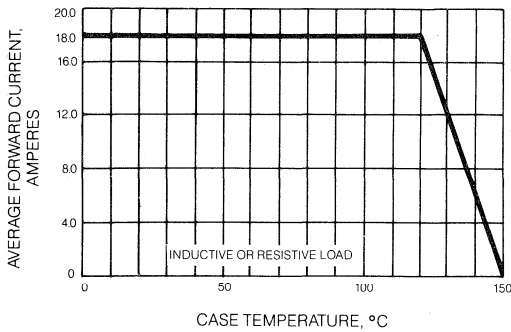

FIG. 2 — MAXIMUM NON-REPETITIVE PEAK FORWARD SURGE CURRENT

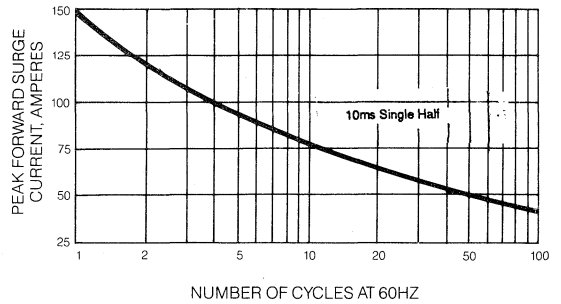

FIG. 4 — TYPICAL INSTANTANEOUS FORWARD CHARACTERISTICS PER ELEMENT

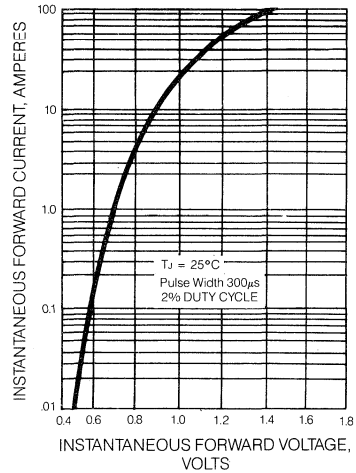

FIG. 3 — TYPICAL REVERSE CHARACTERISTICS

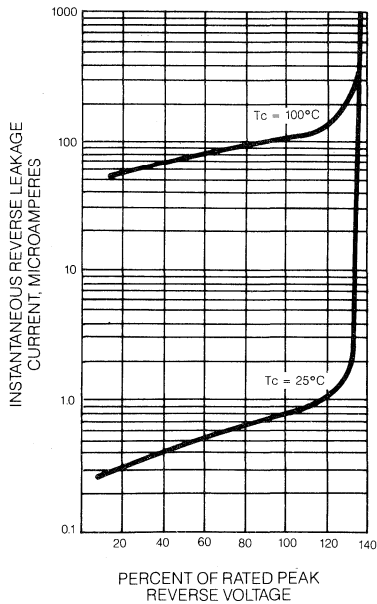
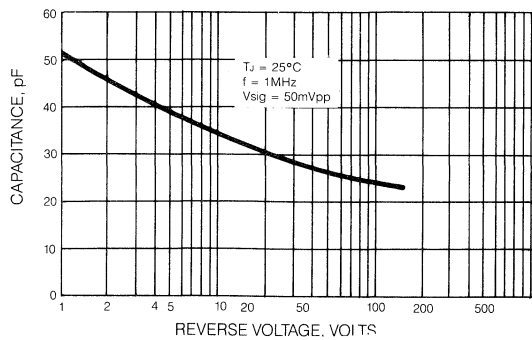

FIG. 5 — TYPICAL JUNCTION CAPACITANCE PER ELEMENT



FEPF30AP THRU FEPF30JP

FAST EFFICIENT GLASS PASSIVATED RECTIFIER

Voltage - 50 to 600 Volts Current - 30 Amperes

FEATURES

- ◆ Dual rectifier construction, positive centertap
- ◆ Isolated plastic material used carries Underwriters Laboratory Flammability Classification 94V-O
- ◆ Glass passivated junctions
- ◆ Superfast recovery times, high voltage
- ◆ Low forward voltage, high current capability
- ◆ Low thermal resistance
- ◆ Low power loss, high efficiency
- ◆ High temperature soldering guaranteed: 250°C, .17", 4.3mm from case for 10 seconds
- ◆ Internal Insulation: 1.5k VRMS

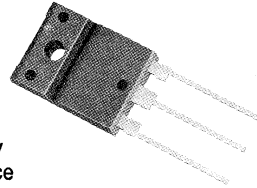

ITO-3P

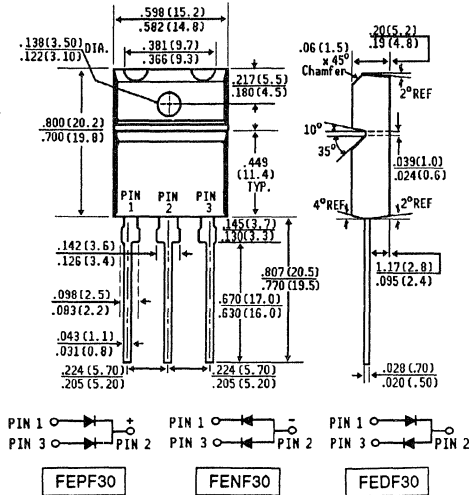

MECHANICAL DATA

Case: ITO-3P Fully overmolded plastic

Terminals: Lead solderable per MIL-STD-202, Method 208

Polarity: As marked

Mounting Position: Any

Mounting Torque: 5 in.-lb. max.

Weight: 0.037 ounce, 1.04 gram

MAXIMUM RATINGS AND ELECTRICAL CHARACTERISTICS

Ratings at 25°C ambient temperature unless otherwise specified. Resistive or inductive load.
For capacitive load, derate current by 20%.

		FEPF 30AP	FEPF 30BP	FEPF 30CP	FEPF 30DP	FEPF 30FP	FEPF 30GP	FEPF 30HP	FEPF 30JP	UNITS
Maximum Recurrent Peak Reverse Voltage	V _{RRM}	50	100	150	200	300	400	500	600	Volts
Maximum RMS Voltage	V _{RMS}	35	70	105	140	210	280	350	420	Volts
Maximum DC Blocking Voltage	V _{DC}	50	100	150	200	300	400	500	600	Volts
Maximum Average Forward Rectified Current See Fig.1	I _(AV)	30.0								Amps
Peak Forward Surge Current 8.3ms single half sine-wave superimposed on rated load (JEDEC Method)	I _{FSM}	300								Amps
Maximum Instantaneous Forward Voltage at 15.0A per element	V _F	0.95		1.3		1.5				Volts
Maximum DC Reverse Current at Rated DC Blocking Voltage	I _R	10.0				500				μA
Maximum Reverse Recovery Time (Note 2) T _J = 25°C	T _{RR}	35		50						Ns
Typical Junction Capacitance (Note 1)	C _J	150								pf
Thermal Resistance (Note 3)	θ _{JC}	1.5								°C/W
Operating and Storage Temperature Range	T _J , T _{STG}	-65 to +150								°C

- NOTES: 1. Measured at 1 MHz and applied reverse voltage of 4.0 volts.
2. Reverse Recovery Test Conditions : I_F = 0.5A, I_R = 1.0A, recover to 0.25A.
3. Thermal Resistance Junction to Case per element.

RATINGS AND CHARACTERISTIC CURVES FEPF30AP THRU FEPF30JP SERIES

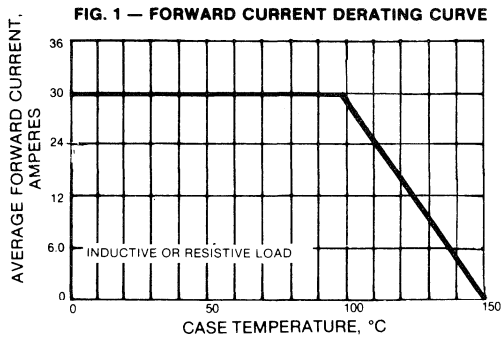

FIG. 3 — MAXIMUM NON-REPETITIVE PEAK FORWARD SURGE CURRENT

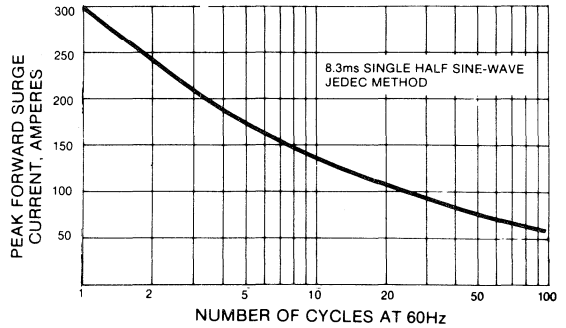

FIG. 2 — TYPICAL INSTANTANEOUS FORWARD CHARACTERISTICS

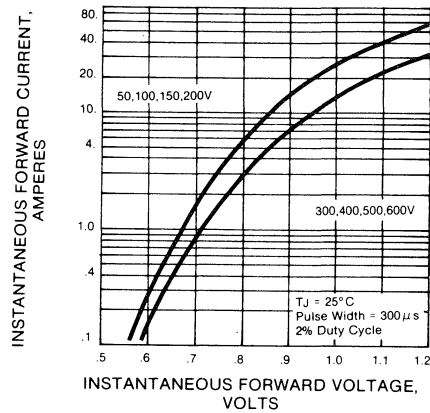

FIG. 2 — TYPICAL REVERSE CHARACTERISTICS

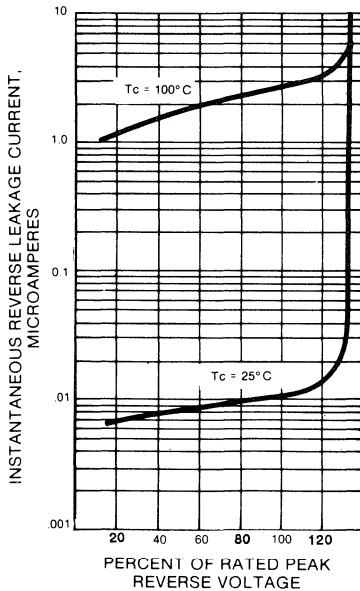
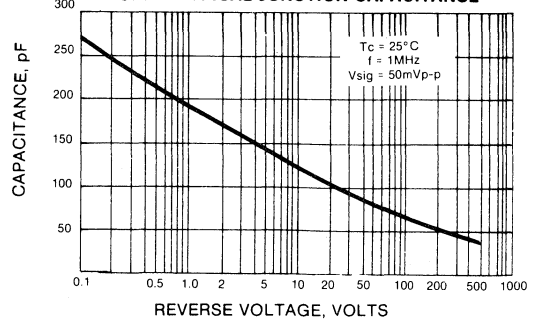

FIG. 5 — TYPICAL JUNCTION CAPACITANCE



FEP30AP THRU FEP30JP

FAST EFFICIENT GLASS PASSIVATED RECTIFIER

Voltage - 50 to 600 Volts Current - 30 Amperes

FEATURES

- ◆ Dual rectifier construction, positive centertap
- ◆ Plastic material used carries Underwriters Laboratory Flammability Classification 94V-0
- ◆ Glass passivated junctions
- ◆ Superfast recovery times, high voltage
- ◆ Low forward voltage, high current capability
- ◆ Low thermal resistance
- ◆ Low power loss, high efficiency
- ◆ High temperature soldering guaranteed: 250°C, .17", 4.3mm from case for 10 seconds

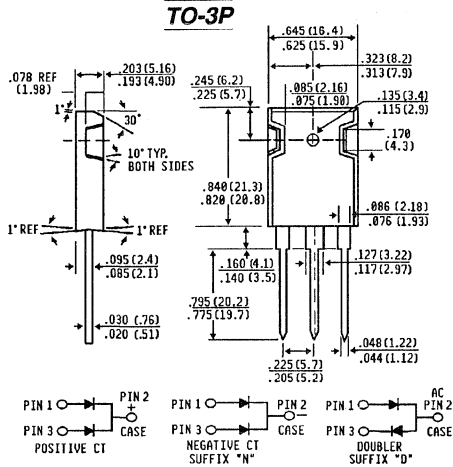
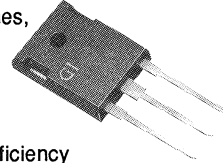

MECHANICAL DATA

Case: TO-3P

Terminals: Lead solderable per MIL-STD-202, Method 208

Polarity: As marked

Mounting Position: Any

Weight: .2 ounces, 5.6 gram

MAXIMUM RATINGS AND ELECTRICAL CHARACTERISTICS

Ratings at 25°C ambient temperature unless otherwise specified.
Resistive or inductive load.
For capacitive load, derate current by 20%.

		FEP 30AP	FEP 30BP	FEP 30CP	FEP 30DP	FEP 30FP	FEP 30GP	FEP 30HP	FEP 30JP	UNITS
Maximum Recurrent Peak Reverse Voltage	V_{RRM}	50	100	150	200	300	400	500	600	Volts
Maximum RMS Voltage	V_{RMS}	35	70	105	140	210	280	350	420	Volts
Maximum DC Blocking Voltage	V_{DC}	50	100	150	200	300	400	500	600	Volts
Maximum Average Forward Rectified Current at $T_C = 100^\circ\text{C}$	$I_{(AV)}$	30.0								Amps
Peak Forward Surge Current 8.3ms single half sine-wave superimposed on rated load (JEDEC Method)	I_{FSM}	300								Amps
Maximum Instantaneous Forward Voltage at 15.0A	V_F	0.95					1.3	1.5		Volts
Maximum DC Reverse Current at Rated DC Blocking Voltage $T_C = 25^\circ\text{C}$	I_R	10.0								μA
Maximum DC Reverse Current at Rated DC Blocking Voltage $T_C = 100^\circ\text{C}$	I_R	500								μA
Maximum Reverse Recovery Time (Note 2) $T_J = 25^\circ\text{C}$	T_{RR}	35			50					Ns
Typical Junction Capacitance (Note 1)	C_J	150								pf
Thermal Resistance (Note 3)	$R_{\theta JC}$	1.0								$^\circ\text{C/W}$
Operating and Storage Temperature Range	T_J, T_{STG}	-65 to +150								$^\circ\text{C}$

NOTES:

1. Measured at 1 MHz and applied reverse voltage of 4.0 volts.
2. Reverse Recovery Test Conditions : $I_F = 0.5\text{A}$, $I_R = 1.0\text{A}$, recover to 0.25A.
3. Thermal Resistance Junction to CASE per element.

RATINGS AND CHARACTERISTIC CURVES FEP30AP THRU FEP30JP

FIG. 1 — FORWARD CURRENT DERATING CURVE

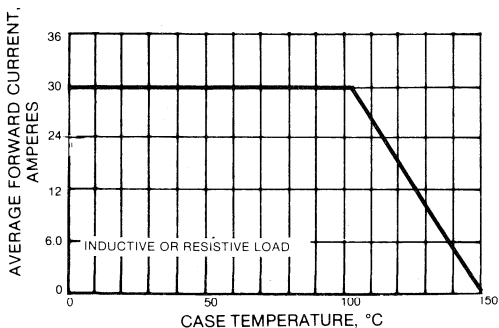

FIG. 3 — MAXIMUM NON-REPETITIVE PEAK FORWARD SURGE CURRENT

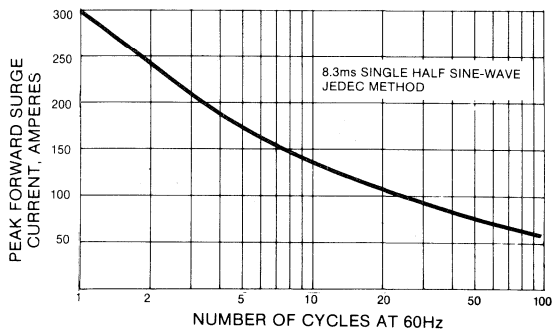

FIG. 2 — TYPICAL INSTANTANEOUS FORWARD CHARACTERISTICS

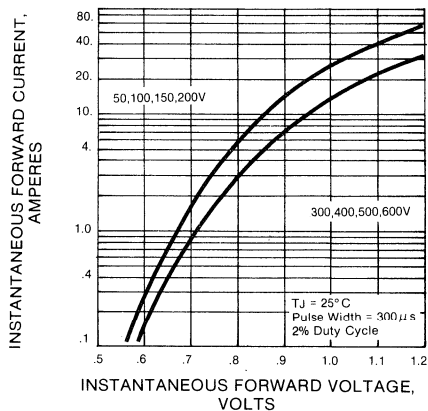

FIG. 2 — TYPICAL REVERSE CHARACTERISTICS

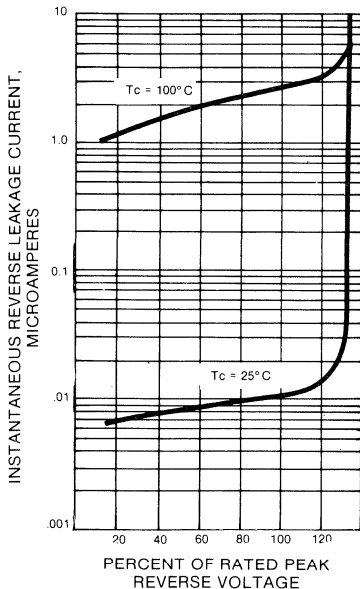
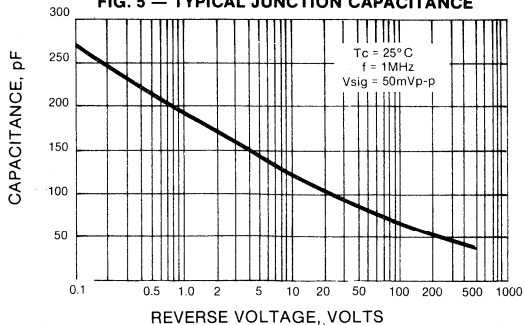

FIG. 5 — TYPICAL JUNCTION CAPACITANCE



SUPERECTIFIERS

***0.25 TO 3.0 AMPERES
50 VOLTS TO 4000 VOLTS***

**GENERAL
INSTRUMENT**

SUPERECTIFIER

.25 to 3.0 Amperes 50 Volts to 4000 Volts

Introduction

No other .25 to 3.0 Ampere rectifiers of any kind— plastic, glass, or metal— can match (or even approach) SUPERECTIFIER's combination of features...the result of General Instrument's unique glass-plastic construction:

- ◆ Brazed at greater than 600°C at both leads and cell — eliminates all soft solders
- ◆ Exclusive UL recognized *flame-retardant* epoxy molding compound rated 94V-0, the highest available
- ◆ Patented glass passivation
- ◆ Reliability proved equal to military requirements
- ◆ Hermetically sealed construction
- ◆ Cost effective construction at plastic prices

General Instrument's SUPERECTIFIER is exactly that...a super rectifier. There is nothing else in the world like it.

In cell construction, most other rectifiers rated up to 3.0 Amperes are **soft soldered** or are only **pressure contacted**. SUPERECTIFIER is made into an entirely solid unit with its leads and cell brazed at temperatures greater than 600°C. All other rectifiers fail at half that temperature.

In cell protection, conventional plastic rectifiers use either varnish, silicon rubber or a thin film of silicon oxide to protect the junction. SUPERECTIFIER uses a patented glass passivation to seal its junction hermetically.

In device encapsulation, again SUPERECTIFIER is the only one that won't go up in flames. It is one of the few rectifiers using an exclusive **flame-RETARDANT** molding compound, rated UL 94V-0, the highest rating available. Other plastic rectifiers use **flame-ENHANCING** compounds. Here again, SUPERECTIFIER's superiority is manifest. With this construction it exceeds environmental standards of MIL-S-19500.

In summary, SUPERECTIFIER is the world's only rectifier with totally brazed construction, with a patented glass passivated junction, and with flame-retardant molding encapsulation.

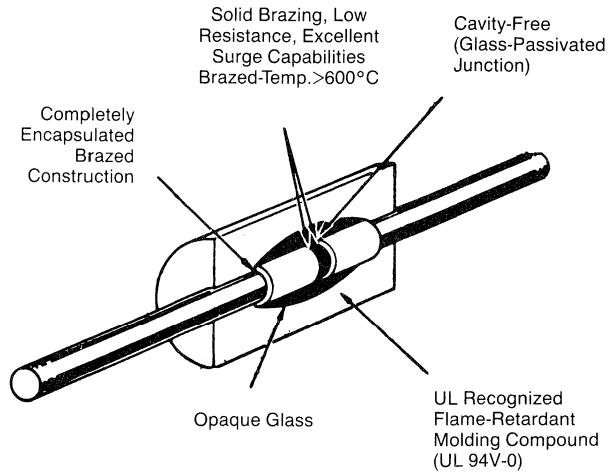

FAMILIES OF GENERAL INSTRUMENT SUPERECTIFIER

Glass Passivated Junction Plastic Rectifiers 0.25 to 1.75 AMPERES

Types: 1N3611GP thru 1N3614GP BY126GP and BY127GP
 1N4001GP thru 1N4007GP BY126GP and BY227GP
 1N4245GP thru 1N4249GP BY133GP thru BY135GP
 1N5059GP thru 1N5062GP BYW27-50GP thru BYW27-1000GP
 1N5391GP thru 1N5399GP BYX10GP
 GI250-1 thru GI250-4
 GP02-20 thru GP02-40
 GP08A thru GP08J
 GP10A thru GP10Y
 GP15A thru GP15M

Features:

- ◆ High Temperature Metallurgically Bonded
- ◆ Plastic Package has Underwriters Laboratory Classification 94V-0
- ◆ Glass Passivated Junction overmolded in epoxy packages for easy handling
- ◆ I_O rated current operation at 55°C Ambient Temperature with no Thermal Runaway.
- ◆ Capable of meeting Environmental Standards of MIL-S-19500
- ◆ High Temperature Soldering Guaranteed 350°C/10 Second/.375" 9.5mm Lead Length at 5 lbs. 2.25 kg Tension
- ◆ Tin Plated Axial Leads, Solderable per MIL-STD-202 method 208

Glass Passivated Junction Plastic Rectifiers 2.0 to 3.0 AMPERES

Types: 1N5624GP thru 1N5627GP
 GP20A thru GP20J
 GP25A thru GP25M
 GP30A thru GP30M

Features:

- ◆ High Temperature Metallurgically Bonded
- ◆ Plastic Package has Underwriters Laboratory Classification 94V-0
- ◆ Glass Passivated Junction overmolded in epoxy packages for easy handling
- ◆ I_O rated current operation at 55°C Ambient Temperature with no Thermal Runaway
- ◆ Typical I_n less than 0.1 μ A
- ◆ Capable of meeting Environmental Standards of MIL-S-19500
- ◆ Tin Plated Axial Leads, Solderable per MIL-STD-202 method 208
- ◆ High Temperature Soldering Guaranteed 350°C/10 Second/.375" 9.5mm Lead Length at 5 lbs. 2.25 kg Tension

Fast Recovery Glass Passivated Junction Plastic Rectifiers 0.50 to 3.0 AMPERES

Types: 1N4942GP thru 1N4948GP RGP30A thru RGP30M
 RGPO2-12 thru RGPO2-20 BA157GP thru BA159GP
 RGP10A thru RGP10M BY206GP and BY207GP
 RGP15A thru RGP15M
 RGP20A thru RGP20J
 RGP25A thru RGP25M

Features:

- ◆ High Temperature Metallurgically Bonded
- ◆ Fast switching for High Rectification Efficiency to 100kHz
- ◆ Plastic Package has Underwriters Laboratory Classification 94V-0
- ◆ Capable of meeting Environmental Standards of MIL-S-19500
- ◆ Includes all Advantages of the SUPERECTIFIER Design
- ◆ Tin Plated Axial Leads, Solderable per MIL-STD-202 method 208
- ◆ High Temperature Soldering Guaranteed: 350°C/10 Second/.375" 9.5mm Lead Length at 5 lbs. 2.25 kg Tension

**GENERAL
INSTRUMENT**

QUICK GUIDE TO SUPERECTIFIERS

TYPE	RGP01* -12 thru -20	GP02 -20 thru -40	GI250 -1 thru -4	BYX10GP		BY206GP* thru BY207GP*	BA157GP* thru BA159GP*	GP08A thru GP08J	GP10A thru GP10M	1N3611GP thru 1N3614GP	1N4001GP thru 1N4007GP	1N4245GP thru 1N4249GP	1N4933GP* thru 1N4937GP*
CASE	DO41	DO41	DO41	DO41		DO41	DO41	DO41	DO41	DO41	DO41	DO41	DO41
I _o (A)	0.5	0.25	0.25	.36		0.4	0.5	0.8	1.0	1.0	1.0	1.0	1.0
@T _A (°C)	55	55	75	40		55	55	55	55	100	75	55	75
V _R = 1000 (V)			GI250-1		V _R = 50 (V)			GP08A	GP10A		1N4001GP		1N4933GP
V _R = 1200 (V)	RG02-12				V _R = 100 (V)			GP08B	GP10B		1N4002GP		1N4934GP
V _R = 1400 (V)	RG02-14				V _R = 200 (V)			GP08D	GP10D	1N3611GP	1N4003GP	1N4245GP	1N4935GP
V _R = 1600 (V)	RG02-16			BYX10GP	V _R = 300 (V)			GP08G					
V _R = 1800 (V)	RG02-18				V _R = 400 (V)	BY206GP	BA157GP		GP10G	1N3612GP	1N4004GP	1N4246GP	1N4936GP
V _R = 2000 (V)	RG02-20	GP02 -20	GI250 -2		V _R = 500 (V)			GP08J					
V _R = 2500 (V)		GP02 -25			V _R = 600 (V)	BY207GP	BA158GP		GP10J	1N3613GP	1N4005GP	1N4247GP	1N4937GP
V _R = 3000 (V)		GP02 -30	GI250 -3		V _R = 800 (V)		BA159DGP		GP10K	1N3614GP	1N4006GP	1N4248GP	
V _R = 3500 (V)		GP02 -35			V _R = 1000 (V)		BA159GP		GP10M	1N3957GP	1N4007GP	1N4249GP	
V _R = 4000 (V)		GP02 -40	GI250 -4										
SURGE (A)	20	15	15	15		15	20	25	30	30	30	25	30
V _F (V)	1.8	3.0	3.5	1.6		1.3	1.3	1.3	1.1	1.1	1.1	1.2	1.2

*Fast Recovery

QUICK GUIDE TO SUPERECTIFIERS

TYPE	1N4383GP thru 1N4586GP	1N5059GP thru 1N5062GP	AGP15-200 thru AGP15-800	GP15A thru GP15M	1N5391GP thru 1N5399GP	BY126GP thru BY127GP	RGP15A* thru RGP15M*	BY226GP thru BY227GP	GP20A thru GP20J	RGP20A thru RGP20J *	RGP25A thru RGP25M*	1N5624GP thru 1N5627GP	GP30A thru GP30M	RGP30A* thru RGP30M*
CASE	DO15	DO15	DO15	DO15	DO15	DO201AE	DO15	DO201AE	GP20	GP20	DO201AD	DO201AD	DO201AD	DO201AD
I _o (A)	1.0	1.0	1.5	1.5	1.5	1.5	1.5	1.75	2.0	2.0	2.5	3.0	3.0	3.0
@T _A (°C)	5	55	55	55	70	55	55	55	55	55	55	70	55	55
V _R = 50 (V)				GP15A	1N5391GP		RGP15A		GP20A	RGP20A	RGP25A		GP30A	RGP30A
V _R = 100 (V)				GP15B	1N5392GP		RGP15B		GP20B	RGP20B	RGP25B		GP30B	RGP30B
V _R = 200 (V)	1N4383GP	1N5059GP	AGP15-200	GP15D	1N5393GP		RGP15D		GP20D	RGP20D	RGP25D	1N5624GP	GP30D	RGP30D
V _R = 300 (V)					1N5394GP									
V _R = 400 (V)	1N4384GP	1N5060GP	AGP15-400	GP15G	1N5395GP		RGP15G		GP20G	RGP20G	RGP25G	1N5625GP	GP30G	RGP30G
V _R = 500 (V)					1N5396GP									
V _R = 600 (V)	1N4384GP	1N5061GP	AGP15-600	GP15J	1N5397GP	BY126GP	RGP15J	BY226GP	GP20J	RGP20J	RGP25J	1N5626GP	GP30J	RGP30J
V _R = 800 (V)	1N4585GP	1N5062GP	AGP15-800	GP15K	1N5398GP		RGP15K				RGP25K	1N5627GP	GP30K	RGP30K
V _R = 1000 (V)	1N4586GP			GP15M	1N5399GP		RGP15M				RGP25M		GP30M	RGP30M
V _R > 1000 (V)						BY127GP		BY227GP						
SURGE (A)	50	50	50	50	50	50	50	60	65	65	100	125	125	125
V _F (V)	1.2	1.2	1.2	1.1	1.4	1.3	1.3	1.3	1.1	1.3	1.3	1.0	1.1	1.3

*Fast Recovery

**GENERAL
INSTRUMENT**

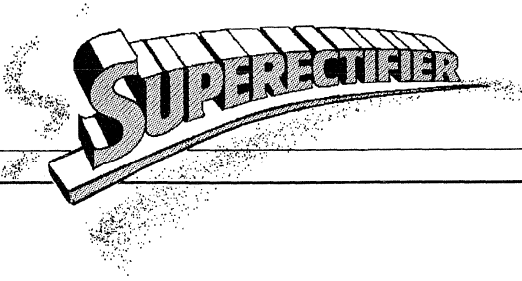

GLASS RECTIFIER PROCESS

Diffused Slice

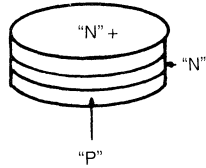

1—Diffuse a PN junction into a slice of silicon.

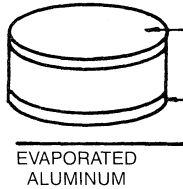

2—Evaporate aluminum on both sides of the slice to make metallurgical contact.

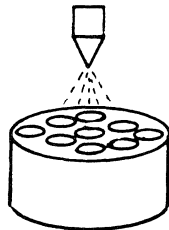

SAND BLASTED
ROUND DICE

3—Sandblast the slice to produce a round beveled die.

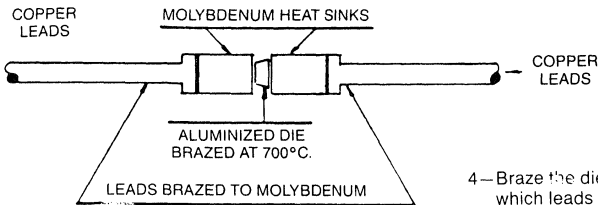

4—Braise the die between two molybdenum heat sinks to which leads have been attached at approximately 700°C.

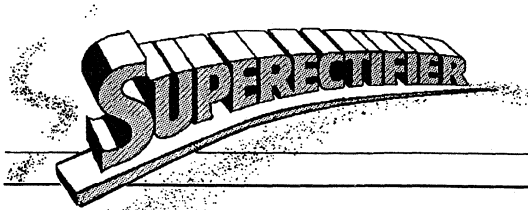

GLASS RECTIFIER PROCESS

- 5—Clean the assembly by chemically etching, washing and drying.
- 6—Apply glass in the form of a frit to the die and molybdenum assembly.
- 7—Melt the glass by heating in an oven to approximately 600°C.
- 8—Overmold glass passivated construction with UL recognized flame-retardant 94V-0 classification epoxy.
- 9—Perform finishing operations such as lead tinning, electrical testing and marking.

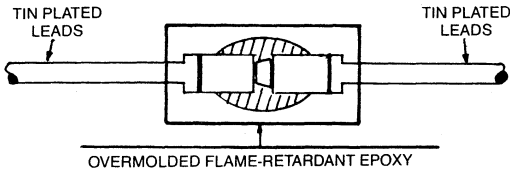
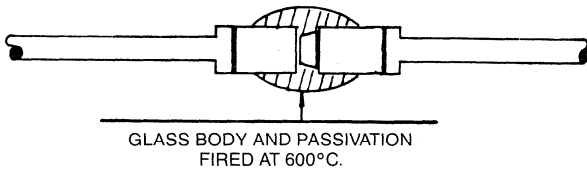

Package Design

The small size of the superectifier package with its capability up to 3 Amperes permits greater packing densities in electronic assemblies and equipment, while increasing reliability. Furthermore, only high temperature brazing operations are used to withstand the 600°C required to melt and fuse the glass. This technique eliminates solder construction and tremendously enhances mechanical strength and temperature cycling capability, increasing operating and storage temperature range while reducing thermal resistance.

Reliability

Specified reliability data on Superectifier devices are available from the General Instrument Semiconductor Components Division Reliability Department. The basic design of the superectifier devices and the strict positive controls over materials and manufacturing processes provide assurance of failure-free performance under the most severe conditions. Processing facilities have been geared to follow the procedural requirements of Military Standard 750 and are capable of withstanding environmental extremes in excess of MIL-S-19500. Assurance of production uniformity and reliability is provided by a test technique called "Operational Load Line Testing," which has proven product reliability with over 1 Billion Superectifiers now in use.

**GENERAL
INSTRUMENT**

GP02-20 THRU GP02-40

MINIATURE HIGH VOLTAGE GLASS PASSIVATED JUNCTION RECTIFIER

Voltage - 2000 to 4000 Volts Current - 0.25 Amperes

FEATURES

PATENTED*

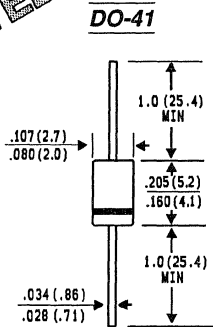

Dimensions in inches and (millimeters)

* Glass-plastic encapsulation technique is covered by Patent No. 3,996,602 of 1976; brazed-lead assembly to Patent No. 3,930,306 of 1976 and glass composition by Patent No. 3,752,701 of 1973

- ◆ High temperature metallurgically bonded constructed rectifiers
- ◆ Plastic package has Underwriters Laboratory Flammability Classification 94V-0
- ◆ Glass passivated cavity-free junction in DO-41 package
- ◆ Capable of meeting environmental standards of MIL-S-19500
- ◆ High temperature soldering guaranteed: 350°C/10 seconds/.375", (9.5mm) lead length at 5 lbs., (2.3kg) tension

MECHANICAL DATA

Case: Molded plastic over glass

Terminals: Axial leads, solderable per MIL-STD-202, Method 208

Polarity: Color band denotes cathode

Mounting Position: Any

Weight: 0.012 ounce, .3 gram

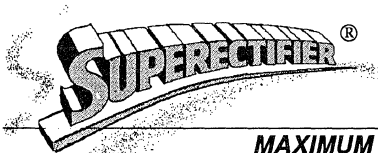

MAXIMUM RATINGS AND ELECTRICAL CHARACTERISTICS

Ratings at 25°C ambient temperature unless otherwise specified. Resistive or inductive load. For capacitive load, derate current by 20%.

	SYMBOLS	GP02 -20	GP02 -25	GP02 -30	GP02 -35	GP02 -40	UNITS
Maximum Recurrent Peak Reverse Voltage	V _{RRM}	2000	2500	3000	3500	4000	Volts
Maximum RMS Voltage	V _{RMS}	1400	1750	2100	2450	2800	Volts
Maximum DC Blocking Voltage	V _{DC}	2000	2500	3000	3500	4000	Volts
Maximum Average Forward Rectified Current .375", (9.5mm) Lead Lengths at T _A = 55°C	I _(AV)	0.25					Amps
Peak Forward Surge Current 8.3ms single half sine-wave superimposed on rated load at T _A = 55°C	I _{FSM}	15					Amps
Maximum Instantaneous Forward Voltage at 1.0A	V _F	3.0					Volts
Maximum DC Reverse Current T _A = 25°C at Rated DC Blocking Voltage T _A = 100°C	I _R	5.0 50.0					μA
Typical Reverse Recovery Time (Note 2)	T _{RR}	2.0					μs
Typical Junction Capacitance (Note 1)	C _J	3.0					pf
Typical Thermal Resistance (Note 3)	R _{θJA}	130					°C/W
Operating and Storage Temperature Range	T _J , T _{STG}	-65 to +175					°C

NOTES:

1. Measured at 1 MHz and applied reverse voltage of 4.0 Volts.
2. Reverse Recovery Test Conditions : I_F = 0.5A, I_R = 1.0A, I_{rr} = .25A.
3. Thermal Resistance from Junction to Ambient at .375" (9.5mm) Lead Lengths, P.C. Board Mounted.

RATINGS AND CHARACTERISTIC CURVES GP02-20 THRU GP02-40

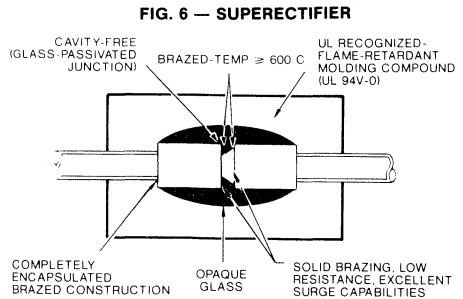
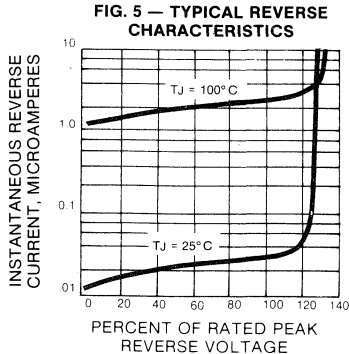
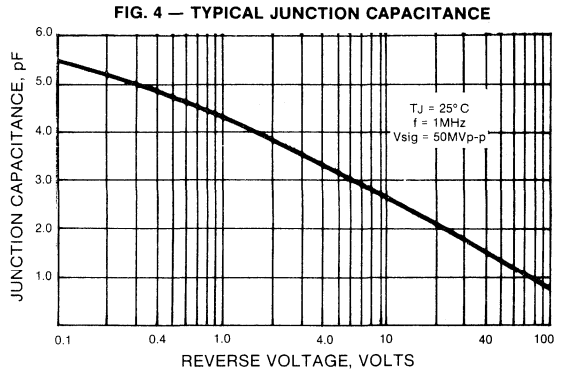
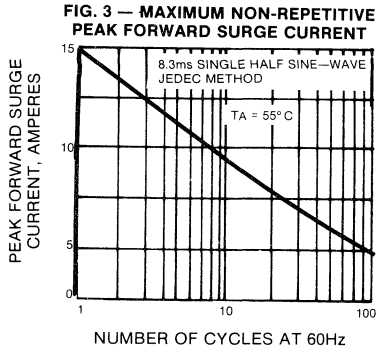
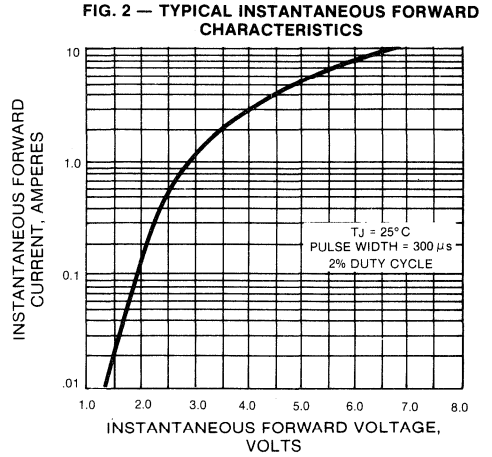
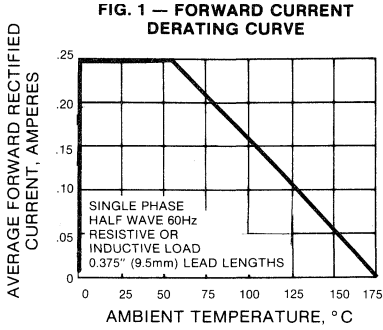

GI250-1 THRU GI250-4

MINIATURE HIGH VOLTAGE GLASS PASSIVATED JUNCTION RECTIFIER

Voltage - 1000 to 4000 Volts Current - 0.25 Amperes

FEATURES

- ◆ High temperature metallurgically bonded constructed rectifiers
- ◆ Plastic package has Underwriters Laboratory Flammability Classification 94V-0
- ◆ Glass passivated cavity-free junction in D0-41 package
- ◆ Capable of meeting environmental standards of MIL-S-19500
- ◆ High temperature soldering guaranteed: 350°C/10 seconds/.375", (9.5mm) lead length at 5 lbs., (2.3kg) tension

PATENTED*

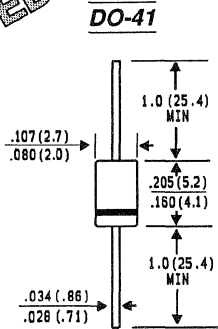

Dimensions in inches and (millimeters)

* Glass-plastic encapsulation technique is covered by Patent No. 3,996,602 of 1976; brazed-lead assembly to Patent No. 3,930,306 of 1976 and glass composition by Patent No. 3,752,701 of 1973



MECHANICAL DATA

- Case:** Molded plastic over glass
Terminals: Axial leads, solderable per MIL-STD-202, Method 208
Polarity: Color band denotes cathode
Mounting Position: Any
Weight: 0.012 ounce, .3 gram

MAXIMUM RATINGS AND ELECTRICAL CHARACTERISTICS

Ratings at 25°C ambient temperature unless otherwise specified. Resistive or inductive load.
 For capacitive load, derate current by 20%.

	SYMBOLS	GI250-1	GI250-2	GI250-3	GI250-4	UNITS
Maximum Recurrent Peak Reverse Voltage	V_{RRM}	1000	2000	3000	4000	Volts
Maximum RMS Voltage	V_{RMS}	700	1400	2100	2800	Volts
Maximum DC Blocking Voltage	V_{DC}	1000	2000	3000	4000	Volts
Maximum Average Forward Rectified Current .375", (9.5mm) Lead Lengths at $T_A = 75^\circ\text{C}$	$I_{(AV)}$	0.25				Amps
Peak Forward Surge Current 8.3ms single half sine-wave superimposed on rated load at $T_A = 75^\circ\text{C}$	I_{FSM}	15.0				Amps
Maximum Instantaneous Forward Voltage at 0.25A	V_F	3.5				Volts
Maximum DC Reverse Current $T_A = 25^\circ\text{C}$ at Rated DC Blocking Voltage $T_A = 100^\circ\text{C}$	I_R	5.0 50.0				μA
Typical Reverse Recovery Time (Note 2)	T_{RR}	2.0				μs
Typical Junction Capacitance (Note 1)	C_J	3.0				pf
Typical Thermal Resistance (Note 3)	$R_{\theta JA}$	130				$^\circ\text{C/W}$
Operating and Storage Temperature Range	T_J, T_{STG}	-65 to +175				$^\circ\text{C}$

NOTES:

1. Measured at 1 MHz and applied reverse voltage of 4.0 Volts.
2. Reverse Recovery Test Conditions : $I_F = 0.5\text{A}$, $I_R = 1.0\text{A}$, $I_{rr} 0.25\text{A}$.
3. Thermal Resistance from Junction to Ambient at .375" (9.5mm) Lead Lengths, P.C. Board Mounted.

RATINGS AND CHARACTERISTIC CURVES GI250-1 THRU GI250-4

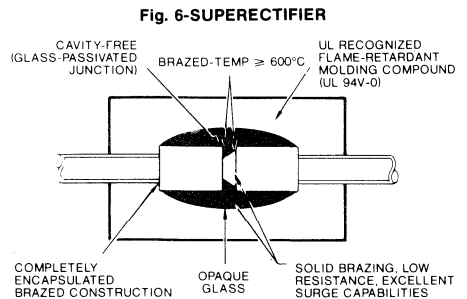
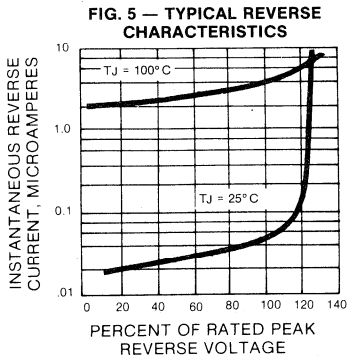
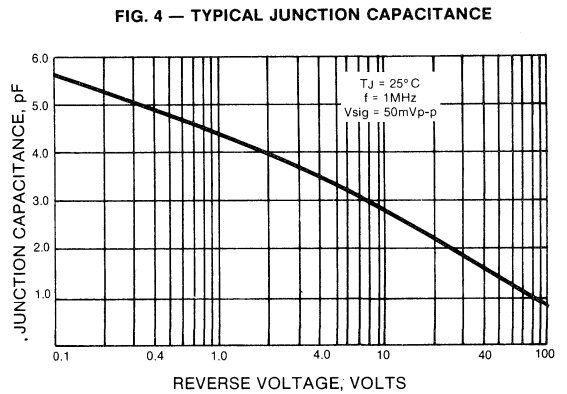
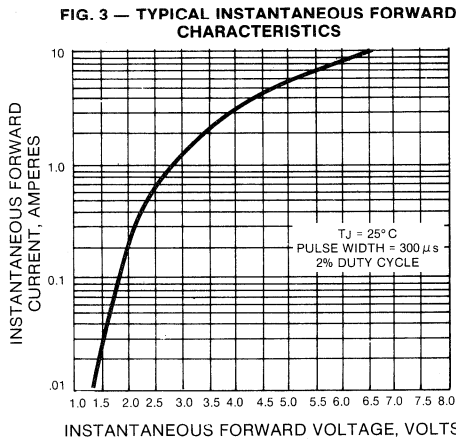
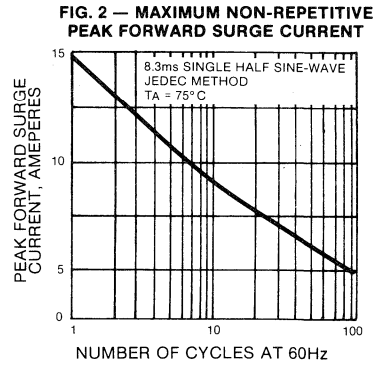
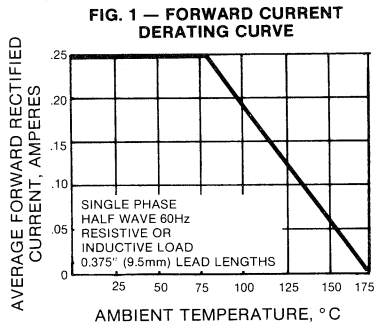

BYX10GP

MINIATURE GLASS PASSIVATED JUNCTION PLASTIC RECTIFIER

Voltage - 1600 Volts Current - .36 Amperes

FEATURES

- ◆ High temperature metallurgically bonded constructed rectifier
- ◆ Plastic package has Underwriters Laboratory Flammability Classification 94V-0
- ◆ Glass passivated cavity-free junction in D0-41 package
- ◆ .36 Ampere operation at $T_A = 40^\circ\text{C}$ with no thermal runaway
- ◆ Typical I_R less than $0.1 \mu\text{A}$
- ◆ Capable of meeting environmental standards of MIL-S-19500
- ◆ High temperature soldering guaranteed $350^\circ\text{C}/10$ seconds/.375", (9.5mm) lead length at 5 lbs., (2.3kg) tension

PATENTED*

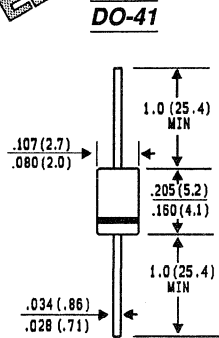

Dimensions in inches and (millimeters)

* Glass-plastic encapsulation technique is covered by Patent No. 3,996,602 of 1976; brazed lead assembly to Patent No. 3,930,306 of 1976 and glass composition by Patent No. 3,752,701 of 1973

MECHANICAL DATA

- Case:** Molded plastic over glass
Terminals: Axial leads, solderable per MIL-STD-202, Method 208
Polarity: Color band denotes cathode
Mounting Position: Any
Weight: 0.012 ounce, .3 gram



MAXIMUM RATINGS AND ELECTRICAL CHARACTERISTICS

Ratings at 25°C ambient temperature unless otherwise specified.
 Resistive or inductive load.
 For capacitive load, derate current by 20%.

	SYMBOLS	BYX10GP	UNITS
Maximum Recurrent Peak Reverse Voltage	V_{RRM}	1600	Volts
Maximum Working Reverse Voltage	V_{RMS}	800	Volts
Maximum Average Forward Rectified Current .375", (9.5mm) Lead Lengths at $T_A = 40^\circ\text{C}$	$I_{(AV)}$	0.36	Amps
Peak Forward Surge Current 10ms single half sine-wave superimposed on rated load	I_{FSM}	15	Amps
Maximum Instantaneous Forward Voltage at 2.0A	V_F	1.6	Volts
Maximum Peak Reverse Current at Rated Peak Working Reverse Voltage $T_A = 25^\circ\text{C}$	I_R	1.0	μA
Maximum Reverse Recovery Time (Note 1)	T_{RR}	2.0	μs
Typical Junction Capacitance (Note 2)	C_J	5.0	pf
Typical Thermal Resistance (Note 3)	$R_{\theta JA}$	45.0	$^\circ\text{C}/\text{W}$
Operating and Storage Temperature Range	T_J, T_{STG}	-65 to +175	$^\circ\text{C}$

NOTES:

1. Measured on $I_F = 0.5\text{A}$, $I_R = 1.0\text{A}$, $I_{rr} = 0.25\text{A}$.
2. Measured at 1.0 MHz and applied reverse voltage of 4.0 Volts.
3. Thermal Resistance from Junction to Ambient at .375" (9.5mm) Lead Lengths, P.C. Board Mounted.

RATINGS AND CHARACTERISTIC CURVES BYX10GP SERIES

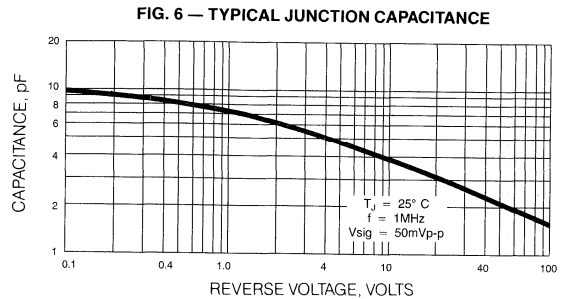
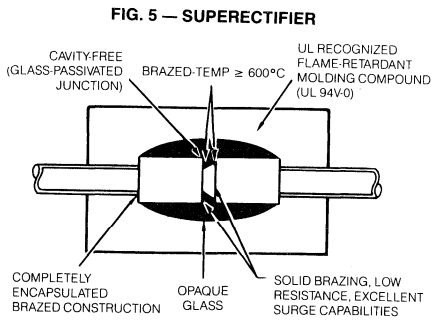
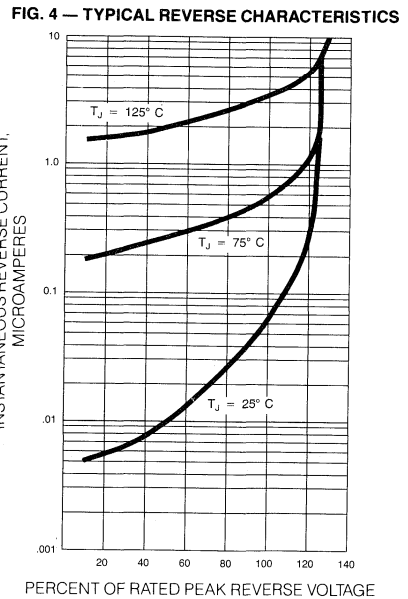
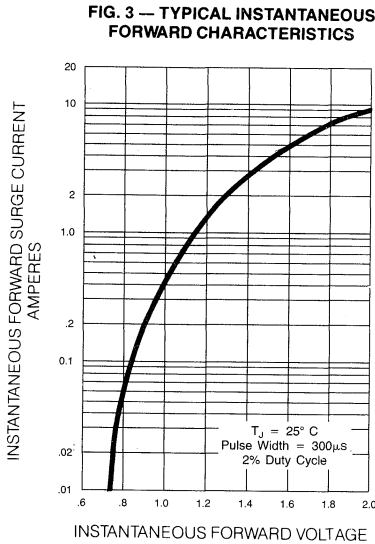
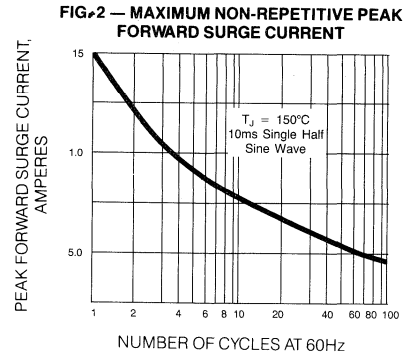
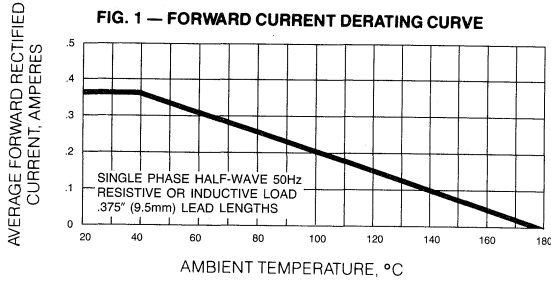

GP08A THRU GP08J

MINIATURE GLASS PASSIVATED JUNCTION PLASTIC RECTIFIER

Voltage - 50 to 600 Volts Current - 0.8 Amperes

FEATURES

- ◆ High temperature metallurgically bonded constructed rectifiers
- ◆ Plastic package has Underwriters Laboratory Flammability Classification 94V-0
- ◆ Fast switching for high efficiency
- ◆ Glass passivated cavity-free junction in D0-41 package
- ◆ 0.8 Ampere operation at $T_A = 55^\circ\text{C}$ with no thermal runaway
- ◆ Typical I_R less than $0.1 \mu\text{A}$
- ◆ Capable of meeting environmental standards of MIL-S-19500
- ◆ High temperature soldering guaranteed $350^\circ\text{C}/10$ seconds/.375", (9.5mm) lead length at 5 lbs., (2.3kg) tension

PATENTED*

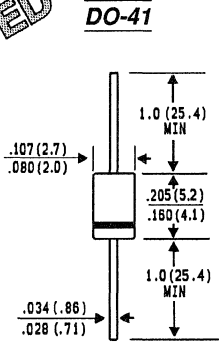

Dimensions in inches and (millimeters)

* Glass-plastic encapsulation technique is covered by Patent No. 3,996,602 of 1976; brazed-lead assembly to Patent No. 3,930,306 of 1976 and glass composition by Patent No. 3,752,701 of 1973



MECHANICAL DATA

- Case:** Molded plastic over glass
Terminals: Axial leads, solderable per MIL-STD-202, Method 208
Polarity: Color band denotes cathode
Mounting Position: Any
Weight: 0.012 ounce, .3 gram

MAXIMUM RATINGS AND ELECTRICAL CHARACTERISTICS

Ratings at 25°C ambient temperature unless otherwise specified. Resistive or inductive load. For capacitive load, derate current by 20%.

	SYMBOLS	GP08A	GP08B	GP08D	GP08G	GP08J	UNITS
Maximum Recurrent Peak Reverse Voltage	V_{RRM}	50	100	200	400	600	Volts
Maximum RMS Voltage	V_{RMS}	35	70	140	280	420	Volts
Maximum DC Blocking Voltage	V_{DC}	50	100	200	400	600	Volts
Maximum Average Forward Rectified Current .375", (9.5mm) Lead Lengths at $T_A = 55^\circ\text{C}$	$I_{(AV)}$	0.8					Amps
Peak Forward Surge Current 8.3ms single half sine-wave superimposed on rated load (JEDEC Method)	I_{FSM}	25.0					Amps
Maximum Instantaneous Forward Voltage at 0.8A	V_F	1.3					Volts
Maximum Full Load Reverse Current Full Cycle Average at $T_A = 55^\circ\text{C}$	$I_{R(AV)}$	30.0					μA
Maximum DC Reverse Current at Rated DC Blocking Voltage $T_A = 25^\circ\text{C}$ $T_A = 125^\circ\text{C}$	I_R	5.0 50.0					μA
Typical Reverse Recovery Time (Note 1)	T_{RR}	1.0					μS
Typical Junction Capacitance (Note 2)	C_J	8.0					pf
Typical Thermal Resistance (Note 3)	$R_{\theta JA}$	45.0					$^\circ\text{C/W}$
Operating and Storage Temperature Range	T_J, T_{STG}	-65 to +175					$^\circ\text{C}$

NOTES:

1. Measured on $I_F = 0.5\text{A}$, $I_R = 1.0\text{A}$, $I_{rr} = .25\text{A}$.
2. Measured at 1.0 MHz and applied reverse voltage of 4.0 Volts.
3. Thermal Resistance from Junction to Ambient at .375" (9.5mm) Lead Lengths, P.C. Board Mounted.

RATINGS AND CHARACTERISTIC CURVES GP08A THRU GP08J

FIG. 1 — FORWARD CURRENT DERATING CURVE

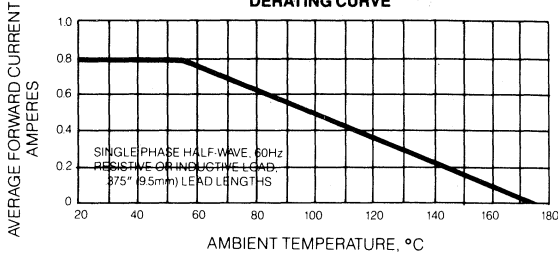

FIG. 2 — TYPICAL INSTANTANEOUS FORWARD CHARACTERISTICS

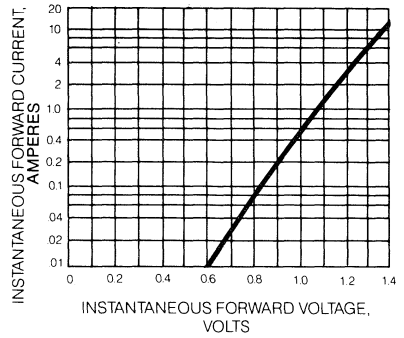

FIG. 3 — MAXIMUM NON-REPETITIVE PEAK FORWARD SURGE CURRENT

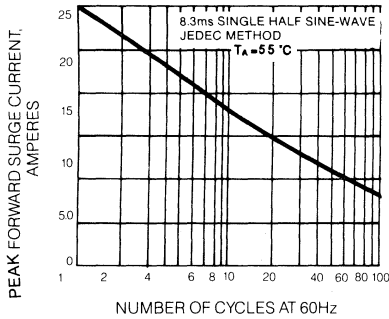

FIG. 4 — TYPICAL JUNCTION CAPACITANCE

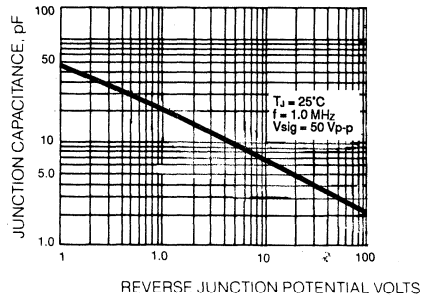

FIG. 5 — TYPICAL REVERSE CHARACTERISTICS

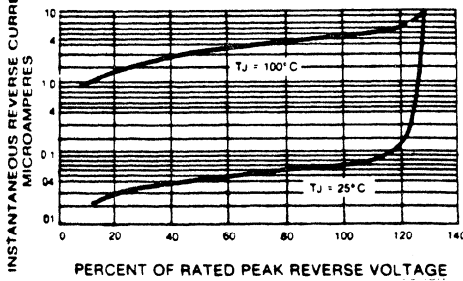
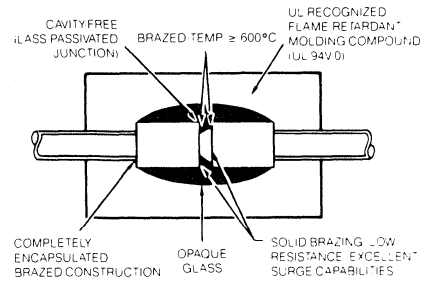

FIG. 6 — GI SUPERRECTIFIER



1N3611GP THRU 1N3614GP AND 1N3957GP

MINIATURE GLASS PASSIVATED JUNCTION PLASTIC RECTIFIER

Voltage - 200 to 1000 Volts Current - 1.0 Ampere

FEATURES

PATENTED*

DO-41

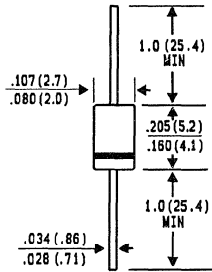

Dimensions in inches and (millimeters)

* Glass-plastic encapsulation technique is covered by Patent No. 3,996,602 of 1976; brazed-lead assembly to Patent No. 3,930,306 of 1976 and glass composition by Patent No. 3,752,701 of 1973



- ◆ High temperature metallurgically bonded constructed rectifiers
- ◆ Plastic package has Underwriters Laboratory Flammability Classification 94V-0
- ◆ Glass passivated cavity-free junction in DO-41 package
- ◆ 1.0 Ampere operation at $T_A = 75^\circ\text{C}$ with no thermal runaway
- ◆ Typical I_R less than $0.1 \mu\text{A}$
- ◆ Capable of meeting environmental standards of MIL-S-19500
- ◆ High temperature soldering guaranteed: $350^\circ\text{C}/10$ seconds/.375", (9.5mm) lead length at 5 lbs., (2.3kg) tension

MECHANICAL DATA

- Case:** Molded plastic over glass
Terminals: Axial leads, solderable per MIL-STD-202, Method 208
Polarity: Color band denotes cathode
Mounting Position: Any
Weight: 0.012 ounce, .3 gram

MAXIMUM RATINGS AND ELECTRICAL CHARACTERISTICS

Ratings at 25°C ambient temperature unless otherwise specified. Resistive or inductive load. For capacitive load, derate current by 20%.

	SYMBOLS	1N 3611GP	1N 3612GP	1N 3613GP	1N 3614GP	1N 3957GP	UNITS
Maximum Recurrent Peak Reverse Voltage	V_{RRM}	200	400	600	800	1000	Volts
Maximum RMS Voltage	V_{RMS}	140	280	420	560	700	Volts
Maximum DC Blocking Voltage	V_{DC}	200	400	600	800	1000	Volts
*Maximum Average Forward Rectified Current .375", (9.5mm) Lead Lengths at $T_A = 75^\circ\text{C}$	$I_{(AV)}$	1.0					Amps
Peak Forward Surge Current 8.3ms single half sine-wave superimposed on rated load (JEDEC Method)	I_{FSM}	30.0					Amps
Maximum Instantaneous Forward Voltage at 1.0A	V_F	1.0					Volts
*Maximum DC Reverse Current $T_A = 25^\circ\text{C}$ at Rated DC Blocking Voltage $T_A = 150^\circ\text{C}$	I_R	300.0					μA
Typical Reverse Recovery Time (Note 1)	T_{RR}	2.0					μs
Typical Junction Capacitance (Note 2)	C_J	10.0					pf
Typical Thermal Resistance (Note 3)	$R_{\theta JA}$	45.0					$^\circ\text{C}/\text{W}$
Operating and Storage Temperature Range	T_J, T_{STG}	-65 to +175					$^\circ\text{C}$

NOTES:

1. Reverse Recovery Test Conditions : $I_F = 0.5\text{A}$, $I_R = 1.0\text{A}$, $I_{rr} = 25\text{A}$.
 2. Measured at 1.0 MHz and applied reverse voltage of $4.0 V_{GR}$.
 3. Thermal Resistance from Junction to Ambient at .375" (9.5mm) Lead Lengths, P.C. Board Mounted.
- * JEDEC Registered Values

**RATINGS AND CHARACTERISTIC CURVES
1N3611GP THRU 1N3614GP AND 1N3957GP**

FIG. 1 — FORWARD CURRENT DERATING CURVE

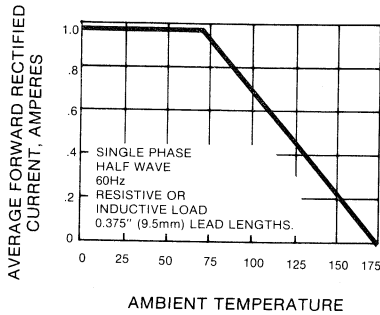

FIG. 2 — TYPICAL INSTANTANEOUS FORWARD CHARACTERISTICS

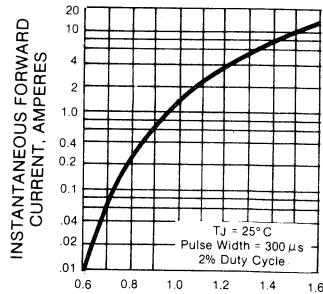

FIG. 3 — MAXIMUM NON-REPETITIVE PEAK FORWARD SURGE CURRENT

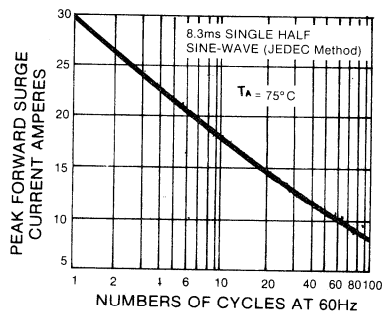

FIG. 4 — TYPICAL JUNCTION CAPACITANCE

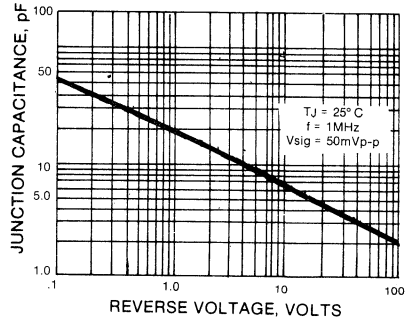

FIG. 5 — TYPICAL REVERSE CHARACTERISTICS

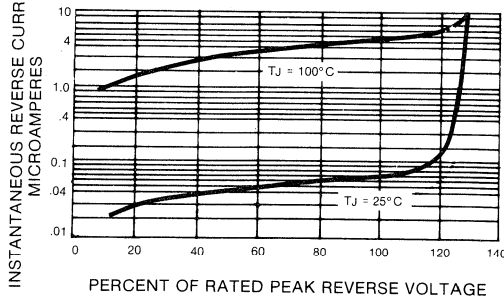
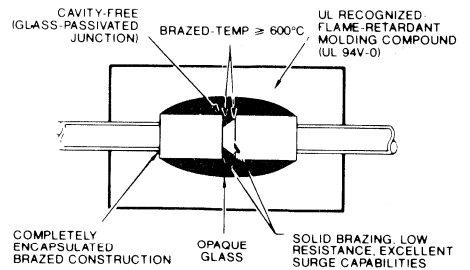

FIG. 6 — GI SUPERRECTIFIER



1N4001GP THRU 1N4007GP

MINIATURE GLASS PASSIVATED JUNCTION PLASTIC RECTIFIER

Voltage - 50 to 1000 Volts Current - 1.0 Ampere

FEATURES

PATENTED*

DO-41

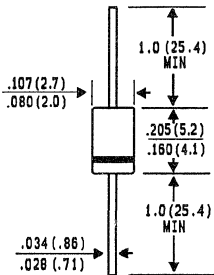

Dimensions in inches and (millimeters)

* Glass-plastic encapsulation technique is covered by Patent No. 3,996,602 of 1976; brazed -lead assembly to Patent No. 3,930,306 of 1976 and glass composition by Patent No. 3,752,701 of 1973



- ◆ High temperature metallurgically bonded constructed rectifiers
- ◆ Plastic package has Underwriters Laboratory Flammability Classification 94V-0
- ◆ Glass passivated cavity-free junction in DO-41 package
- ◆ 1.0 Ampere operation at $T_A = 75^\circ\text{C}$ with no thermal runaway
- ◆ Typical I_R less than $0.1 \mu\text{A}$
- ◆ Capable of meeting environmental standards of MIL-S-19500
- ◆ High temperature soldering guaranteed: $350^\circ\text{C}/10$ seconds/.375", (9.5mm) lead length at 5 lbs., (2.3kg) tension

MECHANICAL DATA

Case: Molded plastic over glass

Terminals: Axial leads, solderable per MIL-STD-202, Method 208

Polarity: Color band denotes cathode

Mounting Position: Any

Weight: 0.012 ounce, 0.3 gram

MAXIMUM RATINGS AND ELECTRICAL CHARACTERISTICS

Ratings at 25°C ambient temperature unless otherwise specified. Resistive or inductive load. For capacitive load, derate current by 20%.

	SYMBOLS	1N	1N	1N	1N	1N	1N	UNITS	
		4001GP	4002GP	4003GP	4004GP	4005GP	4006GP		4007GP
*Maximum Recurrent Peak Reverse Voltage	V_{RRM}	50	100	200	400	600	800	1000	Volts
*Maximum RMS Voltage	V_{RMS}	35	70	140	280	420	560	700	Volts
Maximum DC Blocking Voltage	V_{DC}	50	100	200	400	600	800	1000	Volts
*Maximum Average Forward Rectified Current .375", (9.5mm) Lead Lengths at $T_A = 75^\circ\text{C}$	$I_{(AV)}$	1.0							Amps
*Peak Forward Surge Current 8.3ms single half sine-wave superimposed on rated load (JEDEC Method)	I_{FSM}	30.0							Amps
Maximum Instantaneous Forward Voltage at 1.0A	V_F	1.1							Volts
*Maximum Full Load Reverse Current, Full Cycle Average .375", (9.5mm) Lead Length $T_A = 75^\circ\text{C}$	$I_{R(AV)}$	30.0							μA
*Maximum DC Reverse Current $T_A = 25^\circ\text{C}$ at Rated DC Blocking Voltage $T_A = 125^\circ\text{C}$	I_R	5.0							μA
Typical Reverse Recovery Time (Note 1)	T_{RR}	2.0							μs
Typical Junction Capacitance (Note 2)	C_J	8.0							pf
Typical Thermal Resistance (Note 3)	$R_{\theta JA}$	45.0							$^\circ\text{C/W}$
Operating and Storage Temperature Range	T_J, T_{STG}	-65 to +175							$^\circ\text{C}$

NOTES: 1. Reverse Recovery Test Conditions: $I_F = 0.5\text{A}$, $I_R = 1.0\text{A}$, $I_{rr} 0.25\text{A}$.
2. Measured at 1.0 MHz and applied reverse voltage of 4.0 V_{DC}.
3. Thermal Resistance from Junction to Ambient at .375" (9.5mm) Lead Lengths, P.C. Board Mounted.
* JEDEC Registered Values

RATINGS AND CHARACTERISTIC CURVES 1N4001GP THRU 1N4007GP

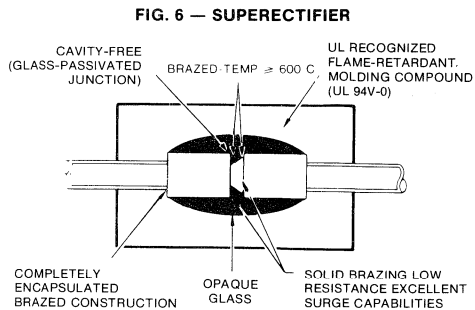
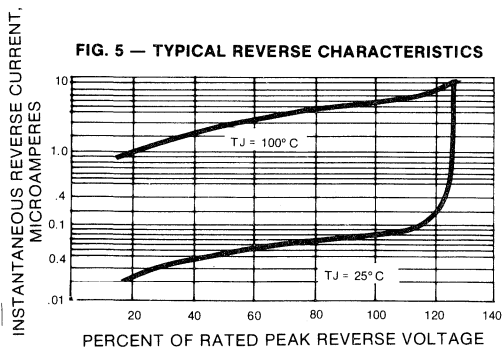
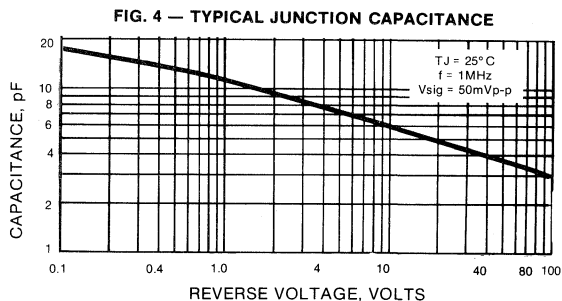
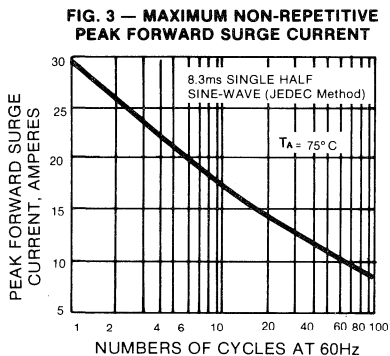
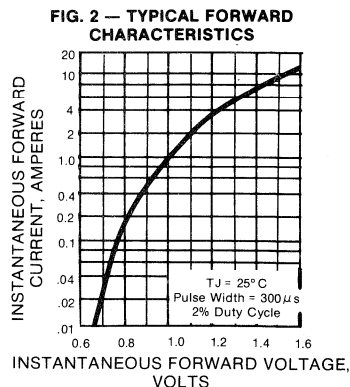
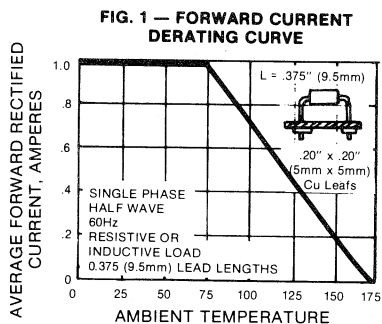

1N4245GP THRU 1N4249GP

MINIATURE GLASS PASSIVATED JUNCTION PLASTIC RECTIFIER

Voltage - 200 to 1000 Volts Current - 1.0 Ampere

FEATURES

PATENTED*

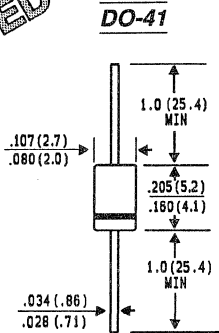

- ◆ High temperature metallurgically bonded constructed rectifiers
- ◆ Plastic package has Underwriters Laboratory Flammability Classification 94V-0
- ◆ Glass passivated cavity-free junction version of 1N4249 in DO-41 package
- ◆ 1.0 Ampere operation at $T_A = 55^\circ\text{C}$ with no thermal runaway
- ◆ Capable of meeting environmental standards of MIL-S-19500
- ◆ High temperature soldering guaranteed $350^\circ\text{C}/10$ seconds/.375", (9.5mm) lead length at 5 lbs., (2.3kg) tension

Dimensions in inches and (millimeters)

MECHANICAL DATA

* Glass-plastic encapsulation technique is covered by Patent No. 3,996,602 of 1976; brazed-lead assembly to Patent No. 3,930,306 of 1976 and glass composition by Patent No. 3,752,701 of 1973

Case: Molded plastic over glass

Terminals: Plated Axial leads, solderable per MIL-STD-202, Method 208

Polarity: Color band denotes cathode

Mounting Position: Any

Weight: 0.012 ounce, .3 gram



MAXIMUM RATINGS AND ELECTRICAL CHARACTERISTICS

Ratings at 25°C ambient temperature unless otherwise specified. 60 Hz Resistive or inductive load. For capacitive load, derate current by 20%.

	SYMBOLS	1N 4245GP	1N 4246GP	1N 4247GP	1N 4248GP	1N 4249GP	UNITS
* Maximum Recurrent Peak Reverse Voltage	V_{RRM}	200	400	600	800	1000	Volts
* Maximum RMS Voltage	V_{RMS}	140	280	420	560	700	Volts
* Maximum DC Blocking Voltage	V_{DC}	200	400	600	800	1000	Volts
* Maximum Average Forward Rectified Current .375", (9.5mm) Lead Lengths at $T_A = 55^\circ\text{C}$	$I_{(AV)}$	1.0					Amps
* Peak Forward Surge Current 8.3ms single half sine-wave superimposed on rated load (JEDEC Method)	I_{FSM}	25.0					Amps
* Maximum Instantaneous Forward Voltage at 1.0A	V_F	1.2					Volts
* Maximum Full Load Reverse Current Full Cycle Average .375" (9.5mm) Lead Length $T_A = 55^\circ\text{C}$	$I_{R(AV)}$	50.0					μA
* Maximum Reverse Current at Rated DC Blocking Voltage $T_A = 25^\circ\text{C}$ $T_A = 25^\circ\text{C}$	I_R	1.0 25.0					μA
Typical Junction Capacitance (Note 1)	C_J	8.0					pf
Typical Thermal Resistance (Note 2)	$R_{\theta JA}$	45.0					$^\circ\text{C}/\text{W}$
* Operating Temperature Range	T_J	-65 to +160					$^\circ\text{C}$
* Storage Temperature Range	T_{STG}	-65 to +175					$^\circ\text{C}$

NOTES:

1. Measured at 1.0 MHz and applied reverse voltage of 4.0 Volts.
 2. Thermal Resistance from Junction to Ambient at .375" (9.5mm) Lead Lengths, P.C. Board Mounted.
- * JEDEC registered values

RATINGS AND CHARACTERISTIC CURVES 1N4245GP THRU 1N4249GP

FIG. 1 — FORWARD CURRENT DERATING CURVE

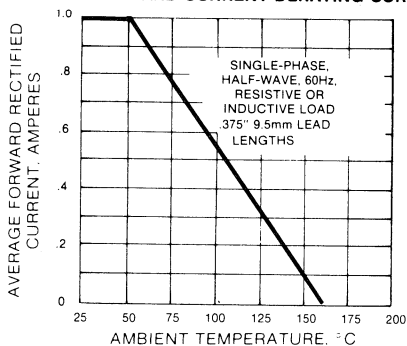

FIG. 2 — TYPICAL INSTANTANEOUS FORWARD CHARACTERISTICS

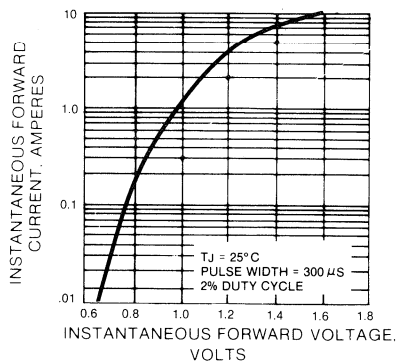

FIG. 3 — MAXIMUM NON-REPETITIVE PEAK FORWARD SURGE CURRENT

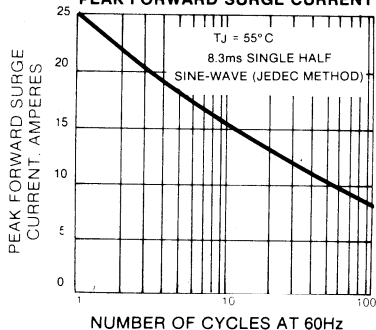

FIG. 4 — TYPICAL JUNCTION CAPACITANCE

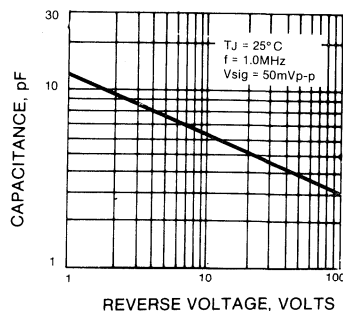

FIG. 5 — TYPICAL REVERSE CHARACTERISTICS

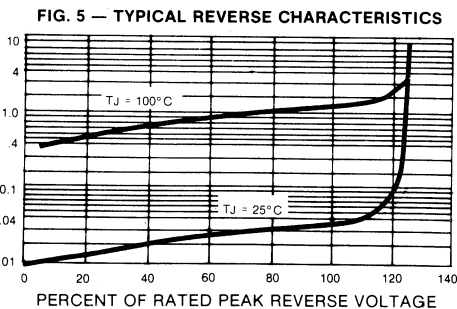
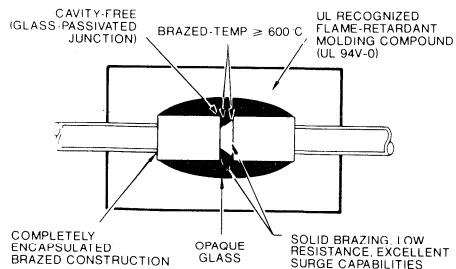

FIG. 6 — SUPERRECTIFIER



GP10A THRU GP10Y

MINIATURE GLASS PASSIVATED JUNCTION PLASTIC RECTIFIER

Voltage - 50 to 1600 Volts Current - 1.0 Ampere

FEATURES

PATENTED*

DO-41

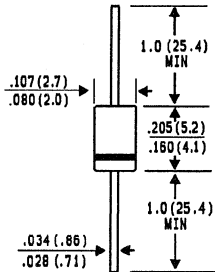

Dimensions in inches and (millimeters)

* Glass-plastic encapsulation technique is covered by Patent No. 3,996,602 of 1976; brazed-lead assembly to Patent No. 3,930,306 of 1976 and glass composition by Patent No. 3,752,701 of 1973



- ◆ High temperature metallurgically bonded constructed rectifiers
- ◆ Plastic package has Underwriters Laboratory Flammability Classification 94V-0
- ◆ Glass passivated cavity-free junction in DO-41 package
- ◆ 1.0 Ampere operation at $T_A = 55^\circ\text{C}$ with no thermal runaway
- ◆ Typical I_R less than $0.1 \mu\text{A}$
- ◆ Capable of meeting environmental standards of MIL-S-19500
- ◆ High temperature soldering guaranteed $350^\circ\text{C}/10$ seconds/.375", (9.5mm) lead length at 5 lbs., (2.3kg) tension



MECHANICAL DATA

Case: Molded plastic over glass
Terminals: Plated Axial leads, solderable per MIL-STD-202, Method 208
Polarity: Color band denotes cathode
Mounting Position: Any
Weight: 0.012 ounce, .3 gram

MAXIMUM RATINGS AND ELECTRICAL CHARACTERISTICS

Ratings at 25°C ambient temperature unless otherwise specified.
 Single phase, half wave 60HZ, resistive or inductive load.
 For capacitive load, derate current by 20%.

	SYMBOLS	A	B	D	G	J	K	M	N	Q	T	V	W	Y	UNITS
Maximum Recurrent Peak Reverse Voltage	V_{RRM}	50 to 1600 Volts, See Fig 5.													Volts
Maximum Average Forward Rectified Current .375", (9.5mm) Lead Lengths at $T_A = 55^\circ\text{C}$	$I_{(AV)}$	1.0													Amps
Peak Forward Surge Current 8.3ms single half sine-wave superimposed on rated load (JEDEC Method)	I_{FSM}	30.0						25.0						Amps	
Maximum Instantaneous Forward Voltage at 1.0A	V_F	1.1			1.2			1.3						Volts	
Maximum Full Load Reverse Current, Full Cycle Average, .375", (9.5mm) Lead Lengths at $T_A = 75^\circ\text{C}$	$I_{R(AV)}$	30.0													μA
Maximum DC Reverse Current $T_A = 25^\circ\text{C}$ at Rated DC Blocking Voltage $T_A = 125^\circ\text{C}$	I_R	50.0													μA
Typical Reverse Recovery Time (Note 1)	T_{RR}	2.0													μs
Typical Junction Capacitance (Note 2)	C_J	8.0			7.0			5.0						pf	
Typical Thermal Resistance (Note 3)	$R_{\theta JA}$	45.0													$^\circ\text{C}/\text{W}$
Operating and Storage Temperature Range	T_J, T_{STG}	-65 to +175													$^\circ\text{C}$

NOTES:

1. Reverse Recovery Test Condition: $I_F = 0.5\text{A}$, $I_R = 1.0\text{A}$, $I_{rr} = .25\text{A}$.
2. Measured at 1.0 MHz and applied reverse voltage of 4.0 Volts.
3. Thermal Resistance from Junction to Ambient at .375" (9.5mm) Lead Lengths, P.C. Board Mounted.

RATINGS AND CHARACTERISTIC CURVES GP10A THRU GP10Y

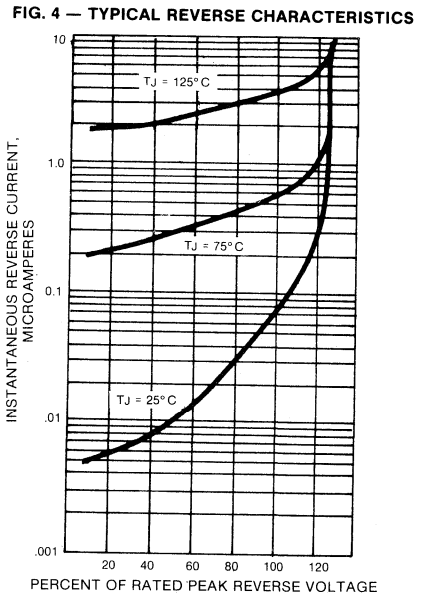
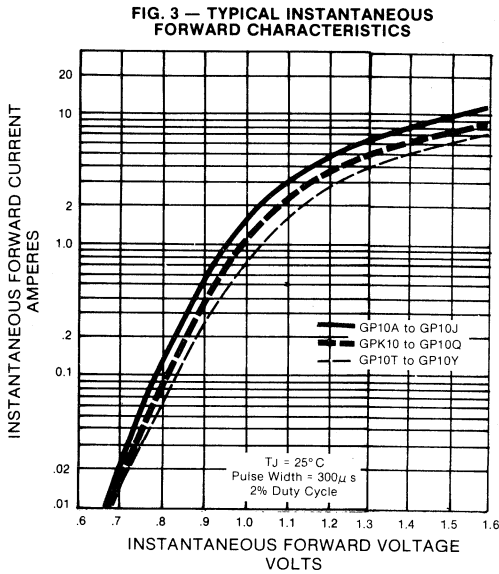
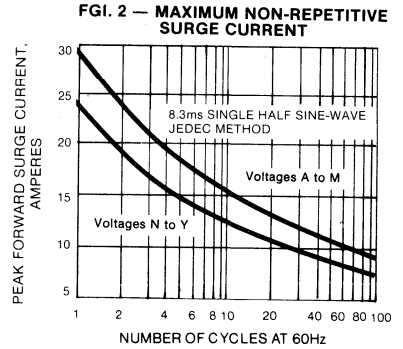
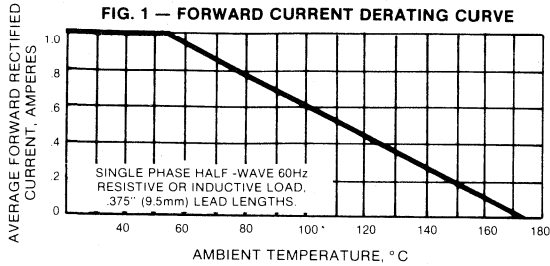
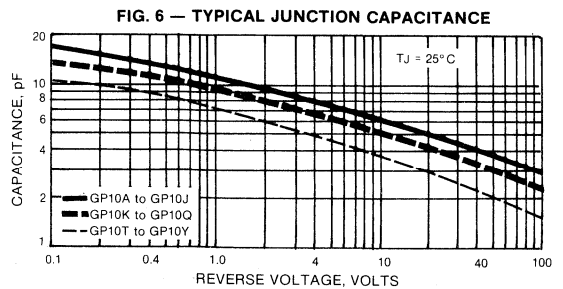

Fig. 5 — MAXIMUM RECURRENT PEAK REVERSE VOLTAGE

GP10A - 50V
GP10B - 100V
GP10D - 200V
GP10G - 400V
GP10J - 600V
GP10K - 800V
GP10M - 1000V
GP10N - 1100V
GP10Q - 1200V
GP10T - 1300V
GP10V - 1400V
GP10W - 1500V
GP10Y - 1600V



BYW27-50GP THRU BYW27-1000GP

GLASS PASSIVATED JUNCTION PLASTIC MINIATURE RECTIFIER

Voltage - 50 to 1000 Volts Current - 1.0 Ampere

FEATURES

PATENTED*

DO-41

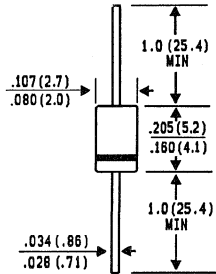

Dimensions in inches and (millimeters)

* Glass-plastic encapsulation technique is covered by Patent No. 3,996,602 of 1976; brazed-lead assembly to Patent No. 3,930,306 of 1976 and glass composition by Patent No. 3,752,701 of 1973



- ◆ High temperature metallurgically bonded constructed rectifiers
- ◆ Plastic package has Underwriters Laboratory Flammability Classification 94V-0
- ◆ Glass passivated cavity-free junction in DO-41 package
- ◆ 1.0 Ampere operation at $T_A = 55^\circ\text{C}$ with no thermal runaway
- ◆ Typical I_R less than $0.1 \mu\text{A}$
- ◆ Capable of meeting environmental standards of MIL-S-19500
- ◆ High temperature soldering guaranteed: $350^\circ\text{C}/10$ seconds/.375", (9.5mm) lead length at 5 lbs., (2.3kg) tension

MECHANICAL DATA

Case: Molded plastic over glass

Terminals: Plated Axial leads, solderable per MIL-STD-202, Method 208

Polarity: Color band denotes cathode

Mounting Position: Any

Weight: 0.012 ounce, 0.3 gram

MAXIMUM RATINGS AND ELECTRICAL CHARACTERISTICS

Ratings at 25°C ambient temperature unless otherwise specified. Single phase, half wave, 60 Hz, resistive or inductive load. For capacitive load, derate current by 20%.

	SYMBOLS	BYW27	BYW27	BYW27	BYW27	BYW27	BYW27	BYW27	UNITS
		50GP	-100GP	-200GP	-400GP	-600GP	-800GP	-1000GP	
Maximum Recurrent Peak Reverse Voltage	V_{RRM}	50	100	200	400	600	800	1000	Volts
Maximum RMS Voltage	V_{RMS}	35	70	140	280	420	560	700	Volts
Maximum DC Blocking Voltage	V_{DC}	50	100	200	400	600	800	1000	Volts
Maximum Average Forward Rectified Current .375", (9.5mm) Lead Lengths at $T_A = 70^\circ\text{C}$	$I_{(AV)}$	1.0							Amps
Peak Forward Surge Current 10ms single half sine-wave no load	I_{FSM}	50.0							Amps
Maximum Instantaneous Forward Voltage at 1.0A	V_F	1.0							Volts
Maximum DC Reverse Current at Rated DC Blocking Voltage $T_A = 25^\circ\text{C}$	I_R	200							nA
Maximum Full Load Reverse Current, Full Cycle Average .375", (9.5mm) Lead Length $T_A = 100^\circ\text{C}$	$I_{R(AV)}$	15.0							μA
Typical Reverse Recovery Time (Note 1)	T_{RR}	20.0							μs
Typical Junction Capacitance (Note 2)	C_J	8.0							pf
Typical Thermal Resistance (Note 3)	$R_{\theta JA}$	45.0							$^\circ\text{C}/\text{W}$
Operating and Storage Temperature Range	T_J, T_{STG}	-65 to +150							$^\circ\text{C}$

- NOTES: 1. Measured on Tektronix Type S recovery plug-in. Tektronix 545 Scope (or equiv.) . $I_{FM} = 20\text{mA}$, $I_{RM} = 1.0\text{mA}$.
2. Measured at 1.0 MHz and applied reverse voltage of 4.0 Volts.
3. Thermal Resistance from Junction to Ambient at .375" (9.5mm) Lead Lengths, P.C. Board Mounted.

RATINGS AND CHARACTERISTIC CURVES BYW27-50GP THRU BYW27-1000GP

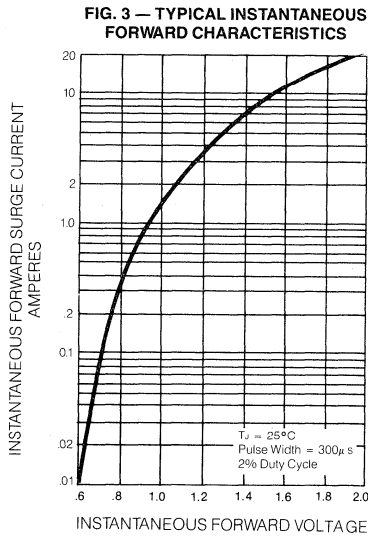
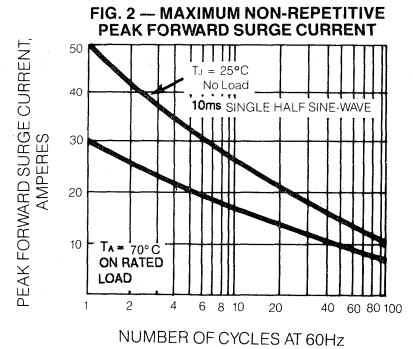
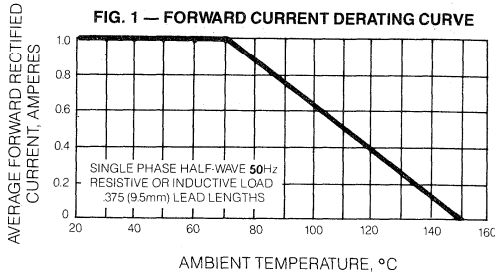

FIG. 4 — TYPICAL REVERSE CHARACTERISTICS

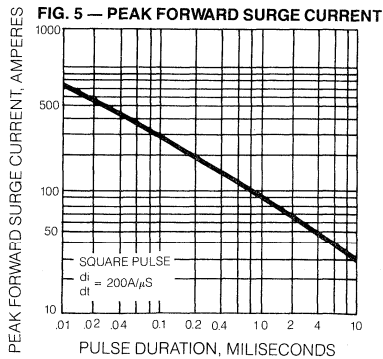
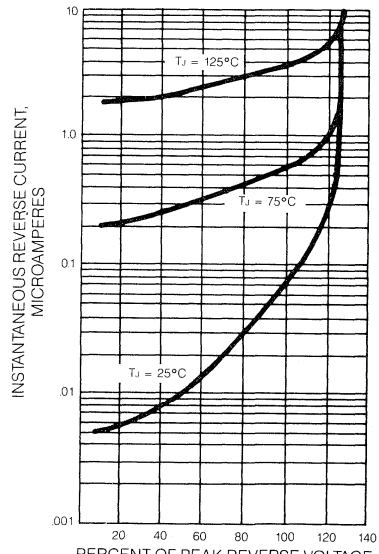
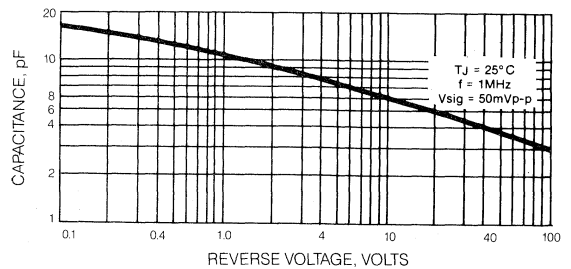

FIG. 6 — TYPICAL JUNCTION CAPACITANCE



1N4383GP THRU 1N4385GP 1N4585GP AND 1N4586GP

MINIATURE GLASS PASSIVATED JUNCTION PLASTIC RECTIFIER

Voltage - 200 to 1000 Volts Current - 1.0 Ampere

FEATURES

PATENTED*

DO-15

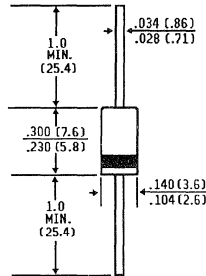

- ◆ High temperature metallurgically bonded constructed rectifiers
- ◆ Plastic package has Underwriters Laboratory Flammability Classification 94V-0
- ◆ Glass passivated cavity-free junction in DO-15 package
- ◆ 1.0 Ampere operation at $T_A = 100^\circ\text{C}$ with no thermal runaway
- ◆ Capable of meeting environmental standards of MIL-S-19500
- ◆ High temperature soldering guaranteed: $350^\circ\text{C}/10$ seconds/.375", (9.5mm) lead length at 5 lbs., (2.3kg) tension

Dimensions in inches and (millimeters)

* Glass-plastic encapsulation technique is covered by Patent No. 3,996,602 of 1976; brazed-lead assembly to Patent No. 3,930,306 of 1976 and glass composition by Patent No. 3,752,701 of 1973

MECHANICAL DATA

- Case:** Molded plastic over glass
Terminals: Plated Axial leads, solderable per MIL-STD-202, Method 208
Polarity: Color band denotes cathode
Mounting Position: Any
Weight: 0.015 ounce, 0.4 gram

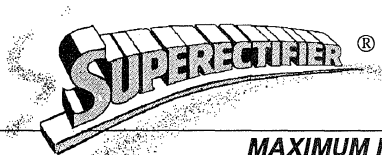

MAXIMUM RATINGS AND ELECTRICAL CHARACTERISTICS

Ratings at 25°C ambient temperature unless otherwise specified. Single half wave, 60 Hz, resistive or inductive load. For capacitive load, derate current by 20%.

	SYMBOLS	1N 4383GP	1N 4384GP	1N 4385GP	1N 4585GP	1N 4586GP	UNITS
* Maximum Recurrent Peak Reverse Voltage	V_{RRM}	200	400	600	800	1000	Volts
* Maximum RMS Voltage	V_{RMS}	140	280	420	560	700	Volts
* Maximum DC Blocking Voltage	V_{DC}	200	400	600	800	1000	Volts
* Maximum Average Forward Rectified Current .375", (9.5mm) Lead Lengths	$I_{(AV)}$	1.0					Amps
* Peak Forward Surge Current 8.3ms single half sine-wave superimposed on rated load (JEDEC Method) at $T_A = 100^\circ\text{C}$	I_{FSM}	50.0					Amps
Maximum Instantaneous Forward Voltage at 1.0A	V_F	1.0					Volts
Maximum DC Reverse Current $T_A = 25^\circ\text{C}$ at Rated DC Blocking Voltage $T_A = 150^\circ\text{C}$	I_R	5.0					μA
* Typical Reverse Recovery Time (Note 2)	T_{RR}	2.0					μs
Maximum Full Load Reverse Current Full Cycle Average at .375"(9.5mm) Lead Lengths, $T_A = 100^\circ\text{C}$	$I_{R(AV)}$	275	250	225	200	200	μA
Typical Junction Capacitance (Note 1)	C_J	15.0					pf
Typical Thermal Resistance (Note 3)	$R_{\theta JA}$	25.0					$^\circ\text{C/W}$
* Operating and Storage Temperature Range	T_J, T_{STG}	-65 to +175					$^\circ\text{C}$

- NOTES: 1. Measured at 1.0 MHz and applied reverse voltage of 4.0 Volts.
 2. Reverse Recovery Test Conditions: $I_F = 0.5\text{A}$, $I_R = 1.0\text{A}$, $I_{rr} = 0.25\text{A}$.
 3. Thermal Resistance from Junction to Ambient at .375" (9.5mm) Lead Lengths, P.C. Board Mounted.
 * JEDEC registered values

**RATINGS AND CHARACTERISTIC CURVES 1N4383GP THRU 1N4385GP
1N4585GP AND 1N4586GP**

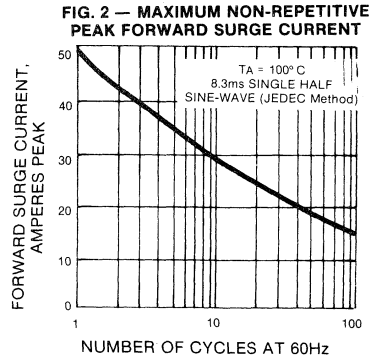
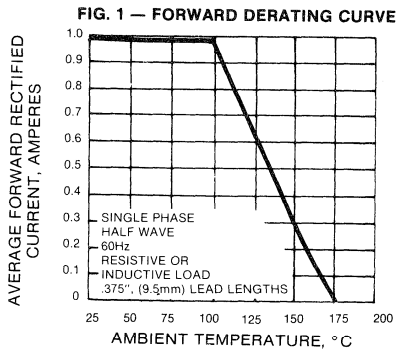

FIG. 3 — TYPICAL FORWARD CHARACTERISTICS

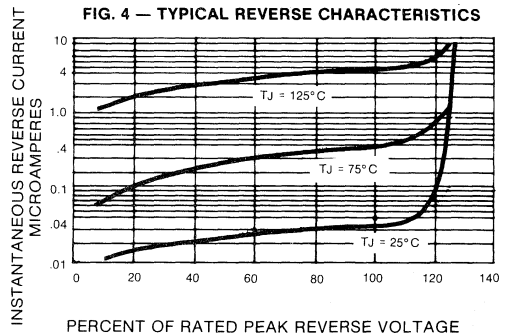
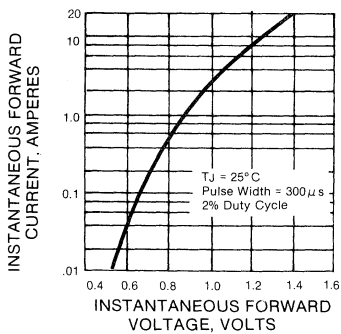

FIG. 5 — TYPICAL JUNCTION CAPACITANCE

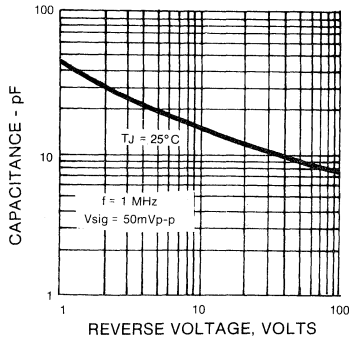
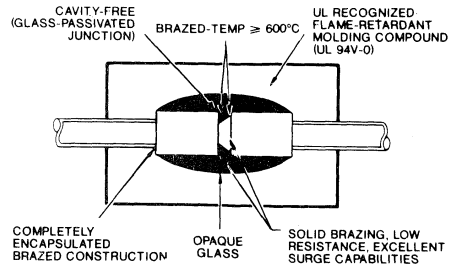

FIG. 6 — SUPERRECTIFIER



1N5059GP THRU 1N5062GP

MINIATURE GLASS PASSIVATED JUNCTION PLASTIC RECTIFIER

Voltage - 200 to 800 Volts Current - 1.0 Ampere

FEATURES

PATENTED*

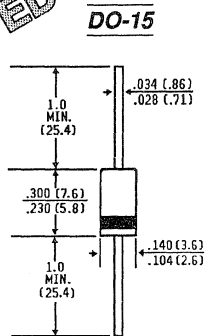

Dimensions in inches and (millimeters)

- ◆ High temperature metallurgically bonded constructed rectifiers
- ◆ Plastic package has Underwriters Laboratory Flammability Classification 94V-0
- ◆ Glass passivated cavity-free junction version of 1N5059 thru 1N5062 in DO-15 package
- ◆ 1.0 Ampere operation at $T_A = 75^\circ\text{C}$ with no thermal runaway
- ◆ Typical I_R less than $0.1 \mu\text{A}$
- ◆ Capable of meeting environmental standards of MIL-S-19500
- ◆ High temperature soldering guaranteed: $350^\circ\text{C}/10$ seconds/.375", (9.5mm) lead length at 5 lbs., (2.3kg) tension

MECHANICAL DATA

Case: Molded plastic over glass
Terminals: Plated Axial leads, solderable per MIL-STD-202, Method 208
Polarity: Color band denotes cathode
Mounting Position: Any
Weight: 0.015 ounce, 0.4 gram

* Glass-plastic encapsulation technique is covered by Patent No. 3,996,602 of 1976; brazed-lead assembly to Patent No. 3,930,306 of 1976 and glass composition by Patent No. 3,752,701 of 1973



MAXIMUM RATINGS AND ELECTRICAL CHARACTERISTICS

Ratings at 25°C ambient temperature unless otherwise specified. 60Hz Resistive or inductive load. For capacitive load, derate current by 20%.

	SYMBOLS	1N5059GP	1N5060GP	1N5061GP	1N5062GP	UNITS
*Maximum Recurrent Peak Reverse Voltage	V_{RRM}	200	400	600	800	Volts
Maximum RMS Voltage	V_{RMS}	140	280	420	560	Volts
*Maximum DC Blocking Voltage	V_{DC}	200	400	600	800	Volts
*Maximum Average Forward Rectified Current .375", (9.5mm) Lead Lengths at $T_A = 75^\circ\text{C}$	$I_{(AV)}$	1.0				Amps
*Peak Forward Surge Current 8.3ms single half sine-wave superimposed on rated load (JEDEC Method)	I_{FSM}	50.0				Amps
*Maximum Instantaneous Forward Voltage at 1.0A $T_A = 75^\circ\text{C}$	V_F	1.2				Volts
*Maximum Full Load Reverse Current, Full Cycle Average, .375" (9.5mm) Lead Lengths at $T_A = 25^\circ\text{C}$ $T_A = 75^\circ\text{C}$	$I_{R(AV)}$	5.0 150.0				μA
*Maximum DC Reverse Current at Rated DC Blocking Voltage $T_A = 25^\circ\text{C}$ $T_A = 175^\circ\text{C}$	I_R	5.0 300.0				μA
Typical Reverse Recovery Time (Note 1)	T_{RR}	2.0				μs
Typical Junction Capacitance (Note 2)	C_J	15.0				pf
Typical Thermal Resistance (Note 3)	$R_{\theta JA}$	25.0				$^\circ\text{C}/\text{W}$
*Operating and Storage Temperature Range	T_J, T_{STG}	-65 to +175				$^\circ\text{C}$

NOTES:

1. Reverse Recovery Test Conditions : $I_F = 0.5\text{A}$, $I_R = 1.0\text{A}$, recover to 0.25A.
2. Measured at 1.0 MHz and applied reverse voltage of 4.0 V_{DC} .
3. Thermal Resistance from Junction to Ambient at .375" (9.5mm) Lead Lengths, P.C. Board Mounted.
* JEDEC Registered Value

RATINGS AND CHARACTERISTIC CURVES 1N5059GP THRU 1N5062GP

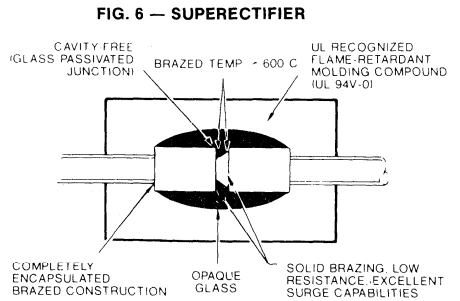
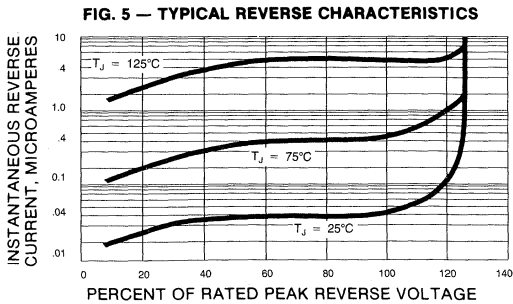
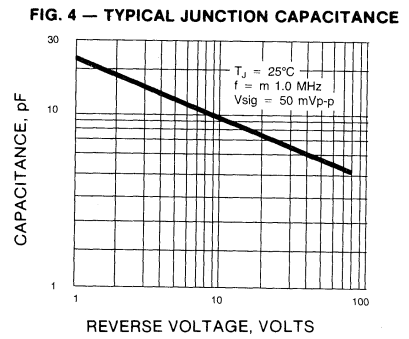
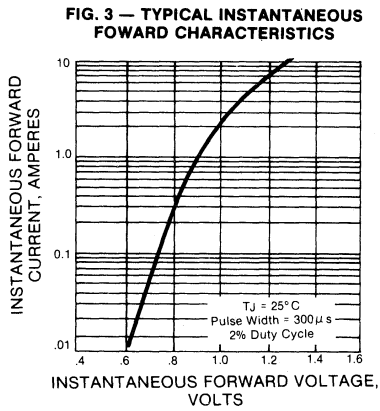
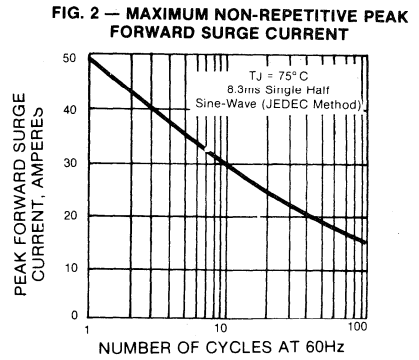
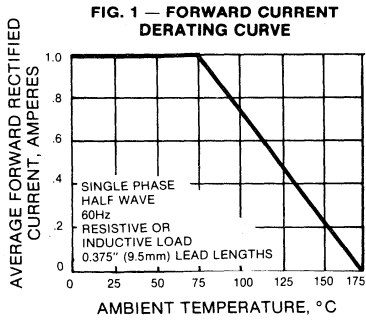

BY133GP THRU BY135GP

MINIATURE GLASS PASSIVATED JUNCTION PLASTIC RECTIFIER

Voltage - 200 to 1300 Volts Current - 1.0 Ampere

FEATURES

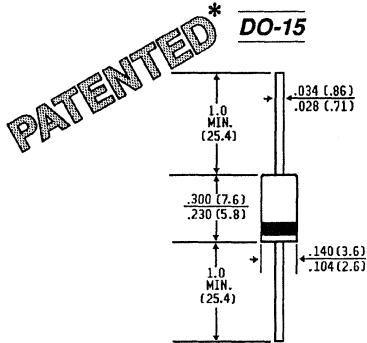

Dimensions in inches and (millimeters)

* Glass-plastic encapsulation technique is covered by Patent No. 3,996,602 of 1976; brazed -lead assembly to Patent No. 3,930,306 of 1976 and glass composition by Patent No. 3,752,701 of 1973



- ◆ High temperature metallurgically bonded constructed rectifiers
- ◆ Plastic package has Underwriters Laboratory Flammability Classification 94V-0
- ◆ Glass passivated cavity-free junction in DO-15 package
- ◆ 1.0 Ampere operation at $T_A = 75^\circ\text{C}$ with no thermal runaway
- ◆ Typical I_R less than $0.1 \mu\text{A}$
- ◆ Capable of meeting environmental standards of MIL-S-19500
- ◆ High temperature soldering guaranteed: $350^\circ\text{C}/10$ seconds/.375", (9.5mm) lead length at 5 lbs., (2.3kg) tension

MECHANICAL DATA

Case: Molded plastic over glass
Terminals: Plated Axial leads, solderable per MIL-STD-202, Method 208
Polarity: Color band denotes cathode
Mounting Position: Any **Weight:** 0.015 ounce, 0.4 gram

MAXIMUM RATINGS AND ELECTRICAL CHARACTERISTICS

Ratings at 25°C ambient temperature unless otherwise specified. Single phase, half wave 60 HZ, resistive or inductive load For capacitive load, derate current by 20%.

	SYMBOLS	BY133GP	BY134GP	BY135GP	UNITS
Maximum Non-Recurrent Peak Reverse Voltage	V_{RSM}	1600	800	200	Volts
Maximum Recurrent Peak Reverse Voltage	V_{RRM}	1300	600	200	Volts
Maximum RMS Voltage	V_{RMS}	910	420	140	Volts
Maximum DC Blocking Voltage at $T_A = 150^\circ\text{C}$	V_{DC}	1300	600	200	Volts
*Maximum Average Forward Rectified Current 375", (9.5mm) Lead Lengths at $T_A = 75^\circ\text{C}$	$I_{(AV)}$		1.0		Amps
Peak Forward Surge Current 10 ms single half sine-wave superimposed on rated load $T_A = 25^\circ\text{C}$	I_{FSM}		50.0		Amps
Maximum Instantaneous Forward Voltage at 2.0A $T_A = 75^\circ\text{C}$	V_F		1.2		Volts
Maximum DC Reverse Current $T_A = 25^\circ\text{C}$ at Rated DC Blocking Voltage $T_A = 175^\circ\text{C}$	I_R		5.0 200		μA
Maximum Full Load Reverse Current Full Cycle Average, .375", (9.5 mm) Leads Length at $T_A = 25^\circ\text{C}$ $T_A = 75^\circ\text{C}$	$I_{R(AV)}$		5.0 200		μA
Typical Junction Capacitance (Note 1)	C_J		15.0		pf
Typical Reverse Recovery Time (Note 2)	T_{RR}		2.0		μs
Typical Thermal Resistance (Note 3)	$R_{\theta JA}$		25.0		$^\circ\text{C}/\text{W}$
Operating and Storage Temperature Range	T_J, T_{STG}		-65 to +175		$^\circ\text{C}$

NOTES:

1. Measured at 1.0 MHz and applied reverse voltage of $4.0 V_{DC}$.
2. Reverse Recovery Test Condition: $I_F = 0.5\text{A}$, $I_R = 1.0\text{A}$, $I_{RR} = 0.25\text{A}$.
3. Thermal Resistance from Junction to Ambient at .375" (9.5mm) Lead Lengths, P.C. Board Mounted.

RATINGS AND CHARACTERISTIC CURVES BY133GP THRU BY135GP

FIG. 1 — FORWARD CURRENT DERATING CURVE

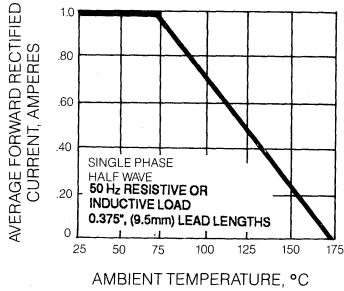

FIG. 2 — MAXIMUM NON-REPETITIVE PEAK FORWARD SURGE CURRENT

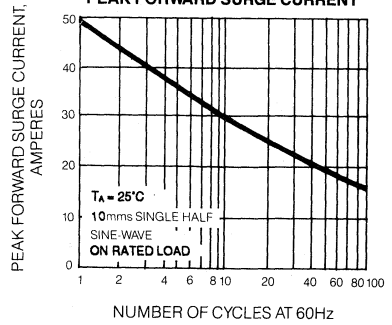

FIG. 3 — TYPICAL INSTANTANEOUS FORWARD CHARACTERISTICS

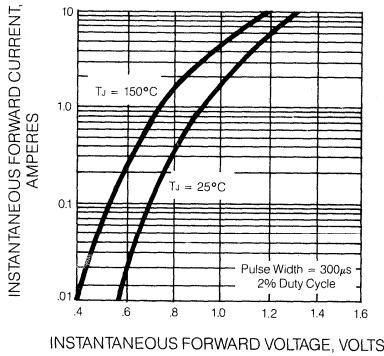

FIG. 4 — TYPICAL JUNCTION CAPACITANCE

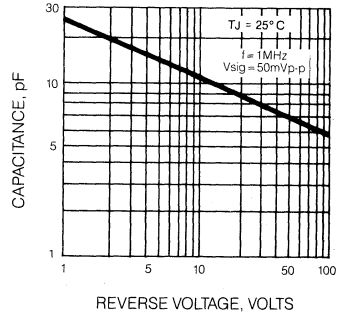

FIG. 5 — TYPICAL REVERSE CHARACTERISTICS

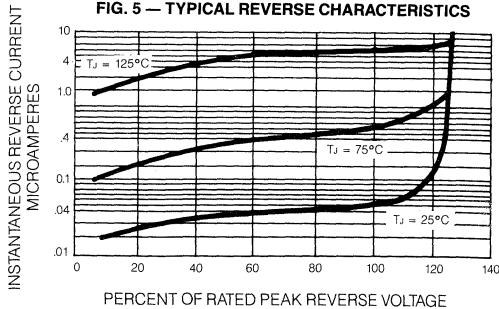
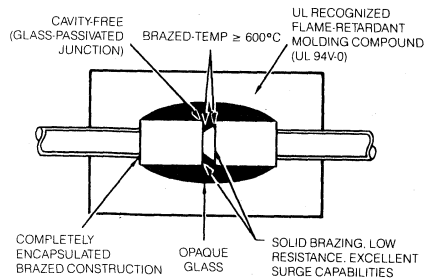

FIG. 6 — SUPERRECTIFIER



1N5391GP THRU 1N5399GP

MINIATURE GLASS PASSIVATED JUNCTION PLASTIC RECTIFIER

Voltage - 50 to 1000 Volts Current - 1.5 Amperes

FEATURES

PATENTED*

DO-15

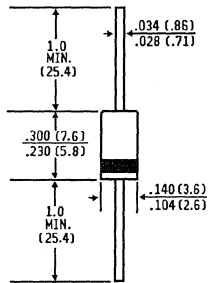

Dimensions in inches and (millimeters)

- ◆ High temperature metallurgically bonded constructed rectifiers
- ◆ Plastic package has Underwriters Laboratory Flammability Classification 94V-0
- ◆ Glass passivated cavity-free junction
- ◆ 1.5 Ampere operation at $T_A = 70^\circ\text{C}$ with no thermal runaway
- ◆ Typical I_R less than $0.1 \mu\text{A}$
- ◆ Capable of meeting environmental standards of MIL-S-19500
- ◆ High temperature soldering guaranteed $350^\circ\text{C}/10$ seconds/.375", (9.5mm) lead length at 5 lbs., (2.3kg) tension

MECHANICAL DATA

Case: Molded plastic over glass

Terminals: Plated Axial leads, solderable per MIL-STD-202, Method 208

Polarity: Color band denotes cathode

Mounting Position: Any

Weight: 0.015 ounce, 0.4 gram

* Glass-plastic encapsulation technique is covered by Patent No. 3,996,602 of 1976; brazed-lead assembly to Patent No. 3,930,306 of 1976 and glass composition by Patent No. 3,752,701 of 1973

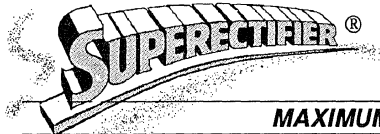

MAXIMUM RATINGS AND ELECTRICAL CHARACTERISTICS

Ratings at 25°C ambient temperature unless otherwise specified. Single phase, half wave 60 Hz, resistive or inductive load. For capacitive load, derate current by 20%.

	SYMBOLS	1N53	1N53	1N53	1N53	1N53	1N53	1N53	1N53	1N53	UNITS
		91GP	92GP	93GP	94GP	95GP	96GP	97GP	98GP	99GP	
* Maximum Recurrent Peak Reverse Voltage	V_{RRM}	50	100	200	300	400	500	600	800	1000	Volts
* Maximum RMS Voltage	V_{RMS}	35	70	140	210	280	350	420	560	700	Volts
* Maximum DC Blocking Voltage	V_{DC}	50	100	200	300	400	500	600	800	1000	Volts
* Maximum Average Forward Rectified Current .375", (9.5mm) Lead Lengths at $T_A = 70^\circ\text{C}$	$I_{(AV)}$	1.5									Amps
* Peak Forward Surge Current 8.3ms single half sine-wave superimposed on rated load (JEDEC Method)	I_{FSM}	50.0									Amps
Maximum Instantaneous Forward Voltage at 1.5A, $T_A = 70^\circ\text{C}$	V_F	1.4									Volts
Maximum DC Reverse Current $T_A = 25^\circ\text{C}$ at Rated DC Blocking Voltage $T_A = 100^\circ\text{C}$	I_R	300.0									μA
* Maximum Full Load Reverse Current Full Cycle Average, .375", (9.5mm) Lead Length at $T_A = 70^\circ\text{C}$	$I_{R(AV)}$	300.0									μA
Typical Reverse Recovery Time (Note 2)	T_{RR}	2.0									μs
Typical Junction Capacitance (Note 1)	C_J	15.0									pf
Typical Thermal Resistance (Note 3)	$R_{\theta JA}$	30.0									$^\circ\text{C/W}$
* Operating and Storage Temperature Range	T_J, T_{STG}	-65 to +175									$^\circ\text{C}$

NOTES:1. Measured at 1.0 MHz and applied reverse voltage of 4.0 VDC.

2. Reverse Recovery Test Condition: $I_F = 0.5\text{A}$, $I_R = 1.0\text{A}$, $I_{rr} = 0.25\text{A}$.

3. Thermal Resistance from Junction to Ambient at .375" (9.5mm) Lead Lengths, P.C. Board Mounted.

* JEDEC registered values

RATINGS AND CHARACTERISTIC CURVES SERIES 1N5391GP THRU 1N5399GP

FIG. 1 — FORWARD CURRENT DERATING CURVE

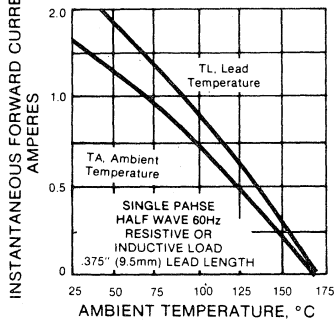

FIG. 2 — TYPICAL FORWARD CHARACTERISTICS

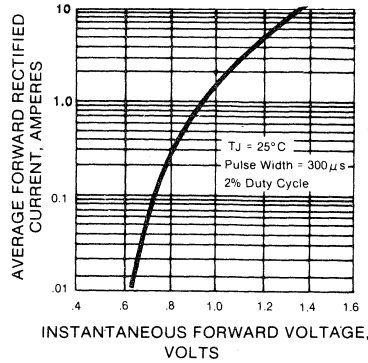

FIG. 3 — PEAK FORWARD SURGE CURRENT

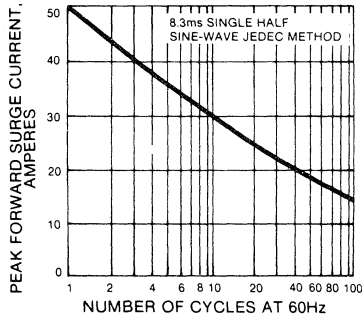

FIG. 4 — TYPICAL JUNCTION CAPACITANCE

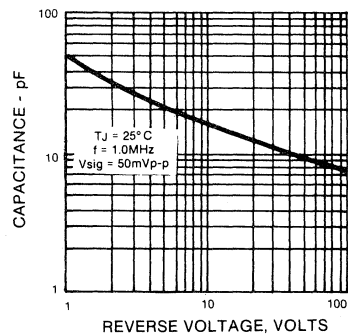

FIG. 5 — TYPICAL REVERSE CHARACTERISTICS

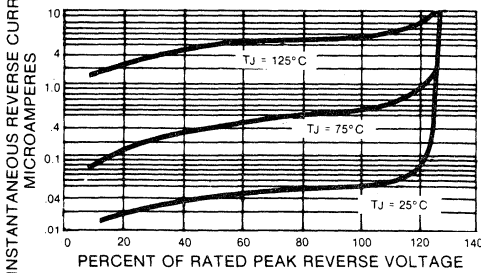
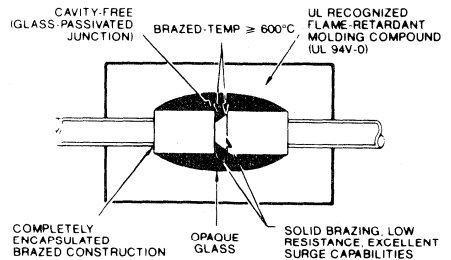

FIG. 6 - SUPERRECTIFIER



GP15A THRU GP15M

MINIATURE GLASS PASSIVATED JUNCTION PLASTIC RECTIFIER

Voltage - 50 to 1000 Volts Current - 1.5 Amperes

FEATURES

PATENTED*

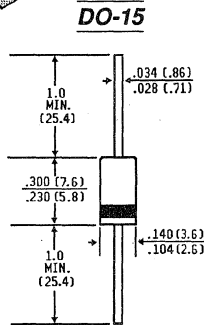

Dimensions in inches and (millimeters)

- ◆ High temperature metallurgically bonded constructed rectifiers
- ◆ Plastic package has Underwriters Laboratory Flammability Classification 94V-0
- ◆ Glass passivated cavity-free junction in D0-15 package
- ◆ 1.5 Ampere operation at $T_A = 55^\circ\text{C}$ with no thermal runaway
- ◆ Typical I_R less than $0.1 \mu\text{A}$
- ◆ Capable of meeting environmental standards of MIL-S-19500
- ◆ High temperature soldering guaranteed $350^\circ\text{C}/10$ seconds/.375", (9.5mm) lead length at 5 lbs., (2.3kg) tension

MECHANICAL DATA

* Glass-plastic encapsulation technique is covered by Patent No. 3,996,602 of 1976; brazed-lead assembly to Patent No. 3,930,306 of 1976 and glass composition by Patent No. 3,752,701 of 1973

- Case:** Moulded plastic over glass
Terminals: Plated Axial leads, solderable per MIL-STD-202, Method 208
Polarity: Color band denotes cathode
Mounting Position: Any
Weight: 0.015 ounce, 0.4 gram



MAXIMUM RATINGS AND ELECTRICAL CHARACTERISTICS

Ratings at 25°C ambient temperature unless otherwise specified.
 Single phase, half wave, 60 Hz, resistive or inductive load.
 For capacitive load, derate current by 20%.

	SYMBOLS	GP 15A	GP 15B	GP 15D	GP 15G	GP 15J	GP 15K	GP 15M	UNITS
Maximum Recurrent Peak Reverse Voltage	V_{RRM}	50	100	200	400	600	800	1000	Volts
Maximum RMS Voltage	V_{RMS}	35	70	140	280	420	560	700	Volts
Maximum DC Blocking Voltage	V_{DC}	50	100	200	400	600	800	1000	Volts
Maximum Average Forward Rectified Current .375", (9.5mm) Lead Lengths at $T_A = 55^\circ\text{C}$	$I_{(AV)}$				1.5				Amps
Peak Forward Surge Current 8.3ms single half sine-wave superimposed on rated load (JEDEC Method)	I_{FSM}				50.0				Amps
Maximum Instantaneous Forward Voltage at 1.5A	V_F				1.1				Volts
Maximum Full Load Reverse Current, Full Cycle Average .375", (9.5mm) Lead Length $T_A = 55^\circ\text{C}$	$I_{R(AV)}$				100.0				μA
Maximum Reverse Current $T_A = 25^\circ\text{C}$ at Rated DC Blocking Voltage $T_A = 125^\circ\text{C}$	I_R				5.0 200.0				μA
Typical Reverse Recovery Time (Note 2)	T_{RR}				2.0				μs
Typical Junction Capacitance (Note 1)	C_J				15.0				pf
Typical Thermal Resistance (Note 3)	$R_{\theta JA}$				25.0				$^\circ\text{C/W}$
Operating and Storage Temperature Range	T_J, T_{STG}				-65 to +175				$^\circ\text{C}$

NOTES:

1. Measured at 1.0 MHz and applied reverse voltage of 4.0 Vdc.
2. Reverse Recovery Conditions $I_F = 0.5\text{A}$, $I_R = 1.0\text{A}$, recover to 0.25A.
3. Thermal Resistance from Junction to Ambient at .375" (9.5mm) Lead Lengths, P.C. Board Mounted.

RATINGS AND CHARACTERISTIC CURVES GP15A THRU GP15M

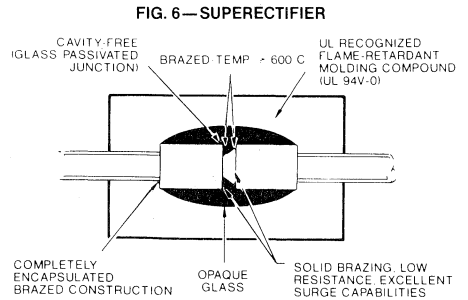
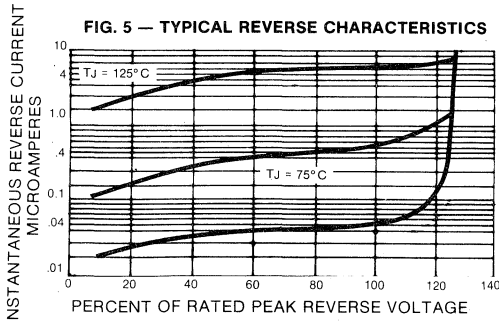
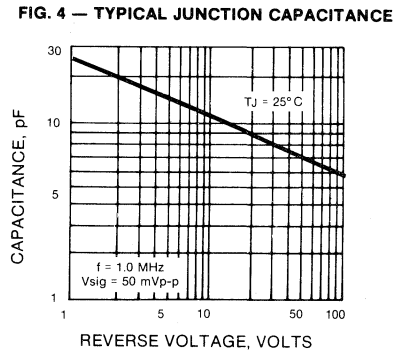
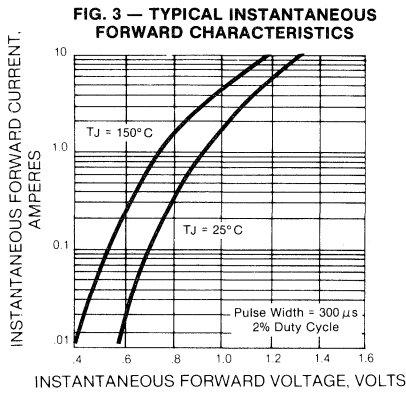
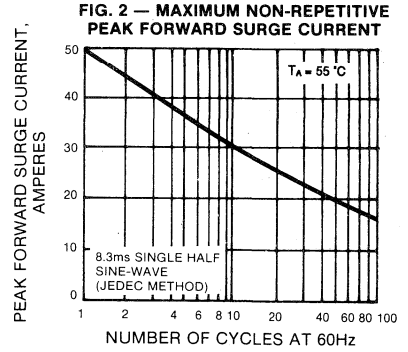
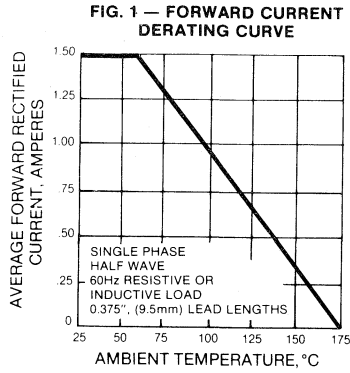

AGP15-200 THRU AGP15-800

MINIATURE GLASS PASSIVATED JUNCTION PLASTIC CONTROLLED AVALANCHE RECTIFIER

Voltage - 200 to 800 Volts Current - 1.5 Amperes

FEATURES

- ◆ High temperature metallurgically bonded constructed rectifiers
- ◆ Controlled Avalanche characteristic combined with the ability to dissipate reverse power
- ◆ Plastic package has Underwriters Laboratory Flammability Classification 94V-0
- ◆ Glass passivated cavity-free junction in D0-15 package
- ◆ 1.5 Ampere operation at $T_A = 55^\circ\text{C}$ with no thermal runaway
- ◆ Typical I_R less than $0.1 \mu\text{A}$
- ◆ Capable of meeting environmental standards of MIL-S-19500
- ◆ High temperature soldering guaranteed $350^\circ\text{C}/10$ seconds/.375", (9.5mm) lead length at 5 lbs., (2.3kg) tension

PATENTED*

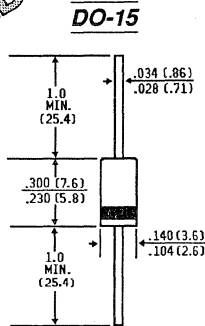

Dimensions in inches and (millimeters)

* Glass-plastic encapsulation technique is covered by Patent No. 3,996,602 of 1976; brazed-lead assembly to Patent No. 3,930,306 of 1976 and glass composition by Patent No. 3,752,701 of 1973



MECHANICAL DATA

- Case:** Molded plastic over glass
Terminals: Plated Axial leads, solderable per MIL-STD-202, Method 208
Polarity: Color band denotes cathode
Mounting Position: Any **Weight:** 0.0154 ounce, .4 gram

MAXIMUM RATINGS AND ELECTRICAL CHARACTERISTICS

Ratings at 25°C ambient temperature unless otherwise specified. Resistive or inductive load. For capacitive load, derate current by 20%.

	SYMBOLS	AGP15-200	AGP15-400	AGP15-600	AGP15-800	UNITS
Maximum Recurrent Peak Reverse Voltage	V_{RRM}	200	400	600	800	Volts
Maximum RMS Voltage	V_{RMS}	140	280	420	560	Volts
Maximum DC Blocking Voltage	V_{DC}	200	400	600	800	Volts
Minimum Avalanche Breakdown Voltage at $100 \mu\text{A}$	V_{BR}	240	450	675	880	Volts
Maximum Avalanche Breakdown Voltage at $100 \mu\text{A}$	V_{BR}	500	750	1000	1200	Volts
Maximum Peak Power Dissipation in the Avalanche Region $20 \mu\text{s}$ Pulse	P_{RM}	500.0				Watts
Maximum Average Forward Rectified Current .375", (9.5mm) Lead Lengths at $T_A = 55^\circ\text{C}$	$I_{(AV)}$	1.5				Amps
Peak Forward Surge Current 8.3ms single half sine-wave superimposed on rated load (JEDEC Method)	I_{FSM}	50.0				Amps
Maximum Instantaneous Forward Voltage at 1.5A	V_F	1.1				Volts
Maximum Reverse Current at Rated DC Blocking Voltage	I_R	5.0				μA
Maximum Full Load Reverse Current, Full Cycle Average, .375", (9.5mm) Lead Length at $T_A = 55^\circ\text{C}$	$I_{R(AV)}$	100.0				μA
Typical Reverse Recovery Time (Note 2)	T_{RR}	2.0				μs
Typical Junction Capacitance (Note 1)	C_J	15.0				pf
Typical Thermal Resistance (Note 3)	$R_{\theta JA}$	25.0				$^\circ\text{C}/\text{W}$
Operating and Storage Temperature Range	T_J, T_{STG}	-65 to +175				$^\circ\text{C}$

NOTES: 1. Measured at 1 MHz and applied reverse voltage of 4.0 Volts. 2. Reverse Recovery Test Conditions: $I_F = 0.5\text{A}$, $I_R = 1.0\text{A}$, recover to 0.25A. 3. Thermal Resistance from Junction to Ambient at .375" (9.5mm) Lead Lengths, P.C. Board Mounted.

RATINGS AND CHARACTERISTIC CURVES AGP15-200 THRU AGP15-800

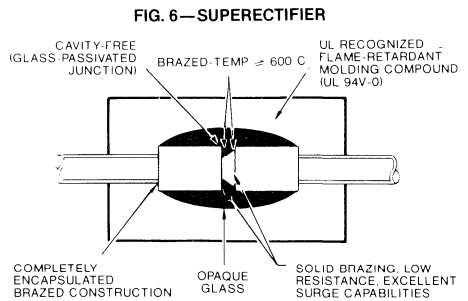
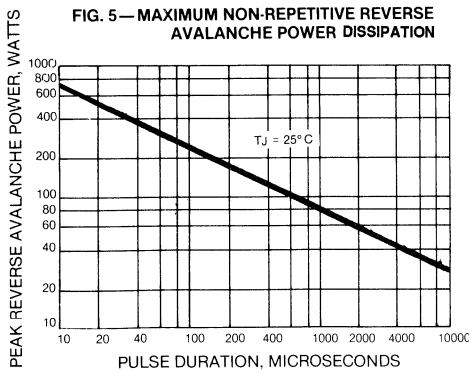
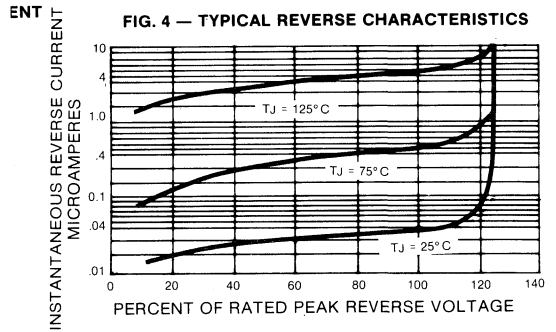
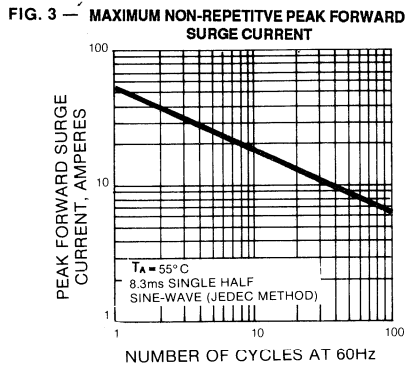
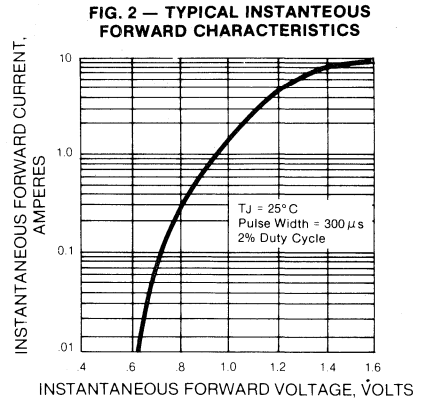
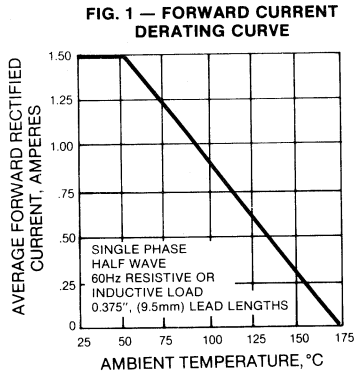

GP20A THRU GP20J

GLASS PASSIVATED JUNCTION PLASTIC RECTIFIER

Voltage - 50 to 600 Volts Current - 2.0 Amperes

FEATURES

- ◆ High temperature metallurgically bonded constructed rectifiers
- ◆ Plastic package has Underwriters Laboratory Flammability Classification 94V-0
- ◆ Glass passivated cavity-free junction
- ◆ 2.0 Ampere operation at $T_A = 55^\circ\text{C}$ with no thermal runaway
- ◆ Typical I_R less than $0.1 \mu\text{A}$
- ◆ Capable of meeting environmental standards of MIL-S-19500
- ◆ High temperature soldering guaranteed: $350^\circ\text{C}/10$ seconds/.375", (9.5mm) lead length at 5 lbs., (2.3kg) tension

PATENTED*

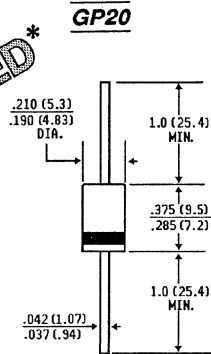

Dimensions in inches and (millimeters)

* Glass-plastic encapsulation technique is covered by Patent No. 3,996,602 of 1976; brazed-lead assembly to Patent No. 3,930,306 of 1976 and glass composition by Patent No. 3,752,701 of 1973



MECHANICAL DATA

Case: Molded plastic over glass
Terminals: Plated Axial leads, solderable per MIL-STD-202, Method 208
Polarity: Band denotes cathode
Mounting Position: Any
Weight: 0.03 ounce, 0.8 gram

MAXIMUM RATINGS AND ELECTRICAL CHARACTERISTICS

Ratings at 25°C ambient temperature unless otherwise specified 60 Hz Resistive or inductive load.
 For capacitive load, derate current by 20%.

	SYMBOLS	GP 20A	GP 20B	GP 20D	GP 20G	GP 20J	UNITS
Maximum Recurrent Peak Reverse Voltage	V_{RRM}	50	100	200	400	600	Volts
Maximum RMS Voltage	V_{RMS}	35	70	140	280	420	Volts
Maximum DC Blocking Voltage	V_{DC}	50	100	200	400	600	Volts
Maximum Average Forward Rectified Current .375", (9.5mm) Lead Lengths at $T_A = 55^\circ\text{C}$	$I_{(AV)}$	2.0					Amps
Peak Forward Surge Current 8.3ms single half sine-wave superimposed on rated load (JEDEC Method)	I_{FSM}	65.0					Amps
Maximum Instantaneous Forward Voltage at 2.0A	V_F	1.2	1.1				Volts
Maximum Reverse Current at Rated DC Blocking Voltage $T_A = 25^\circ\text{C}$	I_R	5.0					μA
Maximum Full Load Reverse Current, Full Cycle Average, .375" (9.5mm) Lead Length $T_A = 55^\circ\text{C}$	$I_{R(AV)}$	100					μA
Typical Reverse Recovery Time (Note 1)	T_{RR}	2.5					μs
Typical Junction Capacitance (Note 2)	C_J	40					pf
Typical Thermal Resistance (Note 3)	$R_{\theta JA}$	16.0					$^\circ\text{C/W}$
Operating and Storage Temperature Range	T_J, T_{STG}	-65 to +175					$^\circ\text{C}$

NOTES:

1. Measured at 1 MHz and applied reverse voltage of 4.0 volts.
2. Reverse Recovery Test Conditions : $I_F = 0.5\text{A}$, $I_R = 1.0\text{A}$, $I_{rr} = 0.25\text{A}$.
3. Thermal Resistance from Junction to Ambient at .375" (9.5mm) Lead Lengths, P.C. Board Mounted.

RATINGS AND CHARACTERISTIC CURVES GP20A THRU GP20J

FIG. 1 — FORWARD CURRENT DERATING CURVE

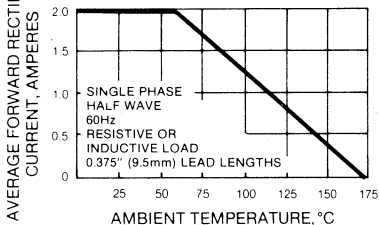

FIG. 2 — MAXIMUM NON-REPETITIVE PEAK FORWARD SURGE CURRENT

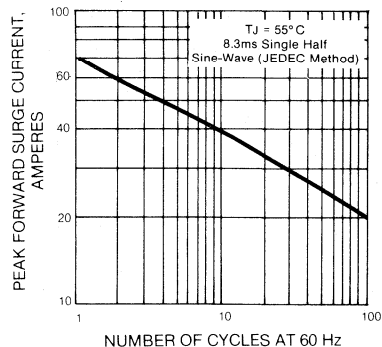

FIG. 3 — TYPICAL JUNCTION CAPACITANCE

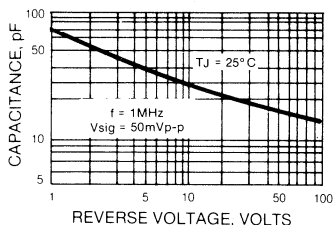

FIG. 4 — TYPICAL INSTANTANEOUS FORWARD CHARACTERISTICS

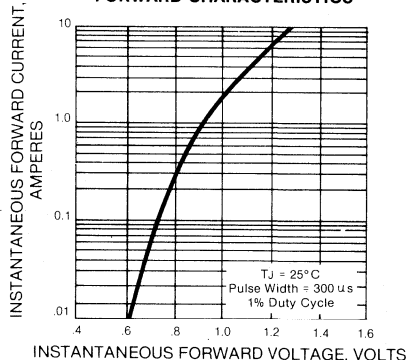

FIG. 5 — TYPICAL REVERSE CHARACTERISTICS

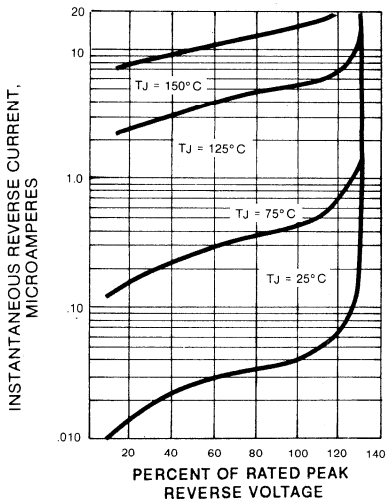
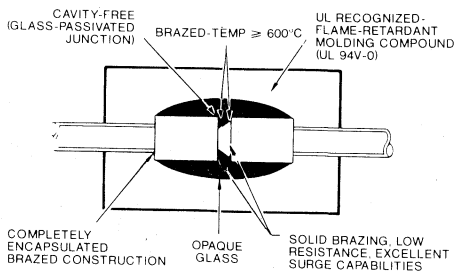

FIG. 6 — SUPERRECTIFIER



BY126MGP, BY127MGP / BY226MGP, BY227MGP

MINIATURE GLASS PASSIVATED JUNCTION PLASTIC RECTIFIER
Voltage - 650 to 1250 Volts Current - 1.5 and 1.75 Amperes

FEATURES

- ◆ High temperature metallurgically bonded constructed rectifiers
- ◆ Plastic package has Underwriters Laboratory Flammability Classification 94V-0
- ◆ Glass passivated cavity-free junction in D0-15 package
- ◆ 1.5 Ampere operation at $T_A = 55^\circ\text{C}$ with no thermal runaway
- ◆ Typical I_R less than $0.1 \mu\text{A}$
- ◆ Capable of meeting environmental standards of MIL-S-19500
- ◆ High temperature soldering guaranteed: $350^\circ\text{C}/10$ seconds/.375", (9.5mm) lead length at 5 lbs., (2.3kg) tension



PATENTED*

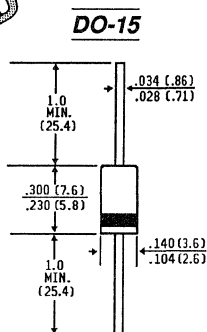

Dimensions in inches and (millimeters)

* Glass-plastic encapsulation technique is covered by Patent No. 3,996,602 of 1976; brazed-lead assembly to Patent No. 3,930,306 of 1976 and glass composition by Patent No. 3,752,701 of 1973



MECHANICAL DATA

Case: Molded plastic over glass
Terminals: Plated Axial leads, solderable per MIL-STD-202, Method 208
Polarity: Color band denotes cathode
Mounting Position: Any
Weight: 0.015 ounce, 0.4 gram

MAXIMUM RATINGS AND ELECTRICAL CHARACTERISTICS

Ratings at 25°C ambient temperature unless otherwise specified. 50 Hz, resistive or inductive load. For capacitive load, derate current by 20%.

	SYMBOLS	BY126MGP	BY127MGP	BY226MGP	BY227MGP	UNITS
Maximum Recurrent Peak Reverse Voltage	V_{RRM}	650	1250	650	1250	Volts
Maximum RMS Voltage	V_{RMS}	455	875	455	875	Volts
Maximum DC Blocking Voltage	V_{DC}	650	1250	650	1250	Volts
Maximum Average Forward Rectified Current .375", (9.5mm) Lead Lengths at $T_A = 55^\circ\text{C}$	$I_{(AV)}$	1.5		1.75		Amps
Peak Forward Surge Current 10ms single half sine-wave superimposed on rated load at $T_A = 25^\circ\text{C}$	I_{FSM}	50.0		60.0		Amps
Maximum Instantaneous Forward Voltage at 5.0A	V_F	1.5				Volts
Maximum Reverse Current at Rated DC Blocking Voltage $T_A = 25^\circ\text{C}$	I_R	5.0				μA
Maximum Full Load Reverse Current, Full Cycle Average, .375" (9.5mm) Lead Length at $T_A = 55^\circ\text{C}$	$I_{R(AV)}$	100.0				μA
Typical Reverse Recovery Time (Note 2)	T_{RR}	2.0				μs
Typical Junction Capacitance (Note 1)	C_J	15.0				pf
Typical Thermal Resistance (Note 3)	$R_{\theta JA}$	25.0				$^\circ\text{C}/\text{W}$
Operating and Storage Temperature Range	T_J, T_{STG}	-65 to +175				$^\circ\text{C}$

NOTES:

1. Measured at 1.0 MHz and applied reverse voltage of 4.0 Vdc.
2. Reverse Recovery Test Conditions: $I_F = 0.5\text{A}$, $I_R = 1.0\text{A}$, recover to 0.25A.
3. Thermal Resistance from Junction to Ambient at .375" (9.5mm) Lead Lengths, P.C. Board Mounted.

**RATINGS AND CHARACTERISTIC CURVES
BY126MGP, BY127MGP, BY226MGP & BY227MGP**

FIG. 1 — FORWARD CURRENT DERATING CURVE

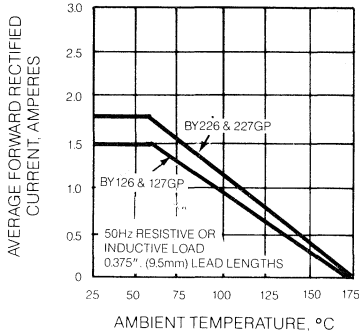

FIG. 2 — MAXIMUM NON-REPETITIVE PEAK FORWARD SURGE CURRENT

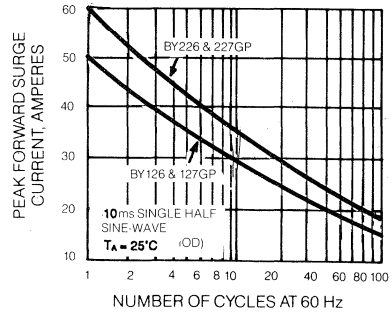

FIG. 3 — TYPICAL INSTANTANEOUS FORWARD CHARACTERISTICS

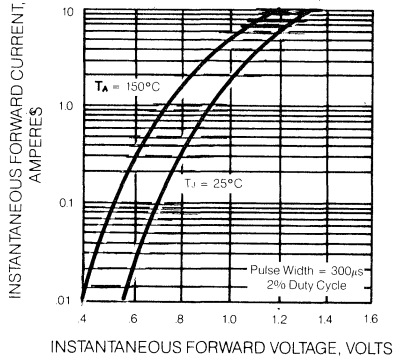

FIG. 4 — TYPICAL JUNCTION CAPACITANCE

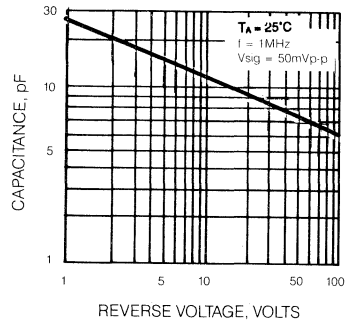

FIG. 5 — TYPICAL REVERSE CHARACTERISTICS

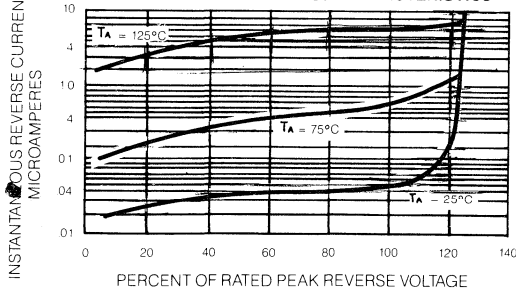
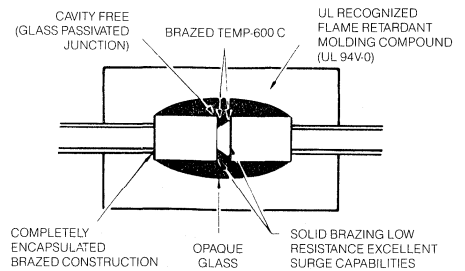

FIG. 6 — SUPERRECTIFIER



**GENERAL
INSTRUMENT**

1N5624GP THRU 1N5627GP

GLASS PASSIVATED JUNCTION PLASTIC RECTIFIER

Voltage - 200 to 800 Volts Current -3.0 Amperes

FEATURES

PATENTED*

DO-201AD

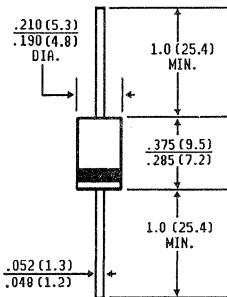

- ◆ High temperature metallurgically bonded constructed rectifiers
- ◆ Plastic package has Underwriters Laboratory Flammability Classification 94V-0
- ◆ Glass passivated cavity-free junction in DO-201AD package
- ◆ 3.0 Ampere operation at $T_A = 70^\circ\text{C}$ with no thermal runaway
- ◆ Typical I_R less than $0.1 \mu\text{A}$
- ◆ Capable of meeting environmental standards of MIL-S-19500
- ◆ High temperature soldering guaranteed $350^\circ\text{C}/10$ seconds/.375", (9.5mm) lead length at 5 lbs., (2.3kg) tension

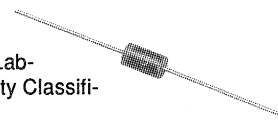

Dimensions in inches and (millimeters)

* Glass-plastic encapsulation technique is covered by Patent No. 3,996,602 of 1976; brazed lead assembly to Patent No. 3,930,306 of 1976 and glass composition by Patent No. 3,752,701 of 1973



MECHANICAL DATA

- Case:** Molded plastic over glass
Terminals: Axial leads, solderable per MIL-STD-202, Method 208
Polarity: Color band denotes cathode
Mounting Position: Any
Weight: 0.04 ounce, 1.12 grams

MAXIMUM RATINGS AND ELECTRICAL CHARACTERISTICS

Ratings at 25°C ambient temperature unless otherwise specified. Single phase, half wave, 60 Hz, resistive or inductive load. For capacitive load, derate current by 20%.

	SYMBOLS	1N5624GP	1N5625GP	1N5626GP	1N5627GP	UNITS
* Maximum Recurrent Peak Reverse Voltage	V_{RRM}	200	400	600	800	Volts
* Maximum DC Blocking Voltage	V_{DC}	200	400	600	800	Volts
* Maximum Average Forward Rectified Current .375", (9.5mm) Lead Lengths at $T_A = 70^\circ\text{C}$	$I_{(AV)}$	3.0				Amps
* Peak Forward Surge Current 8.3ms single half sine-wave superimposed on rated load (JEDEC Method)	I_{FSM}	125				Amps
* Maximum Instantaneous Forward Voltage at 3.0A $T_A = 25^\circ\text{C}$ $T_A = 70^\circ\text{C}$	V_F	1.0 .95				Volts
Maximum Reverse Current at Rated DC Blocking Voltage $T_A = 25^\circ\text{C}$ $T_A = 150^\circ\text{C}$	$I_{R(AV)}$	300		200		μA
Maximum Full Load Reverse Current, Full Cycle Average, .375" (9.5mm) Lead Length $T_A = 70^\circ\text{C}$	I_R	200				μA
Typical Reverse Recovery Time (Note 2)	T_{RR}	3.0				μs
Typical Junction Capacitance (Note 1)	C_J	40.0				pf
Typical Thermal Resistance (Note 3)	$R_{\theta JA}$	15.0				$^\circ\text{C}/\text{W}$
Operating and Storage Temperature Range	T_J, T_{STG}	-65 to +175				$^\circ\text{C}$

NOTES:

1. Measured at 1.0 MHz and applied reverse voltage of 4.0 Vdc.
2. Reverse Recovery Test Conditions : $I_F = 0.5\text{A}$, $I_R = 1.0\text{A}$, recover to 0.25A.
3. Thermal Resistance from Junction to Ambient at .375" (9.5mm) Lead Lengths, P.C. Board Mounted.
* JEDEC Registered Value

RATINGS AND CHARACTERISTIC CURVES 1N5624GP THRU 1N5627GP

FIG. 1 — FORWARD CURRENT DERATING CURVE

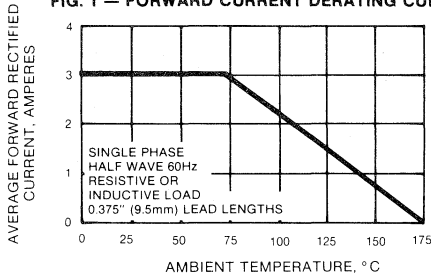

FIG. 2 — MAXIMUM NON-REPETITIVE PEAK FORWARD SURGE CURRENT

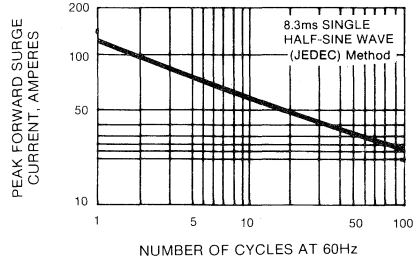

FIG. 3 — TYPICAL INSTANTANEOUS FORWARD CHARACTERISTICS

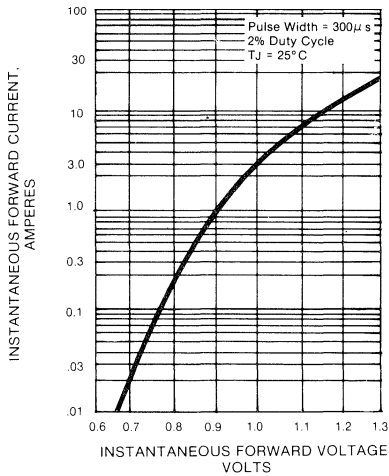

FIG. 4 — TYPICAL JUNCTION CAPACITANCE

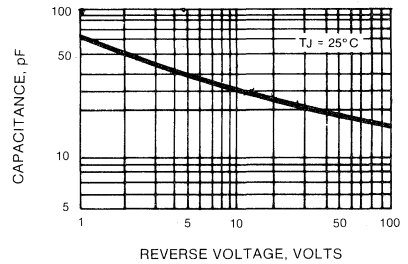

FIG. 5 — TYPICAL REVERSE CHARACTERISTICS

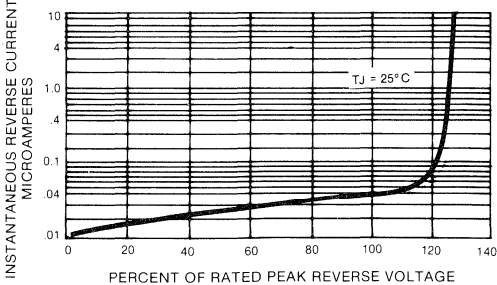
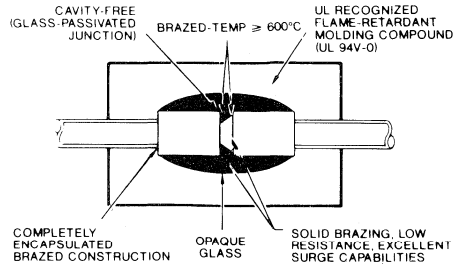

FIG. 6 — SUPERRECTIFIER



GP30A THRU GP30M

GLASS PASSIVATED SILICON JUNCTION PLASTIC RECTIFIER

Voltage - 50 to 1000 Volts Current - 3.0 Amperes

FEATURES

PATENTED*

DO-201AD

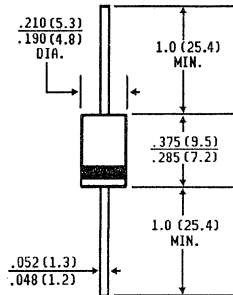

Dimensions in inches and (millimeters)

* Glass-plastic encapsulation technique is covered by Patent No. 3,996,602 of 1976; brazed-lead assembly to Patent No. 3,930,306 of 1976 and glass composition by Patent No. 3,752,701 of 1973



- ◆ High temperature metallurgically bonded constructed rectifiers
- ◆ Plastic package has Underwriters Laboratory Flammability Classification 94V-0
- ◆ Glass passivated cavity-free junction in DO-201AD package
- ◆ 3.0 Ampere operation at $T_A = 55^\circ\text{C}$ with no thermal runaway
- ◆ Typical I_R less than $0.1 \mu\text{A}$
- ◆ Capable of meeting environmental standards of MIL-S-19500
- ◆ High temperature soldering guaranteed: $350^\circ\text{C}/10$ seconds/.375", (9.5mm) lead length at 5 lbs., (2.3kg) tension

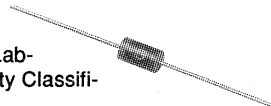

MECHANICAL DATA

Case: Molded plastic over glass
Terminals: Axial leads, solderable per MIL-STD-202, Method 208
Polarity: Color band denotes cathode
Mounting Position: Any
Weight: 0.04 ounce, 1.12 grams

MAXIMUM RATINGS AND ELECTRICAL CHARACTERISTICS

Ratings at 25°C ambient temperature unless otherwise specified. 60 Hz resistive or inductive load. For capacitive load, derate current by 20%.

	SYMBOLS	GP 30A	GP 30B	GP 30D	GP 30G	GP 30J	GP 30K	GP 30M	UNITS
Maximum Recurrent Peak Reverse Voltage	V_{RRM}	50	100	200	400	600	800	1000	Volts
Maximum RMS Voltage	V_{RMS}	35	70	140	280	420	560	700	Volts
Maximum DC Blocking Voltage	V_{DC}	50	100	200	400	600	800	1000	Volts
Maximum Average Forward Rectified Current .375", (9.5mm) Lead Lengths at $T_A = 55^\circ\text{C}$	$I_{(AV)}$	3.0							Amps
Peak Forward Surge Current 8.3ms single half sine-wave superimposed on rated load (JEDEC Method)	I_{FSM}	125							Amps
Maximum Instantaneous Forward Voltage at 3.0A	V_F	1.2		1.1				Volts	
Maximum Reverse Current at Rated DC Blocking Voltage	I_R	5.0							μA
Maximum Full Load Reverse Current, Full Cycle Average .375", (9.5mm) Lead Length $T_A = 55^\circ\text{C}$	$I_{R(AV)}$	100							μA
Maximum Reverse Recovery Time (Note 2) $T_J = 25^\circ\text{C}$	T_{RR}	3.0							μs
Typical Junction Capacitance (Note 1)	C_J	40.0							pf
Typical Thermal Resistance (Note 3)	$R_{\theta JA}$	15.0							$^\circ\text{C}/\text{W}$
Operating and Storage Temperature Range	T_J, T_{STG}	-65 to +175							$^\circ\text{C}$

NOTES:

1. Measured at 1.0 MHz and applied reverse voltage of 4.0 Volts.
2. Reverse Recovery Test Conditions: $I_F = .5\text{A}$, $I_R = 1\text{A}$, $I_{rr} = .25\text{A}$.
3. Thermal Resistance from Junction to Ambient at .375" (9.5mm) Lead Lengths, P.C. Board Mounted.

RATINGS AND CHARACTERISTIC CURVES GP30A THRU GP30M

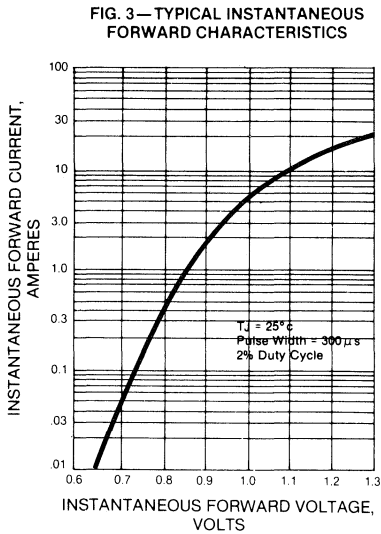
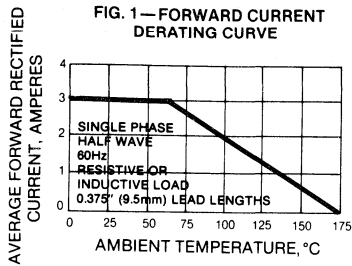

FIG. 5 — TYPICAL JUNCTION CAPACITANCE

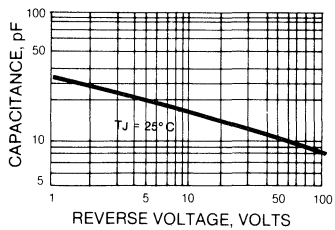

FIG. 2 — MAXIMUM NON-REPETITIVE SURGE CURRENT

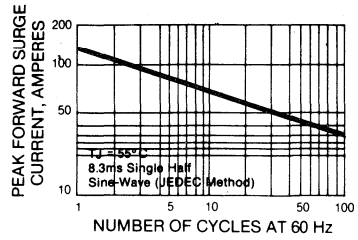

FIG. 4 — TYPICAL REVERSE CHARACTERISTICS

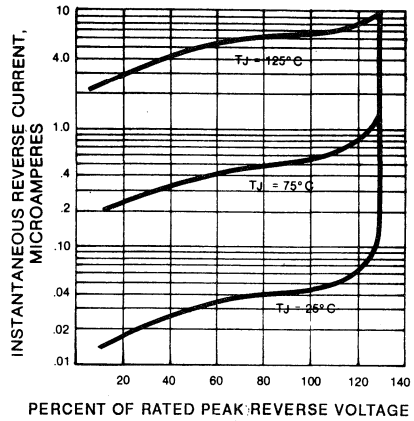
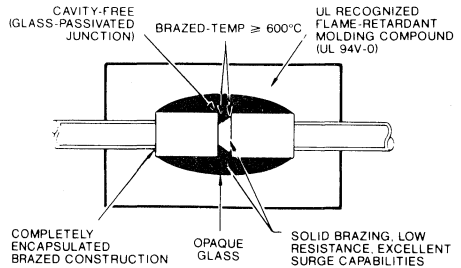

FIG. 6 — SUPERRECTIFIER



**SUPERECTIFIER ZENER
REGULATOR DIODE**

***1.5 WATT
100 TO 200 VOLTS***

**GENERAL
INSTRUMENT**

ZGP10-100 THRU ZGP10-200

MINIATURE GLASS PASSIVATED JUNCTION PLASTIC ZENER REGULATOR DIODE

Voltage - 100 to 200 Volts Power Rating - 1.5 Watts

FEATURES

PATENTED*

DO-41

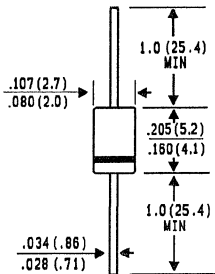

Dimensions in inches and (millimeters)

* Glass-plastic encapsulation technique is covered by Patent No. 3,996,602 of 1976; brazed-lead assembly to Patent No. 3,930,306 of 1976 and glass composition by Patent No. 3,752,701 of 1973



- ◆ High temperature metallurgically bonded constructed rectifiers
- ◆ Plastic package has Underwriters Laboratory Flammability Classification 94V-0
- ◆ Low zener impedance
- ◆ Excellent clamping capability
- ◆ Glass passivated cavity-free junction in DO-41 package
- ◆ Capable of meeting environmental standards of MIL-S-19500
- ◆ High temperature soldering guaranteed: 350°C/10 seconds/.375", (9.5mm) lead length at 5 lbs., (2.3kg) tension

MECHANICAL DATA

Case: Molded plastic over glass

Terminals: Plated Axial leads, solderable per MIL-STD-202, Method 208

Polarity: Color band denotes cathode

Mounting Position: Any

Weight: 0.012 ounce, .3 gram

MAXIMUM RATINGS AND ELECTRICAL CHARACTERISTICS

Ratings at 25°C ambient temperature unless otherwise specified.

OPERATING AND STORAGE TEMPERATURE T_J, T_{STG} -65°C to +175°C

TYPE	Zener Breakdown Voltage at 5mA		Maximum Zener Dynamic Impedance				Maximum Reverse Current at Measurement Voltage, V_R			Maximum Forward Voltage at .50A	Maximum Continuous Regulator Current*
	MIN	MAX	Z_{ZT}	Z_{ZT}	Z_{ZK}	Z_{ZK}	V_R	25°C	100°C	V_F	I_{ZM}
	Volts		mA	Ohms	mA	Ohms	Volts	µA	µA	Volts	mA
ZGP10-100	80	120	5	500	.25	5000	60	0.5	100	1.0	10.
ZGP10-110	88	132	5	600	.25	5000	70	0.5	100	1.0	9.1
ZGP10-120	96	144	5	700	.25	5000	80	0.5	100	1.0	8.3
ZGP10-130	104	156	5	800	.25	5000	90	0.5	100	1.0	7.7
ZGP10-140	112	168	5	900	.25	5500	100	0.5	100	1.0	7.1
ZGP10-150	120	180	5	1000	.25	6000	110	0.5	100	1.0	6.6
ZGP10-160	140	170	5	1100	.25	6500	120	0.5	100	1.0	6.3
ZGP10-170	136	204	5	1200	.25	7000	130	0.5	100	1.0	5.9
ZGP10-180	144	216	5	1300	.25	7000	140	0.5	100	1.0	5.6
ZGP10-190	152	228	5	1400	.25	7500	150	0.5	100	1.0	5.3
ZGP10-200	160	240	5	1500	.25	8000	160	0.5	100	1.0	5.0

Standard + - 20%, Suffix A+/-10%, Suffix B+5%.

*Temperature rating at specified regulator current is $T_L = 30^\circ\text{C}$

**Maximum continuous power dissipation at $T_L = 75^\circ\text{C}$ lead length .375", 9.5mm is 1.5 Watts

RATINGS AND CHARACTERISTIC CURVES ZGP10-100 THRU ZGP10-200

FIG. 1 — MAXIMUM CONTINUOUS POWER DISSIPATION

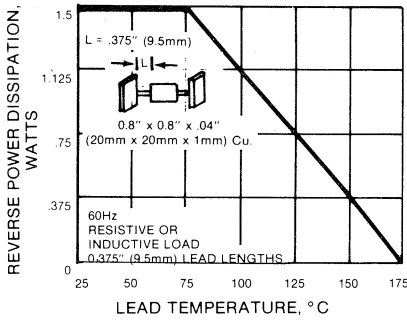

FIG. 2 — TYPICAL ZENER IMPEDANCE

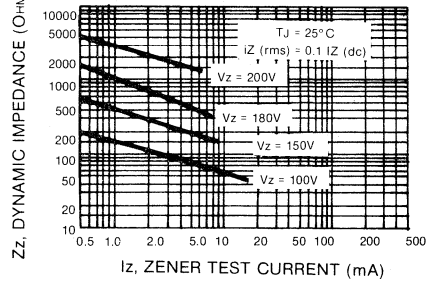

FIG. 3 — TYPICAL INSTANTANEOUS FORWARD CHARACTERISTICS

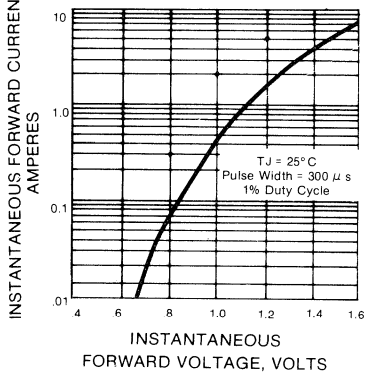

FIG. 4 — TYPICAL REVERSE CHARACTERISTICS

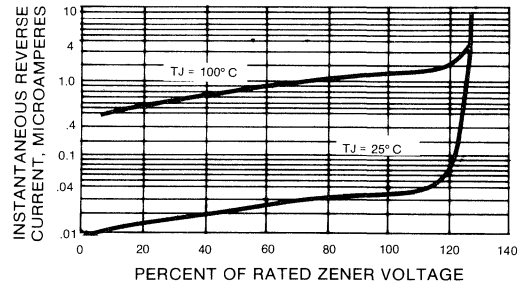

FIG. 5 — TYPICAL TEMPERATURE COEFFICIENTS

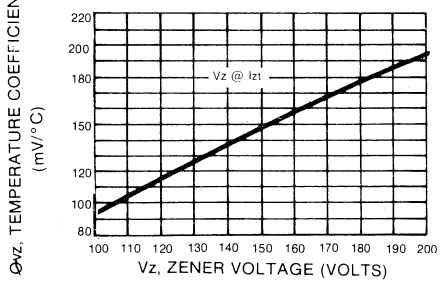
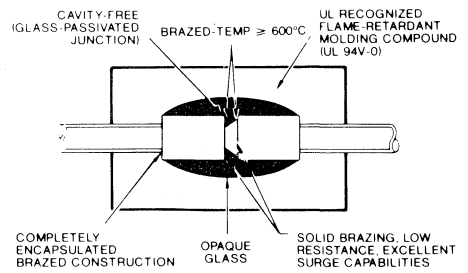

FIG. 6 — SUPERRECTIFIER



**FAST-RECOVERY
SUPERECTIFIERS**

***.40 AMPERES THRU 3.0 AMPERES
50 VOLTS TO 2000 VOLTS***

**GENERAL
INSTRUMENT**

PHOTOFLASH RECTIFIER RGP02 SERIES

MINIATURE GLASS PASSIVATED JUNCTION FAST SWITCHING RECTIFIER

Voltage - 1200 to 2000 Volts Current - 0.5 Amperes

FEATURES

PATENTED*

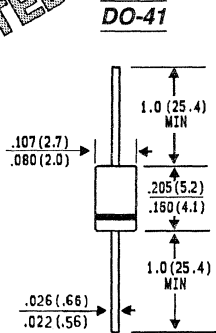

Dimensions in inches and (millimeters)

- ◆ High temperature metallurgically bonded constructed rectifiers
- ◆ For use in high frequency rectifier circuits
- ◆ Plastic package has Underwriters Laboratory Flammability Classification 94V-0
- ◆ Fast switching for high efficiency
- ◆ Glass passivated cavity-free junction in D0-41 package
- ◆ 0.5 Ampere operation at $T_A = 55^\circ\text{C}$ with no thermal runaway
- ◆ Typical I_R less than $0.1 \mu\text{A}$
- ◆ Capable of meeting environmental standards of MIL-S-19500
- ◆ High temperature soldering guaranteed $350^\circ\text{C}/10$ seconds/.375", (9.5mm) lead length at 5 lbs., (2.3kg) tension

* Glass-plastic encapsulation technique is covered by Patent No. 3,996,602 of 1976; brazed-lead assembly to Patent No. 3,930,306 of 1976 and glass composition by Patent No. 3,752,701 of 1973

MECHANICAL DATA

- Case:** Molded plastic over glass
Terminals: Axial leads, solderable per MIL-STD-202, Method 208
Polarity: Color band denotes cathode
Mounting Position: Any
Weight: 0.012 ounce, .3 gram

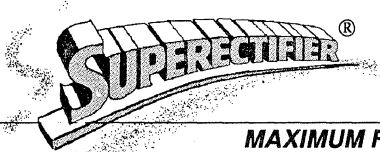

MAXIMUM RATINGS AND ELECTRICAL CHARACTERISTICS

Ratings at 25°C ambient temperature unless otherwise specified. Resistive or inductive load. For capacitive load, derate current by 20%.

	SYMBOLS	RGP02 -12 E	RGP02 -14 E	RGP02 -16 E	RGP02 -18 E	RGP02 -20 E	UNITS
Maximum Recurrent Peak Reverse Voltage	V_{RRM}	1200	1400	1600	1800	2000	Volts
Maximum RMS Voltage	V_{RMS}	840	980	1120	1260	1400	Volts
Maximum DC Blocking Voltage	V_{DC}	1200	1400	1600	1800	2000	Volts
Maximum Average Forward Rectified Current .375", (9.5mm) Lead Lengths at $T_A = 55^\circ\text{C}$	$I_{(AV)}$	0.5					Amps
Peak Forward Surge Current 8.3ms single half sine-wave superimposed on rated load at $T_A = 25^\circ\text{C}$	I_{FSM}	20.0					Amps
Maximum Instantaneous Forward Voltage at 0.1 A	V_F	1.8					Volts
Maximum DC Reverse Current $T_A = 25^\circ\text{C}$ at Rated DC Blocking Voltage $T_A = 125^\circ\text{C}$	I_R	50.0					μA
Maximum Reverse Recovery Time (Note 1) $T_J = 25^\circ\text{C}$	T_{RR}	300					ns
Typical Junction Capacitance (Note 2)	C_J	5.0					pf
Typical Thermal Resistance (Note 3)	$R_{\theta JA}$	50.0					$^\circ\text{C}/\text{W}$
Operating and Storage Temperature Range	T_J, T_{STG}	-65 to +175					$^\circ\text{C}$

NOTES:

1. Reverse Recovery Test Conditions : $I_F = 0.5\text{A}$, $I_R = 1.0\text{A}$, $I_{rr} = .25\text{A}$.
2. Measured at 1.0 MHz and applied reverse voltage of 4.0 V_{olts} .
3. Thermal Resistance from Junction to Ambient at .375" (9.5mm) Lead Lengths, P.C. Board Mounted.

RATINGS AND CHARACTERISTIC CURVES RGP02 SERIES

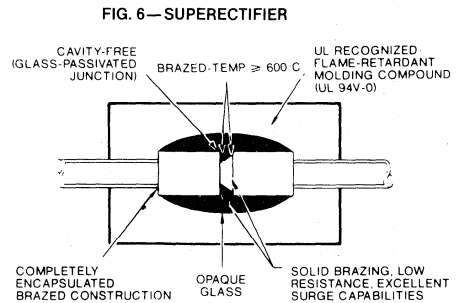
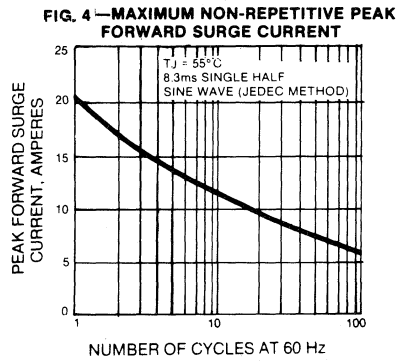
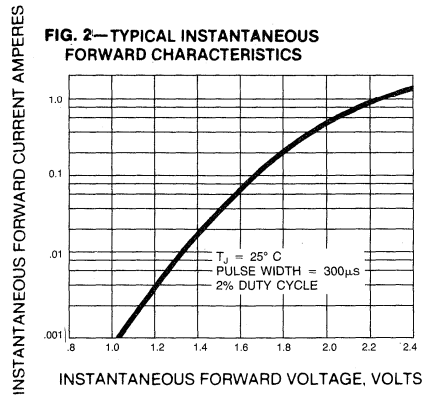
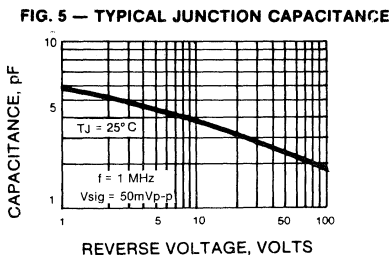
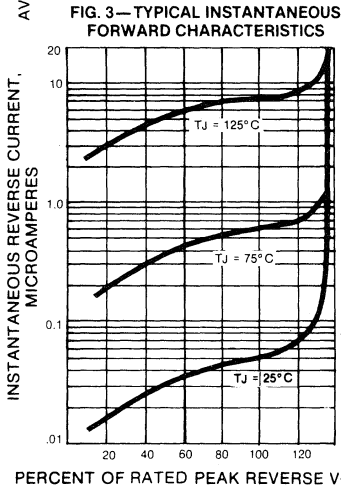
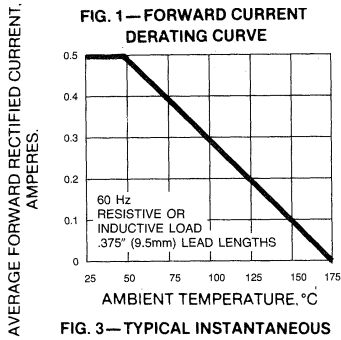

**GENERAL
INSTRUMENT**

BY206GP THRU BY207GP

MINIATURE GLASS PASSIVATED JUNCTION FAST SWITCHING RECTIFIER

Voltage - 350 to 600 Volts Current - 0.4 Amperes

FEATURES

PATENTED*

DO-41

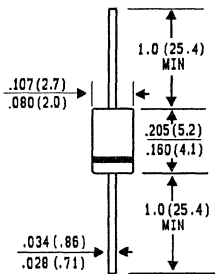

Dimensions in inches and (millimeters)

- ◆ High temperature metallurgically bonded constructed rectifiers
- ◆ For use in high frequency rectifier circuits
- ◆ Plastic package has Underwriters Laboratory Flammability Classification 94V-0
- ◆ Fast switching for high efficiency
- ◆ Glass passivated cavity-free junction in D0-41 package
- ◆ 0.4 Ampere operation at $T_A = 55^\circ\text{C}$ with no thermal runaway
- ◆ Typical I_R less than $1 \mu\text{A}$
- ◆ Capable of meeting environmental standards of MIL-S-19500
- ◆ High temperature soldering guaranteed $350^\circ\text{C}/10$ seconds/.375", (9.5mm) lead length at 5 lbs., (2.3kg) tension

* Glass-plastic encapsulation technique is covered by Patent No. 3,996,602 of 1976; brazed -lead assembly to Patent No. 3,930,306 of 1976 and glass composition by Patent No. 3,752,701 of 1973

MECHANICAL DATA

Case: Molded plastic over glass
Terminals: Axial leads, solderable per MIL-STD-202, Method 208
Polarity: Color band denotes cathode
Mounting Position: Any
Weight: 0.012 ounce, .3 gram



MAXIMUM RATINGS AND ELECTRICAL CHARACTERISTICS

Ratings at 25°C ambient temperature unless otherwise specified. Resistive or inductive load. For capacitive load, derate current by 20%.

	SYMBOLS	BY206GP	BY207GP	UNITS
Maximum Recurrent Peak Reverse Voltage	V_{RRM}	350	600	Volts
Maximum RMS Voltage	V_{RMS}	210	350	Volts
Maximum DC Blocking Voltage	V_{DC}	300	500	Volts
Maximum Average Forward Rectified Current .375", (9.5mm) Lead Lengths at $T_A = 55^\circ\text{C}$	$I_{(AV)}$	0.4		Amps
Peak Forward Surge Current 10ms single half sine-wave superimposed on rated load at $T_A = 25^\circ\text{C}$	I_{FSM}	15		Amps
Maximum Instantaneous Forward Voltage at 2.0A $T_J = 150^\circ\text{C}$	V_F	1.5		Volts
Maximum Full Load Reverse Current $T_A=55^\circ\text{C}$ Full Cycle AVerage at $T_J = 125^\circ\text{C}$	I_R	2.0 200	2.0 125	μA
Maximum Reverse Recovery Time (Note 1)	T_{RR}	1.0		μs
Typical Junction Capacitance (Note 2)	C_J	15.0		pf
Typical Thermal Resistance (Note 3)	$R_{\theta JA}$	45.0		$^\circ\text{C/W}$
Operating and Storage Temperature Range	T_J, T_{STG}	-65 to +175		$^\circ\text{C}$

NOTES:

1. Reverse Recovery Test Conditions : $I_F = 0.4\text{A}$, $V_R = 50\text{V}$ di/dt = 0.4/US.
2. Measured at 1 MHz and applied reverse voltage of 4.0 V_{DC}.
3. Thermal Resistance from Junction to Ambient at .375" (9.5mm) Lead Lengths, P.C. Board Mounted.

RATINGS AND CHARACTERISTIC CURVES BY206GP THRU BY207GP

FIG. 1 — FORWARD CURRENT DERATING CURVE

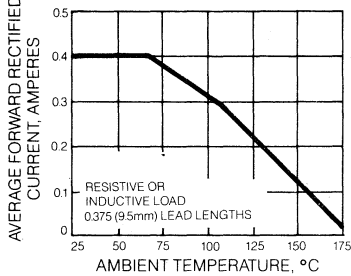

FIG. 2 — TYPICAL INSTANTANEOUS FORWARD CHARACTERISTICS

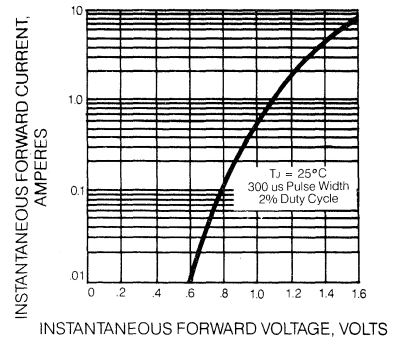

FIG. 3 — MAXIMUM NON-REPETITIVE PEAK FORWARD SURGE CURRENT

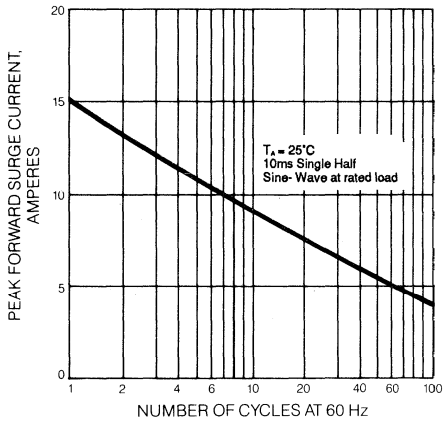

FIG. 4 — TYPICAL JUNCTION CAPACITANCE

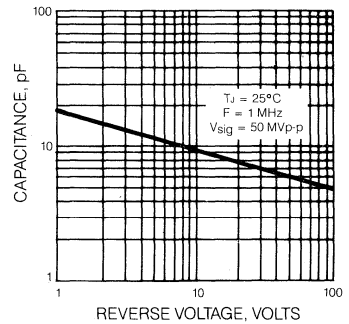

FIG. 5 — REVERSE RECOVERY TIME CHARACTERISTIC

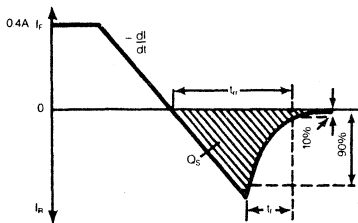
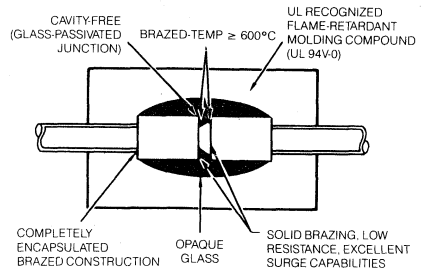

FIG. 6 — SUPERRECTIFIER



BA157GP THRU BA159GP

MINIATURE GLASS PASSIVATED JUNCTION FAST SWITCHING RECTIFIER

Voltage - 400 to 1000 Volts Current - 0.5 Amperes

FEATURES

PATENTED*

DO-41

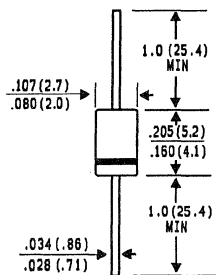

Dimensions in inches and (millimeters)

* Glass-plastic encapsulation technique is covered by Patent No. 3,996,602 of 1976; brazed-lead assembly to Patent No. 3,930,306 of 1976 and glass composition by Patent No. 3,752,701 of 1973

- ◆ High temperature metallurgically bonded constructed rectifiers
- ◆ For use in high frequency rectifier circuits
- ◆ Plastic package has Underwriters Laboratory Flammability Classification 94V-0
- ◆ Fast switching for high efficiency
- ◆ Glass passivated cavity-free junction in D0-41 package
- ◆ 0.5 Ampere operation at $T_A = 55^\circ\text{C}$ with no thermal runaway
- ◆ Typical I_R less than $0.1 \mu\text{A}$
- ◆ Capable of meeting environmental standards of MIL-S-19500
- ◆ High temperature soldering guaranteed $350^\circ\text{C}/10$ seconds/.375", (9.5mm) lead length at 5 lbs., (2.3kg) tension

MECHANICAL DATA

- Case:** Molded plastic over glass
Terminals: Axial leads, solderable per MIL-STD-202, Method 208
Polarity: Color band denotes cathode
Mounting Position: Any
Weight: 0.012 ounce, .3 gram



MAXIMUM RATINGS AND ELECTRICAL CHARACTERISTICS

Ratings at 25°C ambient temperature unless otherwise specified. Resistive or inductive load. For capacitive load, derate current by 20%.

	SYMBOLS	BA157GP	BA158GP	BA159DGP	BA159GP	UNITS
Maximum Recurrent Peak Reverse Voltage	V_{RRM}	400	600	800 ³	1000	Volts
Maximum RMS Voltage	V_{RMS}	280	420	560	700	Volts
Maximum DC Blocking Voltage	V_{DC}	400	600	800	1000	Volts
Maximum Average Forward Rectified Current .375", (9.5mm) Lead Lengths at $T_A = 55^\circ\text{C}$	$I_{(AV)}$	0.5				Amps
Peak Forward Surge Current 10ms single half sine-wave superimposed on rated load at $T_A = 25^\circ\text{C}$	I_{FSM}	20.0				Amps
Maximum Instantaneous Forward Voltage at 1.0A	V_F	1.5				Volts
Maximum DC Reverse Current at Rated DC Blocking Voltage	I_R	5.0				μA
Maximum Reverse Recovery Time (Note 1)	T_{RR}	150	250	500	500	ns
Typical Junction Capacitance (Note 2)	C_J	15.0				pf
Typical Thermal Resistance (Note 3)	$R_{\theta JA}$	50.0				$^\circ\text{C}/\text{W}$
Operating and Storage Temperature Range	T_J, T_{STG}	-65 to +175				$^\circ\text{C}$

NOTES:

1. Reverse Recovery Test Conditions : $I_F = 0.5\text{A}$, $I_R = 1.0\text{A}$, recover to 0.25A.
2. Measured at 1.0 MHz and applied reverse voltage of 4.0 Vdc.
3. Thermal Resistance from Junction to Ambient at .375" (9.5mm) Lead Lengths, P.C. Board Mounted.

RATINGS AND CHARACTERISTIC CURVES BA157GP THRU BA159GP

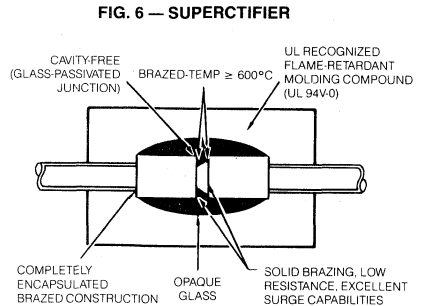
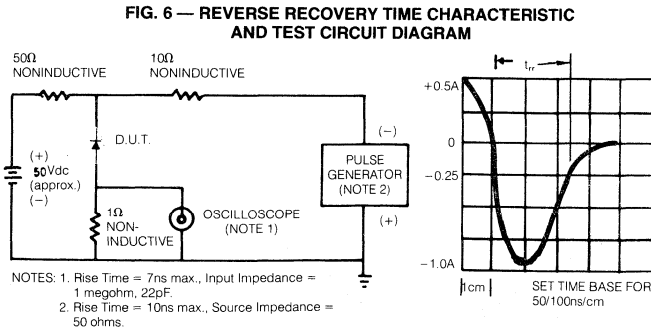
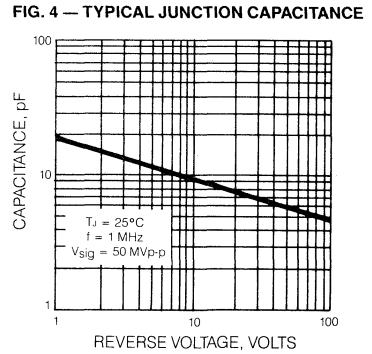
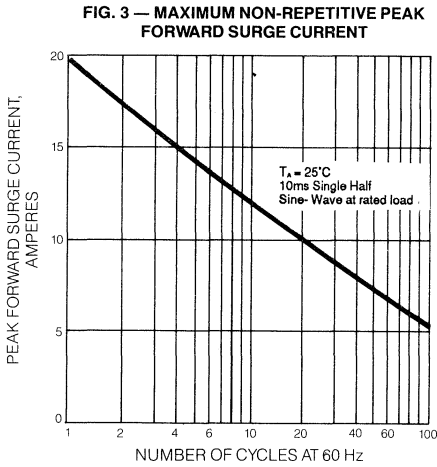
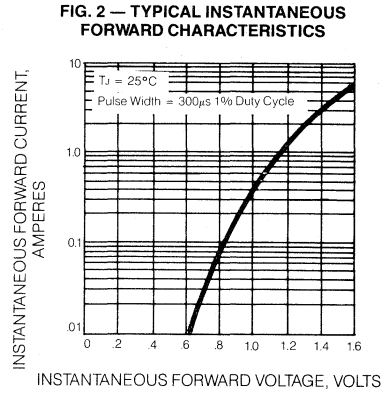
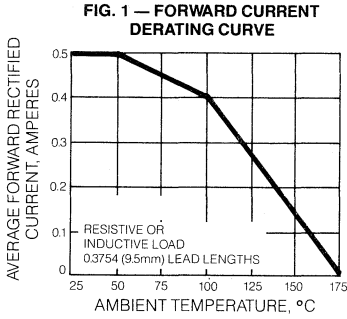

1N4933GP THRU 1N4937GP

MINIATURE GLASS PASSIVATED JUNCTION FAST SWITCHING PLASTIC RECTIFIER

Voltage - 50 to 600 Volts Current - 1.0 Ampere

FEATURES

- ◆ High temperature metallurgically bonded constructed rectifiers
- ◆ For use in high frequency rectifier circuits
- ◆ Plastic package has Underwriters Laboratory Flammability Classification 94V-0
- ◆ Fast switching for high efficiency
- ◆ Glass passivated cavity-free junction in D0-41 package
- ◆ 1.0 Ampere operation at $T_A = 75^\circ\text{C}$ with no thermal runaway
- ◆ Typical I_R less than $0.1 \mu\text{A}$
- ◆ Capable of meeting environmental standards of MIL-S-19500
- ◆ High temperature soldering guaranteed: $350^\circ\text{C}/10$ seconds/.375", (9.5mm) lead length at 5 lbs., (2.3kg) tension

PATENTED*

DO-41

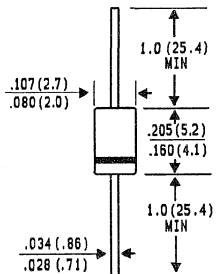

Dimensions in inches and (millimeters)

* Glass-plastic encapsulation technique is covered by Patent No. 3,996,602 of 1976; brazed-lead assembly to Patent No. 3,930,306 of 1976 and glass composition by Patent No. 3,752,701 of 1973



MECHANICAL DATA

Case: Molded plastic over glass
Terminals: Plated Axial leads, solderable per MIL-STD-202, Method 208
Polarity: Color band denotes cathode
Mounting Position: Any
Weight: 0.012 ounce, 0.3 gram

MAXIMUM RATINGS AND ELECTRICAL CHARACTERISTICS

Ratings at 25°C ambient temperature unless otherwise specified. Resistive or inductive load. For capacitive load, derate current by 20%.

SYMBOLS	1N					UNITS	
	4933GP	4934GP	4935GP	4936GP	4937GP		
* Maximum Recurrent Peak Reverse Voltage	V_{RRM}	50	100	200	400	600	Volts
* Maximum RMS Voltage	V_{RMS}	35	70	140	280	420	Volts
* Maximum DC Blocking Voltage	V_{DC}	50	100	200	400	600	Volts
* Maximum Average Forward Rectified Current .375", (9.5mm) Lead Lengths at $T_A = 75^\circ\text{C}$	$I_{(AV)}$	1.0					Amps
* Peak Forward Surge Current 8.3ms single half sine-wave superimposed on rated load (JEDEC Method)	I_{FSM}	30.0					Amps
* Maximum Instantaneous Forward Voltage at 1.0A	V_F	1.2					Volts
* Maximum DC Reverse Current $T_A = 25^\circ\text{C}$ at Rated DC Blocking Voltage $T_A = 125^\circ\text{C}$	I_R	100					μA
* Maximum Reverse Recovery Time (Note 1) $T_J = 25^\circ\text{C}$	T_{RR}	200					nS
Typical Junction Capacitance (Note 2)	C_J	15.0					pf
Typical Thermal Resistance (Note 3)	$R_{\theta JA}$	50.0					$^\circ\text{C}/\text{W}$
* Operating and Storage Temperature Range	T_J, T_{STG}	-65 to +175					$^\circ\text{C}$

NOTES: 1. Reverse Recovery Test Conditions : $I_F = 1.0\text{A}$, $V_R = 30$ Volts.
 2. Measured at 1.0 MHz and applied reverse voltage of 4.0 Volts.
 3. Thermal Resistance from Junction to Ambient at .375" (9.5mm) Lead Lengths, P.C. Board Mounted
 *JEDEC Registered Values.

RATINGS AND CHARACTERISTIC CURVES 1N4933GP THRU 1N4937GP

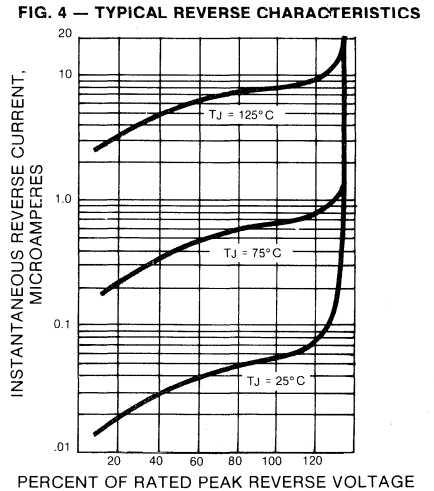
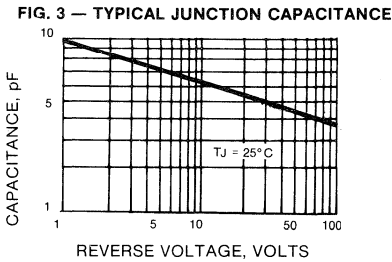
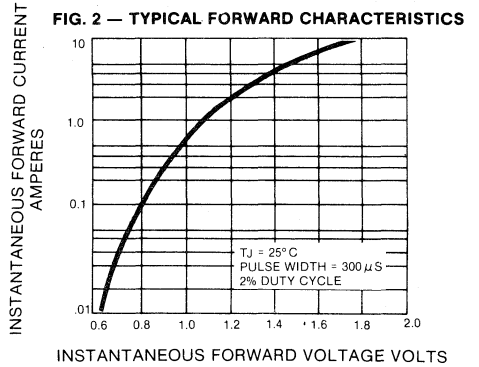
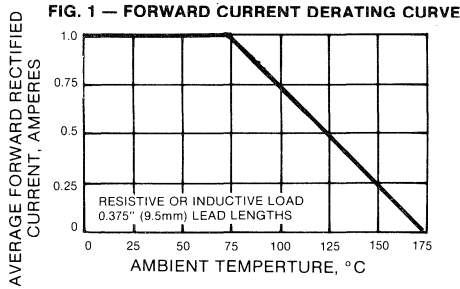

FIG. 5 — REVERSE RECOVERY TIME CHARACTERISTIC AND TEST CIRCUIT DIAGRAM

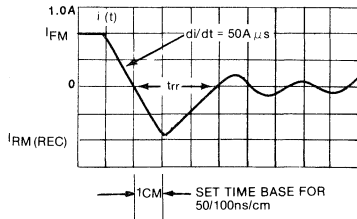
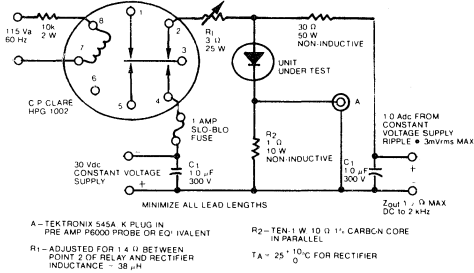
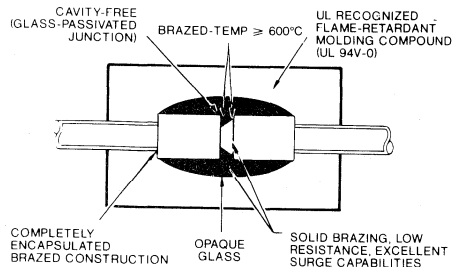

FIG. 6 — SUPERRECTIFIER



1N4942GP THRU 1N4948GP

MINIATURE GLASS PASSIVATED JUNCTION FAST SWITCHING PLASTIC RECTIFIER

Voltage - 200 to 1000 Volts Current - 1.0 Ampere

FEATURES

PATENTED*

D0-41

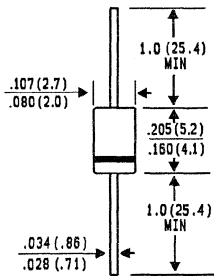

Dimensions in inches and (millimeters)

- ◆ High temperature metallurgically bonded constructed rectifiers
- ◆ For use in high frequency rectifier circuits
- ◆ Plastic package has Underwriters Laboratory Flammability Classification 94V-0
- ◆ Fast switching for high efficiency
- ◆ Glass passivated cavity-free junction in D0-41 package
- ◆ 1.0 Ampere operation at $T_A = 55^\circ\text{C}$ with no thermal runaway
- ◆ Capable of meeting environmental standards of MIL-S-19500
- ◆ High temperature soldering guaranteed $350^\circ\text{C}/10$ seconds/.375", (9.5mm) lead length at 5 lbs., (2.3kg) tension

MECHANICAL DATA

* Glass-plastic encapsulation technique is covered by Patent No. 3,996,602 of 1976; brazed-lead assembly to Patent No. 3,930,306 of 1976 and glass composition by Patent No. 3,752,701 of 1973



Case: Molded plastic over glass
Terminals: Plated Axial leads, solderable per MIL-STD-202, Method 208
Polarity: Color band denotes cathode
Mounting Position: Any
Weight: 0.012 ounce, 0.3 gram

MAXIMUM RATINGS AND ELECTRICAL CHARACTERISTICS

Ratings at 25°C ambient temperature unless otherwise specified. Resistive or inductive load. For capacitive load, derate current by 20%.

	SYMBOLS	1N 4942GP	1N 4944GP	1N 4946GP	1N 4947GP	1N 4948GP	UNITS
* Maximum Recurrent Peak Reverse Voltage	V_{RRM}	200	400	600	800	1000	Volts
* Maximum RMS Voltage	V_{RMS}	140	280	420	560	700	Volts
* Maximum DC Blocking Voltage	V_{DC}	200	400	600	800	1000	Volts
* Maximum Average Forward Rectified Current .375", (9.5mm) Lead Lengths at $T_A = 55^\circ\text{C}$	$I_{(AV)}$	1.0					Amps
* Peak Forward Surge Current 8.3ms single half sine-wave superimposed on rated load (JEDEC Method)	I_{FSM}	25.0					Amps
* Maximum Instantaneous Forward Voltage at 1.0A	V_F	1.3					Volts
* Maximum DC Reverse Current $T_A = 25^\circ\text{C}$ at Rated DC Blocking Voltage $T_A = 150^\circ\text{C}$	I_R	1.0 200					μA
* Maximum Reverse Recovery Time (Note 1) $T_J = 25^\circ\text{C}$	T_{RR}	150	150	250	250	500	nS
Typical Junction Capacitance (Note 2)	C_J	15.0					pf
Typical Thermal Resistance (Note 3)	$R_{\theta JA}$	50.0					$^\circ\text{C}/\text{W}$
* Operating and Storage Temperature Range	T_J, T_{STG}	-65 to +175					$^\circ\text{C}$

NOTES:

- Reverse Recovery Test Conditions : $I_F = 0.5\text{A}$, $I_R = 1.0\text{A}$, $I_{rr} = 0.25\text{A}$.
 - Measured at 1.0 MHz and applied reverse voltage of 4.0 Volts.
 - Thermal Resistance from Junction to Ambient at .375" (9.5mm) Lead Lengths, P.C. Board Mounted.
- * JEDEC registered values

RATINGS AND CHARACTERISTIC CURVES 1N4942GP THRU 1N4948GP

FIG. 1 — FORWARD CURRENT DERATING CURVE

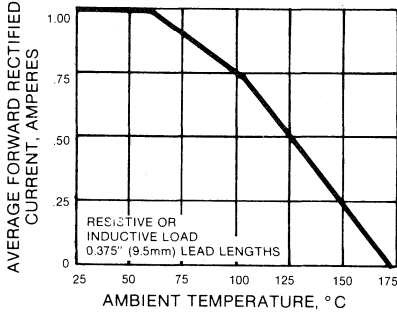

FIG. 2 — MAXIMUM NON-REPETITIVE PEAK SURGE CURRENT

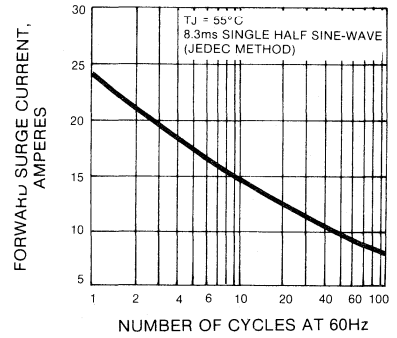

FIG. 3 — TYPICAL INSTANTANEOUS FORWARD CHARACTERISTICS

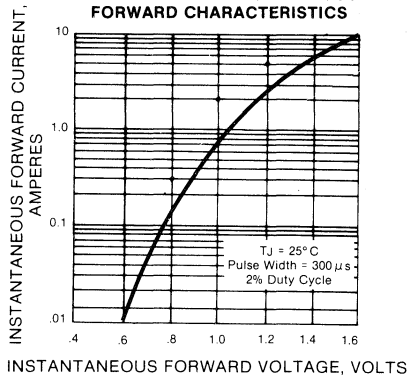

FIG. 4 — TYPICAL JUNCTION CAPACITANCE

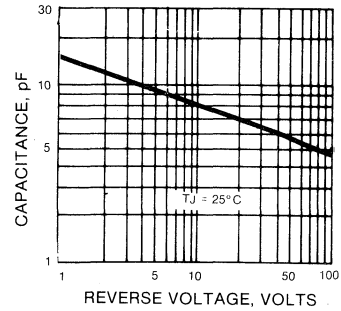

FIG. 5 — REVERSE RECOVERY TIME CHARACTERISTIC AND TEST CIRCUIT DIAGRAM

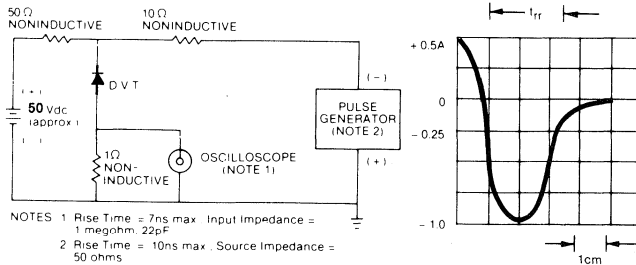
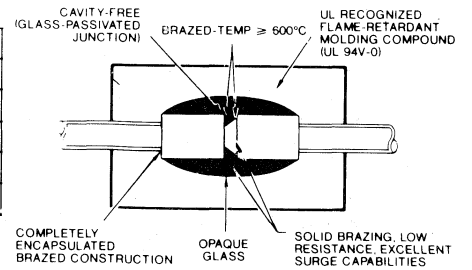

FIG. 6 — SUPERRECTIFIER



RGP10A THRU RGP10M

MINIATURE GLASS PASSIVATED JUNCTION PLASTIC FAST SWITCHING PLASTIC RECTIFIER

Voltage - 50 to 1000 Volts **Current** - 1.0 Ampere

FEATURES

- ◆ High temperature metallurgically bonded constructed rectifiers
- ◆ For use in high frequency rectifier circuits
- ◆ Plastic package has Underwriters Laboratory Flammability Classification 94V-0
- ◆ Fast switching for high efficiency
- ◆ Glass passivated cavity-free junction in D0-41 package
- ◆ 1.0 Ampere operation at $T_A = 55^\circ\text{C}$ with no thermal runaway
- ◆ Typical I_R less than $0.1 \mu\text{A}$
- ◆ Capable of meeting environmental standards of MIL-S-19500
- ◆ High temperature soldering guaranteed $350^\circ\text{C}/10$ seconds/.375", (9.5mm) lead length at 5 lbs., (2.3kg) tension

PATENTED*

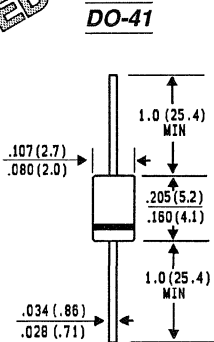

Dimensions in inches and (millimeters)

* Glass-plastic encapsulation technique is covered by Patent No. 3,996,602 of 1976; brazed-lead assembly to Patent No. 3,930,306 of 1976 and glass composition by Patent No. 3,752,701 of 1973



MECHANICAL DATA

- Case:** Molded plastic over glass
Terminals: Plated Axial leads, solderable per MIL-STD-202, Method 208
Polarity: Color band denotes cathode
Mounting Position: Any
Weight: 0.012 ounce, 0.3 gram

MAXIMUM RATINGS AND ELECTRICAL CHARACTERISTICS

Ratings at 25°C ambient temperature unless otherwise specified. Resistive or inductive load. For capacitive load, derate current by 20%.

	SYMBOLS	RGP	RGP	RGP	RGP	RGP	RGP	RGP	UNITS
		10A	10B	10D	10G	10J	10K	10M	
Maximum Recurrent Peak Reverse Voltage	V_{RRM}	50	100	200	400	600	800	1000	Volts
Maximum RMS Voltage	V_{RMS}	35	70	140	280	420	560	700	Volts
Maximum DC Blocking Voltage	V_{DC}	50	100	200	400	600	800	1000	Volts
Maximum Average Forward Rectified Current .375", (9.5mm) Lead Lengths at $T_A = 55^\circ\text{C}$	$I_{(AV)}$	1.0							Amps
Peak Forward Surge Current 8.3ms single half sine-wave superimposed on rated load (JEDEC Method)	I_{FSM}	30.0							Amps
Maximum Instantaneous Forward Voltage at 1.0A	V_F	1.3							Volts
Maximum Full Load Reverse Current, Full Cycle Average .375", (9.5mm) Lead Length $T_A = 55^\circ\text{C}$	$I_{R(AV)}$	100							μA
Maximum DC Reverse Current $T_A = 25^\circ\text{C}$ at Rated DC Blocking Voltage $T_A = 150^\circ\text{C}$	I_R	200							μA
Maximum Reverse Recovery Time (Note 1) $T_J = 25^\circ\text{C}$	T_{RR}	150	150	150	150	250	500	500	nS
Typical Junction Capacitance (Note 2)	C_J	15.0							pf
Typical Thermal Resistance (Note 3)	$R_{\theta JA}$	50.0							$^\circ\text{C}/\text{W}$
Operating and Storage Temperature Range	T_J, T_{STG}	-65 to +175							$^\circ\text{C}$

- NOTES: 1. Reverse Recovery Test Conditions : $I_F = 0.5\text{A}$, $I_R = 1.0\text{A}$, recover to 0.25A.
 2. Measured at 1.0 MHz and applied reverse voltage of 4.0 Volts.
 3. Thermal Resistance from Junction to Ambient at .375" (9.5mm) Lead Lengths, P.C. Board Mounted. -316-

RATINGS AND CHARACTERISTIC CURVES RGP10A THRU RGP10M

FIG. 1—REVERSE RECOVERY TIME CHARACTERISTIC AND TEST CIRCUIT DIAGRAM

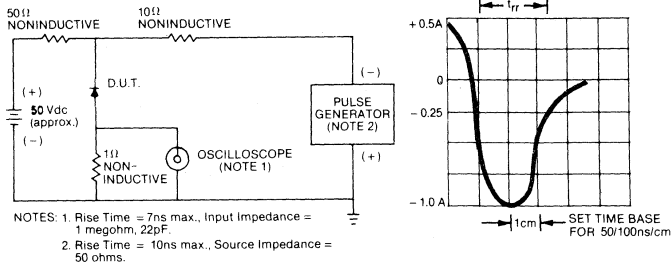

FIG. 2—TYPICAL JUNCTION CAPACITANCE

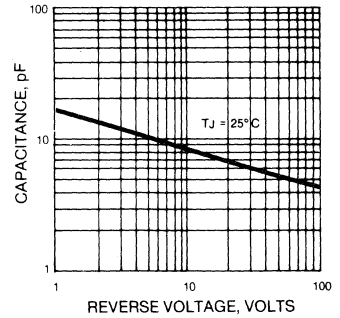

FIG. 3—FORWARD CURRENT DERATING CURVE

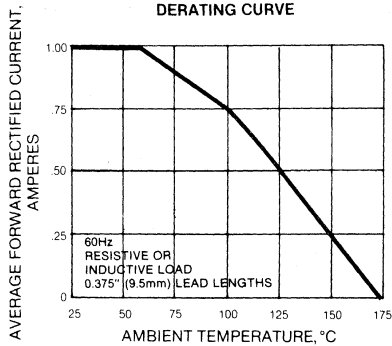

FIG. 4—TYPICAL INSTANTANEOUS FORWARD CHARACTERISTICS

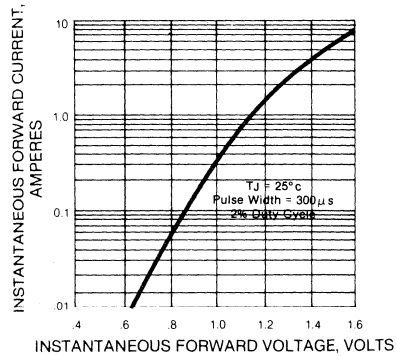

FIG. 5—MAXIMUM NON-REPETITIVE PEAK FORWARD SURGE CURRENT

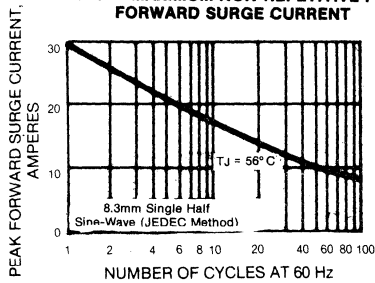
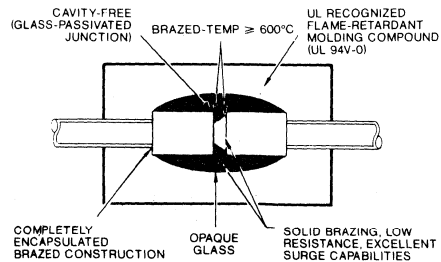

FIG. 6—SUPERRECTIFIER



1N5615GP THRU 1N5623GP

MINIATURE GLASS PASSIVATED JUNCTION FAST SWITCHING RECTIFIER

Voltage - 200 to 1000 Volts Current - 1.0 Ampere

FEATURES

PATENTED*

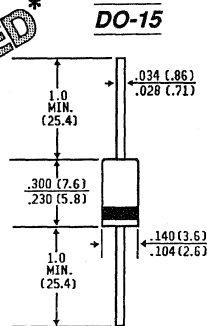

Dimensions in inches and (millimeters)

* Glass-plastic encapsulation technique is covered by Patent No. 3,996,602 of 1976; brazed-lead assembly to Patent No. 3,930,306 of 1976 and glass composition by Patent No. 3,752,701 of 1973

- ◆ High temperature metallurgically bonded constructed rectifiers
- ◆ Plastic package has Underwriters Laboratory Flammability Classification 94V-0
- ◆ Fast switching for high efficiency
- ◆ Glass passivated cavity-free junction
- ◆ 1.0 Ampere operation at $T_A = 55^\circ\text{C}$ with no thermal runaway
- ◆ Capable of meeting environmental standards of MIL-S-19500
- ◆ High temperature soldering guaranteed $350^\circ\text{C}/10$ seconds/.375", (9.5mm) lead length at 5 lbs., (2.3kg) tension

MECHANICAL DATA

Case: Molded plastic over glass
Terminals: Axial leads, solderable per MIL-STD-202, Method 208
Polarity: Color band denotes cathode
Mounting Position: Any
Weight: 0.015 ounce, .4 gram



MAXIMUM RATINGS AND ELECTRICAL CHARACTERISTICS

Ratings at 25°C ambient temperature unless otherwise specified. Resistive or inductive load. For capacitive load, derate current by 20%.

SYMBOLS	1N	1N	1N	1N	1N	UNITS	
	5615GP	5617GP	5619GP	5621GP	5623GP		
* Maximum Recurrent Peak Reverse Voltage	V_{RRM}	200	400	600	800	1000	Volts
* Maximum RMS Voltage	V_{RMS}	140	280	420	560	700	Volts
* Maximum DC Blocking Voltage	V_{DC}	200	400	600	800	1000	Volts
* Maximum Average Forward Rectified Current .375", (9.5mm) Lead Lengths at $T_A = 55^\circ\text{C}$	$I_{(AV)}$	1.0					Amps
* Peak Forward Surge Current 8.3ms single half sine-wave superimposed on rated load (JEDEC Method)	I_{FSM}	50.0					Amps
Maximum Instantaneous Forward Voltage at 1.0A	V_F	1.2					Volts
Maximum DC Reverse Current $T_A = 25^\circ\text{C}$ at Rated DC Blocking Voltage $T_A = 100^\circ\text{C}$	I_R	0.5 25.0					μA
* Maximum Reverse Recovery Time (Note 1) $T_J = 25^\circ\text{C}$	T_{RR}	150	150	250	300	500	nS
Typical Junction Capacitance (Note 2)	C_J	25.0					pf
Typical Thermal Resistance (Note 3)	$R_{\theta JA}$	30.0					$^\circ\text{C}/\text{W}$
* Operating and Storage Temperature Range	T_J, T_{STG}	-65 to +175					$^\circ\text{C}$

NOTES:

- Reverse Recovery Test Conditions : $I_F = 0.5\text{A}$, $I_R = 1.0\text{A}$, $I_{rr} = 0.25\text{A}$.
 - Measured at 1.0 MHz and applied reverse voltage of 4.0 Volts.
 - Thermal Resistance from Junction to Ambient at .375" (9.5mm) Lead Lengths, P.C. Board Mounted.
- * JEDEC registered values

RATINGS AND CHARACTERISTIC CURVES 1N5615GP THRU 1N5623GP

FIG. 1—REVERSE RECOVERY TIME CHARACTERISTIC AND TEST CIRCUIT DIAGRAM

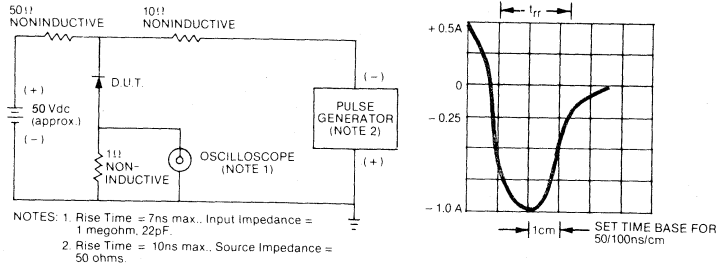

FIG. 2—TYPICAL INSTANTANEOUS FORWARD CHARACTERISTICS

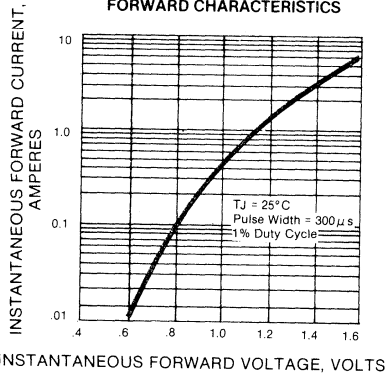

FIG. 3—FORWARD CURRENT DERATING CURVE

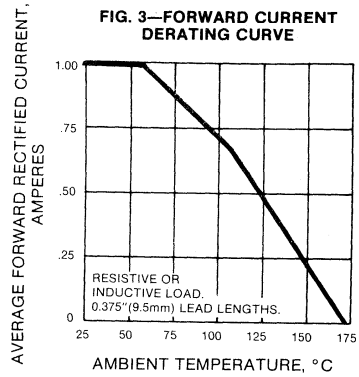

FIG. 4—TYPICAL JUNCTION CAPACITANCE

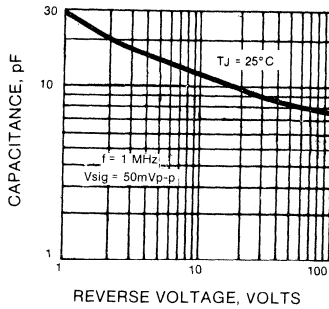
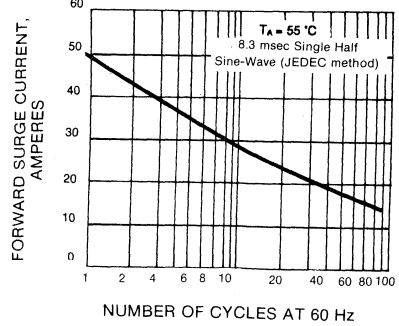

FIG. 5—PEAK FORWARD SURGE CURRENT



GI810 THRU GI818

MINIATURE GLASS PASSIVATED JUNCTION PLASTIC FAST SWITCHING RECTIFIER

Voltage - 50 to 1000 Volts Current - 1.0 Ampere

FEATURES

- ◆ High temperature metallurgically bonded constructed rectifiers
- ◆ Plastic package has Underwriters Laboratory Flammability Classification 94V-0
- ◆ Fast switching for high efficiency
- ◆ Glass passivated cavity-free junction in D0-15 package
- ◆ 1.0 Ampere operation at $T_A = 75^\circ\text{C}$ with no thermal runaway
- ◆ Typical I_R less than $0.1 \mu\text{A}$
- ◆ Capable of meeting environmental standards of MIL-S-19500
- ◆ High temperature soldering guaranteed: $350^\circ\text{C}/10 \text{ seconds}/.375"$, (9.5mm) lead length at 5 lbs., (2.3kg) tension

PATENTED*

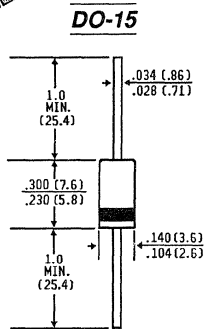

Dimensions in inches and (millimeters)

* Glass-plastic encapsulation technique is covered by Patent No. 3,996,602 of 1976; brazed-lead assembly to Patent No. 3,930,306 of 1976 and glass composition by Patent No. 3,752,701 of 1973



MECHANICAL DATA

Case: Molded plastic over glass
Terminals: Axial leads, solderable per MIL-STD-202, Method 208
Polarity: Color band denotes cathode
Mounting Position: Any
Weight: 0.015 ounce, 0.4 gram

MAXIMUM RATINGS AND ELECTRICAL CHARACTERISTICS

Ratings at 25°C ambient temperature unless otherwise specified. Resistive or inductive load. For capacitive load, derate current by 20%.

	SYMBOLS	GI 810	GI 811	GI 812	GI 814	GI 816	GI 817	GI 818	UNITS
Maximum Recurrent Peak Reverse Voltage	V_{RRM}	50	100	200	400	600	800	1000	Volts
Maximum RMS Voltage	V_{RMS}	35	70	140	280	420	560	700	Volts
Maximum DC Blocking Voltage	V_{DC}	50	100	200	400	600	800	1000	Volts
Maximum Average Forward Rectified Current .375", (9.5mm) Lead Lengths at $T_A = 75^\circ\text{C}$	$I_{(AV)}$	1.0							Amps
Peak Forward Surge Current 8.3ms single half sine-wave superimposed on rated load (JEDEC Method)	I_{FSM}	30.0							Amps
Maximum Instantaneous Forward Voltage at 1.0A	V_F	1.2							Volts
Maximum DC Reverse Current $T_A = 25^\circ\text{C}$ at Rated DC Blocking Voltage $T_A = 150^\circ\text{C}$	I_R	10.0 100							μA
Maximum Reverse Recovery Time (Note 1)	T_{RR}	750							ns
Typical Junction Capacitance (Note 2)	C_J	25.0							pf
Typical Thermal Resistance (Note 3)	$R_{\theta JA}$	30.0							$^\circ\text{C}/\text{W}$
Operating and Storage Temperature Range	T_J, T_{STG}	-65 to +175							$^\circ\text{C}$

NOTES: 1. Reverse Recovery Test Conditions : $I_F = 1.0\text{A}$, $V_R = 30\text{V}$.
 2. Measured at 1.0 MHz and applied reverse voltage of 4.0 Volts.
 3. Thermal Resistance from Junction to Ambient at .375" (9.5mm) Lead Lengths, P.C. Board Mounted.

RATINGS AND CHARACTERISTIC CURVES G1810 THRU G1818

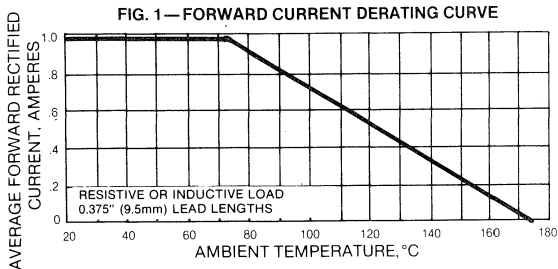

FIG. 3— TYPICAL JUNCTION CAPACITANCE

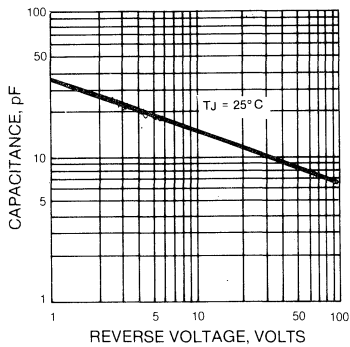

FIG. 5— REVERSE RECOVERY TIME CHARACTERISTIC AND TEST CIRCUIT DIAGRAM

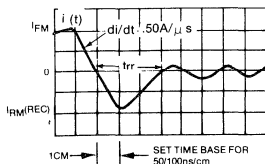
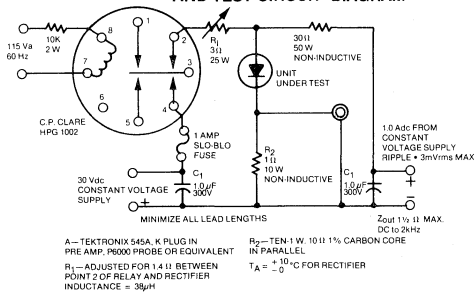

FIG. 2— TYPICAL INSTANTANEOUS FORWARD CHARACTERISTICS

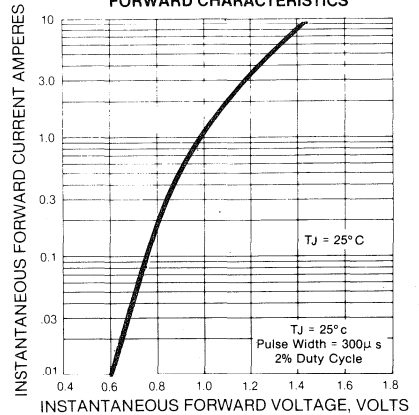

FIG. 4 — MAXIMUM NON-REPETITIVE PEAK FORWARD SURGE CURRENT

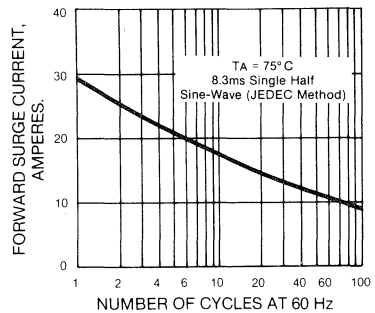
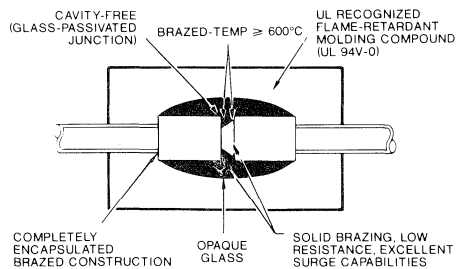

FIG. 6 — SUPERRECTIFIER



RGP15A THRU RGP15M

MINIATURE GLASS PASSIVATED JUNCTION PLASTIC FAST SWITCHING RECTIFIER

Voltage - 50 to 1000 Volts Current - 1.5 Amperes

FEATURES

PATENTED*

DO-15

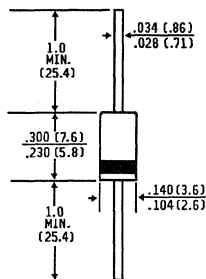

Dimensions in inches and (millimeters)

* Glass-plastic encapsulation technique is covered by Patent No. 3,996,602 of 1976; brazed -lead assembly to Patent No. 3,930,306 of 1976 and glass composition by Patent No. 3,752,701 of 1973

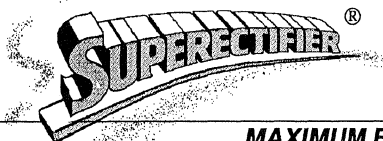

- ◆ High temperature metallurgically bonded constructed rectifiers
- ◆ Plastic package has Underwriters Laboratory Flammability Classification 94V-0
- ◆ Glass passivated cavity-free junction in DO-15 package
- ◆ 1.5 Ampere operation at $T_A = 55^\circ\text{C}$ with no thermal runaway
- ◆ Fast switching for high efficiency
- ◆ Typical I_R less than $0.1 \mu\text{A}$
- ◆ Capable of meeting environmental standards of MIL-S-19500
- ◆ High temperature soldering guaranteed $350^\circ\text{C}/10$ seconds/.375", (9.5mm) lead length at 5 lbs., (2.3kg) tension

MECHANICAL DATA

Case: Molded plastic over glass

Terminals: Plated Axial leads, solderable per MIL-STD-202, Method 208

Polarity: Color band denotes cathode

Mounting Position: Any

Weight: 0.015 ounce, 0.4 gram

MAXIMUM RATINGS AND ELECTRICAL CHARACTERISTICS

Ratings at 25°C ambient temperature unless otherwise specified. Resistive or inductive load. For capacitive load, derate current by 20%.

		RGP SYMBOLS	RGP 15A	RGP 15B	RGP 15D	RGP 15G	RGP 15J	RGP 15K	RGP 15M	UNITS
Maximum Recurrent Peak Reverse Voltage	V_{RRM}		50	100	200	400	600	800	1000	Volts
Maximum RMS Voltage	V_{RMS}		35	70	140	280	420	560	700	Volts
Maximum DC Blocking Voltage	V_{DC}		50	100	200	400	600	800	1000	Volts
Maximum Average Forward Rectified Current .375", (9.5mm) Lead Lengths at $T_A = 55^\circ\text{C}$	$I_{(AV)}$					1.5				Amps
Peak Forward Surge Current 8.3ms single half sine-wave superimposed on rated load (JEDEC Method)	I_{FSM}					50.0				Amps
Maximum Instantaneous Forward Voltage at 1.5A	V_F					1.3				Volts
Maximum DC Reverse Current $T_A = 25^\circ\text{C}$ at Rated DC Blocking Voltage $T_A = 150^\circ\text{C}$	I_R					5.0				μA
Maximum Full Load Reverse Current, Full Cycle Average .375", (9.5mm) Lead Length $T_A = 55^\circ\text{C}$	$I_{R(AV)}$					100				μA
Maximum Reverse Recovery Time (Note 2) $T_J = 25^\circ\text{C}$	T_{RR}		150	150	150	150	250	500	500	nS
Typical Junction Capacitance (Note 1)	C_J					25.0				pf
Typical Thermal Resistance (Note 3)	$R_{\theta JA}$					30.0				$^\circ\text{C}/\text{W}$
Operating and Storage Temperature Range	T_J, T_{STG}					-65 to +175				$^\circ\text{C}$

- NOTES:
1. Measured at 1.0 MHz and applied reverse voltage of 4.0 Volts.
 2. Reverse Recovery Test Conditions: $I_F = .5\text{A}$, $I_R = 1\text{A}$, $I_{rr} = .25\text{A}$.
 3. Thermal Resistance from Junction to Ambient at .375" (9.5mm) Lead Lengths, P.C. Board Mounted.

RATINGS AND CHARACTERISTIC CURVES RGP15A THRU RGP15M

FIG. 1 — REVERSE RECOVERY TIME CHARACTERISTIC AND TEST CIRCUIT DIAGRAM

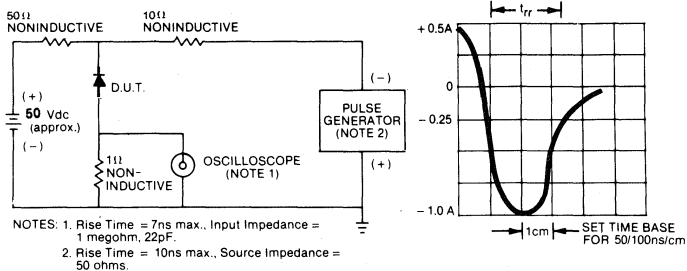

FIG. 2 — FORWARD CURRENT DERATING CURVE

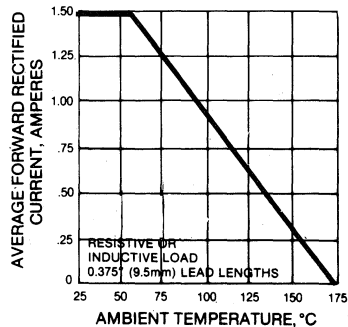

FIG. 3 — TYPICAL INSTANTANEOUS FORWARD CHARACTERISTICS

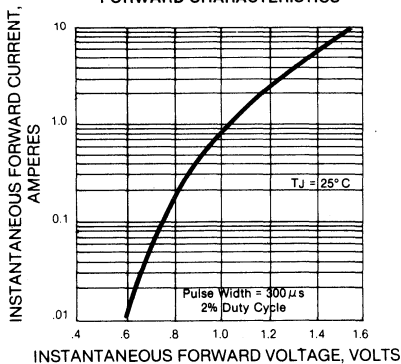

FIG. 4 — TYPICAL JUNCTION CAPACITANCE

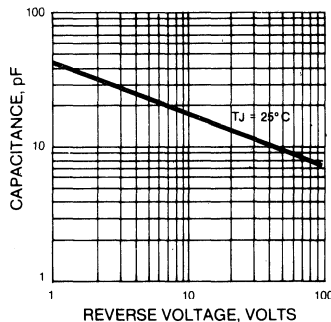

FIG. 5 — MAXIMUM NON-REPETITIVE PEAK FORWARD SURGE CURRENT

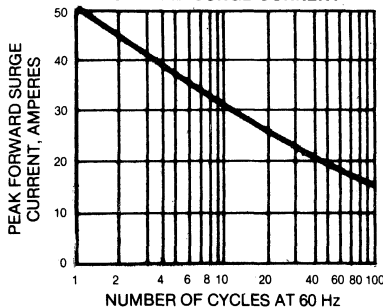
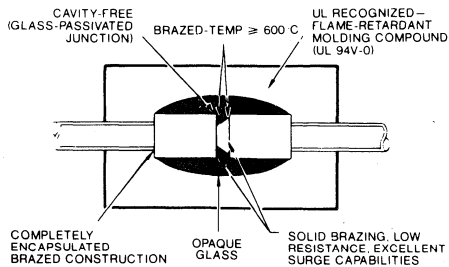

FIG. 6 — SUPERRECTIFIER



RGP20A THRU RGP20J

FAST SWITCHING GLASS PASSIVATED JUNCTION PLASTIC RECTIFIER

Voltage - 50 to 600 Volts Current - 2.0 Amperes

FEATURES

- ◆ High temperature metallurgically bonded constructed rectifiers
- ◆ Plastic package has Underwriters Laboratory Flammability Classification 94V-0
- ◆ Fast switching for high efficiency
- ◆ Glass passivated cavity-free junction
- ◆ 2.0 Ampere operation at $T_A = 55^\circ\text{C}$ with no thermal runaway
- ◆ Typical I_R less than $0.1 \mu\text{A}$
- ◆ Capable of meeting environmental standards of MIL-S-19500
- ◆ High temperature soldering guaranteed: $350^\circ\text{C}/10$ seconds/.375", (9.5mm) lead length at 5 lbs., (2.3kg) tension



PATENTED*

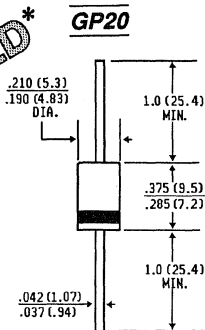

Dimensions in inches and (millimeters)

* Glass-plastic encapsulation technique is covered by Patent No. 3,996,602 of 1976; brazed-lead assembly to Patent No. 3,930,306 of 1976 and glass composition by Patent No. 3,752,701 of 1973

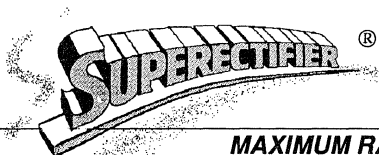

MECHANICAL DATA

Case: Molded plastic over glass
Terminals: Plated Axial leads, solderable per MIL-STD-202, Method 208
Polarity: Band denotes cathode
Mounting Position: Any
Weight: 0.03 ounce, 0.8 gram

MAXIMUM RATINGS AND ELECTRICAL CHARACTERISTICS

Ratings at 25°C ambient temperature unless otherwise specified. Resistive or inductive load. For capacitive load, derate current by 20%.

	SYMBOLS	RGP 20A	RGP 20B	RGP 20D	RGP 20G	RGP 20J	UNITS
Maximum Recurrent Peak Reverse Voltage	V_{RRM}	50	100	200	400	600	Volts
Maximum RMS Voltage	V_{RMS}	35	70	140	280	420	Volts
Maximum DC Blocking Voltage	V_{DC}	50	100	200	400	600	Volts
Maximum Average Forward Rectified Current .375", (9.5mm) Lead Lengths at $T_A = 55^\circ\text{C}$	$I_{(AV)}$	2.0					Amps
Peak Forward Surge Current 8.3ms single half sine-wave superimposed on rated load (JEDEC Method)	I_{FSM}	65.0					Amps
Maximum Instantaneous Forward Voltage at 2.0A	V_F	1.3					Volts
Maximum DC Reverse Current $T_A = 25^\circ\text{C}$ at Rated DC Blocking Voltage $T_A = 125^\circ\text{C}$	I_R	5.0 100					μA
Maximum Full Load Reverse Current, Full Cycle Average, .375" (9.5mm) Lead Length $T_A = 55^\circ\text{C}$	$I_{R(AV)}$	100					μA
Maximum Reverse Recovery Time (Note 2) $T_J = 25^\circ\text{C}$	T_{RR}	150				250	nS
Typical Junction Capacitance (Note 1)	C_J	35					pf
Typical Thermal Resistance (Note 3)	$R_{\theta JA}$	22.0					$^\circ\text{C}/\text{W}$
Operating and Storage Temperature Range	T_J, T_{STG}	-65 to +175					$^\circ\text{C}$

- NOTES: 1. Measured at 1 MHz and applied reverse voltage of 4.0 volts.
 2. Reverse Recovery Test Conditions: $I_F = 0.5\text{A}$, $I_R = 1.0\text{A}$, $I_{rr} = 0.25\text{A}$.
 3. Thermal Resistance from Junction to Ambient at .375" (9.5mm) Lead Lengths, P.C. Board Mounted.

RATINGS AND CHARACTERISTIC CURVES RGP20A THRU RGP20J

FIG. 1 — REVERSE RECOVERY TIME CHARACTERISTIC AND TEST CIRCUIT DIAGRAM

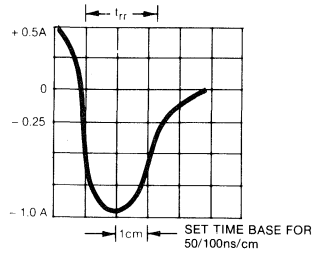
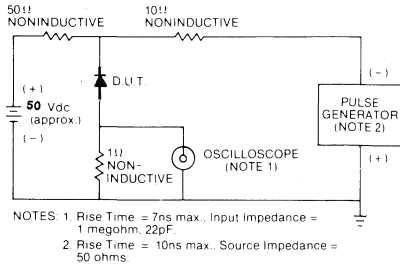

FIG. 3 — TYPICAL INSTANTANEOUS FORWARD CHARACTERISTICS

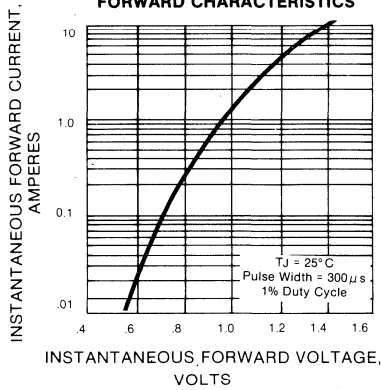

FIG. 2 — FORWARD CURRENT DERATING CURVE

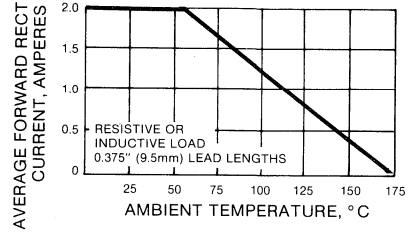

FIG. 4 — TYPICAL JUNCTION CAPACITANCE

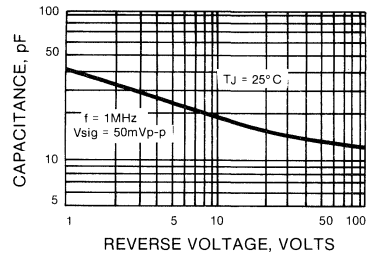

FIG. 5 — MAXIMUM NON-REPETITIVE PEAK FORWARD SURGE CURRENT

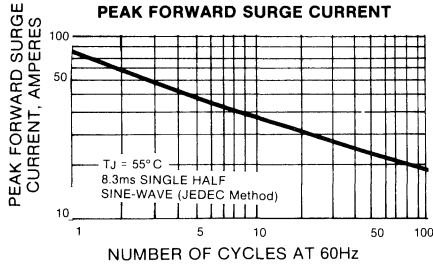
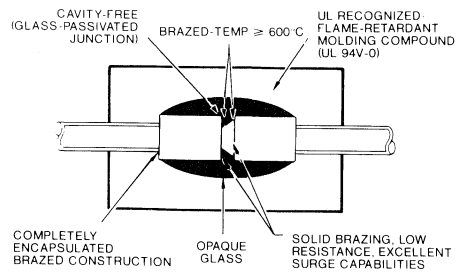

FIG. 6 — SUPERRECTIFIER



RGP25A THRU RGP25M

GLASS PASSIVATED JUNCTION FAST SWITCHING PLASTIC RECTIFIER

Voltage - 50 to 1000 Volts Current -2.5 Amperes

FEATURES

PATENTED* **DO-201AD**

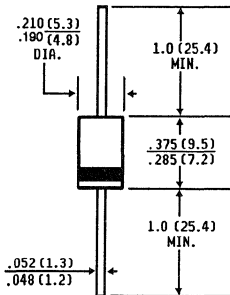

Dimensions in inches and (millimeters)

* Glass-plastic encapsulation technique is covered by Patent No. 3,996,602 of 1976; brazed-lead assembly to Patent No. 3,930,306 of 1976 and glass composition by Patent No. 3,752,701 of 1973

- ◆ High temperature metallurgically bonded constructed rectifiers
- ◆ Plastic package has Underwriters Laboratory Flammability Classification 94V-0
- ◆ Glass passivated cavity-free junction in DO-201AD package
- ◆ 2.5 Ampere operation at $T_A = 55^\circ\text{C}$ with no thermal runaway
- ◆ Typical I_R less than $0.1 \mu\text{A}$
- ◆ Capable of meeting environmental standards of MIL-S-19500
- ◆ Fast switching for high efficiency
- ◆ High temperature soldering guaranteed $350^\circ\text{C}/10$ seconds/.375", (9.5mm) lead length at 5 lbs., (2.3kg) tension

MECHANICAL DATA

Case: Molded plastic over glass

Terminals: Plated Axial leads, solderable per MIL-STD-202, Method 208

Polarity: Color band denotes cathode

Mounting Position: Any

Weight: 0.04 ounce, 1.12 grams



MAXIMUM RATINGS AND ELECTRICAL CHARACTERISTICS

Ratings at 25°C ambient temperature unless otherwise specified. Resistive or inductive load. For capacitive load, derate current by 20%.

	SYMBOLS	RGP 25A	RGP 25B	RGP 25D	RGP 25G	RGP 25J	RGP 25K	RGP 25M	UNITS
Maximum Recurrent Peak Reverse Voltage	V_{RRM}	50	100	200	400	600	800	1000	Volts
Maximum RMS Voltage	V_{RMS}	35	70	140	280	420	560	700	Volts
Maximum DC Blocking Voltage	V_{DC}	50	100	200	400	600	800	1000	Volts
Maximum Average Forward Rectified Current .375", (9.5mm) Lead Lengths at $T_A = 55^\circ\text{C}$	$I_{(AV)}$	2.5							Amps
Peak Forward Surge Current 8.3ms single half sine-wave superimposed on rated load (JEDEC Method)	I_{FSM}	100							Amps
Maximum Instantaneous Forward Voltage at 2.5A	V_F	1.3							Volts
Maximum DC Reverse Current $T_A = 25^\circ\text{C}$ at Rated DC Blocking Voltage $T_A = 125^\circ\text{C}$	I_R	200							μA
Maximum Full Load Reverse Current, Full Cycle Average .375", (9.5mm) Lead Length $T_A = 55^\circ\text{C}$	$I_{R(AV)}$	100							μA
Maximum Reverse Recovery Time (Note 2) $T_J = 25^\circ\text{C}$	T_{RR}	150	150	150	150	250	500	500	ns
Typical Junction Capacitance (Note 1)	C_J	60.0							pf
Typical Thermal Resistance (Note 3)	$R_{\theta JA}$	16.0							$^\circ\text{C}/\text{W}$
Operating and Storage Temperature Range	T_J, T_{STG}	-65 to +175							$^\circ\text{C}$

- NOTES:
1. Measured at 1.0 MHz and applied reverse voltage of 4.0 Volts.
 2. Reverse Recovery Test Conditions: $I_F = 0.5\text{A}$, $I_R = 1.0\text{A}$, $I_{rr} = .25\text{A}$.
 3. Thermal Resistance from Junction to Ambient at .375" (9.5mm) Lead Lengths, P.C. Board Mounted.

RATINGS AND CHARACTERISTIC CURVES RGP25A THRU RGP25M

FIG. 1 — REVERSE RECOVERY TIME CHARACTERISTIC AND TEST CIRCUIT DIAGRAM

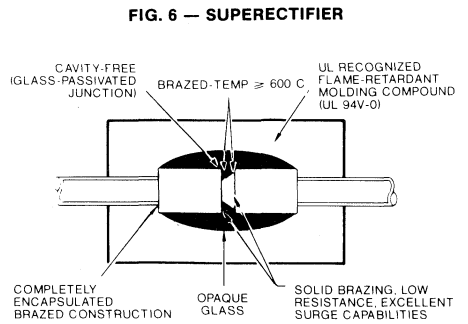
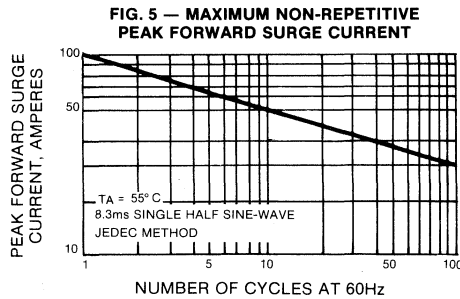
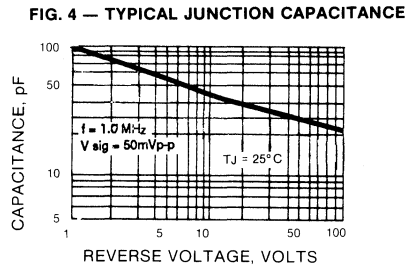
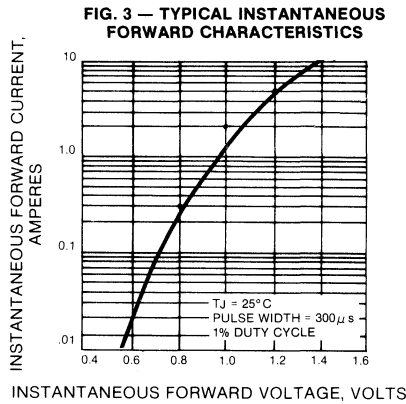
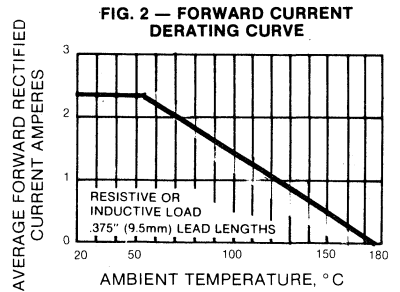
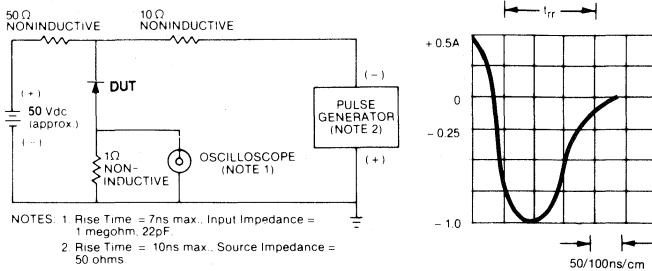

RGP30A THRU RGP30M

GLASS PASSIVATED JUNCTION FAST SWITCHING PLASTIC RECTIFIER

Voltage^a - 50 to 1000 Volts Current - 3.0 Amperes

FEATURES

- ◆ High temperature metallurgically bonded constructed rectifiers
- ◆ Plastic package has Underwriters Laboratory Flammability Classification 94V-0
- ◆ Glass passivated cavity-free junction in DO-201AD package
- ◆ 3.0 Ampere operation at $T_A = 55^\circ\text{C}$ with no thermal runaway
- ◆ Typical I_R less than $0.1 \mu\text{A}$
- ◆ Capable of meeting environmental standards of MIL-S-19500
- ◆ Fast switching for high efficiency
- ◆ High temperature soldering guaranteed: $350^\circ\text{C}/10$ seconds/.375", (9.5mm) lead length at 5 lbs., (2.3kg) tension

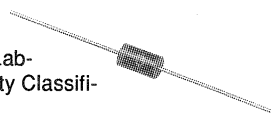

PATENTED*

DO-201AD

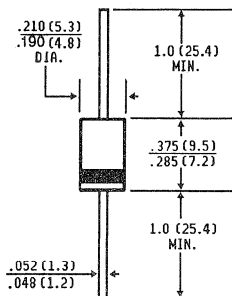

Dimensions in inches and (millimeters)

* Glass-plastic encapsulation technique is covered by Patent No. 3,996,602 of 1976; brazed-lead assembly to Patent No. 3,930,306 of 1976 and glass composition by Patent No. 3,752,701 of 1973



MECHANICAL DATA

- Case:** Molded plastic over glass
Terminals: Axial leads, solderable per MIL-STD-202, Method 208
Polarity: Color band denotes cathode
Mounting Position: Any
Weight: 0.04 ounce, 1.12 grams

MAXIMUM RATINGS AND ELECTRICAL CHARACTERISTICS

Ratings at 25°C ambient temperature unless otherwise specified. Resistive or inductive load. For capacitive load, derate current by 20%.

		RGP SYMBOLS	RGP 30A	RGP 30B	RGP 30D	RGP 30G	RGP 30J	RGP 30K	RGP 30M	UNITS
Maximum Recurrent Peak Reverse Voltage	V_{RRM}	50	100	200	400	600	800	1000		Volts
Maximum RMS Voltage	V_{RMS}	35	70	140	280	420	560	700		Volts
Maximum DC Blocking Voltage	V_{DC}	50	100	200	400	600	800	1000		Volts
Maximum Average Forward Rectified Current .375", (9.5mm) Lead Lengths at $T_A = 55^\circ\text{C}$	$I_{(AV)}$				3.0					Amps
Peak Forward Surge Current 8.3ms single half sine-wave superimposed on rated load (JEDEC Method)	I_{FSM}				125					Amps
Maximum Instantaneous Forward Voltage at 3.0A	V_F				1.3					Volts
Maximum DC Reverse Current $T_A = 25^\circ\text{C}$ at Rated DC Blocking Voltage $T_A = 125^\circ\text{C}$	I_R				5.0					μA
Maximum Full Load Reverse Current, Full Cycle Average .375", (9.5mm) Lead Length $T_A = 55^\circ\text{C}$	$I_{R(AV)}$				100					μA
Maximum Reverse Recovery Time (Note 2) $T_J = 25^\circ\text{C}$	T_{RR}	150	150	150	150	250	500	500		ns
Typical Junction Capacitance (Note 1)	C_J				60.0					pf
Typical Thermal Resistance (Note 3)	$R_{\theta JA}$				16.0					$^\circ\text{C}/\text{W}$
Operating and Storage Temperature Range	T_J, T_{STG}				-65 to +175					$^\circ\text{C}$

- NOTES: 1. Measured at 1.0 MHz and applied reverse voltage of 4.0 Volts.
 2. Reverse Recovery Test Conditions: $I_F = 0.5\text{A}$, $I_R = 1.0\text{A}$, $I_{rr} = .25\text{A}$.
 3. Thermal Resistance from Junction to Ambient at .375" (9.5mm) Lead Lengths, P.C. Board Mounted.

RATINGS AND CHARACTERISTIC CURVES RGP30A THRU RGP30M

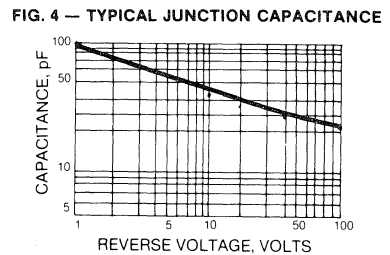
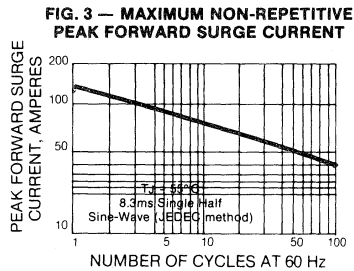
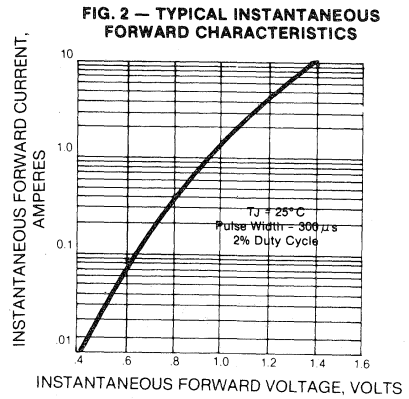
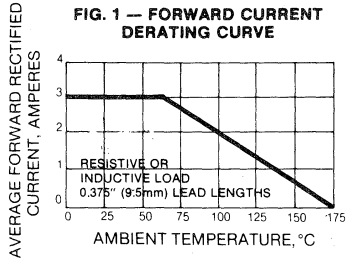
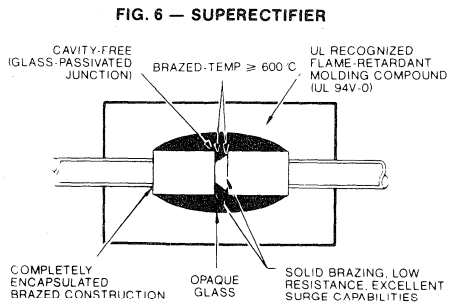
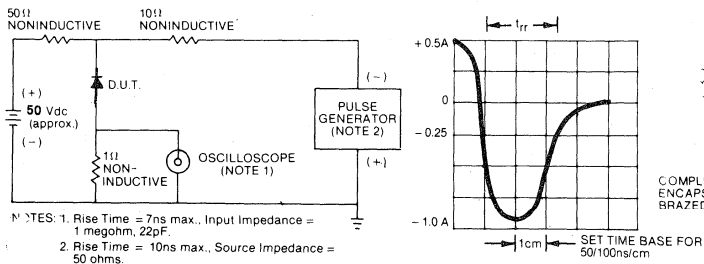

FIG. 5 — REVERSE RECOVERY TIME CHARACTERISTIC AND TEST CIRCUIT DIAGRAM



**MINIATURE GLASS
PASSIVATED CHIP
PLASTIC RECTIFIER**

***1.0 AMPERE
50 VOLTS TO 1000 VOLTS***

**GENERAL
INSTRUMENT**

MPG06A THRU MPG06M

MINIATURE GLASS PASSIVATED JUNCTION PLASTIC SILICON RECTIFIER

Voltage - 50 to 1000 Volts Current- 1.0 Ampere

FEATURES

- ◆ Plastic package has Underwriters Laboratory Flammability Classification 94 V-0
- ◆ Low forward voltage, high current capability
- ◆ Glass passivated chip
- ◆ High Surge Capability
- ◆ 1.0 Ampere operation at $T_A = 25^\circ\text{C}$ with no thermal runaway
- ◆ Typical I_R less than $0.1 \mu\text{A}$
- ◆ High temperature soldering guaranteed :250°C/10 seconds/.375", (9.5mm) lead length at 5 lbs., (2.3kg) tension

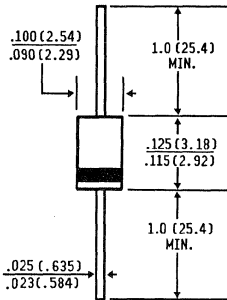

Dimensions in inches
and
(millimeters)

MECHANICAL DATA

Case: Molded plastic over glass passivated chip

Terminals: Plated Axial leads, solderable per MIL-STD-202, Method 208

Polarity: Color band denotes cathode

Mounting Position: Any

Weight: 0.0064 ounce, .181 grams

MAXIMUM RATINGS AND ELECTRICAL CHARACTERISTICS

Ratings at 25°C ambient temperature unless otherwise specified.
Single phase, half wave, 60Hz, resistive or inductive load.

	SYMBOLS	MPG	MPG	MPG	MPG	MPG	MPG	MPG	UNITS
		06A	06B	06D	06G	06J	06K	06M	
Maximum Recurrent Peak Reverse Voltage	V_{RRM}	50	100	200	400	600	800	1000	Volts
Maximum RMS Voltage	V_{RMS}	35	70	140	280	420	560	700	Volts
Maximum DC Blocking Voltage	V_{DC}	50	170	200	400	600	800	1000	Volts
Maximum Average Forward Rectified Current, .375" (9.5mm) Lead Length at $T_A = 25^\circ\text{C}$	$I_{(AV)}$	1.0							Amps
Peak Forward Surge Current 8.3ms single half sine-wave superimposed on rated load (JEDEC Method) $T_A = 25^\circ\text{C}$	I_{FSM}	40.0							Amps
Maximum Instantaneous Forward Voltage at 1.0A	V_F	1.1							Volts
Maximum DC Reverse Current $T_A = 25^\circ\text{C}$ at Rated DC Blocking Voltage $T_A = 125^\circ\text{C}$	I_R	50.0							μA
Typical Junction Capacitance (Note 1)	C_J	10.0							pf
Typical Reverse Recovery Time (Note 2)	T_{RR}	0.6							μs
Thermal Resistance Typical Maximum (Note 3)	$R_{\theta JA}$	65.0 85.0							$^\circ\text{C}/\text{W}$
Operating and Storage Temperature Range	T_J, T_{STG}	-50 to +150							$^\circ\text{C}$

NOTES:

1. Measured at 1.0 MHz and applied reverse voltage of 4.0 Volts.
2. Reverse Recovery Test Conditions: $I_F = 0.5\text{A}$, $I_R = 1.0\text{A}$, $I_{rr} = 0.25\text{A}$.
3. Thermal Resistance from Junction to Ambient at .375" (9.5mm) Lead Lengths, P.C. Board Mounted.

RATINGS AND CHARACTERISTIC CURVES MPG06A THRU MPG06M

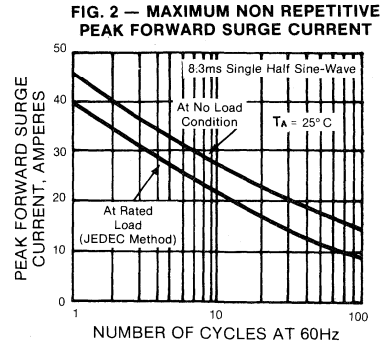
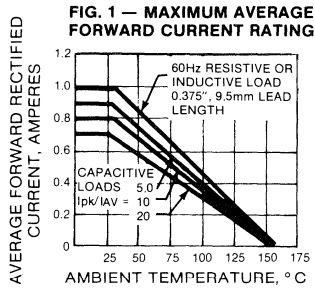

FIG. 3 — TYPICAL FORWARD CHARACTERISTICS

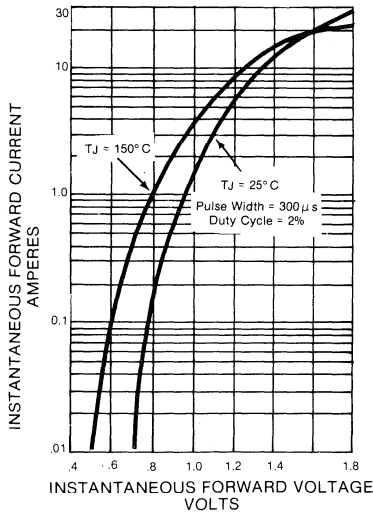
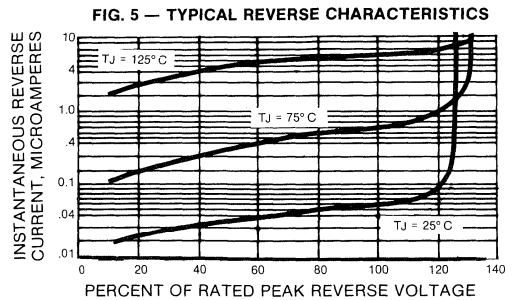
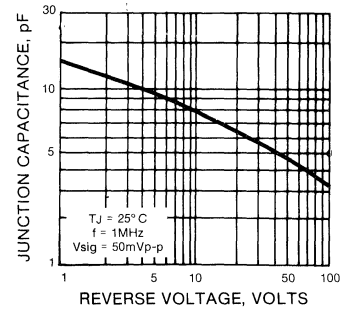

FIG. 4 — TYPICAL JUNCTION CAPACITANCE



RMPG06A THRU RMPG06J

MINIATURE GLASS PASSIVATED JUNCTION FAST SWITCHING PLASTIC SILICON RECTIFIER

Voltage - 50 to 600 Volts Current- 1.0 Ampere

FEATURES

- ◆ Plastic package has Underwriters Laboratory Flammability Classification 94 V-O
- ◆ Low forward voltage drops, high current capability
- ◆ Glass passivated chip
- ◆ High Surge Capability
- ◆ 1.0 Ampere operation at $T_A = 25^\circ\text{C}$ with no thermal runaway
- ◆ Typical I_R less than $0.1 \mu\text{A}$
- ◆ High temperature soldering guaranteed: $250^\circ\text{C}/10$ seconds/.375", (9.5mm) lead length at 5 lbs., (2.3kg) tension

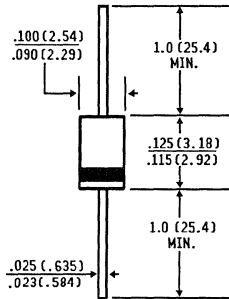

Dimensions in inches
and
(millimeters)

MECHANICAL DATA

Case: Molded plastic over glass passivated chip

Terminals: Plated Axial leads, solderable per MIL-STD-202, Method 208

Polarity: Color band denotes cathode

Mounting Position: Any

Weight: 0.0064 ounce, .181 grams

MAXIMUM RATINGS AND ELECTRICAL CHARACTERISTICS

Ratings at 25°C ambient temperature unless otherwise specified.
Resistive or inductive load.

SYMBOLS	RMPG	RMPG	RMPG	RMPG	RMPG	UNITS	
	06A	06B	06D	06G	06J		
Maximum Recurrent Peak Reverse Voltage	V_{RRM}	50	100	200	400	600	Volts
Maximum RMS Voltage	V_{RMS}	35	70	140	280	420	Volts
Maximum DC Blocking Voltage	V_{DC}	50	70	200	400	600	Volts
Maximum Average Forward Rectified Current, .375" (9.5mm) Lead Length at $T_A = 25^\circ\text{C}$	$I_{(AV)}$	1.0					Amps
Peak Forward Surge Current 8.3ms single half sine-wave superimposed on rated load (JEDEC Method) $T_A = 25^\circ\text{C}$	I_{FSM}	30.0					Amps
Maximum Instantaneous Forward Voltage at 1.0A	V_F	1.3					Volts
Maximum DC Reverse Current $T_A = 25^\circ\text{C}$ at Rated DC Blocking Voltage $T_A = 125^\circ\text{C}$	I_R	5.0 50.0					μA
Typical Junction Capacitance (Note 1)	C_J	6.6					pf
Maximum Reverse Recovery Time (Note 2) $T_J = 25^\circ\text{C}$	T_{RR}	150			200		ns
Thermal Resistance Typical Maximum (Note 3)	$R_{\theta JA}$	67.0 85.0					$^\circ\text{C}/\text{W}$
Operating and Storage Temperature Range	T_J, T_{STG}	-50 to +150					$^\circ\text{C}$

NOTES:

1. Measured at 1.0 MHz and applied reverse voltage of 4.0 Volts.
2. Reverse Recovery Test Conditions: $I_F = 0.5\text{A}$, $I_R = 1.0\text{A}$, $I_{rr} = 0.25\text{A}$.
3. Thermal Resistance from Junction to Ambient at .375" (9.5mm) Lead Lengths, P.C. Board Mounted.

RATINGS AND CHARACTERISTIC CURVES RMPG06A THRU RMPG06J

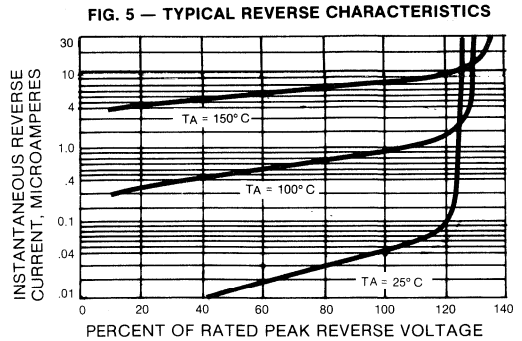
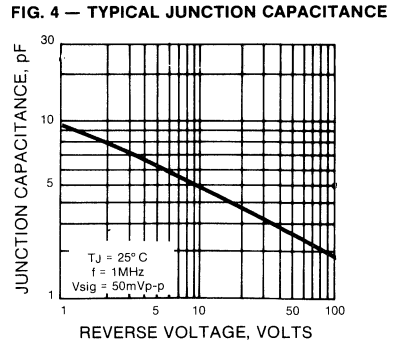
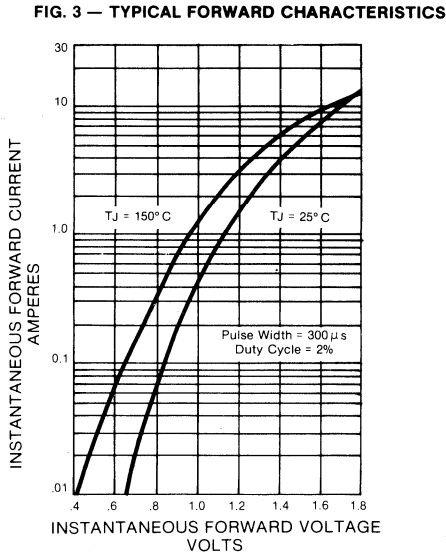
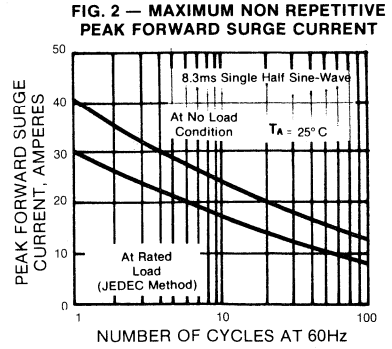
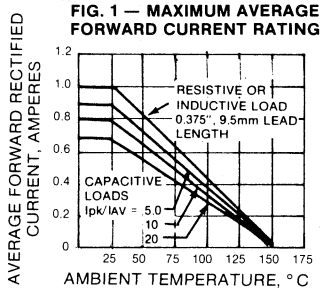

**GLASS PASSIVATED
RECTIFIERS**

***0.2 AMPERE TO 3.0 AMPERES
50 VOLTS TO 1600 VOLTS***

**GENERAL
INSTRUMENT**

GLASS PASSIVATED RECTIFIER

0.2 to 3.0 Amperes 50 Volts to 1600 Volts

Device Design

The Glass Passivated Rectifier is a hermetically sealed, cavity-free, diffused junction rectifier with unsurpassed operating and surge characteristics at high temperature.

Cavity-free construction with a specially developed extremely pure glass in direct contact with the silicon junction plus durable heat sink design obviate the need for solder joints and compression contact parts. The carefully matched expansion characteristics of the glass and metal parts in combination with the direct contact of the glass and silicon junction make the active rectifying elements impervious to surface contamination, moisture or other external chemical agents. Further, the long term degradation associated with organic junction protection is avoided.

There are many steps necessary to produce such a device:

1—Diffuse a PN junction into a slice of silicon

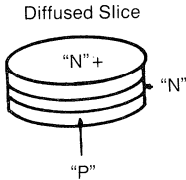

2—Evaporate aluminium on both sides of the slice to make metallurgical contact

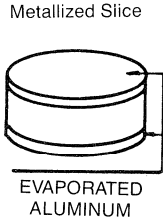

3—Sandblast the slice to produce a round beveled die

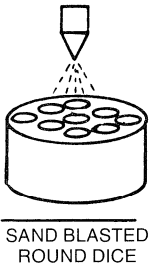

GLASS PASSIVATED RECTIFIERS

- 4—Brazing the die between two molybdenum heat sinks to which leads have been attached at approximately 700°C.

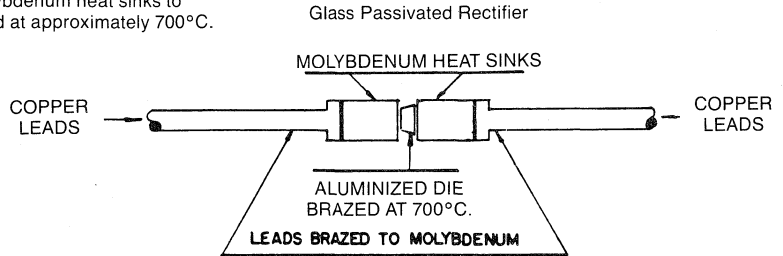

- 5—Clean the assembly by chemically etching, washing and drying.
6—Apply glass in the form of a frit to the die and molybdenum assembly.

- 7—Melt the glass by heating in an oven to approximately 600°C.

Glass Passivated Rectifier

- 8—Perform finishing operations such as lead tinning, electrical testing and marking.

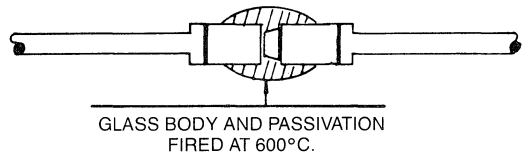

Package Design

The small size of the glass package with its capability up to 3 Ampere permits greater packing densities in electronic assemblies and equipment, while increasing reliability. Furthermore, only high temperature brazing operations are used to withstand the 600°C required to melt and fuse the glass. This technique eliminates solder construction and tremendously enhances mechanical strength and temperature cycling capability, increasing operating and storage temperature range while reducing thermal resistance.

Reliability

Specified reliability data on Glass Passivated Rectifier devices are available from the General Instrument Semiconductor Components Division Reliability Department. The basic design of the Glass Passivated rectifier and the strict positive controls over materials and manufacturing processes provide assurance-of failure-free performance under the most severe conditions. Processing facilities have been geared to follow the procedural requirements of Military Standard 750. Glass Passivated rectifiers are capable of withstanding environmental extremes in excess of MIL-S-19500E and of meeting requirements of MIL-STD-883, MIL-Q-9858 and MIL-I-45208. Assurance of production uniformity and reliability is provided by a test technique called "Operational Load Line Testing," which has proven product reliability with over 1 Billion Glass Passivated rectifiers now in use.

FAMILIES OF GENERAL INSTRUMENT GLASS PASSIVATED RECTIFIERS

Glass Passivated Silicon Diodes 0.2 to 0.4 AMPERES

Types:

1N483B thru 1N486B
1N645 thru 1N649

Features:

- ◆ High Temperature Metallurgically Bonded
- ◆ High Efficiency and Rectification Ratio
- ◆ Ideally Suited for Miniaturized Equipment
- ◆ Case: One Piece Glass, Hermetically Sealed
- ◆ Tin Plated Axial Leads, Solderable per MIL-STD-202/208
- ◆ Operating from -65 C to +175 C
- ◆ Low Leakage

Glass Passivated Silicon Rectifiers 1.0 to 3.0 AMPERES

Types:

1N4245 thru 1N4249
1N5059 thru 1N5062
1N5614 thru 1N5622
1N5550 thru 1N5554
1N5624 thru 1N5627
G1A thru G1M
G2A thru G2M
G3A thru G3M
G4A thru G4M

Features:

- ◆ Glass Passivated Junction
- ◆ High Mechanical Strength
- ◆ Storage up to 200 C
- ◆ Voidless Construction
- ◆ Hermetically Sealed
- ◆ Avalanche Operation
- ◆ Low Leakage
- ◆ High Conductance
- ◆ Tin Plated Axial Leads, Solderable per MIL-STD-202/208

Glass Passivated Fast Recovery Silicon Rectifiers 1.0 to 3.0 AMPERES

Types:

1N4942 thru 1N4948
1N5615 thru 1N5623
1N5415 thru 1N5420
RG1A thru RG1M
RG2A thru RG2M
RG3A thru RG3M
RG4A thru RG4M
BYV95 thru BYV96
BYW32 thru BYW36
BYW72 thru BYW76

Features:

- ◆ Glass Passivated Junction
- ◆ Fast Switching for High Rectification Efficiency to 100 kHz
- ◆ High Mechanical Strength
- ◆ Low Leakage
- ◆ Hermetically Sealed
- ◆ Storage up to 200 C
- ◆ Tin Plated Axial Leads, Solderable per MIL-STD-202/208

Glass Passivated High Voltage Silicon Rectifiers 0.3 to 3.0 AMPERES

Types:

CG1, DG1
CG1, DG1
CG2, DG2
CG3, DG3,
G11-1200 thru G11-1600
BY448, BY458, BY228

Features

- ◆ All Advantages of a Hermetically Sealed Glass
- ◆ passivated junction
- ◆ Especially designed for Clamper/Damper Applications in television /CRT
- ◆ Low Leakage
- ◆ High Mechanical Strength
- ◆ Tin Plated Axial Leads, Solderable per MIL-STD-202/208

QUICK GUIDE TO GLASS PASSIVATED RECTIFIERS

TYPE	1N483B thru 1N486B	1N645 thru 1N649	1N4245 thru 1N4249	1N4942* thru 1N4948*	1N5059 thru 1N5062	1N5614 thru 1N5622	1N5615* thru 1N5623*	G1A thru G1M	RG1A* thru RG1M*	TYPE
CASE	DO204MB	DO204MB	DO204AP	DO204AP	DO204AP	DO204AP	DO204AP	DO204AP	DO204AP	CASE
I_o (A)	0.2	0.4	1.0	1.0	1.0	1.0	1.0	1.0	1.0	I_o (A)
@ T_a (°C)	25	25	55	55	55	55	55	100	55	@ T_a (°C)
$V_R = 50$ (V)	1N483B							G1A	RG1A	$V_R = 50$ (V)
$V_R = 100$ (V)	1N485B							G1B	RG1B	$V_R = 100$ (V)
$V_R = 200$ (V)	1N486B	1N645	1N4245	1N4942	1N5059	1N5614	1N5615	G1D	RG1D	$V_R = 200$ (V)
$V_R = 300$ (V)		1N646								$V_R = 300$ (V)
$V_R = 400$ (V)		1N647	1N4246	1N4944	1N5060	1N5616	1N5617	G1G	RG1G	$V_R = 400$ (V)
$V_R = 500$ (V)		1N648								$V_R = 500$ (V)
$V_R = 600$ (V)		1N649	1N4247	1N4946	1N5061	1N5618	1N5619	G1J	RG1J	$V_R = 600$ (V)
$V_R = 800$ (V)			1N4248	1N4947	1N5062	1N5620	1N5621	G1K	RG1K	$V_R = 800$ (V)
$V_R = 1000$ (V)			1N4249	1N4948		1N5622	1N5623	G1M	RG1M	$V_R = 1000$ (V)
$V_R > 1000$ (V)										$V_R > 1000$ (V)
SURGE (A)	2.0	15	25	30	50	50	50	50	30	SURGE (A)
V_F (V)	1.0	1.0	1.2	1.3	1.2	1.2	1.2	1.1	1.3	V_F (V)

*Fast Recovery

QUICK GUIDE TO GLASS PASSIVATED RECTIFIERS

TYPE	CG1 and DG1	G2A thru G2M	RG2A* thru RG2M*	CG2 AND DG2	1N5624 thru 1N5627	1N5550 thru 1N5559	1N5415* thru 1N5420*	G3A thru G3M	G4A thru G4M	RG3A* thru RG3M*	RG4A thru RG4M	CG3 and DG3	TYPE
CASE	DO204AP	DO204AP	DO204AP	DO204AP	GPR3	GPR4	GPR4	GPR3	GPR4	GPR3	GPR4	GPR3	CASE
I_o (A)	1.5	2.0	2.0	2.0	3.0	3.0	3.0	3.0	3.0	3.0	3.0	3.0	I_o (A)
T_a (°C)	55	70	55	50	70	55	55	70	70	55	50	50	T_a (°C)
$V_R = 50$ (V)		G2A	RG2A				1N5415	G3A	G4A	RG3A	RG4A		$V_R = 50$ (V)
$V_R = 100$ (V)		G2B	RG2B				1N5416	G3B	G4B	RG3B	RG4B		$V_R = 100$ (V)
$V_R = 200$ (V)		G2D	RG2D		1N5624	1N5550	1N5417	G3D	G4D	RG3D	RG4D		$V_R = 200$ (V)
$V_R = 300$ (V)													$V_R = 300$ (V)
$V_R = 400$ (V)		G2G	RG2G		1N5625	1N5551	1N5418	G3G	G4G	RG3G	RG4G		$V_R = 400$ (V)
$V_R = 500$ (V)							1N5419						$V_R = 500$ (V)
$V_R = 600$ (V)		G2J	RG2J		1N5626	1N5552	1N5420	G3J	G4J	RG3J	RG4J		$V_R = 600$ (V)
$V_R = 800$ (V)		G2K	RG2K		1N5627	1N5553		G3K	G4K	RG3K	RG4K		$V_R = 800$ (V)
$V_R = 1000$ (V)		G2M	RG2M			1N5554		G3M	G4M	RG3M	RG4M		$V_R = 1000$ (V)
$V_R > 1000$ (V)	CG1/DG1			CG2/DG2								CG3/DG3	$V_R > 1000$ (V)
SURGE (A)	40	50	50	40	125	100	80	125	125	100	100	100	SURGE (A)
V_F (V)	1.0	1.2	1.3	1.1	1.0	1.2/1.3	1.1	1.1	1.1	1.3	1.3	1.2	V_F (V)

*Fast Recovery

1N483B THRU 1N486B

LOW POWER MINIATURE GLASS PASSIVATED SILICON RECTIFIER

Voltage - 70 to 225 Volts Current - 200 Milliamperes

FEATURES

- ◆ High temperature metallurgically bonded constructed rectifiers
- ◆ 0.2 Ampere operation at $T_A = 25^\circ\text{C}$ with no thermal runaway
- ◆ Typical I_R less than $0.1 \mu\text{A}$
- ◆ Hermetically sealed package
- ◆ Glass passivated cavity-free junction
- ◆ Ideally suited for miniaturized equipment
- ◆ Capable of meeting environmental standards of MIL-S-19500
- ◆ High temperature soldering guaranteed: $350^\circ\text{C}/10$ seconds/.375", (9.5mm) lead length at 5 lbs., (2.3kg) tension

MECHANICAL DATA

Case: One piece glass, hermetically sealed
Terminals: Plated Axial leads, solderable per MIL-STD-202, Method 208
Polarity: Color band denotes cathode
Mounting Position: Any
Weight: .02 ounce, .56 grams

PATENTED*

DO-204MB

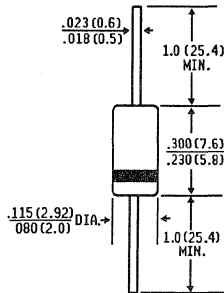

Dimension in inches and (millimeters)

* Brazed-lead assembly is covered by Patent No. 3,930,306 of 1976 and glass composition by Patent No.3,752,701 of 1973

MAXIMUM RATINGS AND ELECTRICAL CHARACTERISTICS

Ratings at 25°C ambient temperature unless otherwise specified.
 Single phase, half wave, 60 Hz, resistive or inductive load.
 For capacitive load, derate current by 20%.

	SYMBOLS	1N483B	1N485B	1N486B	UNITS
*Maximum Recurrent Peak Reverse Voltage	V_{RRM}	70	180	225	Volts
Maximum RMS Voltage	V_{RMS}	50	127	159	Volts
*Maximum DC Blocking Voltage	V_{DC}	70	180	225	Volts
*Maximum Reverse Breakdown Voltage at $100 \mu\text{A}$	V_{BR}	80	200	250	Volts
*Maximum Average Forward Rectified Current $T_A = 25^\circ\text{C}$.375", (9.5mm) Lead Lengths at $T_A = 150^\circ\text{C}$	$I_{(AV)}$		200 50.0		Mili Amps
*Peak Forward Surge Current 8.3ms single half sine-wave superimposed on rated load (JEDEC Method)	I_{FSM}		2.0		Amps
*Maximum Instantaneous Forward Voltage at 100mA	V_F		1.0		Volts
*Maximum DC Reverse Current $T_A = 25^\circ\text{C}$ at Rated DC Blocking Voltage $T_A = 150^\circ\text{C}$	I_R		25.0 5.0		nA μA
Typical Reverse Recovery Time (Note 4)	T_{RR}		2.0		μs
Typical Junction Capacitance (Note 1)	C_J		15.0		pf
Typical Thermal Resistance (Note 3)	$R_{\theta JA}$		81.0		$^\circ\text{C}/\text{W}$
*Operating and Storage Temperature Range	T_J, T_{STG}		-65 to +200		$^\circ\text{C}$

NOTES:

1. Measured at 1 MHz and applied reverse voltage of 4.0 V_{DC}.
2. Available to JAN and JANTX Military Specifications MIL-S-19500/118C.
3. Thermal Resistance from Junction to Ambient at .375" (9.5mm) Lead Lengths, P.C. Board Mounted.
4. Reverse Recovery Test Conditions: $I_F = 0.5\text{A}$, $I_R = 1.0\text{A}$, $I_{rr} = .25\text{A}$
*JEDEC Registered Values

RATING AND CHARACTERISTIC CURVES 1N483B THRU 1N486B

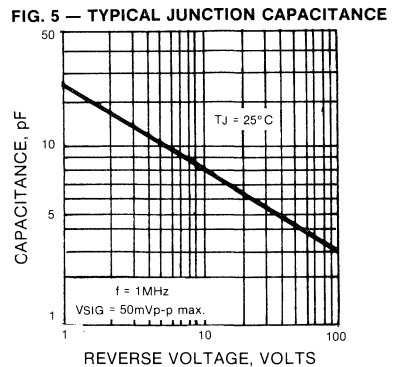
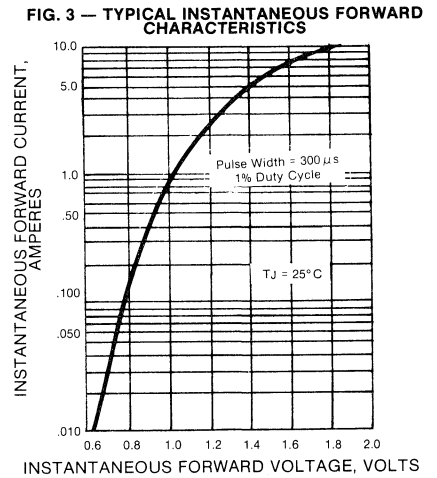
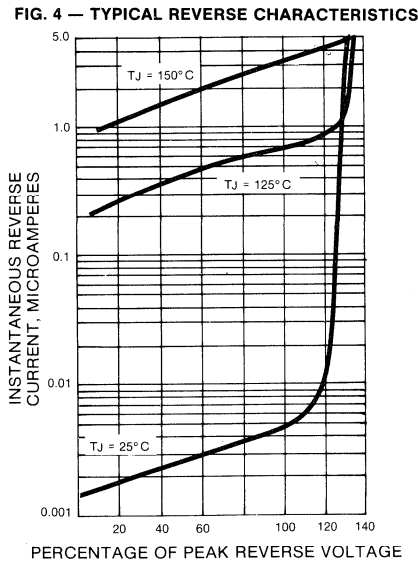
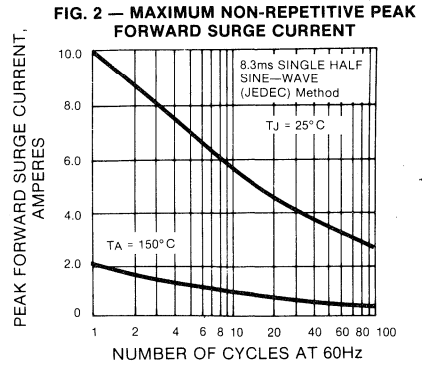
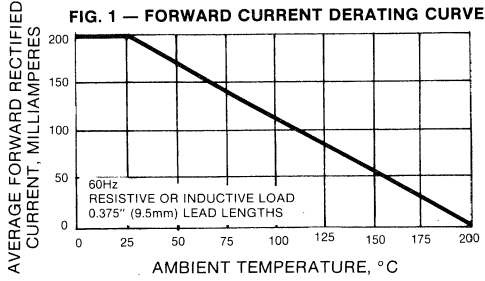

1N645 THRU 1N649

MINIATURE GLASS PASSIVATED SILICON RECTIFIER

Voltage - 225 to 600 Volts Current- 400 Milliamperes

FEATURES

- ◆ High temperature metallurgically bonded compression contacts as found in diode-constructed rectifiers
- ◆ 0.4 Ampere operation at $T_A = 25^\circ\text{C}$ with no thermal runaway
- ◆ Hermetically sealed package
- ◆ Glass passivated cavity-free junction
- ◆ Ideally suited for miniaturized equipment
- ◆ Capable of meeting environmental standards of MIL-S-19500
- ◆ High temperature soldering guaranteed $350^\circ\text{C}/10$ seconds/.375", (9.5mm) lead length at 5 lbs., (2.3kg) tension

MECHANICAL DATA

Case: One piece glass, hermetically sealed

Terminals: Plated Axial leads, solderable per MIL-STD-202, Method 208

Polarity: Color band denotes cathode

Mounting Position: Any

Weight: .02 ounce, .56 gram

PATENTED*

DO-204MB

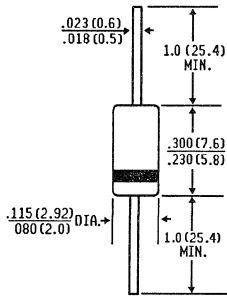

Dimension in inches
and
(millimeters)

* Brazed-lead assembly is covered by Patent No. 3,930,306 of 1976 and glass composition by Patent No.3,752,701 of 1973

MAXIMUM RATINGS AND ELECTRICAL CHARACTERISTICS

Ratings at 25°C ambient temperature unless otherwise specified.
Single phase, half wave, 60 Hz, resistive or inductive load.
For capacitive load, derate current by 20%.

	SYMBOLS	1N645	1N646	1N647	1N648	1N649	UNITS
*Maximum Recurrent Peak Reverse Voltage	V_{RRM}	225	300	400	500	600	Volts
Maximum RMS Voltage	V_{RMS}	156	210	280	350	420	Volts
Maximum DC Blocking Voltage	V_{DC}	225	300	400	500	600	Volts
*Minimum Avalanche Breakdown Voltage at $T_A = 100^\circ\text{C}$	V_{BR}	275	360	480	600	720	Volts
*Maximum Average Forward Rectified Current .375", (9.5mm) Lead Lengths at $T_A = 25^\circ\text{C}$ $T_A = 150^\circ\text{C}$	$I_{(AV)}$	400 150					Mili-Amps
Peak Forward Surge Current 8.3ms single half sine-wave superimposed on rated load (JEDEC Method)	I_{FSM}	15.0					Amps
*Maximum Instantaneous Forward Voltage at 400mA	V_F	1.0					Volts
*Maximum DC Reverse Current $T_A = 25^\circ\text{C}$ at Rated DC Blocking Voltage $T_A = 100^\circ\text{C}$	I_R	200 15 15 20 20 25					nA μA
Typical Junction Capacitance (Note 1)	C_J	15.0					pf
Typical Thermal Resistance (Note 3)	$R_{\theta JA}$	81.0					$^\circ\text{C}/\text{W}$
Operating Temperature Range	T_J	-65 to +175					$^\circ\text{C}$
Storage Temperature Range	T_{STG}	-65 to +200					$^\circ\text{C}$

NOTES:

1. Measured at 1 MHz and applied reverse voltage of 4.0 V_{DC} .
 2. Available to Jan and Jan TX Military Specifications MIL-STD-19500/240.
 3. Thermal Resistance from Junction to Ambient at .375" (9.5mm) Lead Lengths, P.C. Board Mounted.
- * JEDEC Registered Values

RATING AND CHARACTERISTIC CURVES 1N645 THRU 1N649

FIG. 1 — TYPICAL INSTANTANEOUS FORWARD CHARACTERISTICS

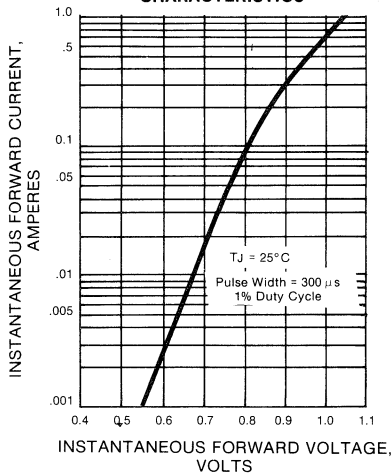

FIG. 2 — FORWARD CURRENT DERATING CURVE

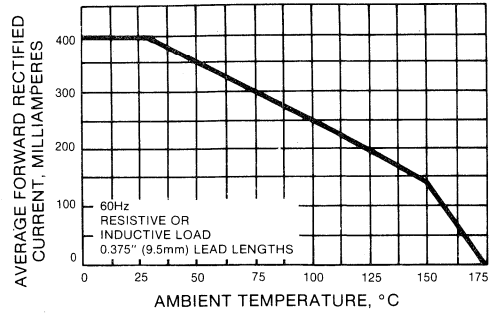

FIG. 4 — MAXIMUM NON-REPTITIVE PEAK FORWARD SURGE CURRENT

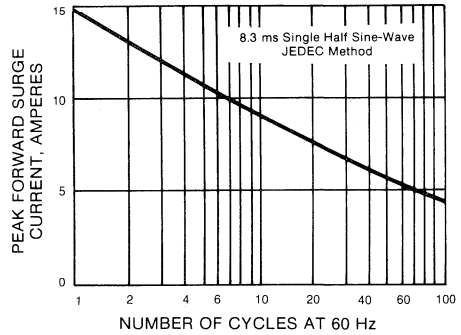

FIG. 3 — TYPICAL REVERSE LEAKAGE CHARACTERISTICS

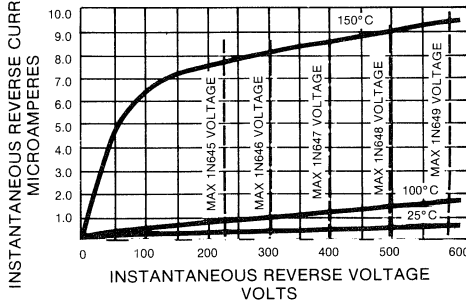
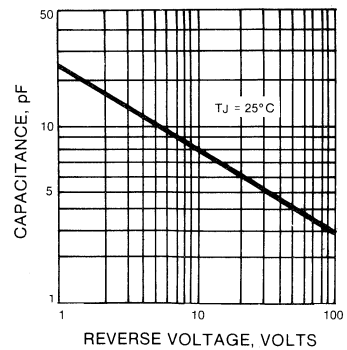

FIG. 5 — TYPICAL JUNCTION CAPACITANCE



1N4245 THRU 1N4249

MINIATURE GLASS PASSIVATED SILICON RECTIFIER

Voltage - 200 to 1000 Volts Current - 1.0 Ampere

FEATURES

PATENTED*

DO-204AP

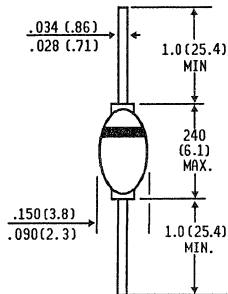

*Dimensions in inches
and
(millimeters)*

- ◆ High temperature metallurgically bonded constructed rectifiers
- ◆ 1.0 Ampere operation at $T_A = 55^\circ\text{C}$ with no thermal runaway
- ◆ Typical I_R less than $0.1 \mu\text{A}$
- ◆ Hermetically sealed package
- ◆ Capable of meeting environmental standards of MIL-S-19500
- ◆ High temperature soldering guaranteed: $350^\circ\text{C}/10$ seconds/.375", (9.5mm) lead length at 5 lbs., (2.3kg) tension

MECHANICAL DATA

Case: One piece glass, hermetically sealed

Terminals: Plated Axial leads, solderable per MIL-STD-202, Method 208

Polarity: Color band denotes cathode

Mounting Position: Any

Weight: .02 ounce, .56 grams

* Brazed-lead assembly is covered by Patent No. 3,930,306 of 1976 and glass composition by Patent No. 3,752,701 of 1973

MAXIMUM RATINGS AND ELECTRICAL CHARACTERISTICS

Ratings at 25°C ambient temperature unless otherwise specified.

Single phase, half wave, 60 Hz, resistive or inductive load. For capacitive load, derate current by 20%.

	SYMBOLS	1N4245	1N4246	1N4247	1N4248	1N4249	UNITS
*Maximum Recurrent Peak Reverse Voltage	V_{RRM}	200	400	600	800	1000	Volts
Maximum RMS Voltage	V_{RMS}	140	280	420	560	700	Volts
*Maximum DC Blocking Voltage	V_{DC}	200	400	600	800	1000	Volts
*Maximum Average Forward Rectified Current .375", (9.5mm) Lead Lengths at $T_A = 55^\circ\text{C}$	$I_{(AV)}$	1.0					Amps
*Peak Forward Surge Current 8.3ms single half sine-wave superimposed on rated load (JEDEC Method)	I_{FSM}	50.0					Amps
*Maximum Instantaneous Forward Voltage at 1.0A	V_F	1.2					Volts
*Maximum Full Load Reverse Current, Full Cycle Average .375", (9.5mm) Lead Lengths at $T_A = 55^\circ\text{C}$	$I_{R(AV)}$	50.0					μA
*Maximum Reverse Current $T_A = 25^\circ\text{C}$ at Rated DC Blocking Voltage $T_A = 125^\circ\text{C}$	I_R	1.0 25.0					μA
Typical Junction Capacitance (Note 2)	C_J	15.0					pf
Typical Thermal Resistance (Note 3)	$R_{\theta JA}$	40.0					$^\circ\text{C}/\text{W}$
*Operating Temperature Range	T_J	-65 to +160					$^\circ\text{C}$
*Storage Temperature Range	T_{STG}	-65 to +200					$^\circ\text{C}$

NOTES:

1. Available to JAN and JAN TX Military Specifications MIL-S-19500 / 286C
 2. Measured at 1 MHz and applied reverse voltage of 4.0 volts.
 3. Thermal Resistance from Junction to Ambient at .375" (9.5mm) Lead Lengths, P.C. Board Mounted.
- *JEDEC Registered Values

RATING AND CHARACTERISTIC CURVES 1N4245 THRU 1N4249

FIG. 1 — FORWARD DERATING CURVE

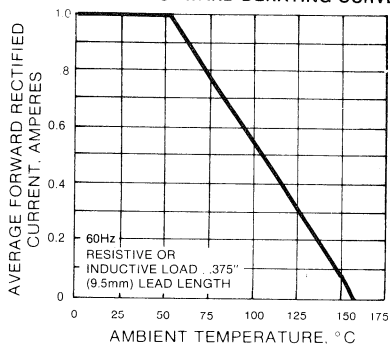

FIG. 2 — TYPICAL INSTANTANEOUS FORWARD CHARACTERISTICS

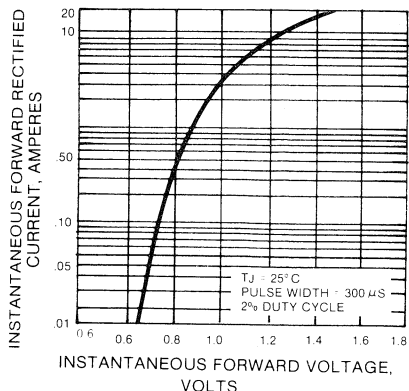

FIG. 3 — MAXIMUM NON-REPETITIVE PEAK FORWARD SURGE CURRENT

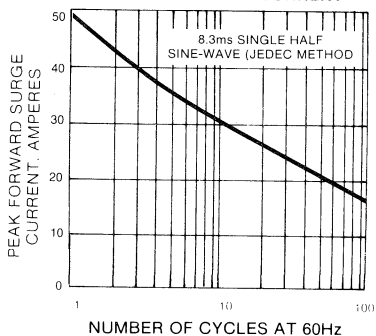

FIG. 4 — TYPICAL JUNCTION CAPACITANCE

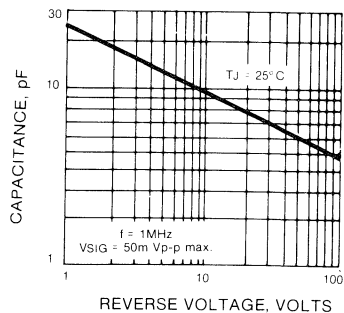
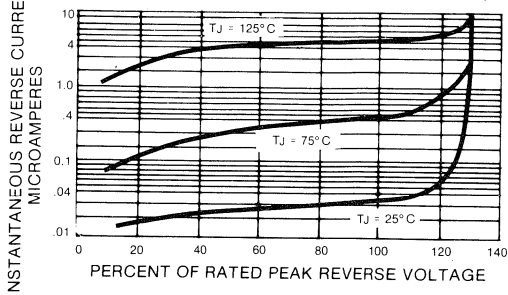

FIG. 5 — TYPICAL REVERSE CHARACTERISTICS



1N5059 THRU 1N5062

MINIATURE GLASS PASSIVATED SILICON RECTIFIER

Voltage - 200 to 800 Volts **Current** - 1.0 Ampere

FEATURES

PATENTED*

DO-204AP

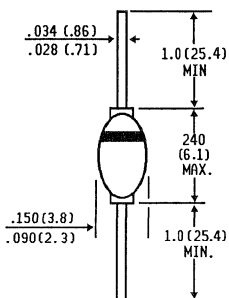

Dimensions in inches
and
(millimeters)

*Braze-lead assembly is covered by Patent No. 3,930,306 of 1976
and glass composition by Patent No. 3,752,701 of 1973

- ◆ High temperature metallurgically bonded constructed rectifiers
- ◆ 1.0 Ampere operation at $T_A = 75^\circ\text{C}$ with no thermal runaway
- ◆ Typical I_R less than $0.1 \mu\text{A}$
- ◆ Hermetically sealed package
- ◆ Glass passivated cavity-free junction DO-204AP package
- ◆ Capable of meeting environmental standards of MIL-S-19500
- ◆ High temperature soldering guaranteed: $350^\circ\text{C}/10$ seconds/.375", (9.5mm) lead length at 5 lbs., (2.3kg) tension

MECHANICAL DATA

Case: One piece glass, hermetically sealed

Terminals: Plated Axial leads, solderable per MIL-STD-202, Method 208

Polarity: Color band denotes cathode

Mounting Position: Any

Weight: .02 ounce, .56 grams

MAXIMUM RATINGS AND ELECTRICAL CHARACTERISTICS

Ratings at 25°C ambient temperature unless otherwise specified.

Single phase, half wave, 60 Hz, resistive or inductive load. For capacitive load, derate current by 20%.

	SYMBOLS	1N5059	1N5060	1N5061	1N5062	UNITS
*Maximum Recurrent Peak Reverse Voltage	V_{RRM}	200	400	600	800	Volts
Maximum RMS Voltage	V_{RMS}	140	280	420	560	Volts
*Maximum DC Blocking Voltage	V_{DC}	200	400	600	800	Volts
*Maximum Average Forward Rectified Current .375", (9.5mm) Lead Lengths at $T_A = 75^\circ\text{C}$	$I_{(AV)}$	1.0				Amps
*Peak Forward Surge Current 8.3ms single half sine-wave superimposed on rated load (JEDEC Method)	I_{FSM}	50.0				Amps
*Maximum Instantaneous Forward Voltage at 1.0A	V_F	1.2				Volts
*Maximum Full Load Reverse Current, Full Cycle Average .375", (9.5mm) $T_A = 25^\circ\text{C}$ Lead Lengths at $T_A = 75^\circ\text{C}$	$I_{R(AV)}$	150	100			μA
*Maximum DC Reverse Current at Rated DC Blocking Voltage $T_A = 175^\circ\text{C}$	I_R	300	200			μA
Typical Reverse Recovery Time (Note 1)	T_{RR}	2.0				μs
Typical Junction Capacitance (Note 2)	C_J	15.0				pf
Typical Thermal Resistance (Note 3)	$R_{\theta JA}$	40.0				$^\circ\text{C}/\text{W}$
*Operating and Storage Temperature Range	T_J, T_{STG}	-65 to +175				$^\circ\text{C}$

NOTES:

1. Reverse Recovery Test Conditions : $I_F = 0.5\text{A}$, $I_R = 1.0\text{A}$, $I_{rr} = .25\text{A}$
 2. Measured at 1 MHz and applied reverse voltage of 4.0 volts.
 3. Thermal Resistance from Junction to Ambient at .375" (9.5mm) Lead Lengths, P.C. Board Mounted.
- *JEDEC Registered Values

RATING AND CHARACTERISTIC CURVES 1N5059 THRU 1N5062

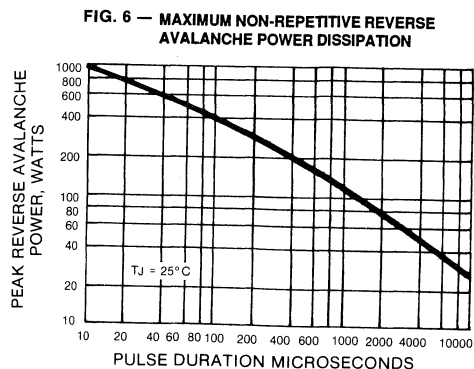
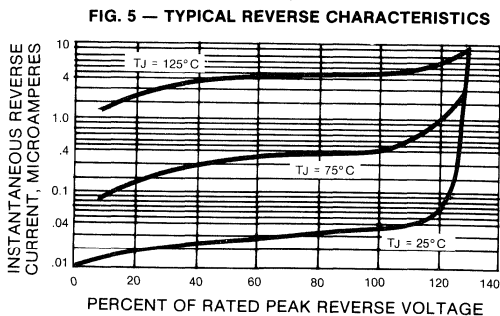
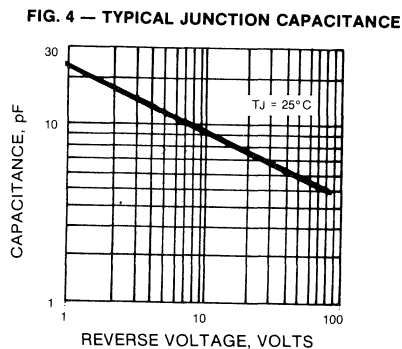
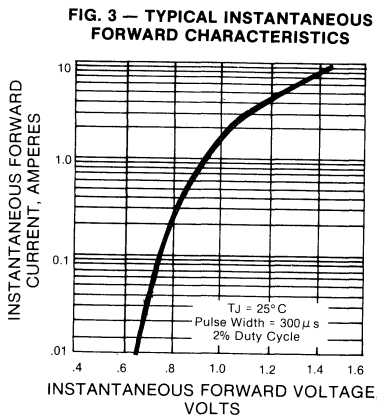
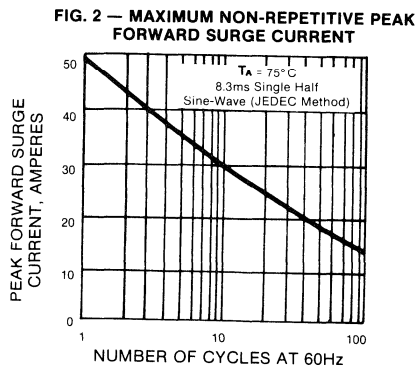
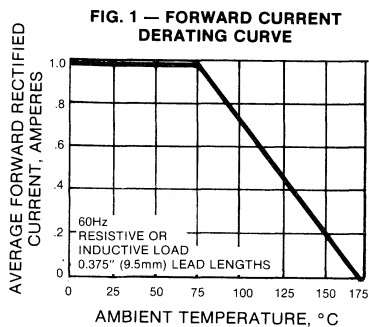

1N5614 THRU 1N5622

**MINIATURE GLASS PASSIVATED
MEDIUM-SWITCHING SILICON RECTIFIER**
Voltage - 200 to 1000 Volts Current - 1.0 Ampere

FEATURES

- ◆ High temperature metallurgically bonded constructed rectifiers
- ◆ 1.0 Ampere operation at $T_A = 55^\circ\text{C}$ with no thermal runaway
- ◆ Typical I_R less than $0.1 \mu\text{A}$
- ◆ Hermetically sealed package
- ◆ Capable of meeting environmental standards of MIL-S-19500
- ◆ High temperature soldering guaranteed: $350^\circ\text{C}/10$ seconds/.375", (9.5mm) lead length at 5 lbs., (2.3kg) tension

PATENTED*

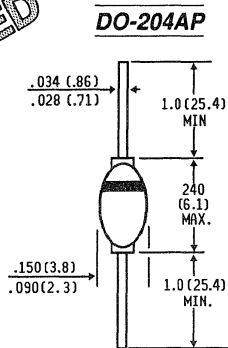

Dimensions in inches
and
(millimeters)

*Brazed-lead assembly is covered by Patent No. 3,930,306 of 1976
and glass composition by Patent No. 3,752,701 of 1973

MECHANICAL DATA

Case: One piece glass, hermetically sealed

Terminals: Plated Axial leads, solderable per MIL-STD-202, Method 208

Polarity: Color band denotes cathode

Mounting Position: Any

Weight: .02 ounce, .56 grams

MAXIMUM RATINGS AND ELECTRICAL CHARACTERISTICS

Ratings at 25°C ambient temperature unless otherwise specified.
Single phase, half wave, 60 Hz, resistive or inductive load. For capacitive load, derate current by 20%.

	SYMBOLS	1N5614	1N5616	1N5618	1N5620	1N5622	UNITS
*Maximum Recurrent Peak Reverse Voltage	V_{RRM}	200	400	600	800	1000	Volts
Maximum RMS Voltage	V_{RMS}	140	280	420	560	700	Volts
*Maximum DC Blocking Voltage	V_{DC}	200	400	600	800	1000	Volts
*Minimum Avalanche Breakdown Voltage at $50 \mu\text{A}$	V_{BR}	220	440	660	880	1100	Volts
Maximum Average Forward Rectified Current .375", (9.5mm) Lead Lengths at $T_A = 55^\circ\text{C}$	$I_{(AV)}$	1.0					Amps
*Peak Forward Surge Current 8.3ms single half sine-wave superimposed on rated load (JEDEC Method)	I_{FSM}	50.0					Amps
*Maximum Instantaneous Forward Voltage at 1.0A	V_F	1.2					Volts
*Maximum DC Reverse Current $T_A = 25^\circ\text{C}$ at Rated DC Blocking Voltage $T_A = 100^\circ\text{C}$ $T_A = 200^\circ\text{C}$	I_R	0.5 25.0 1500					μA
*Maximum Reverse Recovery Time (Note 1)	T_{RR}	2.0					μs
Typical Junction Capacitance (Note 2)	C_J	45	35	25	20	15	pf
Typical Thermal Resistance (Note 4)	$R_{\theta JA}$	40.0					$^\circ\text{C}/\text{W}$
*Operating Temperature Range	T_J	-65 to +175					$^\circ\text{C}$
*Storage Temperature Range	T_{STG}	-65 to +200					$^\circ\text{C}$

- NOTES: 1. Reverse Recovery Test Conditions: $I_F = .5\text{A}$, $I_R = 1.0\text{A}$, $I_{rr} = .25\text{A}$.
2. Measured at 1 MHz and applied reverse voltage of 12 volts.
3. Available to Jan and Jan TX Military Specifications MIL-S-19500/427.
4. Thermal Resistance from Junction to Ambient at .375" (9.5mm) Lead Lengths, P.C. Board Mounted.
* JEDEC Registered Values

RATING AND CHARACTERISTIC CURVES 1N5614 THRU 1N5622

FIG. 1 — REVERSE RECOVERY TIME CHARACTERISTIC AND TEST CIRCUIT DIAGRAM

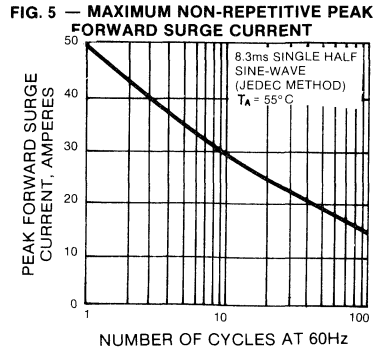
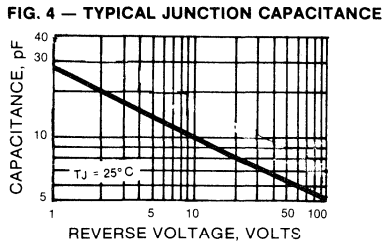
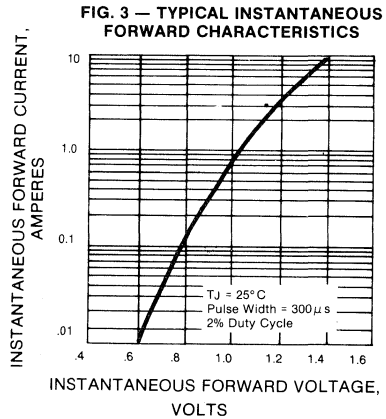
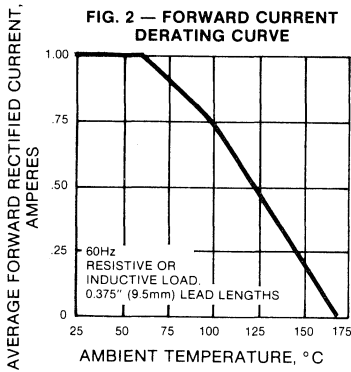
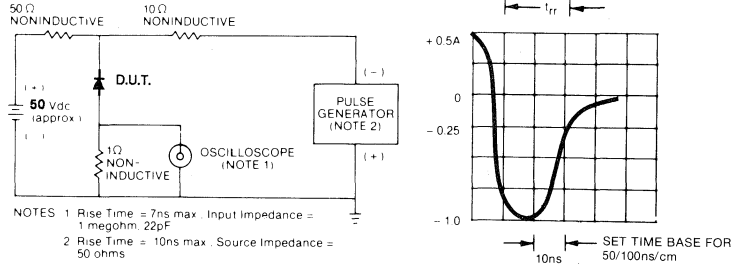

G1A THRU G1M

MINIATURE GLASS PASSIVATED SILICON RECTIFIER

Voltage - 50 to 1000 Volts Current- 1.0 Ampere

FEATURES

PATENTED*
DO-204AP

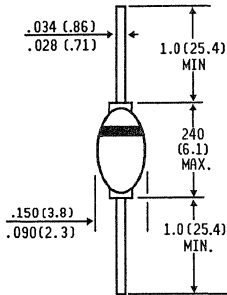

Dimensions in inches and (millimeters)

* Brazed-lead assembly is covered by Patent No. 3,930,306 of 1976 and glass composition by Patent No.3,752,701 of 1973

- ◆ High temperature metallurgically bonded constructed rectifiers
- ◆ Glass passivated cavity-free junction in DO-204AP package
- ◆ 1.0 Ampere operation at $T_A = 55^\circ\text{C}$ with no thermal runaway
- ◆ Typical I_R less than $0.1 \mu\text{A}$
- ◆ Capable of meeting environmental standards of MIL-S-19500
- ◆ High temperature soldering guaranteed: $350^\circ\text{C}/10$ seconds/.375", (9.5mm) lead length at 5 lbs., (2.3kg) tension

MECHANICAL DATA

Case: One piece glass, hermetically sealed
Terminals: Plated Axial leads, solderable per MIL-STD-202, Method 208
Polarity: Color band denotes cathode
Mounting Position: Any
Weight: .02 ounce, .56 grams

MAXIMUM RATINGS AND ELECTRICAL CHARACTERISTICS

Ratings at 25°C ambient temperature unless otherwise specified.
 Single phase, half wave, 60Hz, resistive or inductive load.
 For capacitive load, derate current by 20%

	SYMBOLS	G1A	G1B	G1D	G1G	G1J	G1K	G1M	UNITS
Maximum Recurrent Peak Reverse Voltage	V_{RRM}	50	100	200	400	600	800	1000	Volts
Maximum RMS Voltage	V_{RMS}	35	70	140	280	420	560	700	Volts
Maximum DC Blocking Voltage	V_{DC}	50	70	200	400	600	800	1000	Volts
Maximum Average Forward Rectified Current, .375" (9.5mm) Lead Length at $T_A = 55^\circ\text{C}$	$I_{(AV)}$	1.0							Amps
Peak Forward Surge Current 8.3ms single half sine-wave superimposed on rated load (JEDEC Method)	I_{FSM}	50.0							Amps
Maximum Instantaneous Forward Voltage at 1.0A	V_F	1.2		1.1				Volts	
Maximum Full Load Reverse Current, Full Cycle Average, .375", (9.5mm) Lead Length at $T_A = 100^\circ\text{C}$	$I_{R(AV)}$	200							μA
Maximum DC Reverse Current $T_A = 25^\circ\text{C}$ at Rated DC Blocking Voltage $T_A = 150^\circ\text{C}$	I_R	2.0							μA
Typical Reverse Recovery Time (Note 1) $T_J = 25^\circ\text{C}$	T_{RR}	2.0							μs
Typical Junction Capacitance (Note 2)	C_J	15.0							pf
Typical Thermal Resistance (Note 3)	$R_{\theta JA}$	40.0							$^\circ\text{C}/\text{W}$
Operating and Storage Temperature Range	T_J, T_{STG}	-65 to 175							$^\circ\text{C}$

NOTES:

1. Measured with $I_F = 0.5\text{A}$, $I_R = 1.0\text{A}$, $I_{rr} = .25\text{A}$.
2. Measured at 1.0 MHz and applied reverse voltage of 4.0 V_{DC} .
3. Thermal Resistance from Junction to Ambient at .375" (9.5mm) Lead Lengths, P.C. Board Mounted.

RATINGS AND CHARACTERISTIC CURVES G1A THRU G1M

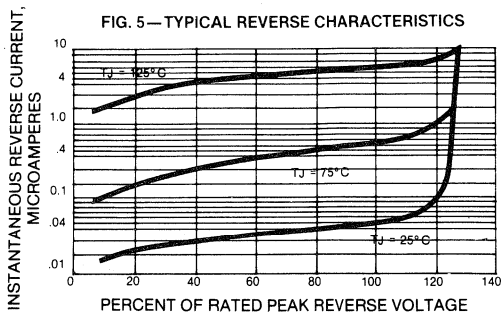
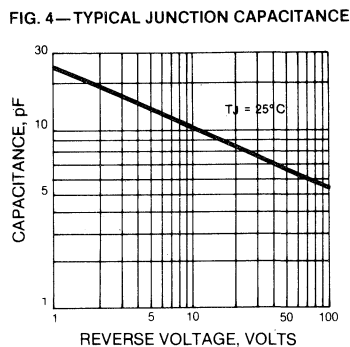
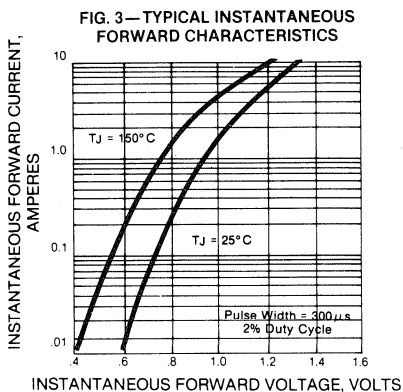
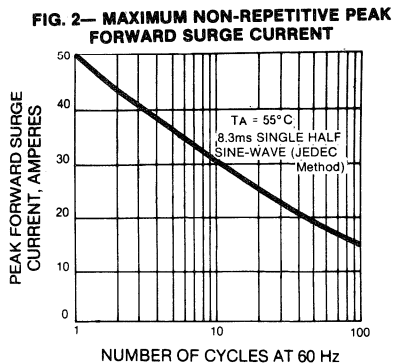
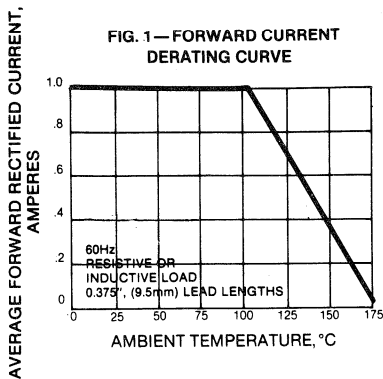

G2A THRU G2M

MINIATURE GLASS PASSIVATED JUNCTION RECTIFIER

Voltage - 50 to 1000 Volts Current- 2.0 Amperes

FEATURES

- ◆ High temperature metallurgically bonded constructed rectifiers
- ◆ Glass passivated cavity-free junction in DO-204AP package
- ◆ 2.0 Ampere operation at $T_A = 75^\circ\text{C}$ with no thermal runaway
- ◆ Typical I_R less than $0.1 \mu\text{A}$
- ◆ Capable of meeting environmental standards of MIL-S-19500
- ◆ Fast switching for high efficiency
- ◆ High temperature soldering guaranteed: $350^\circ\text{C}/10$ seconds/.375", (9.5mm) lead length at 5 lbs., (2.3kg) tension

PATENTED*

DO-204AP

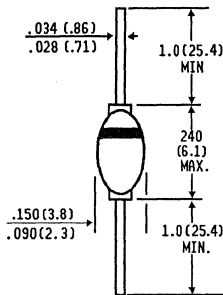

Dimensions in inches
and
millimeters

* Brazed-lead assembly is covered by Patent No. 3,930,306 of 1976 and glass composition by Patent No. 3,752,701 of 1973

MECHANICAL DATA

Case: One piece glass, hermetically sealed

Terminals: Axial leads, solderable per MIL-STD-202, Method 208

Polarity: Color band denotes cathode

Mounting Position: Any

Weight: .02 ounce, .56 grams

MAXIMUM RATINGS AND ELECTRICAL CHARACTERISTICS

Ratings at 25°C ambient temperature unless otherwise specified.
Single phase, half wave, 60Hz, resistive or inductive load.
For capacitive load, derate current by 20%

	SYMBOLS	G2A	G2B	G2D	G2G	G2J	G2K	G2M	UNITS
Maximum Recurrent Peak Reverse Voltage	V_{RRM}	50	100	200	400	600	800	1000	Volts
Maximum RMS Voltage	V_{RMS}	35	70	140	280	420	560	700	Volts
Maximum DC Blocking Voltage	V_{DC}	50	100	200	400	600	800	1000	Volts
Maximum Average Forward Rectified Current, .375" (9.5mm) Lead Length at $T_A = 75^\circ\text{C}$	$I_{(AV)}$	2.0							Amps
Peak Forward Surge Current 8.3ms single half sine-wave superimposed on rated load (JEDEC Method)	I_{FSM}	50							Amps
Maximum Instantaneous Forward Voltage at 2.0A	V_F	1.2		1.1					Volts
Maximum Full Load Reverse Current, Full Cycle Average, .375", (9.5mm) Lead Length at $T_A = 100^\circ\text{C}$	$I_{R(AV)}$	100							μA
Maximum DC Reverse Current at Rated DC Blocking Voltage	I_R	1.0							μA
Typical Reverse Recovery Time (Note 1) $T_J = 25^\circ\text{C}$	T_{RR}	2.0							μs
Typical Junction Capacitance (Note 2)	C_J	15.0							pf
Typical Thermal Resistance (Note 3)	$R_{\theta JA}$	40.0							$^\circ\text{C/W}$
Operating and Storage Temperature Range	T_J, T_{STG}	-65 to 175							$^\circ\text{C}$

NOTES:

1. Measured with $I_F = .5\text{A}$, $I_R = 1\text{A}$, $I_{rr} = .25\text{A}$.
2. Measured at 1.0 MHz and applied reverse voltage of 4.0 Vpc.
3. Thermal Resistance from Junction to Ambient at .375" (9.5mm) Lead Lengths, P.C. Board Mounted.

RATINGS AND CHARACTERISTIC CURVES G2A THRU G2M

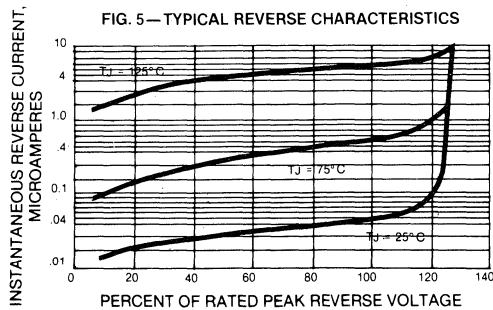
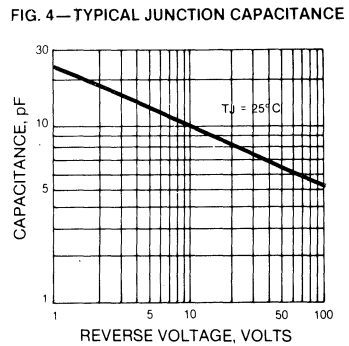
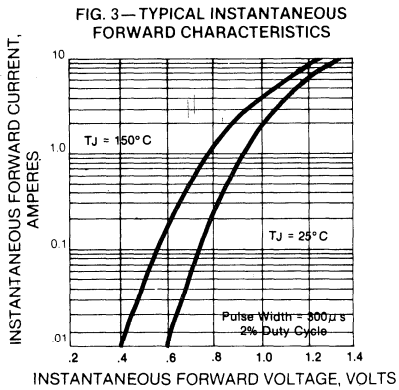
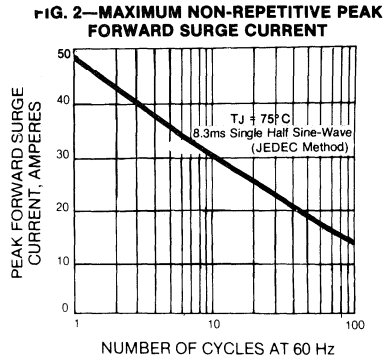
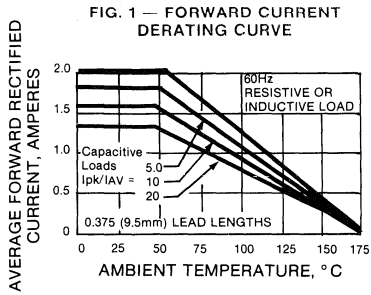

1N5550 THRU 1N5554

GLASS PASSIVATED SILICON RECTIFIER
Voltage - 200 to 1000 Volts Current - 3.0 Amperes

FEATURES

- ◆ Glass passivated cavity-free junction
- ◆ High temperature metallurgically bonded
- ◆ Hermetically sealed package
- ◆ Capable of meeting environmental standards of MIL-S-19500
- ◆ Medium switching for good efficiency
- ◆ High temperature soldering guaranteed: 350°C/10 seconds/.375", (9.5mm) lead length at 5 lbs., (2.3kg) tension

PATENTED*

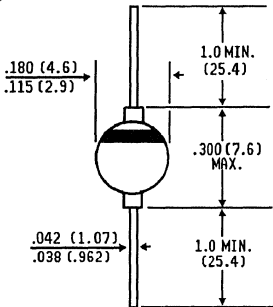

Dimensions in inches and (millimeters)

*Brazed-lead assembly is covered by Patent No. 3,930,306 of 1976 and glass composition by Patent No. 3,752,701 of 1973

MECHANICAL DATA

- Case:** One piece glass, hermetically sealed
Terminals: Plated Axial leads, solderable per MIL-STD-202, Method 208
Polarity: Color band denotes cathode
Mounting Position: Any
Weight: .037 ounce, 1.04 grams

MAXIMUM RATINGS AND ELECTRICAL CHARACTERISTICS

Ratings at 25°C ambient temperature unless otherwise specified.
 Single phase, half wave, 60Hz, resistive or inductive load.
 For capacitive load, derate current by 20%.

	SYMBOLS	1N5550	1N5551	1N5552	1N5553	1N5554	UNITS
*Maximum Recurrent Peak Reverse Voltage	V_{RRM}	200	400	600	800	1000	Volts
Maximum RMS Voltage	V_{RMS}	140	280	420	560	700	Volts
*Maximum DC Blocking Voltage	V_{DC}	200	400	600	800	1000	Volts
*Minimum Reverse Breakdown Voltage at 50 μ A	V_{BR}	240	460	660	880	1100	Volts
*Maximum Average Forward Rectified Current .375", (9.5mm) Lead Lengths at $T_A = 55^\circ\text{C}$	$I_{(AV)}$	3.0					Amps
Peak Forward Surge Current 8.3ms single half sine-wave superimposed on rated load (JEDEC Method)	I_{FSM}	100					Amps
* Maximum Instantaneous Forward Voltage at 3.0A	V_F	1.0			1.1		Volts
*Maximum DC Reverse Current $T_A = 25^\circ\text{C}$ at Rated DC Blocking Voltage $T_A = 100^\circ\text{C}$ $T_A = 200^\circ\text{C}$	I_R	1.0			25.0		μ A
*Maximum Junction Capacitance (Note 2)	C_J	150	120	100	90	85	pf
*Maximum Reverse Recovery Time (Note 1) $T_J = 25^\circ\text{C}$	T_{RR}	2.0			4.0		μ s
Typical Thermal Resistance (Note 4)	$R_{\theta JA}$	15.0					$^\circ\text{C/W}$
*Operating and Storage Temperature Range	$T_{J,STG}$	-65 to +200					$^\circ\text{C}$

NOTES:

1. Reverse Recovery Test Conditions : $I_F = 0.5A$, $I_R = 1.0A$, $I_{rr} = 25A$.
 2. Measured at 1 MHz and applied reverse voltage of 12.0 volts.
 3. Available to JAN and JAN TX Military Specifications MIL-ST-19500/420A.
 4. Thermal Resistance from Junction to Ambient at .375" (9.5mm) Lead Lengths, with both leads mounted between heat sinks.
- *JEDEC Registered Values

RATINGS AND CHARACTERISTIC CURVES 1N5550 THRU 1N5554

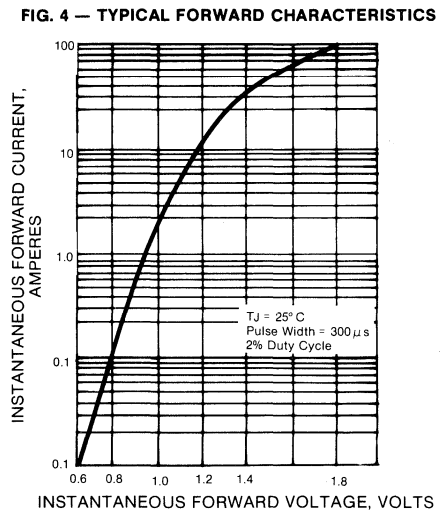
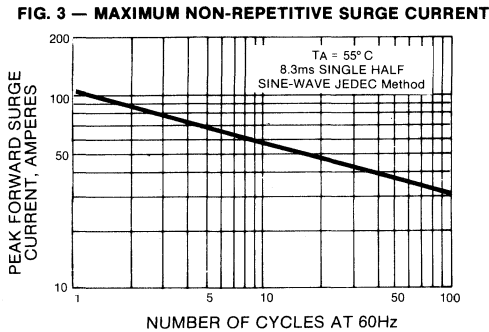
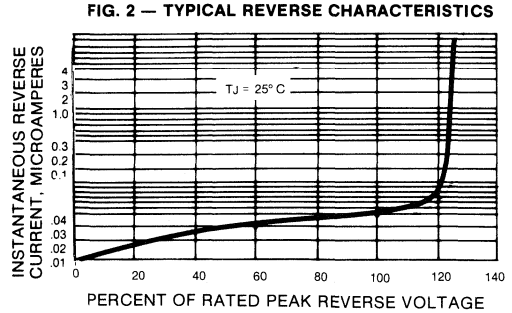
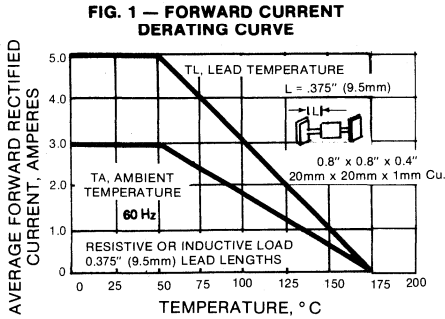
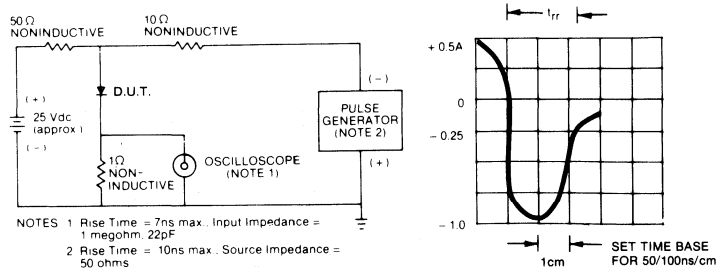

FIG. 5 — REVERSE RECOVERY TIME CHARACTERISTIC AND TEST CIRCUIT DIAGRAM



1N5624 THRU 1N5627

GLASS PASSIVATED SILICON RECTIFIER
Voltage - 200 to 800 Volts Current - 3.0 Amperes

FEATURES

PATENTED*

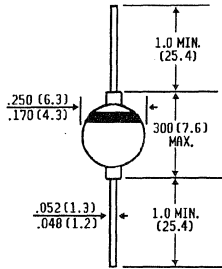

Dimensions in inches
and
(millimeters)

*Brazed-lead assembly is covered by Patent No. 3,930,306 of 1976 and glass composition by Patent No. 3,752,701 of 1973

- ◆ Glass passivated cavity-free junction
- ◆ High temperature metallurgically bonded constructed rectifiers
- ◆ Hermetically sealed package
- ◆ Capable of meeting environmental standards of MIL-S-19500
- ◆ Typical I_R less than $0.1 \mu A$
- ◆ 3.0 Ampere operation at $T_A = 70^\circ C$ with no thermal runaway
- ◆ High temperature soldering guaranteed: $350^\circ C/10$ seconds/.375", (9.5mm) lead length at 5 lbs., (2.3kg) tension

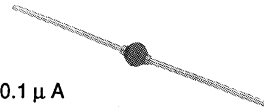

MECHANICAL DATA

- Case:** One piece glass, hermetically sealed
Terminals: Plated Axial leads, solderable per MIL-STD-202, Method 208
Polarity: Color band denotes cathode
Mounting Position: Any
Weight: .04 ounce, 1.1 grams

MAXIMUM RATINGS AND ELECTRICAL CHARACTERISTICS

Ratings at $25^\circ C$ ambient temperature unless otherwise specified.
 Single phase, half wave, 60Hz, resistive or inductive load.
 For capacitive load, derate current by 20%.

	SYMBOLS	1N5624	1N5625	1N5626	1N5627	UNITS
*Maximum Recurrent Peak Reverse Voltage	V_{RRM}	200	400	600	800	Volts
Maximum RMS Voltage	V_{RMS}	140	280	420	560	Volts
*Maximum DC Blocking Voltage	V_{DC}	200	400	600	800	Volts
*Maximum Average Forward Rectified Current .375", (9.5mm) Lead Lengths at $T_A = 70^\circ C$	$I_{(AV)}$	3.0				Amps
Peak Forward Surge Current 8.3ms single half sine-wave superimposed on rated load (JEDEC Method)	I_{FSM}	125				Amps
Maximum Instantaneous Forward Voltage at 3.0A* $T_A = 25^\circ C$ $T_A = 70^\circ C$	V_F	1.0 .95				Volts
*Maximum Reverse Current at Rated DC Blocking Voltage $T_A = 25^\circ C$ $T_A = 175^\circ C$	I_R	300		200		μA
*Maximum Full Load Reverse Current, Full cycle Average, .375", (9.5mm) lead length at $T_A = 70^\circ C$	$I_{R(AV)}$	150		100		μA
Typical Junction Capacitance (Note 1)	C_J	40.0				pf
Typical Thermal Resistance (Note 3)	$R_{\theta JA}$	15.0				$^\circ C/W$
*Operating Temperature Range	T_J	-65 to +175				$^\circ C$
*Storage Temperature Range	T_{STG}	-65 to +200				$^\circ C$

NOTES: 1. Measured at 1.0 MHz and applied reverse voltage of 4.0 Vpc.
 2. Available to JAN and JAN TX Military Specifications MIL-S-19500/432.
 3. Thermal Resistance from Junction to Ambient at .375" (9.5mm) Lead Lengths, with both leads attached between heatsinks.
 *JEDEC Registered Values

RATING AND CHARACTERISTIC CURVES 1N5624 THRU 1N5627

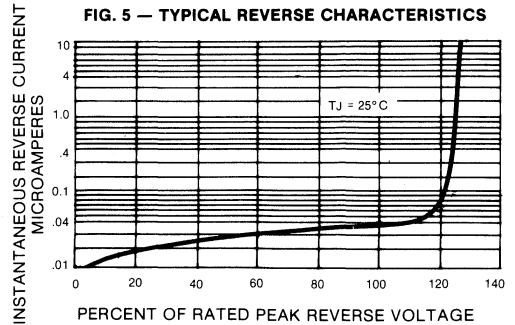
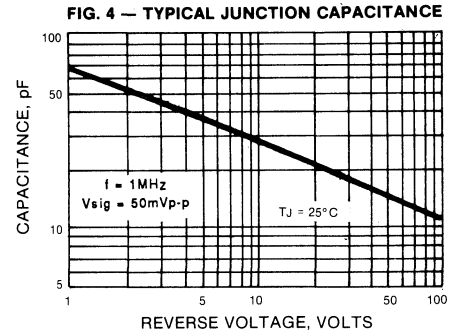
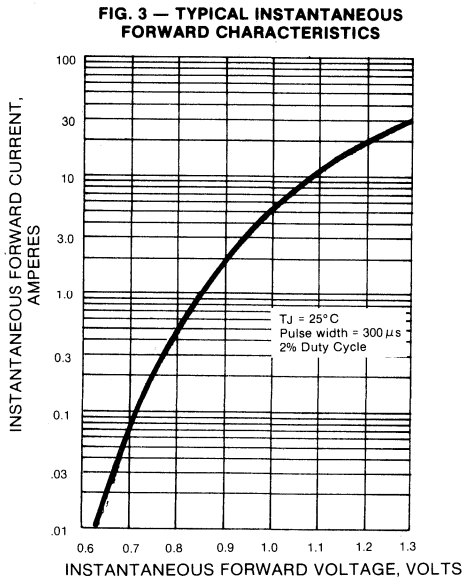
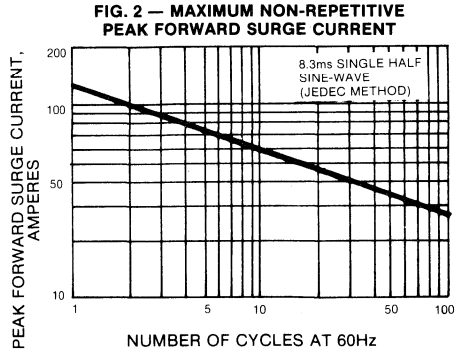
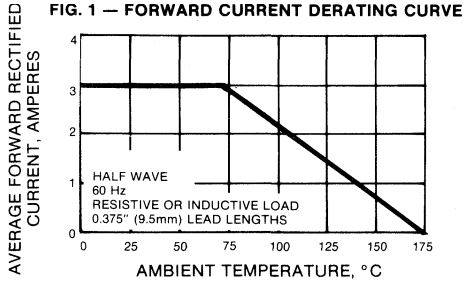

GENERAL INSTRUMENT

G3A THRU G3M

GLASS PASSIVATED SILICION RECTIFIER
Voltage - 50 to 1000 Volts Current- 3.0 Amperes

FEATURES

- ◆ High temperature metallurgically bonded constructed rectifiers
- ◆ Glass passivated cavity-free junction in sealed package
- ◆ 3.0 Ampere operation at $T_A = 70^\circ\text{C}$ with no thermal runaway
- ◆ Typical I_R less than $0.1 \mu\text{A}$
- ◆ Capable of meeting environmental standards of MIL-S-19500
- ◆ High temperature soldering guaranteed: $350^\circ\text{C}/10$ seconds/.375", (9.5mm) lead length at 5 lbs., (2.3kg) tension

PATENTED*

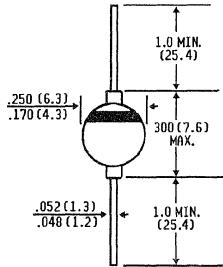

Dimensions in inches
and
(millimeters)

* Brazed-lead assembly is covered by Patent No. 3,930,306 of 1976 and glass composition by Patent No. 3,752,701 of 1973

MECHANICAL DATA

Case: One piece glass, hermetically sealed
Terminals: Plated Axial leads, solderable per MIL-STD-202, Method 208
Polarity: Color band denotes cathode
Mounting Position: Any
Weight: .04 ounce, 1.1 gram

MAXIMUM RATINGS AND ELECTRICAL CHARACTERISTICS

Ratings at 25°C ambient temperature unless otherwise specified.
 Single phase, half wave, 60Hz, resistive or inductive load.
 For capacitive load, derate current by 20%

	SYMBOLS	G3A	G3B	G3D	G3G	G3J	G3K	G3M	UNITS
Maximum Recurrent Peak Reverse Voltage	V_{RRM}	50	100	200	400	600	800	1000	Volts
Maximum RMS Voltage	V_{RMS}	35	70	140	280	420	560	700	Volts
Maximum DC Blocking Voltage	V_{DC}	50	100	200	400	600	800	1000	Volts
Maximum Average Forward Rectified Current, .375" (9.5mm) Lead Length at $T_A = 70^\circ\text{C}$	$I_{(AV)}$	3.0							Amps
Peak Forward Surge Current 8.3ms single half sine-wave superimposed on rated load (JEDEC Method)	I_{FSM}	125							Amps
Maximum Instantaneous Forward Voltage at 3.0A	V_F	1.2		1.1					Volts
Maximum Full Load Reverse Current, Full Cycle Average, .375", (9.5mm) Lead Length at $T_A = 70^\circ\text{C}$	$I_{R(AV)}$	200							μA
Maximum DC Reverse Current $T_A = 25^\circ\text{C}$ at Rated DC Blocking Voltage $T_A = 150^\circ\text{C}$	I_R	5.0 100							μA
Typical Reverse Recovery Time (Note 1)	T_{RR}	3.0							μs
Typical Junction Capacitance (Note 2)	C_J	40.0							pf
Typical Thermal Resistance (Note 3)	$R_{\theta JA}$	15.0							$^\circ\text{C/W}$
Operating and Storage Temperature Range	T_J, T_{STG}	-65 to +175							$^\circ\text{C}$

NOTES:

1. Measured with $I_F = .5\text{A}$, $I_R = 1\text{A}$, $I_{rr} = .25\text{A}$.
2. Measured at 1.0 MHz and applied reverse voltage of 4.0 V_{DC} .
3. Thermal Resistance from Junction to Ambient at .375" (9.5mm) Lead Lengths, with both leads mounted between heatsinks.

RATINGS AND CHARACTERISTIC CURVES G3A THRU G3M

FIG. 1 — FORWARD CURRENT DERATING CURVE

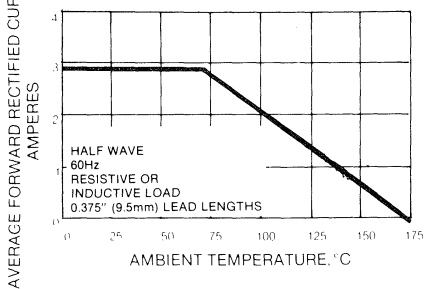

FIG. 3 — TYPICAL INSTANTANEOUS FORWARD CHARACTERISTICS

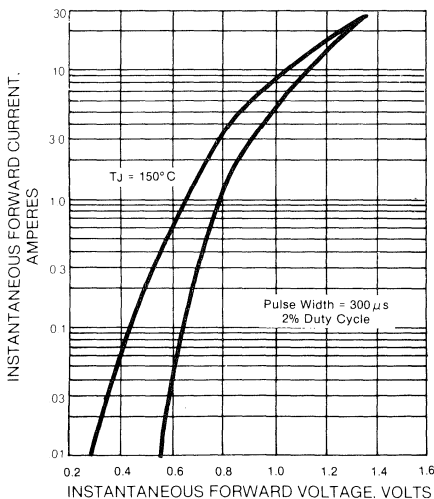

FIG. 2 — MAXIMUM NON-REPETITIVE PEAK FORWARD SURGE CURRENT

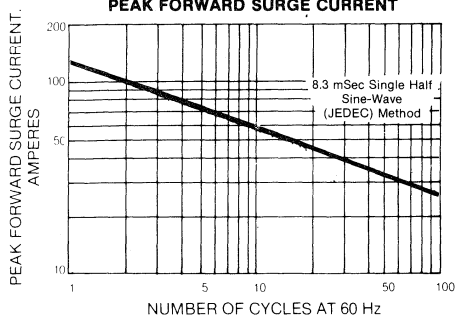

FIG. 4 — TYPICAL JUNCTION CAPACITANCE

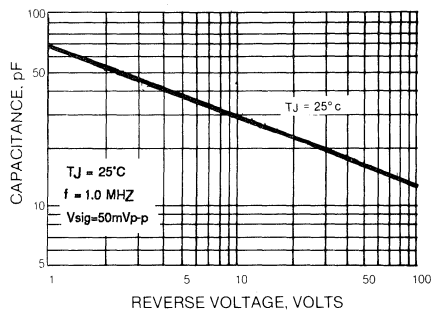
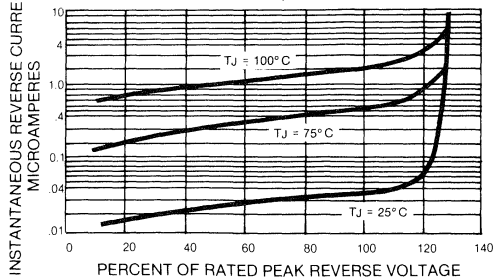

FIG. 5 — TYPICAL REVERSE CHARACTERISTICS



G4A THRU G4M

GLASS PASSIVATED SILICON RECTIFIER
Voltage - 50 to 1000 Volts Current- 3.0 Amperes

FEATURES

PATENTED*

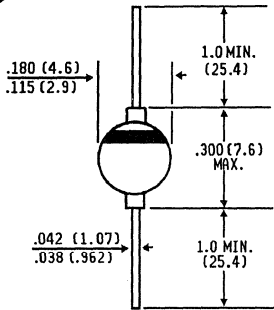

Dimensions in inches
and
(millimeters)

* Brazed-lead assembly is covered by Patent No. 3,930,306 of 1976 and glass composition by Patent No.3,752,701 of 1973

- ◆ High temperature metallurgically bonded constructed rectifiers
- ◆ Glass passivated cavity-free junction in sealed package
- ◆ 3.0 Ampere operation at $T_A = 70^\circ\text{C}$ with no thermal runaway
- ◆ Typical I_R less than $0.1 \mu\text{A}$
- ◆ Capable of meeting environmental standards of MIL-S-19500
- ◆ High temperature soldering guaranteed: $350^\circ\text{C}/10$ seconds/.375", (9.5mm) lead length at 5 lbs., (2.3kg) tension

MECHANICAL DATA

Case: One piece glass, hermetically sealed

Terminals: Plated Axial leads, solderable per MIL-STD-202, Method 208

Polarity: Color band denotes cathode

Mounting Position: Any

Weight: .037 ounce, 1.04 grams

MAXIMUM RATINGS AND ELECTRICAL CHARACTERISTICS

Ratings at 25°C ambient temperature unless otherwise specified.
 Single phase, half wave, 60Hz, resistive or inductive load.
 For capacitive load, derate current by 20%

	SYMBOLS	G4A	G4B	G4D	G4G	G4J	G4K	G4M	UNITS
Maximum Recurrent Peak Reverse Voltage	V_{RRM}	50	100	200	400	600	800	1000	Volts
Maximum RMS Voltage	V_{RMS}	35	70	140	280	420	560	700	Volts
Maximum DC Blocking Voltage	V_{DC}	50	100	200	400	600	800	1000	Volts
Maximum Average Forward Rectified Current, .375" (9.5mm) Lead Length at $T_A = 70^\circ\text{C}$	$I_{(AV)}$	3.0							Amps
Peak Forward Surge Current 8.3ms single half sine-wave superimposed on rated load (JEDEC Method)	I_{FSM}	100							Amps
Maximum Instantaneous Forward Voltage at 3.0A	V_F	1.1							Volts
Maximum Full Load Reverse Current Full Cycle Average, .375", (9.5mm) Lead Length at $T_A = 70^\circ\text{C}$	$I_{R(AV)}$	200							μA
Maximum Average Reverse Current at Peak Reverse Voltage $T_A = 25^\circ\text{C}$ $T_A = 100^\circ\text{C}$	$I_{R(AV)}$	5.0 100							μA
Maximum DC Reverse Current at Rated DC Blocking Voltage $T_A = 25^\circ\text{C}$ $T_A = 100^\circ\text{C}$	I_R	1.0 100							μA
Typical Reverse Recovery Time (Note 2) $T_J = 25^\circ\text{C}$	T_{RR}	3.0							μs
Typical Junction Capacitance (Note 1)	C_J	40.0							pf
Typical Thermal Resistance (Note 3)	$R_{\theta JA}$	15.0							$^\circ\text{C}/\text{W}$
Operating and Storage Temperature Range	T_J, T_{STG}	-65 to +175							$^\circ\text{C}$

NOTES:

1. Measured at 1 MHz and applied reverse voltage of 4.0 Volts.
2. Reverse Recovery Test Conditions: $I_F = 0.5\text{A}$, $I_R = 1.0\text{A}$, $I_{rr} = .25\text{A}$.
3. Thermal Resistance from Junction to Ambient at .375" (9.5mm) Lead Lengths with both leads mounted between heatsinks..

RATINGS AND CHARACTERISTIC CURVES G4A THRU G4M

Fig. 1—FORWARD CURRENT DERATING CURVE

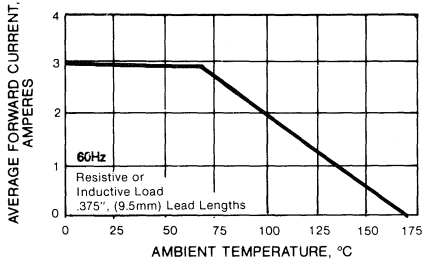

Fig. 3—TYPICAL INSTANTANEOUS FORWARD CHARACTERISTICS

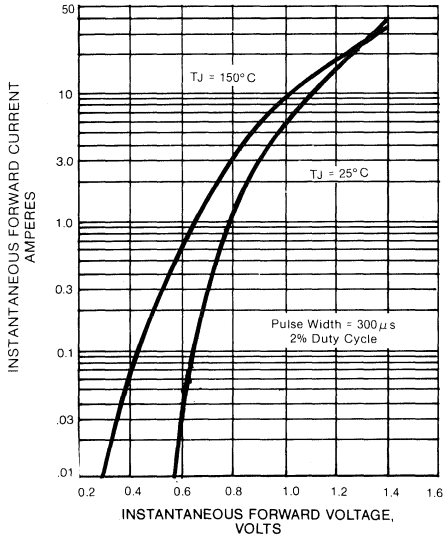

FIG. 2 — MAXIMUM NON-REPETITIVE PEAK FORWARD SURGE CURRENT

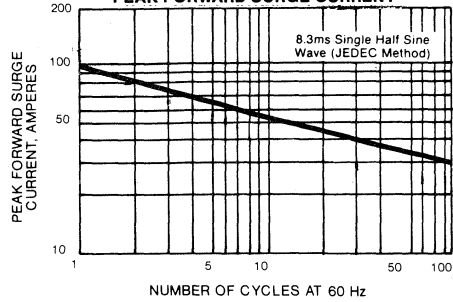

Fig. 4—TYPICAL JUNCTION CAPACITANCE

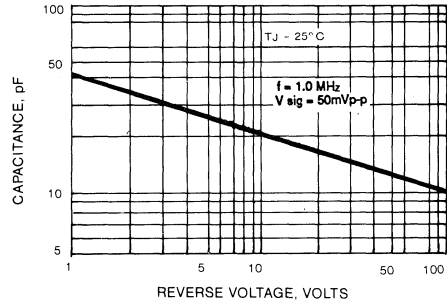
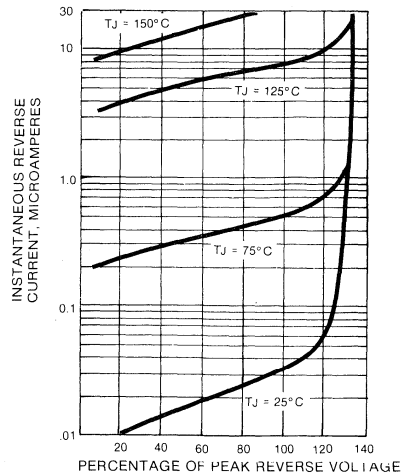

FIG. 5 — TYPICAL REVERSE CHARACTERISTICS



**HIGH VOLTAGE GLASS
PASSIVATED RECTIFIERS**

***1.0 AMPERE TO 3.0 AMPERES
1200 VOLTS TO 1600 VOLTS***

**GENERAL
INSTRUMENT**

CG1 AND DG1

MINIATURE CLAMPER / DAMPER GLASS PASSIVATED JUNCTION SILICON RECTIFIER

Voltage - 1400 to 1500 Volts Current - 1.5 Amperes

FEATURES

PATENTED*

DO-204AP

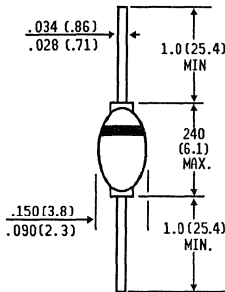

Dimensions in inches
and
(millimeters)

- ◆ Specially designed for clamping circuits horizontal deflection systems and damper applications
- ◆ High temperature metallurgically bonded constructed rectifiers
- ◆ Glass passivated cavity-free junction in DO-204AP package
- ◆ 1.5 Ampere operation at $T_A = 50^\circ\text{C}$ with no thermal runaway
- ◆ Typical I_R less than $0.1 \mu\text{A}$
- ◆ Hermetically sealed package
- ◆ Capable of meeting environmental standards of MIL-S-19500
- ◆ High temperature soldering guaranteed: $350^\circ\text{C}/10$ seconds/.375", (9.5mm) lead length at 5 lbs., (2.3kg) tension

MECHANICAL DATA

Case: One piece glass, hermetically sealed
Terminals: Plated Axial leads, solderable per MIL-STD-202, Method 208
Polarity: Color band denotes cathode
Mounting Position: Any
Weight: .02 ounce, .56 grams

* Brazed-lead assembly is covered by Patent No. 3,930,306 of 1976 and glass composition by Patent No. 3,752,701 of 1973

MAXIMUM RATINGS AND ELECTRICAL CHARACTERISTICS

Ratings at 25°C ambient temperature unless otherwise specified.
60 Hz, resistive or inductive load. For capacitive load, derate current by 20%.

	SYMBOLS	CG1	DG1	UNITS
Maximum Recurrent Peak Reverse Voltage	V_{RRM}	1400	1500	Volts
Maximum RMS Voltage	V_{RMS}	980	1050	Volts
Maximum DC Blocking Voltage	V_{DC}	1400	1500	Volts
Maximum Average Forward Rectified Current .375", (9.5mm) Lead Lengths at $T_A = 50^\circ\text{C}$	$I_{(AV)}$	1.5		Amps
Peak Forward Surge Current 8.3ms single half sine -wave superimposed on rated load (JEDEC Method)	I_{FSM}	40.0		Amps
Maximum Instantaneous Forward Voltage at 1.0A	V_F	1.1		Volts
Maximum DC Reverse Current $T_A = 25^\circ\text{C}$ at Rated DC Blocking Voltage $T_A = 100^\circ\text{C}$	I_R	100		μA
Maximum Full Load Reverse Current Full Cycle Average, .375", (9.5mm) Lead Length $T_A = 100^\circ\text{C}$	$I_{R(AV)}$	50.0		μA
Maximum Reverse Recovery Time (Note 1) $T_J = 25^\circ\text{C}$	T_{RR}	15.0	20.0	μs
Typical Junction Capacitance (Note 2)	C_J	15.0		pf
Typical Thermal Resistance (Note 3)	$R_{\theta JA}$	40.0		$^\circ\text{C}/\text{W}$
Operating Storage Temperature Range	T_J, T_{STG}	-65 to +175		$^\circ\text{C}$

NOTES:

1. Reverse Recovery Test Conditions : $I_F = 0.5\text{A}$, $I_R = 50\text{ma}$.
2. Measured at 1 MHz and applied reverse voltage of $4.0 V_{DC}$.
3. Thermal Resistance from Junction to Ambient at .375" (9.5mm) Lead Lengths, P.C. Board Mounted.

RATINGS AND CHARACTERISTIC CURVES CG1 AND DG1

FIG. 1 — FORWARD CURRENT DERATING CURVE

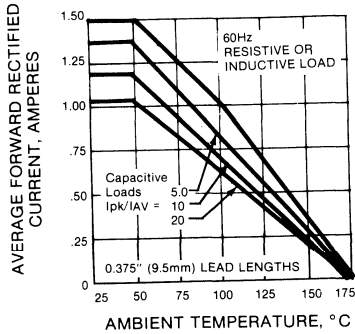

FIG. 3 — TYPICAL INSTANTANEOUS FORWARD CHARACTERISTICS

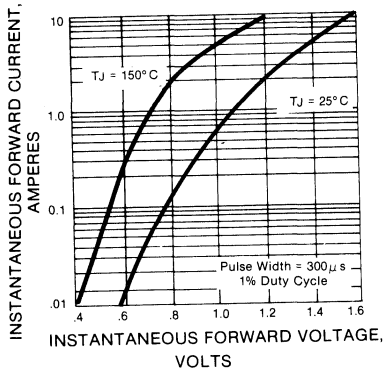

FIG. 6 — REVERSE RECOVERY TIME CHARACTERISTIC AND TEST DIAGRAM

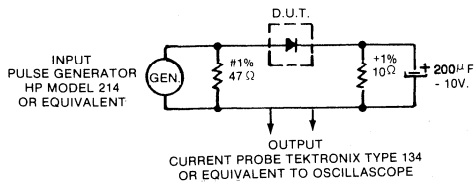

FIG. 2 — MAXIMUM NON REPETITIVE PEAK FORWARD SURGE CURRENT

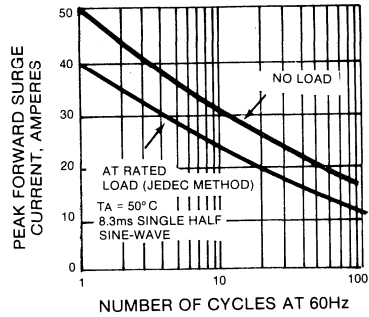

FIG. 4 — TYPICAL JUNCTION CAPACITANCE

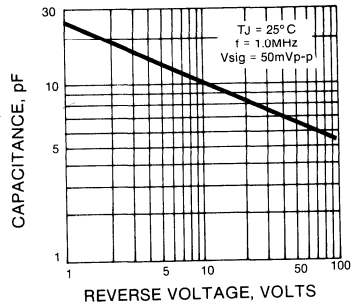
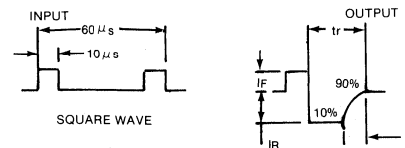
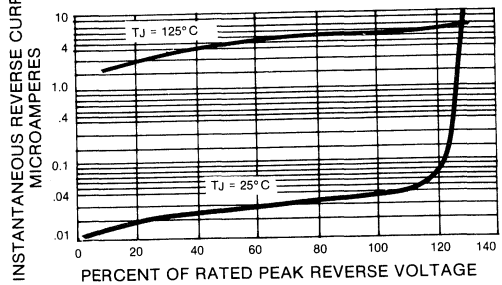

FIG. 5 — TYPICAL REVERSE CHARACTERISTICS



GI1-1200 THRU GI1-1600

MINIATURE GLASS PASSIVATED JUNCTION SILICON RECTIFIER

Voltage - 1200 to 1600 Volts Current - 1.0 Ampere

FEATURES

- ◆ High temperature metallurgically bonded constructed rectifiers
- ◆ Glass passivated cavity-free junction in D0-204AP package
- ◆ 1.0 Ampere operation at $T_A = 75^\circ\text{C}$ with no thermal runaway
- ◆ Typical I_R less than $0.1 \mu\text{A}$
- ◆ Hermetically sealed package
- ◆ Capable of meeting environmental standards of MIL-S-19500
- ◆ High temperature soldering guaranteed: $350^\circ\text{C}/10$ seconds/.375", (9.5mm) lead length at 5 lbs., (2.3kg) tension

PATENTED*

DO-204AP

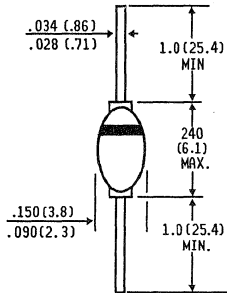

Dimensions in inches and (millimeters)

MECHANICAL DATA

- Case:** One piece glass, hermetically sealed
Terminals: Plated Axial leads, solderable per MIL-STD-202, Method 208
Polarity: Color band denotes cathode
Mounting Position: Any
Weight: .02 ounce, .56 grams

* Brazed-lead assembly is covered by Patent No. 3,930,306 of 1976 and glass composition by Patent No. 3,752,701 of 1973

MAXIMUM RATINGS AND ELECTRICAL CHARACTERISTICS

Ratings at 25°C ambient temperature unless otherwise specified.
 60 Hz Resistive or inductive load. For capacitive load, derate current by 20%.

	SYMBOLS	GI1-1200	GI1-1400	GI1-1600	UNITS
Maximum Recurrent Peak Reverse Voltage	V_{RRM}	1200	1400	1600	Volts
Maximum RMS Voltage	V_{RMS}	840	980	1120	Volts
Maximum DC Blocking Voltage	V_{DC}	1200	1400	1600	Volts
Maximum Average Forward Rectified Current .375", (9.5mm) Lead Lengths at $T_A = 75^\circ\text{C}$	$I_{(AV)}$	1.0			Amps
Peak Forward Surge Current 8.3ms single half sine wave superimposed on rated load (JEDEC Method)	I_{FSM}	30.0			Amps
Maximum Instantaneous Forward Voltage at 1.0A 3.14A	V_F	1.1 1.3			Volts
Maximum DC Reverse Current $T_A = 25^\circ\text{C}$ at Rated DC Blocking Voltage $T_A = 100^\circ\text{C}$	I_R	10.0 100			μA
Maximum Reverse Recovery Time (Note 1)	T_{RR}	25.0			μs
Maximum Forward Recovery Time (Note 2)	T_{FR}	1.0			μs
Typical Junction Capacitance (Note 3)	C_J	15.0			pf
Typical Thermal Resistance (Note 4)	$R_{\theta JA}$	40.0			$^\circ\text{C}/\text{W}$
Operating Storage Temperature Range	T_J, T_{STG}	-65 to +175			$^\circ\text{C}$

NOTES:

1. Measured on Tektronix Type "S" recovery plug-in Tektronix 545 Scope or equivalent IFM = 20 mA, IRM = 2mA.
2. Measured on Tektronix Type "S" recovery plug-in, Tektronix 545 or equivalent, IFM = 20mA.
3. Measured at 1 MHz and applied reverse voltage of $4.0 V_{DC}$.
4. Thermal Resistance from Junction to Ambient at .375" (9.5mm) Lead Lengths, P.C. Board Mounted.

RATINGS AND CHARACTERISTIC CURVES GI1-1200 THRU GI1-1600

FIG. 1 — FORWARD CURRENT DERATING CURVE

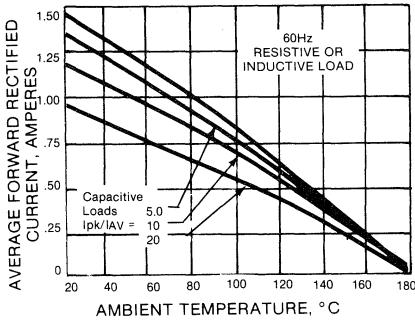

FIG. 2 — MAXIMUM NON REPETITIVE PEAK FORWARD SURGE CURRENT

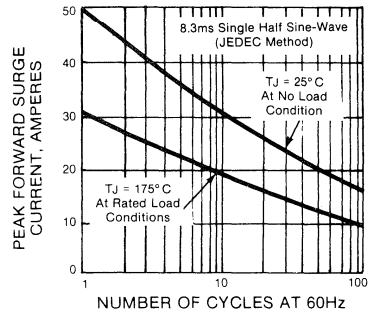

FIG. 3 — TYPICAL INSTANTANEOUS FORWARD CHARACTERISTICS

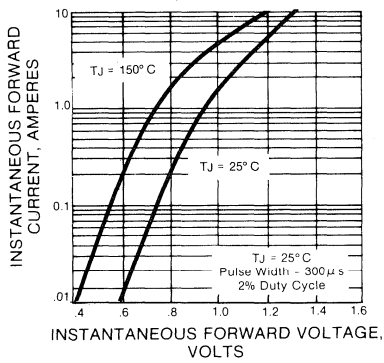

FIG. 4 — TYPICAL JUNCTION CAPACITANCE

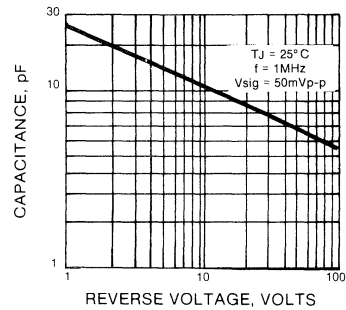
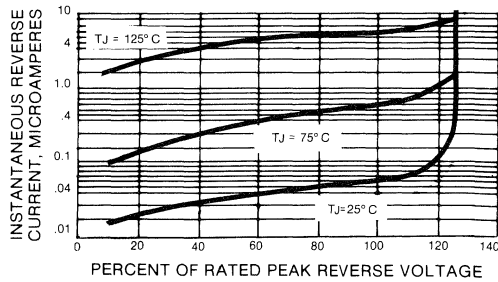

FIG. 5 — TYPICAL REVERSE CHARACTERISTICS



BY448 AND BY458

MINIATURE GLASS PASSIVATED JUNCTION CLAMPER / DAMPER SILICON RECTIFIER

Voltage - 1200 to 1500 Volts Current - 1.5 Amperes

GENERAL DESCRIPTION

These silicon Glass Passivated Clamper / Damper Rectifiers are designed for TV Applications such as clamping circuits in horizontal deflection systems and damper applications.

The glass passivated construction and Dual Heat - Sink design assures reliable and stable operation.

FEATURES

- ◆ High temperature metallurgically bonded constructed rectifiers
- ◆ Glass passivated cavity- free junction in DO-204AP package
- ◆ 1.5 Ampere operation at $T_A = 50^\circ\text{C}$ with no thermal runaway
- ◆ Typical I_R less than $0.1 \mu\text{A}$
- ◆ Hermetically sealed package
- ◆ Capable of meeting environmental standards of MIL-S-19500
- ◆ High temperature soldering guaranteed: $350^\circ\text{C}/10$ seconds/.375", (9.5mm) lead length at 5 lbs., (2.3kg) tension

MECHANICAL DATA

Case: One piece glass, hermetically sealed
Terminals: Plated Axial leads, solderable per MIL-STD-202, Method 208
Polarity: Color band denotes cathode
Mounting Position: Any **Weight:** .02 ounce, .56 gram

DO-204AP

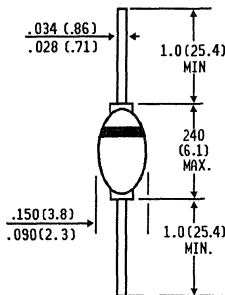

Dimensions in inches and (millimeters)

* Brazed-lead assembly is covered by Patent No. 3,930,306 of 1976 and glass composition by Patent No. 3,752,701 of 1973

MAXIMUM RATINGS AND ELECTRICAL CHARACTERISTICS

Ratings at 25°C ambient temperature unless otherwise specified. Single phase, half wave, 50 - 60 Hz, resistive or inductive load.. For capacitive load, derate current by 20%.

	SYMBOLS	BY458	BY448	UNITS
Maximum Non Recurrent Peak Reverse Voltage	V_{RSM}	1400	1650	Volts
Maximum Recurrent Peak Reverse Voltage	V_{RRM}	1200	1500	Volts
Maximum DC Blocking Voltage	V_{DC}	1200	1500	Volts
Maximum Average Forward Rectified Current .375", (9.5mm) Lead Lengths at $T_A = 50^\circ\text{C}$	$I_{(AV)}$	1.5		Amps
Peak Forward Surge Current 10ms single half sine -wave superimposed on rated load	I_{FSM}	30.0		Amps
Maximum Instantaneous Forward Voltage at 3.0A	V_F	1.6		Volts
Working Peak Forward Current at $T_A = 75^\circ\text{C}$	I_{FWM}	4.0		Amps
Peak Repetitive Forward Current at $T_A = 75^\circ\text{C}$	I_{RFM}	8.0		Amps
Maximum Peak Reverse Current $T_A = 25^\circ\text{C}$ at Rated Peak Reverse Voltage $T_A = 140^\circ\text{C}$	I_R	5.0 200		μA
Maximum Reverse Recovery Time (Note 1) $T_J = 140^\circ\text{C}$	T_{RR}	20.0		μs
Typical Junction Capacitance (Note 2)	C_J	15.0		pf
Typical Thermal Resistance (Note 3)	$R_{\theta JA}$	40.0		$^\circ\text{C}/\text{W}$
Operating Temperature Range	T_J	-65 to +150		$^\circ\text{C}$
Storage Temperature Range	T_{STG}	-65 to +200		$^\circ\text{C}$

NOTES: 1. Measured with $I_F = 0.5\text{A}$, $I_R = 50\text{ma}$. 2. Measured at 1 MHz and applied reverse voltage of 4.0 Vdc.
 3. Thermal Resistance from Junction to Ambient at .375" (9.5mm) Lead Lengths, P.C. Board Mounted.

RATINGS AND CHARACTERISTIC CURVES BY448 AND BY458

FIG. 1 — FORWARD CURRENT DERATING CURVE

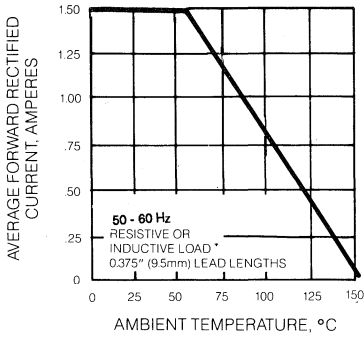

FIG. 2 — MAXIMUM NON REPETITIVE PEAK FORWARD SURGE CURRENT

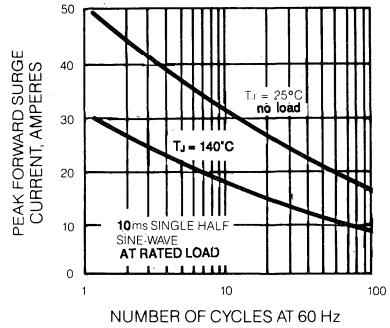

FIG. 4 — TYPICAL JUNCTION CAPACITANCE

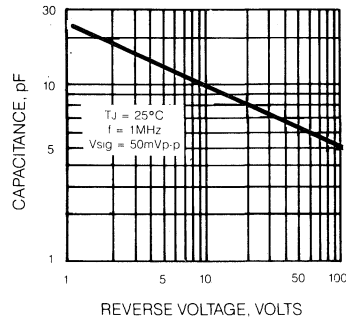

FIG. 3 — TYPICAL INSTANTANEOUS FORWARD CHARACTERISTICS

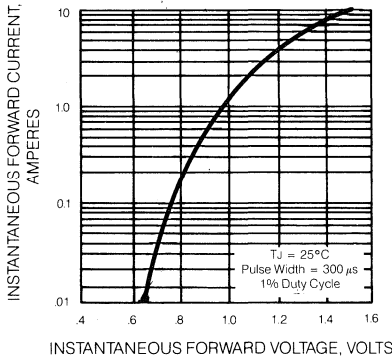

FIG. 5 — TYPICAL REVERSE CHARACTERISTICS

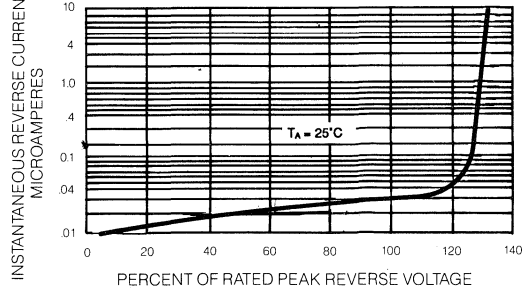
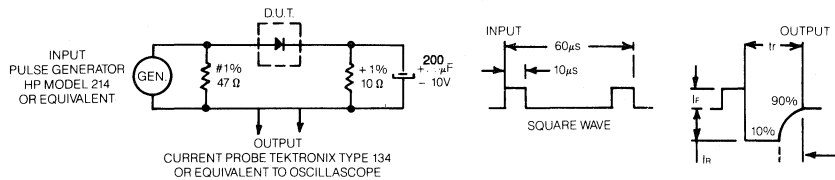

FIG. 6 — REVERSE RECOVERY TIME CHARACTERISTIC AND TEST DIAGRAM



GENERAL INSTRUMENT

CG2 AND DG2

MINIATURE CLAMPER / DAMPER GLASS PASSIVATED JUNCTION SILICON RECTIFIER

Voltage - 1400 to 1500 Volts Current - 2.0 Amperes

FEATURES

- ◆ Specially designed for clamping circuits in horizontal deflection systems and damper applications
- ◆ High temperature metallurgically bonded
- ◆ Glass passivated cavity-free junction in a DO-204AP package
- ◆ 2.0 Ampere operation at $T_A = 50^\circ\text{C}$ with no thermal runaway
- ◆ Typical I_R less than $0.1 \mu\text{A}$
- ◆ Hermetically sealed package
- ◆ Capable of meeting environmental standards of MIL-S-19500
- ◆ High temperature soldering guaranteed: $350^\circ\text{C}/10$ seconds/.375", (9.5mm) lead length at 5 lbs., (2.3kg) tension

PATENTED*

DO-204AP

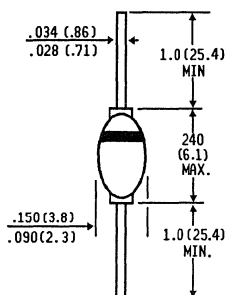

Dimensions in inches
and
(millimeters)

* Brazed-lead assembly is covered by Patent No. 3,930,306 of 1976 and glass composition by Patent No. 3,752,701 of 1973

MECHANICAL DATA

Case: One piece glass, hermetically sealed

Terminals: Plated Axial leads, solderable per MIL-STD-202, Method 208

Polarity: Color band denotes cathode

Mounting Position: Any

Weight: .02 ounce, .56 grams

MAXIMUM RATINGS AND ELECTRICAL CHARACTERISTICS

Ratings at 25°C ambient temperature unless otherwise specified.
60 Hz, resistive or inductive load. For capacitive load, derate current by 20%.

	SYMBOLS	CG2	DG2	UNITS
Maximum Recurrent Peak Reverse Voltage	V_{RRM}	1400	1500	Volts
Maximum RMS Voltage	V_{RMS}	980	1050	Volts
Maximum DC Blocking Voltage	V_{DC}	1400	1500	Volts
Maximum Average Forward Rectified Current .375", (9.5mm) Lead Lengths at $T_A = 50^\circ\text{C}$	$I_{(AV)}$	2.0		Amps
Peak Forward Surge Current 8.3ms single half sine -wave superimposed on rated load (JEDEC Method)	I_{FSM}	40.0		Amps
Maximum Instantaneous Forward Voltage at 2.0A	V_F	1.1		Volts
Maximum DC Reverse Current $T_A = 25^\circ\text{C}$ at Rated DC Blocking Voltage $T_A = 100^\circ\text{C}$	I_R	5.0 100		μA
Maximum Full Load Reverse Current Full Cycle Average, .375", (9.5mm) Lead Length $T_A = 100^\circ\text{C}$	$I_{R(AV)}$	200		μA
Maximum Reverse Recovery Time (Note 1) $T_J = 25^\circ\text{C}$	T_{RR}	15.0	20.0	μs
Typical Junction Capacitance (Note 2)	C_J	15.0		pf
Typical Thermal Resistance (Note 3)	$R_{\theta JA}$	40.0		$^\circ\text{C}/\text{W}$
Operating Storage Temperature Range	T_J, T_{STG}	-65 to +175		$^\circ\text{C}$

NOTES:

1. Measured with $I_F = 0.5\text{A}$, $I_R = 50\text{mA}$.
2. Measured at 1 MHz and applied reverse voltage of 4.0 V_{DC}.
3. Thermal Resistance from Junction to Ambient at .375" (9.5mm) Lead Lengths, P.C. Board Mounted.

RATINGS AND CHARACTERISTIC CURVES CG2 AND DG2

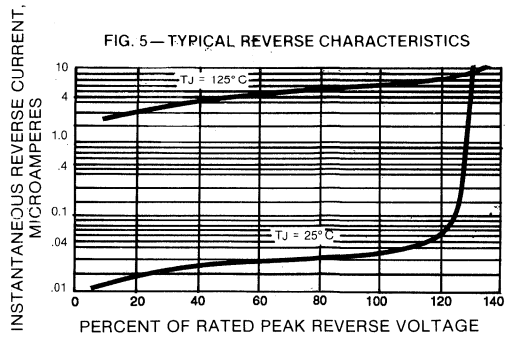
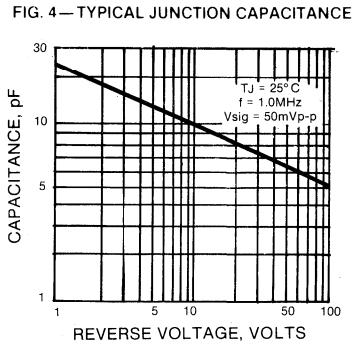
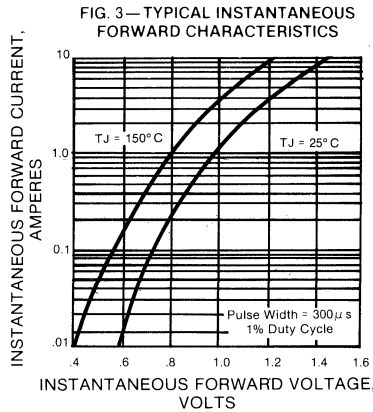
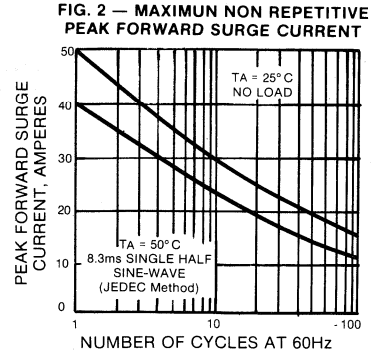
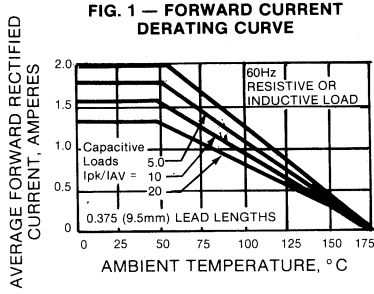
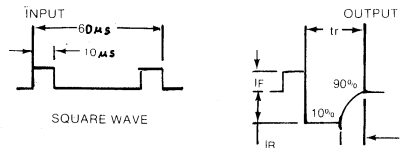
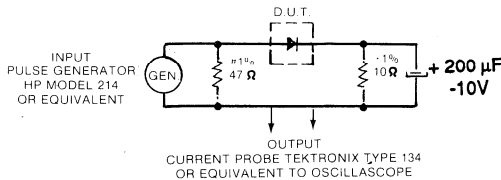

FIG. 6 — REVERSE RECOVERY TIME CHARACTERISTIC AND TEST DIAGRAM



BY228 SERIES

GLASS PASSIVATED JUNCTION CLAMPER / DAMPER SILICON RECTIFIER

Voltage - 1500 Volts Current - 2.5 Amperes

GENERAL DESCRIPTION

These silicon Glass Passivated Clamper / Damper Rectifiers are designed for TV Applications, such as clamping circuits in horizontal deflection systems and damper

applications. The glass passivated construction and Dual Heat - Sink design assures reliable and stable operation.

FEATURES

- ◆ High temperature metallurgically bonded constructed rectifiers
- ◆ Glass passivated cavity-free junction
- ◆ 2.5 Ampere operation at $T_A = 50^\circ\text{C}$ with no thermal runaway
- ◆ Typical I_R less than $0.1 \mu\text{A}$
- ◆ Hermetically sealed package
- ◆ Capable of meeting environmental standards of MIL-S-19500
- ◆ High temperature soldering guaranteed: $350^\circ\text{C}/10$ seconds/.375", (9.5mm) lead length at 5 lbs., (2.3kg) tension

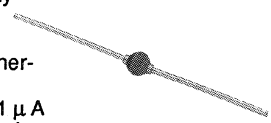

PATENTED*

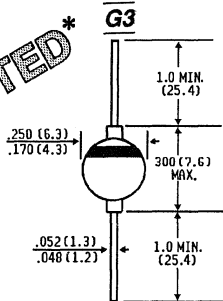

Dimensions in inches
and
(millimeters)

MECHANICAL DATA

Case: One piece glass, hermetically sealed

Terminals: Axial leads, solderable per MIL-STD-202, Method 208

Polarity: Color band denotes cathode

Mounting Position: Any **Weight:** .04 ounce, 1.1 gram

MAXIMUM RATINGS AND ELECTRICAL CHARACTERISTICS

Ratings at 25°C ambient temperature unless otherwise specified. Single phase, half wave, 50 - 60 Hz, resistive or inductive load.
For capacitive load, derate current by 20%.

	SYMBOLS	BY228	UNITS
Maximum Non Repetitive Peak Reverse Voltage	V_{RSM}	1650	Volts
Maximum Recurrent Peak Reverse Voltage	V_{RRM}	1500	Volts
Maximum RMS Voltage	V_{RMS}	1050	Volts
Maximum DC Blocking Voltage	V_{DC}	1500	Volts
Maximum Average Forward Rectified Current .375", (9.5mm) Lead Lengths at $T_A = 50^\circ\text{C}$	$I_{(AV)}$	2.5	Amps
Peak Forward Surge Current 10ms single half sine -wave superimposed on rated load	I_{FSM}	50.0	Amps
Maximum Instantaneous Forward Voltage at 5.0A	V_F	1.6	Volts
Working Peak Forward Current at $T_A = 75^\circ\text{C}$	I_{FWM}	5.0	Amps
Peak Repetitive Forward Surge Current at $T_A = 75^\circ\text{C}$	I_{FRM}	10.0	Amps
Maximum Peak Reverse Current $T_A = 25^\circ\text{C}$ at Rated Peak Reverse Voltage $T_J = 140^\circ\text{C}$	I_R	5.0 200	μA
Maximum Reverse Recovery Time (Note 1)	T_{RR}	20.0	μS
Maximum Forward Recovery Time (Note 3)	T_{FR}	1.0	μS
Typical Junction Capacitance (Note 2)	C_J	40.0	pf
Typical Thermal Resistance (Note 4)	$R_{\theta JA}$	20.0	$^\circ\text{C}/\text{W}$
Operating Temperature Range	T_J	-65 to +150	$^\circ\text{C}$
Storage Temperature Range	T_{STG}	-65 to +200	$^\circ\text{C}$

NOTES: 1. Measured with $I_F = 1.0\text{A}$, $I_R = 50\text{mA}$, $di/dt = 50\text{mA}/\mu\text{s}$. 2. Measured at 1 MHz and applied reverse voltage of 4.0 Vdc.
3. Measured with $I_F = 5.0\text{A}$ with $t_r = 0.1 \mu\text{s}$
4. Thermal Resistance from Junction to Ambient at .375" (9.5mm) Lead Lengths, P.C. Board Mounted.

RATING AND CHARACTERISTIC CURVES BY228 SERIES

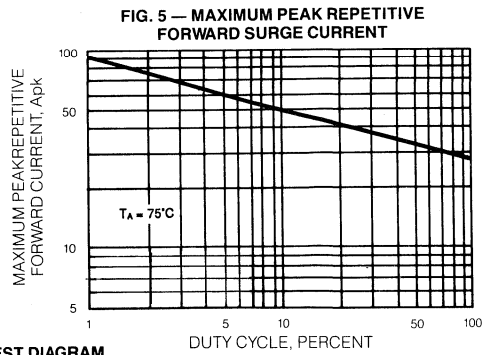
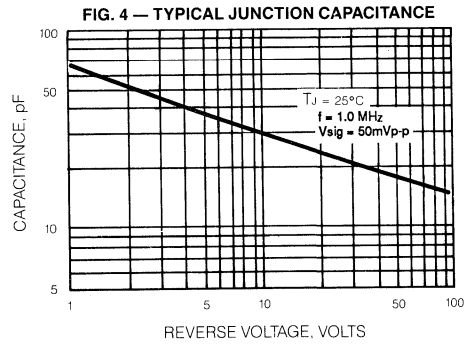
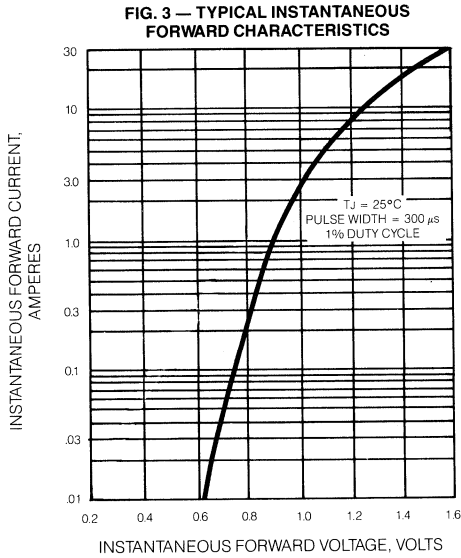
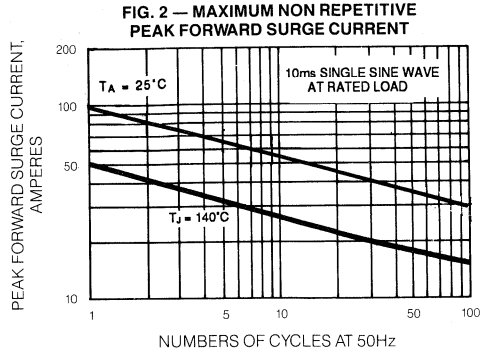
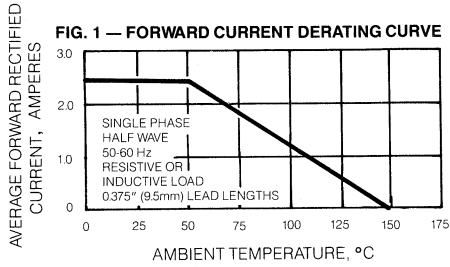
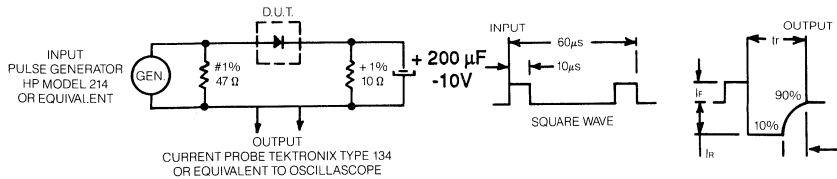

FIG. 6 — REVERSE RECOVERY TIME CHARACTERISTIC AND TEST DIAGRAM



CG3 AND DG3

GLASS PASSIVATED JUNCTION CLAMPER / DAMPER SILICON RECTIFIER

Voltage - 1400 to 1500 Volts **Current - 3.0 Ampere**

FEATURES

- ◆ Specially designed for clamping circuits horizontal deflection systems and damper applications
- ◆ High temperature metallurgically bonded constructed rectifiers
- ◆ Glass passivated cavity-free junction
- ◆ 3.0 Ampere operation at $T_A = 50^\circ\text{C}$ with no thermal runaway
- ◆ Typical I_R less than $0.1 \mu\text{A}$
- ◆ Hermetically sealed package
- ◆ Capable of meeting environmental standards of MIL-S-19500
- ◆ High temperature soldering guaranteed: $350^\circ\text{C}/10$ seconds/.375", (9.5mm) lead length at 5 lbs., (2.3kg) tension

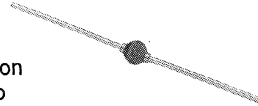

PATENTED*

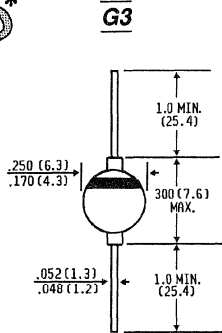

Dimensions in inches
and
(millimeters)

* Brazed-lead assembly is covered by Patent No. 3,930,306 of 1976 and glass composition by Patent No. 3,752,701 of 1973

MECHANICAL DATA

Case: One piece glass, hermetically sealed
Terminals: Plated Axial leads, solderable per MIL-STD-202, Method 208
Polarity: Color band denotes cathode
Mounting Position: Any
Weight: .04 ounce, 1.1 gram

MAXIMUM RATINGS AND ELECTRICAL CHARACTERISTICS

Ratings at 25°C ambient temperature unless otherwise specified.
60 Hz, resistive or inductive load. For capacitive load, derate current by 20%.

	SYMBOLS	CG3	DG3	UNITS
Maximum Recurrent Peak Reverse Voltage	V_{RRM}	1400	1500	Volts
Maximum RMS Voltage	V_{RMS}	980	1050	Volts
Maximum DC Blocking Voltage	V_{DC}	1400	1500	Volts
Maximum Average Forward Rectified Current .375", (9.5mm) Lead Lengths at $T_A = 50^\circ\text{C}$	$I_{(AV)}$	3.0		Amps
Peak Forward Surge Current 8.3ms single half sine -wave superimposed on rated load (JEDEC Method)	I_{FSM}	100		Amps
Maximum Instantaneous Forward Voltage at 3.0A	V_F	1.2		Volts
Maximum DC Reverse Current $T_A = 25^\circ\text{C}$ at Rated DC Blocking Voltage $T_A = 100^\circ\text{C}$	I_R	5.0 100		μA
Maximum Full Load Reverse Current Full Cycle Average, .375", (9.5mm) Lead Length $T_A = 70^\circ\text{C}$	$I_{R(AV)}$	200		μA
Maximum Reverse Recovery Time (Note 1) $T_J = 25^\circ\text{C}$	T_{RR}	15.0	20.0	μs
Typical Junction Capacitance (Note 2)	C_J	4.0		pf
Typical Thermal Resistance (Note 3)	$R_{\theta JA}$	20.0		$^\circ\text{C}/\text{W}$
Operating Storage Temperature Range	T_J, T_{STG}	-65 to +175		$^\circ\text{C}$

NOTES:

1. Measured with $I_F = 0.5\text{A}$, $I_R = 50\text{mA}$.
2. Measured at 1 MHz and applied reverse voltage of $4.0 V_{DC}$.
3. Thermal Resistance from Junction to Ambient at .375" (9.5mm) Lead Lengths, P.C. Board Mounted.

RATINGS AND CHARACTERISTIC CURVES CG3 AND DG3

AVERAGE FORWARD RECTIFIED CURRENT, AMPERES

FIG. 1 — FORWARD CURRENT DERATING CURVE

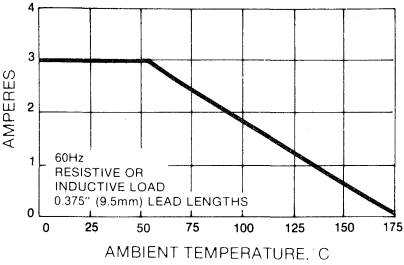

INSTANTANEOUS FORWARD CURRENT, AMPERES

FIG. 3 — TYPICAL INSTANTANEOUS FORWARD CHARACTERISTICS

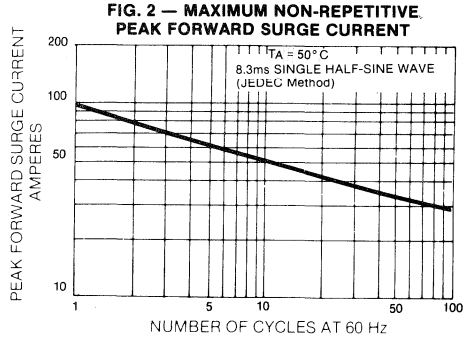
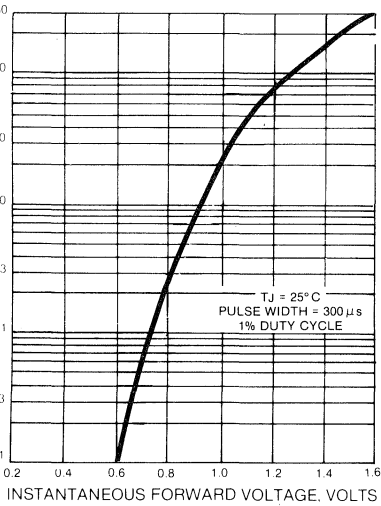
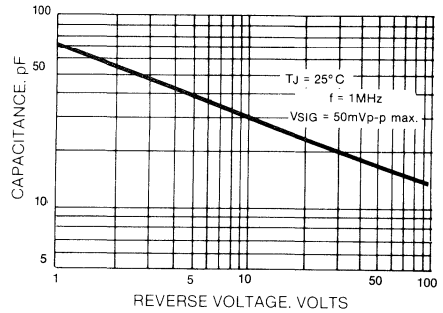

FIG. 4 — TYPICAL JUNCTION CAPACITANCE



INSTANTANEOUS REVERSE CURRENT, MICROAMPERES

FIG. 5 — TYPICAL REVERSE CHARACTERISTICS

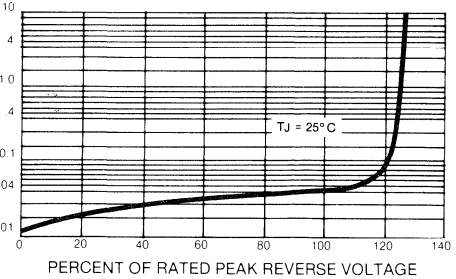
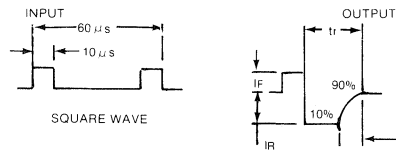
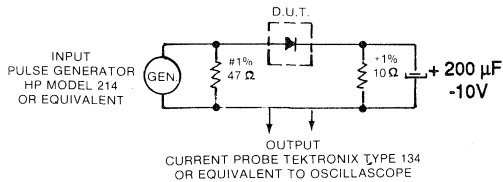

FIG. 6 — REVERSE RECOVERY TIME CHARACTERISTIC AND TEST DIAGRAM



**FAST RECOVERY GLASS
PASSIVATED RECTIFIERS**

***1.0 AMPERE TO 3.0 AMPERES
50 VOLTS TO 1000 VOLTS***

**GENERAL
INSTRUMENT**

1N4942 THRU 1N4948

MINIATURE GLASS PASSIVATED JUNCTION FAST SWITCHING RECTIFIER

Voltage - 200 to 1000 Volts **Current** - 1.0 Ampere

FEATURES

- ◆ High temperature metallurgically bonded constructed rectifiers
- ◆ Glass passivated cavity-free junction in DO-204AP package
- ◆ 1.0 Ampere operation at $T_A = 55^\circ\text{C}$ with no thermal runaway
- ◆ Typical I_R less than $0.1 \mu\text{A}$
- ◆ Capable of meeting environmental standards of MIL-S-19500
- ◆ Fast switching for high efficiency
- ◆ High temperature soldering guaranteed: $350^\circ\text{C}/10$ seconds/.375", (9.5mm) lead length at 5 lbs., (2.3kg) tension

MECHANICAL DATA

Case: One piece glass, hermetically sealed

Terminals: Axial leads, solderable per MIL-STD-202, Method 208

Polarity: Color band denotes cathode

Mounting Position: Any

Weight: .02 ounce, .56 grams

PATENTED*

DO-204AP

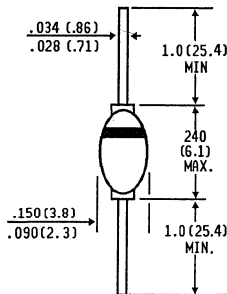

Dimensions in inches
and
(millimeters)

*Braze-lead assembly is covered by Patent No. 3,930,306 of 1976 and glass composition by Patent No. 3,752,701 of 1973

MAXIMUM RATINGS AND ELECTRICAL CHARACTERISTICS

Ratings at 25°C ambient temperature unless otherwise specified.
Resistive or inductive load. For capacitive load, derate current by 20%.

	SYMBOLS	1N4942	1N4944	1N4946	1N4947	1N4948	UNITS
*Maximum Recurrent Peak Reverse Voltage	V_{RRM}	200	400	600	800	1000	Volts
Maximum RMS Voltage	V_{RMS}	140	280	420	560	700	Volts
*Maximum DC Blocking Voltage	V_{DC}	200	400	600	800	1000	Volts
*Minimum Avalanche Breakdown Voltage at $50 \mu\text{A}$	V_{BR}	220	440	660	880	1100	Volts
*Maximum Average Forward Rectified Current .375", (9.5mm) Lead Lengths at $T_A = 55^\circ\text{C}$	$I_{(AV)}$	1.0					Amps
*Peak Forward Surge Current 8.3ms single half sine-wave superimposed on rated load (JEDEC Method)	I_{FSM}	25.0					Amps
*Maximum Instantaneous Forward Voltage at 1.0A at 2.0A, $T_A = 40^\circ\text{C}$	V_F	1.3					Volts
	V_F	2.5					Volts
*Maximum DC Reverse Current $T_A = 25^\circ\text{C}$ at Rated DC Blocking Voltage $T_A = 175^\circ\text{C}$	I_R	1.0					μA
	I_R	500					μA
*Maximum Reverse Recovery Time (Note 1) $T_J = 25^\circ\text{C}$	T_{RR}	150	150	250	250	500	ns
Typical Junction Capacitance (Note 2)	C_J	15.0					pf
Typical Thermal Resistance (Note 4)	$R_{\theta JA}$	50.0					$^\circ\text{C}/\text{W}$
*Operating and Storage Temperature Range	T_J, T_{STG}	-65 to +175					$^\circ\text{C}$

NOTES:

1. Reverse Recovery Test Conditions : $I_F = 0.5\text{A}$, $I_R = 1.0\text{A}$, $I_{rr} = 25\text{A}$.
 2. Measured at 1 MHz and applied reverse voltage of 4.0 volts.
 3. Available to JAN and JAN TX Military Specifications MIL-ST-19500/359
 4. Thermal Resistance from Junction to Ambient at .375" (9.5mm) Lead Lengths, P.C. Board Mounted.
- *JEDEC Registered Values

RATINGS AND CHARACTERISTIC CURVES 1N4942 THRU 1N4948

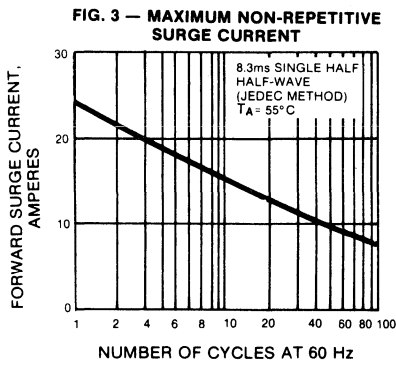
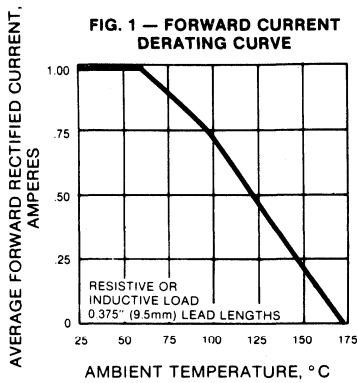

FIG. 5 — TYPICAL JUNCTION CAPACITANCE

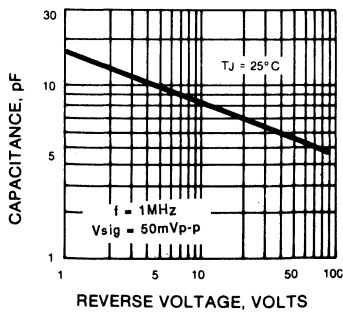

FIG. 2 — TYPICAL INSTANTANEOUS FORWARD CHARACTERISTICS

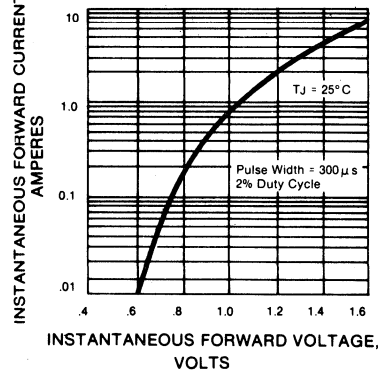

FIG. 4 — TYPICAL REVERSE CHARACTERISTICS

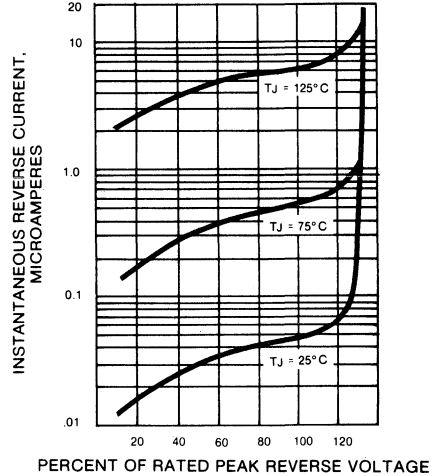
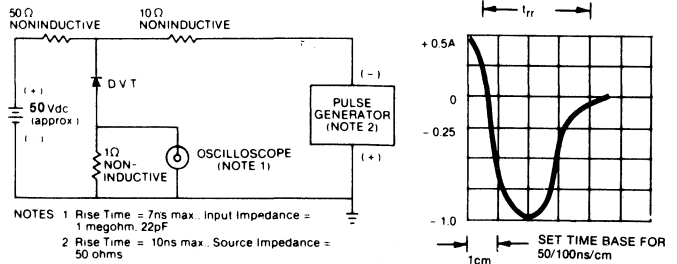

FIG. 6 — REVERSE RECOVERY TIME CHARACTERISTIC AND TEST CIRCUIT DIAGRAM



1N5615 THRU 1N5623

MINIATURE GLASS PASSIVATED JUNCTION FAST SWITCHING RECTIFIER

Voltage - 200 to 1000 Volts Current - 1.0 Ampere

FEATURES

- ◆ High temperature metallurgically bonded constructed rectifiers
- ◆ Glass passivated cavity-free junction in a DO-204AP package
- ◆ 1.0 Ampere operation at $T_A = 55^\circ\text{C}$ with no thermal runaway
- ◆ Typical I_R less than $0.1 \mu\text{A}$
- ◆ Capable of meeting environmental standards of MIL-S-19500
- ◆ Fast switching for high efficiency
- ◆ High temperature soldering guaranteed: $350^\circ\text{C}/10$ seconds/.375", (9.5mm) lead length at 5 lbs., (2.3kg) tension

PATENTED*

DO-204AP

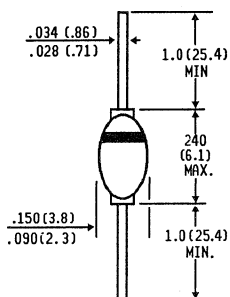

Dimensions in inches
and
(millimeters)

* Brazed-lead assembly is covered by Patent No. 3,930,306 of 1976 and glass composition by Patent No. 3,752,701 of 1973

MECHANICAL DATA

Case: One piece glass, hermetically sealed

Terminals: Axial leads, solderable per MIL-STD-202, Method 208

Polarity: Color band denotes cathode

Mounting Position: Any

Weight: .02 ounce, .56 grams

MAXIMUM RATINGS AND ELECTRICAL CHARACTERISTICS

Ratings at 25°C ambient temperature unless otherwise specified.
Resistive or inductive load. For capacitive load, derate current by 20%.

	SYMBOLS	1N5615	1N5617	1N5619	1N5621	1N5623	UNITS
*Maximum Recurrent Peak Reverse Voltage	V_{RRM}	200	400	600	800	1000	Volts
Maximum RMS Voltage	V_{RMS}	140	280	420	560	700	Volts
*Maximum DC Blocking Voltage	V_{DC}	200	400	600	800	1000	Volts
*Minimum Avalanche Breakdown Voltage at $50 \mu\text{A}$	V_{BR}	220	440	660	880	1100	Volts
*Maximum Average Forward Rectified Current .375", (9.5mm) Lead Lengths at $T_A = 55^\circ\text{C}$	$I_{(AV)}$	1.0					Amps
*Peak Forward Surge Current 8.3ms single half sine-wave superimposed on rated load (JEDEC Method)	I_{FSM}	50.0					Amps
*Maximum Instantaneous Forward Voltage at 1.0A	V_F	1.2					Volts
*Maximum DC Reverse Current $T_A = 25^\circ\text{C}$ at Rated DC Blocking Voltage $T_A = 100^\circ\text{C}$ $T_A = 200^\circ\text{C}$	I_R	0.5 25.0 1500					μA
*Maximum Reverse Recovery Time (Note 1) $T_J = 25^\circ\text{C}$	T_{RR}	150	150	250	300	500	ns
*Maximum Junction Capacitance (Note 2)	C_J	45	35	25	20	15	pf
Typical Thermal Resistance (Note 4)	$R_{\theta JA}$	50.0					$^\circ\text{C}/\text{W}$
*Operating Temperature Range	T_J	-65 to +175					$^\circ\text{C}$
*Storage Temperature Range	T_{STG}	-65 to +200					$^\circ\text{C}$

NOTES:

1. Reverse Recovery Test Conditions : $I_F = 0.5\text{A}$, $I_R = 1.0\text{A}$, $I_{rr} = 25\text{A}$.
 2. Measured at 1 MHz and applied reverse voltage of 12 volts.
 3. Available to JAN and JAN TX Military Specifications MIL-S-19500/429.
 4. Thermal Resistance from Junction to Ambient at .375" (9.5mm) Lead Lengths, P.C. Board Mounted.
- *JEDEC Registered Values

RATINGS AND CHARACTERISTIC CURVES 1N5615 THRU 1N5623

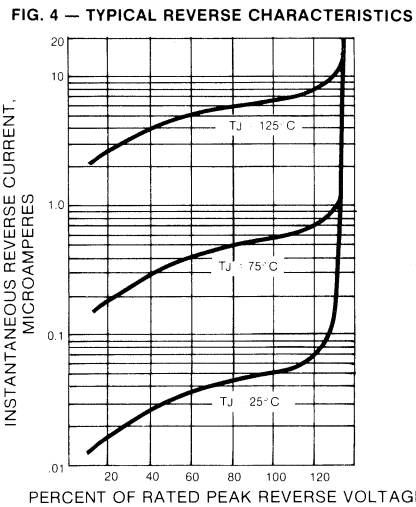
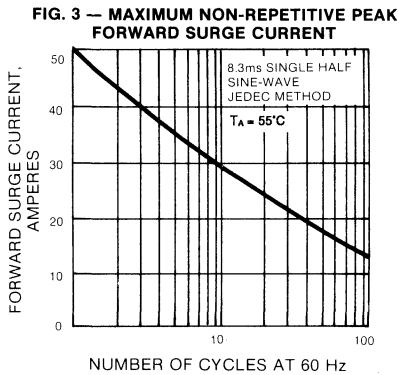
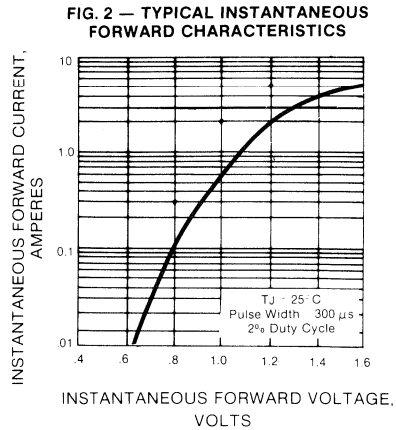
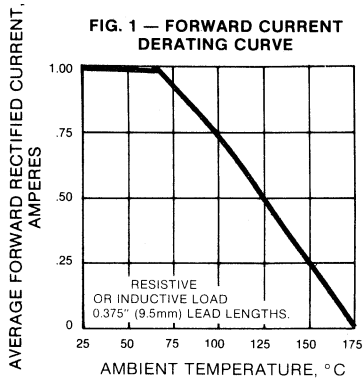

FIG. 5 — TYPICAL JUNCTION CAPACITANCE

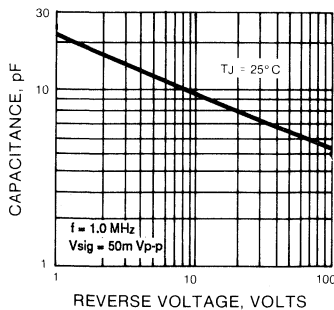
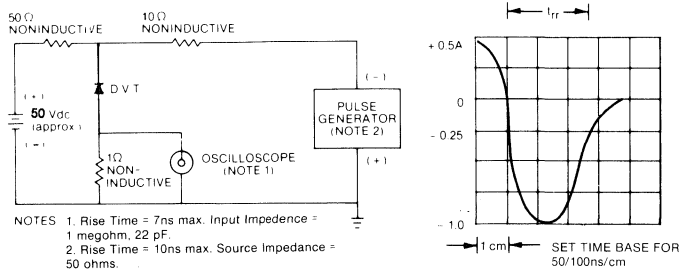

FIG. 6 — REVERSE RECOVERY TIME CHARACTERISTIC AND TEST CIRCUIT DIAGRAM



RG1A THRU RG1M

MINIATURE GLASS PASSIVATED JUNCTION FAST SWITCHING RECTIFIER

Voltage - 50 to 1000 Volts Current- 1.0 Ampere

FEATURES

- ◆ High temperature metallurgically bonded constructed rectifiers
- ◆ Glass passivated cavity-free junction in a DO-204AP package
- ◆ 1.0 Ampere operation at $T_A = 55^\circ\text{C}$ with no thermal runaway
- ◆ Typical I_R less than $0.1 \mu\text{A}$
- ◆ Capable of meeting environmental standards of MIL-S-19500
- ◆ Fast switching for high efficiency
- ◆ High temperature soldering guaranteed: $350^\circ\text{C}/10$ seconds/.375", (9.5mm) lead length at 5 lbs., (2.3kg) tension

PATENTED*

DO-204AP

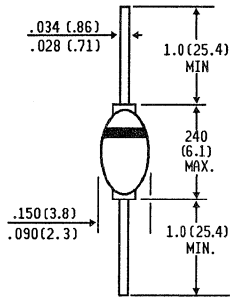

Dimensions in inches
and
(millimeters)

*Brazed-lead assembly is covered by Patent No. 3,930,306 of 1976 and glass composition by Patent No.3,752,701 of 1973

MECHANICAL DATA

Case: One piece glass, hermetically sealed

Terminals: Axial leads, solderable per MIL-STD-202, Method 208

Polarity: Color band denotes cathode

Mounting Position: Any

Weight: .02 ounce, .56 grams

MAXIMUM RATINGS AND ELECTRICAL CHARACTERISTICS

Ratings at 25°C ambient temperature unless otherwise specified.
Resistive or inductive load. For capacitive load, derate current by 20%.

	SYMBOLS	RG1A	RG1B	RG1D	RG1G	RG1J	RG1K	RG1M	UNITS
Maximum Recurrent Peak Reverse Voltage	V_{RRM}	50	100	200	400	600	800	1000	Volts
Maximum RMS Voltage	V_{RMS}	35	70	140	280	420	560	700	Volts
Maximum DC Blocking Voltage	V_{DC}	50	100	200	400	600	800	1000	Volts
Maximum Average Forward Rectified Current, .375" (9.5mm) Lead Length at $T_A = 55^\circ\text{C}$	$I_{(AV)}$	1.0							Amps
Peak Forward Surge Current 8.3ms single half sine-wave superimposed on rated load (JEDEC Method)	I_{FSM}	30							Amps
Maximum Instantaneous Forward Voltage at 1.0A	V_F	1.3							Volts
Maximum Full Load Reverse Current, Full Cycle Average, .375", (9.5mm) Lead Length at $T_A = 25^\circ\text{C}$ $T_A = 100^\circ\text{C}$	$I_{R(AV)}$	1.0 100							μA
Maximum DC Reverse Current at Rated DC Blocking Voltage	I_R	2.0							μA
Maximum Reverse Recovery Time (Note 1) $T_J = 25^\circ\text{C}$	T_{RR}	150			200	250	500		ns
Typical Junction Capacitance (Note 2)	C_J	15.0							pf
Typical Thermal Resistance (Note 3)	$R_{\theta JA}$	50.0							$^\circ\text{C}/\text{W}$
Operating and Storage Temperature Range	T_J, T_{STG}	-65 to +175							$^\circ\text{C}$

NOTES:

- Reverse Recovery Test Conditions: $I_F = 0.5\text{A}$, $I_R = 1.0\text{A}$, $I_{rr} = .25\text{A}$.
- Measured at 1.0 MHz and applied reverse voltage of $4.0 V_{DC}$.
- Thermal Resistance from Junction to Ambient at .375" (9.5mm) Lead Lengths, P.C. Board Mounted.

RATINGS AND CHARACTERISTIC CURVES RG1A THRU RG1M

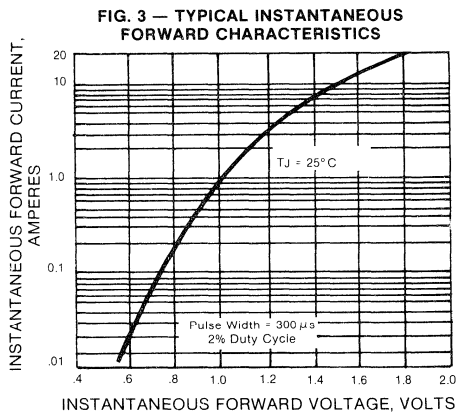
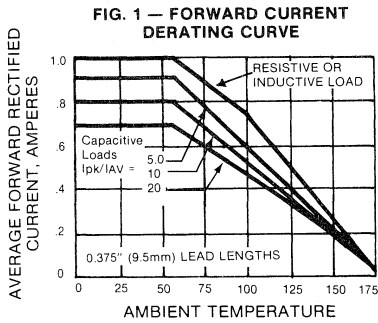

FIG. 5 — TYPICAL JUNCTION CAPACITANCE

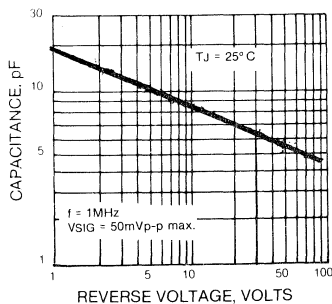

FIG. 2 — MAXIMUM NON-REPETITIVE PEAK FORWARD SURGE CURRENT

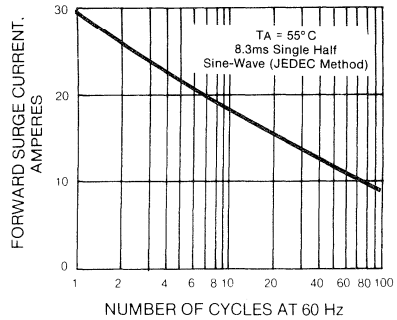

FIG. 4 — TYPICAL REVERSE CHARACTERISTICS

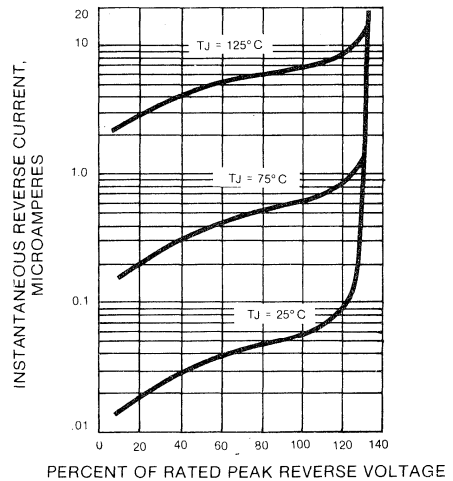
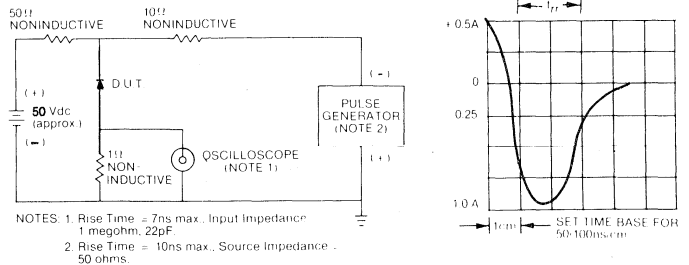

FIG. 6 — REVERSE RECOVERY TIME CHARACTERISTIC AND TEST CIRCUIT DIAGRAM



BYV95 AND BYV96 SERIES

MINIATURE GLASS PASSIVATED JUNCTION FAST SWITCHING RECTIFIER

Voltage - 200 to 1000 Volts Current- 1.5 Amperes

FEATURES

- ◆ High temperature metallurgically bonded constructed rectifiers
- ◆ Glass passivated cavity-free junction in a DO-204AP package
- ◆ 1.5 Ampere operation at $T_A = 55^\circ\text{C}$ with no thermal runaway
- ◆ Typical I_R less than $0.1 \mu\text{A}$
- ◆ Capable of meeting environmental standards of MIL-S-19500
- ◆ Fast switching for high efficiency up to 100 KHz
- ◆ High temperature soldering guaranteed: $350^\circ\text{C}/10$ seconds/.375", (9.5mm) lead length at 5 lbs., (2.3kg) tension

PATENTED*

DO-204AP

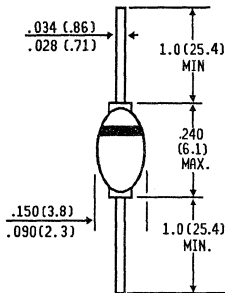

Dimensions in inches and (millimeters)

* Brazed-lead assembly is covered by Patent No. 3,930,306 of 1976 and glass composition by Patent No. 3,752,701 of 1973

MECHANICAL DATA

Case: One piece glass, hermetically sealed

Terminals: Axial leads, solderable per MIL-STD-202, Method 208

Polarity: Color band denotes cathode

Mounting Position: Any

Weight: .02 ounce, .56 grams

MAXIMUM RATINGS AND ELECTRICAL CHARACTERISTICS

Ratings at 25°C ambient temperature unless otherwise specified.
Resistive or inductive load. For capacitive load, derate current by 20%.

	SYMBOLS	BYV95A	BYV95B	BYV95C	BYV96D	BYV96E	UNITS
Maximum Recurrent Peak Reverse Voltage	V_{RRM}	200	400	600	800	1000	Volts
Maximum RMS Voltage	V_{RMS}	140	280	420	560	700	Volts
Maximum DC Blocking Voltage	V_{DC}	200	400	600	800	1000	Volts
Minimum Avalanche Breakdown Voltage at $100 \mu\text{A}$	V_{BR}	300	500	800	900	1100	Volts
Maximum Average Forward Rectified Current .375", (9.5mm) Lead Lengths at $T_A = 55^\circ\text{C}$	$I_{(AV)}$	1.5					Amps
Peak Forward Surge Current *10ms single half sine-wave superimposed on rated load	I_{FSM}	35.0					Amps
Maximum Instantaneous Forward Voltage at 3.0A $T_A = 25^\circ\text{C}$ $T_J = 165^\circ\text{C}$	V_F	1.6 1.35					Volts
Maximum Full Load Reverse Current, Full Cycle Average, .375", (9.5mm) Lead Length at $T_J = 25^\circ\text{C}$ $T_J = 165^\circ\text{C}$	$I_{R(AV)}$	1.0 150					μA
Maximum DC Reverse Current, at rated DC Blocking Voltage	I_R	2.0					μA
Maximum Reverse Recovery Time (Note 1) $T_J = 25^\circ\text{C}$	T_{RR}	250			300		ns
Typical Junction Capacitance (Note 2)	C_J	10.0					pf
Typical Thermal Resistance (Note 3)	$R_{\theta JA}$	50.0					$^\circ\text{C}/\text{W}$
Operating Temperature Range	T_J	-65 to +175					$^\circ\text{C}$
Storage Temperature Range	T_{STG}	-65 to +200					$^\circ\text{C}$

- NOTES: 1. Measured with $I_F = 0.5\text{A}$, $I_R = 1.0\text{A}$, $I_{rr} = .25\text{A}$.
2. Measured at 1 MHz and applied reverse voltage of 4.0 Vdc.
3. Thermal Resistance from Junction to Ambient at .375" (9.5mm) Lead Lengths, P.C. Board Mounted.

RATING AND CHARACTERISTIC CURVES BYV95 AND BYV96 SERIES

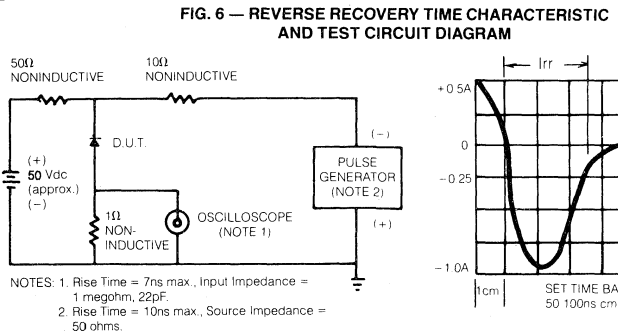
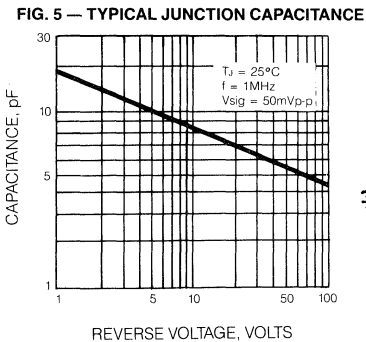
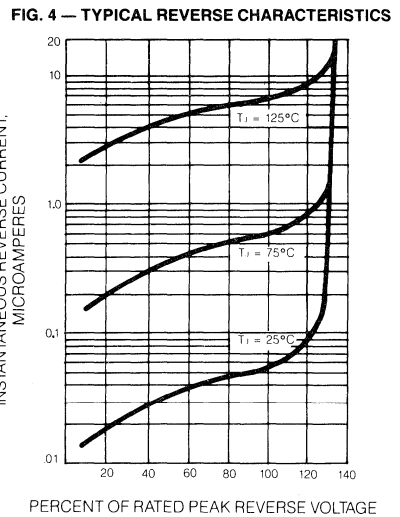
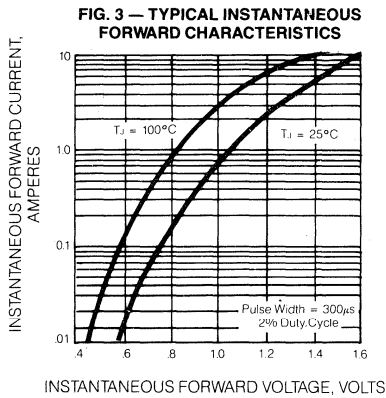
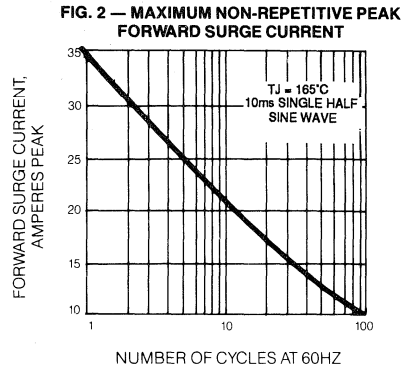
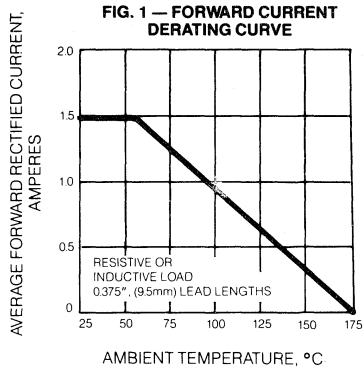

RG2A THRU RG2M

MINIATURE GLASS PASSIVATED JUNCTION FAST SWITCHING RECTIFIER

Voltage - 50 to 1000 Volts Current - 2.0 Amperes

FEATURES

PATENTED*

DO-204AP

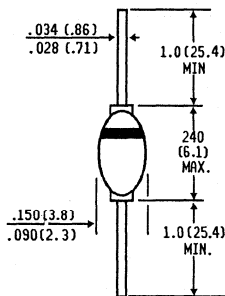

Dimensions in inches
and
(millimeters)

- ◆ High temperature metallurgically bonded constructed rectifiers
- ◆ Glass passivated cavity-free junction in a DO-204AP package
- ◆ 1.0 Ampere operation at $T_A = 55^\circ\text{C}$ with no thermal runaway
- ◆ Typical I_R less than 0.1 μA
- ◆ Capable of meeting environmental standards of MIL-S-19500
- ◆ Fast switching for high efficiency
- ◆ High temperature soldering guaranteed: $350^\circ\text{C}/10$ seconds/.375", (9.5mm) lead length at 5 lbs., (2.3kg) tension

MECHANICAL DATA

Case: One piece glass, hermetically sealed

Terminals: Axial leads, solderable per MIL-STD-202, Method 208

Polarity: Color band denotes cathode

Mounting Position: Any

Weight: .02 ounce, .56 grams

* Brazed-lead assembly is covered by Patent No. 3,930,306 of 1976 and glass composition by Patent No. 3,752,701 of 1973

MAXIMUM RATINGS AND ELECTRICAL CHARACTERISTICS

Ratings at 25°C ambient temperature unless otherwise specified.
Single phase, half wave, 60Hz, resistive or inductive load.

	SYMBOLS	RG2A	RG2B	RG2D	RG2G	RG2J	RG2K	RG2M	UNITS
Maximum Recurrent Peak Reverse Voltage	V_{RRM}	50	100	200	400	600	800	1000	Volts
Maximum RMS Voltage	V_{RMS}	35	70	140	280	420	560	700	Volts
Maximum DC Blocking Voltage	V_{DC}	50	100	200	400	600	800	1000	Volts
Maximum Average Forward Rectified Current .375", (9.5mm) Lead Lengths at $T_A = 55^\circ\text{C}$	$I_{(AV)}$	2.0							Amps
Peak Forward Surge Current 8.3ms single half sine-wave superimposed on rated load (JEDEC Method)	I_{FSM}	50.0							Amps
Maximum Instantaneous Forward Voltage at 2.0A	V_F	1.3							Volts
Maximum Full Load Reverse Current Full Cycle Average, .375", (9.5mm) $T_A = 25^\circ\text{C}$ $T_A = 100^\circ\text{C}$	$I_{R(AV)}$	1.0 100							μA
Maximum DC Reverse Current, at Rated DC Blocking Voltage	I_R	5.0							μA
Maximum Reverse Recovery Time (Note 1) $T_J = 25^\circ\text{C}$	T_{RR}	150			200	250	500		ns
Typical Junction Capacitance (Note 2)	C_J	15.0							pf
Typical Thermal Resistance (Note 3)	$R_{\theta JA}$	50.0							$^\circ\text{C}/\text{W}$
Operating and Storage Temperature Range	T_J, T_{STG}	-65 to +175							$^\circ\text{C}$

NOTES:

1. Measured with $I_F = 0.5\text{A}$, $I_R = 1.0\text{A}$, $I_{rr} = 25\text{A}$.
2. Measured at 1 MHz and applied reverse voltage of 4.0 V_{DC} .
3. Thermal Resistance from Junction to Ambient at .375" (9.5mm) Lead Lengths, P.C. Board Mounted.

RATINGS AND CHARACTERISTIC CURVES RG2A THRU RG2M

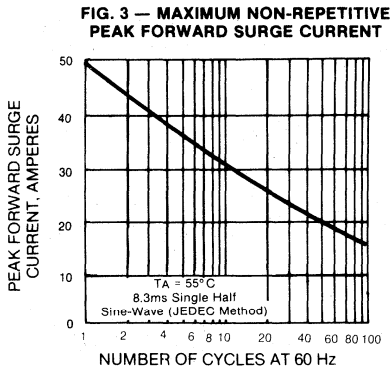
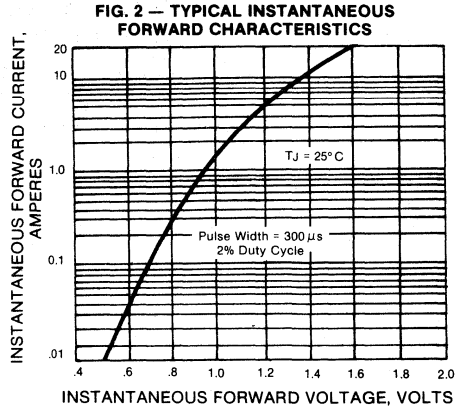
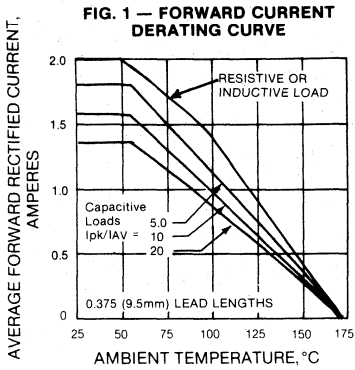

FIG. 4 — TYPICAL REVERSE CHARACTERISTIC

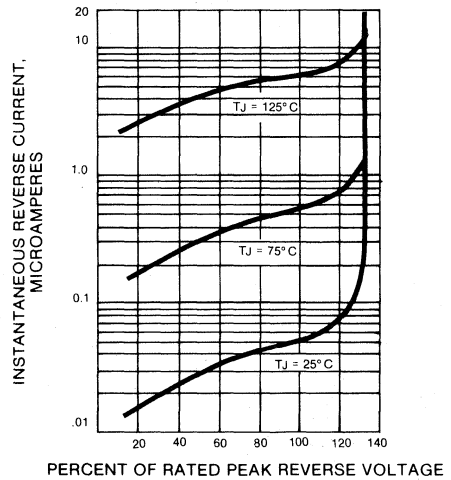

FIG. 5 — TYPICAL JUNCTION CAPACITANCE

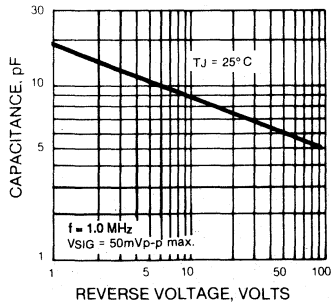
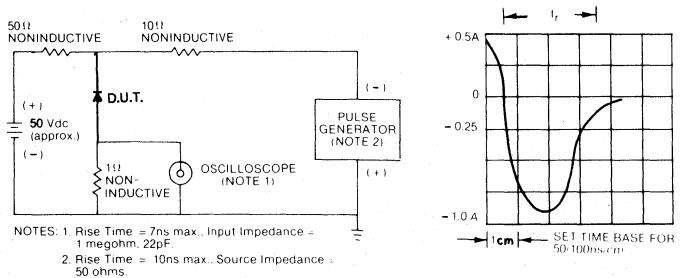

FIG. 5 — REVERSE RECOVERY TIME CHARACTERISTIC AND TEST CIRCUIT DIAGRAM



BYW32 THRU BYW36

MINIATURE GLASS PASSIVATED JUNCTION FAST SWITCHING RECTIFIER

Voltage - 200 to 600 Volts Current- 2.0 Amperes

FEATURES

PATENTED*

DO-204AP

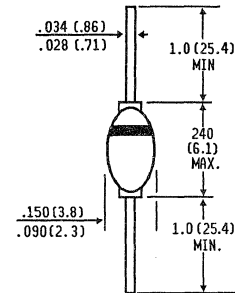

Dimensions in inches and (millimeters)

* Brazed-lead assembly is covered by Patent No. 3,930,306 of 1976 and glass composition by Patent No. 3,752,701 of 1973

- ◆ High temperature metallurgically bonded constructed rectifiers
- ◆ Glass passivated cavity-free junction in a DO-204AP package
- ◆ 2.0 Ampere operation at $T_A = 55^\circ\text{C}$ with no thermal runaway
- ◆ Typical I_R less than $0.1 \mu\text{A}$
- ◆ Capable of meeting environmental standards of MIL-S-19500
- ◆ Fast switching for high efficiency
- ◆ High temperature soldering guaranteed: $350^\circ\text{C}/10$ seconds/.375", (9.5mm) lead length at 5 lbs., (2.3kg) tension

MECHANICAL DATA

Case: One piece glass, hermetically sealed

Terminals: Axial leads, solderable per MIL-STD-202, Method 208

Polarity: Color band denotes cathode

Mounting Position: Any

Weight: .02 ounce, .56 gram

MAXIMUM RATINGS AND ELECTRICAL CHARACTERISTICS

Ratings at 25°C ambient temperature unless otherwise specified.
Resistive or inductive load. For capacitive load, derate current by 20%.

	SYMBOLS	BYW32	BYW33	BYW34	BYW35	BYW36	UNITS
Maximum Recurrent Peak Reverse Voltage	V_{RRM}	200	300	400	500	600	Volts
Maximum RMS Voltage	V_{RMS}	140	210	280	350	420	Volts
Maximum DC Blocking Voltage	V_{DC}	200	300	400	500	600	Volts
Maximum Average Forward Rectified Current .375", (9.5mm) Lead Lengths at $T_A = 55^\circ\text{C}$	$I_{(AV)}$	2.0					Amps
Peak Forward Surge Current 10ms single half sine-wave superimposed on rated load at $T_A = 25^\circ\text{C}$	I_{FSM}	40.0					Amps
Maximum Instantaneous Forward Voltage at 1.0A	V_F	1.2					Volts
Maximum DC Reverse Current at Rated DC Blocking Voltage	I_R	5.0					μA
Maximum Full Load Reverse Current Full Cycle Average, .375", (9.5mm) Lead Length $T_A = 25^\circ\text{C}$ $T_A = 100^\circ\text{C}$	$I_{R(AV)}$	5.0 50.0					μA
Maximum Reverse Recovery Time (Note 1) $T_J = 25^\circ\text{C}$	T_{RR}	200					ns
Typical Junction Capacitance (Note 2)	C_J	15.0					pf
Typical Thermal Resistance (Note 3)	$R_{\theta JA}$	50.0					$^\circ\text{C/W}$
Operating Temperature Range	T_J	-65 to +175					$^\circ\text{C}$
Storage Temperature Range	T_{STG}	-65 to 200					$^\circ\text{C}$

NOTES:

1. Measured with $I_F = 0.5\text{A}$, $I_R = 1.0\text{A}$, $I_{rr} = 25\text{A}$.
2. Measured at 1 MHz and applied reverse voltage of $4.0 V_{DC}$.
3. Thermal Resistance from Junction to Ambient at .375" (9.5mm) Lead Lengths, P.C. Board Mounted.

RATING AND CHARACTERISTIC CURVES BYW32 THRU BYW36

FIG. 1 — TYPICAL INSTANTANEOUS FORWARD CHARACTERISTICS

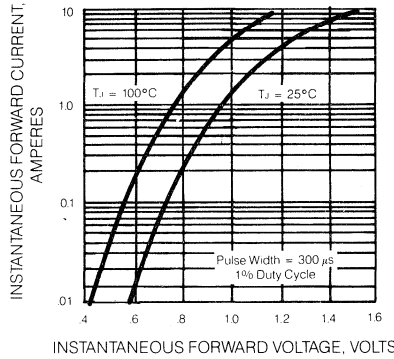

FIG. 2 — FORWARD CURRENT DERATING CURVE

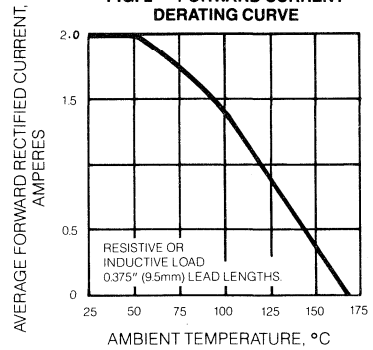

FIG. 3 — TYPICAL JUNCTION CAPACITANCE

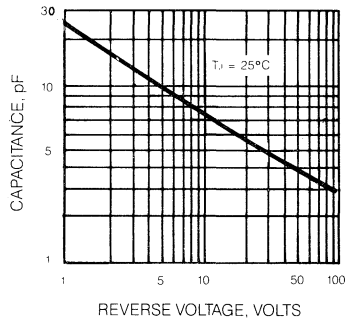

FIG. 4 — MAXIMUM NON-REPETITIVE PEAK FORWARD SURGE CURRENT

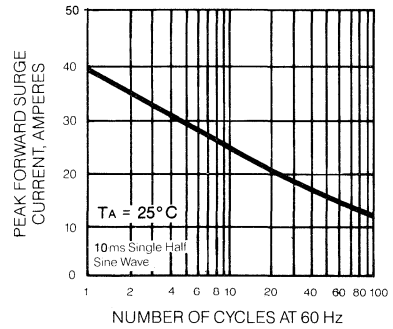

FIG. 5 — TYPICAL RECTIFICATION EFFICIENCY

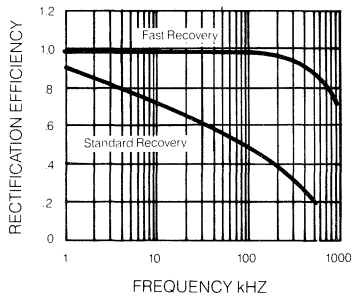
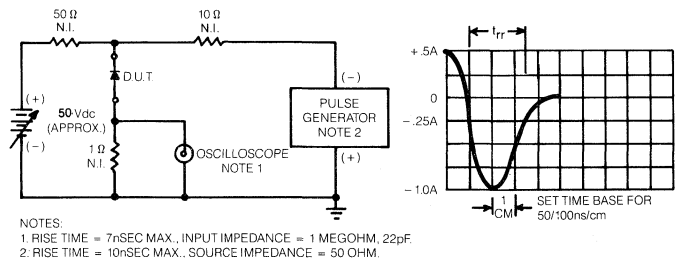

FIG. 6 — REVERSE RECOVERY TIME CHARACTERISTIC AND TEST DIAGRAM



1N5415 THRU 1N5420

FAST SWITCHING GLASS PASSIVATED SILICON RECTIFIER

Voltage - 50 to 600 Volts Current - 3.0 Amperes

FEATURES

- ◆ Glass passivated cavity-free junction
- ◆ High temperature metallurgically bonded
- ◆ Hermetically sealed package
- ◆ Capable of meeting environmental standards of MIL-S-19500
- ◆ Fast switching for high efficiency
- ◆ High temperature soldering guaranteed: 350°C/10 seconds/.375" (9.5mm) lead length at 5 lbs., (2.3kg) tension

PATENTED*

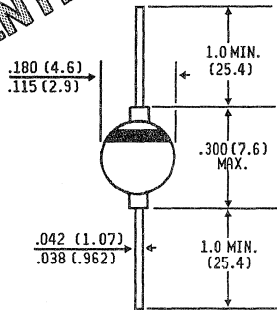

Dimensions in inches and (millimeters)

* Brazed-lead assembly is covered by Patent No. 3,930,306 of 1976 and glass composition by Patent No. 3,752,701 of 1973

MECHANICAL DATA

Case: One piece glass, hermetically sealed
Terminals: Plated Axial leads, solderable per MIL-STD-202, Method 208
Polarity: Color band denotes cathode
Mounting Position: Any
Weight: .037 ounce, 1.04 grams

MAXIMUM RATINGS AND ELECTRICAL CHARACTERISTICS

Ratings at 25°C ambient temperature unless otherwise specified.
 Resistive or inductive load. For capacitive load, derate current by 20%.

	SYMBOLS	1N5415	1N5416	1N5417	1N5418	1N5419	1N5420	UNITS
*Maximum Recurrent Peak Reverse Voltage	V_{RRM}	50	100	200	400	500	600	Volts
Maximum RMS Voltage	V_{RMS}	35	70	140	280	350	420	Volts
*Maximum DC Blocking Voltage	V_{DC}	50	100	200	400	500	600	Volts
*Minimum Reverse Breakdown Voltage at 50 μ A	V_{BR}	55	110	220	440	550	660	Volts
*Maximum Average Forward Rectified Current .375", (9.5mm) Lead Lengths at $T_A = 55^\circ\text{C}$	$I_{(AV)}$	3.0						Amps
Peak Forward Surge Current 8.3ms single half sine-wave superimposed on rated load (JEDEC Method) at $T_A = 100^\circ\text{C}$	I_{FSM}	80.0						Amps
Maximum Instantaneous Forward Voltage at 3.0A* at 9.0A	V_F	1.10 1.50						Volts
Maximum DC Reverse Current at Rated DC Blocking Voltage $*T_A = 25^\circ\text{C}$ $T_A = 100^\circ\text{C}$ $*T_A = 175^\circ\text{C}$	I_R	1.0 20.0 2.0						μA μA mA
*Maximum Junction Capacitance (Note 2)	C_J	200	175	150	120	110	100	pf
*Maximum Reverse Recovery Time (Note 1) $T_J = 25^\circ\text{C}$	T_{RR}	150 250						400 ns
Typical Thermal Resistance (Note 4)	$R_{\theta JA}$	17.0						$^\circ\text{C/W}$
*Operating and Storage Temperature Range	T_J, T_{STG}	-65 to 175						$^\circ\text{C}$

NOTES:

1. Reverse Recovery Test Conditions : $I_F = 0.5\text{A}$, $I_R = 1.0\text{A}$, $I_{rr} = 25\text{A}$.
 2. Measured at 1 MHz and applied reverse voltage of 12.0 volts.
 3. Available to JAN and JAN TX Military Specifications MIL-S-19500/411D.
 4. Thermal Resistance from Junction to Ambient at .375" (9.5mm) Lead Lengths, with both leads to heat sink.
- * JEDEC Registered Values

RATINGS AND CHARACTERISTIC CURVES 1N5415 THRU 1N5420

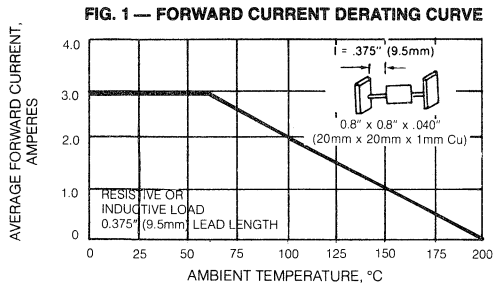

FIG. 3 — TYPICAL INSTANTANEOUS FORWARD CHARACTERISTICS

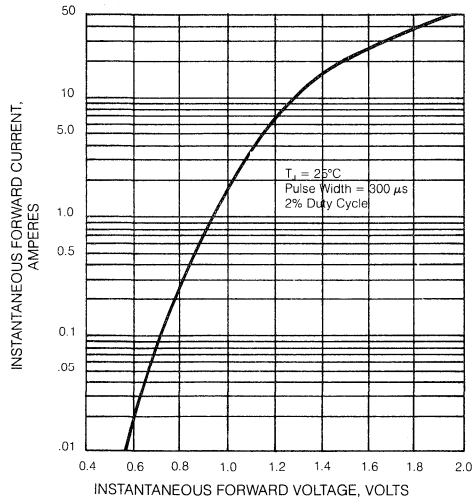

FIG. 6 — REVERSE RECOVERY TIME CHARACTERISTIC AND TEST CIRCUIT DIAGRAM

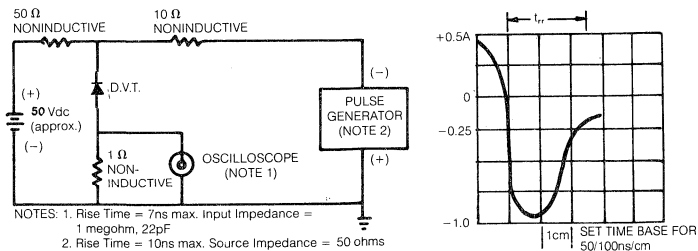

FIG. 2 — MAXIMUM NON-REPETITIVE PEAK FORWARD SURGE CURRENT

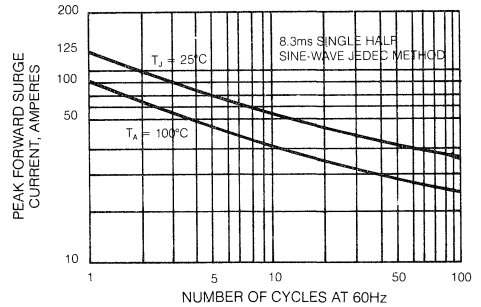

FIG. 4 — TYPICAL JUNCTION CAPACITANCE

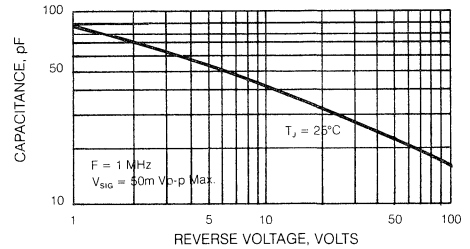
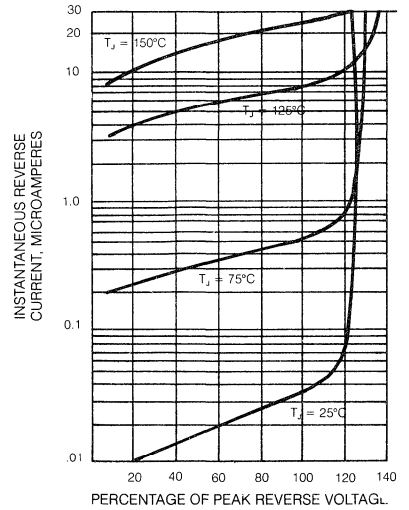

FIG. 5 — TYPICAL REVERSE CHARACTERISTICS



RG3A THRU RG3M

FAST SWITCHING GLASS PASSIVATED SILICON RECTIFIER

Voltage - 50 to 1000 Volts Current - 3.0 Amperes

FEATURES

PATENTED*

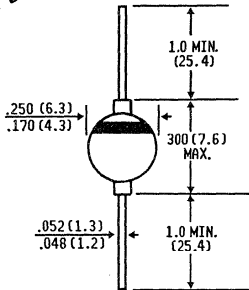

Dimension in inches
and
(millimeters)

* Brazed-lead assembly is covered by Patent No. 3,930,306 of 1976 and glass composition by Patent No. 3,752,701 of 1973

- ◆ High temperature metallurgically bonded constructed rectifiers
- ◆ Glass passivated cavity-free junction
- ◆ Hermetically sealed package
- ◆ 3.0 Ampere operation at $T_A = 55^\circ\text{C}$ with no thermal runaway
- ◆ Typical I_R less than $0.1 \mu\text{A}$
- ◆ Capable of meeting environmental standards of MIL-S-19500
- ◆ Fast switching for high efficiency
- ◆ High temperature soldering guaranteed $350^\circ\text{C}/10$ seconds/.375", (9.5mm) lead length at 5 lbs., (2.3kg) tension

MECHANICAL DATA

Case: One piece glass, hermetically sealed
Terminals: Plated Axial leads, solderable per MIL-STD-202, Method 208
Polarity: Color band denotes cathode
Mounting Position: Any
Weight: .04 ounce, 1.1 grams

MAXIMUM RATINGS AND ELECTRICAL CHARACTERISTICS

Ratings at 25°C ambient temperature unless otherwise specified.
Resistive or inductive load. For capacitive load, derate current by 20%.

	SYMBOLS	RG3A	RG3B	RG3D	RG3G	RG3J	RG3K	RG3M	UNITS
Maximum Recurrent Peak Reverse Voltage	V_{RRM}	50	100	220	400	600	800	1000	Volts
Maximum RMS Voltage	V_{RMS}	35	70	140	280	420	560	700	Volts
Maximum DC Blocking Voltage	V_{DC}	50	100	200	400	600	800	1000	Volts
Maximum Average Forward Rectified Current .375", (9.5mm) Lead Lengths at $T_A = 55^\circ\text{C}$	$I_{(AV)}$	3.0							Amps
Peak Forward Surge Current 8.3ms single half sine-wave superimposed on rated load (JEDEC Method)	I_{FSM}	100							Amps
Maximum Instantaneous Forward Voltage at 3.0A	V_F	1.3							Volts
Maximum Average Reverse Current at Rated Peak Reverse Voltage $T_A = 25^\circ\text{C}$	$I_{R(AV)}$	2.0							μA
$T_A = 100^\circ\text{C}$		100							
Maximum DC Reverse Current at Rated DC Blocking Voltage $T_A = 25^\circ\text{C}$	I_R	5.0							μA
Maximum Reverse Recovery Time (Note 1) $T_J = 25^\circ\text{C}$	T_{RR}	150			250	400	500		ns
Typical Junction Capacitance (Note 2)	C_J	40.0							pf
Typical Thermal Resistance (Note 3)	$R_{\theta JA}$	22.0							$^\circ\text{C}/\text{W}$
Operating and Storage Temperature Range	T_J, T_{STG}	-65 to +175							$^\circ\text{C}$

NOTES:

1. Reverse Recovery Test Conditions: $I_F = 0.5\text{A}$, $I_R = 1.0\text{A}$, $I_{rr} = .25\text{A}$.
2. Measured at 1 MHz and applied reverse voltage of 4.0 V_{oc}.
3. Thermal Resistance from Junction to Ambient at .375" (9.5mm) Lead Lengths, with both leads attached to heat sink.

RATINGS AND CHARACTERISTIC CURVES RG3A THRU RG3M

FIG. 1 — FORWARD RECTIFIED CURRENT DERATING CURVE

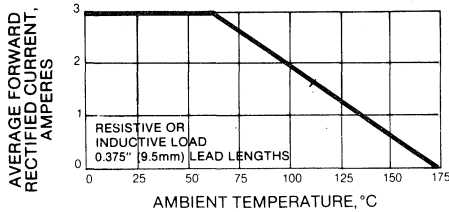

FIG. 3 — TYPICAL JUNCTION CAPACITANCE

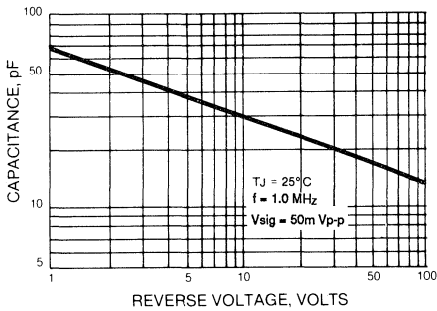

FIG. 5 — TYPICAL REVERSE CHARACTERISTICS

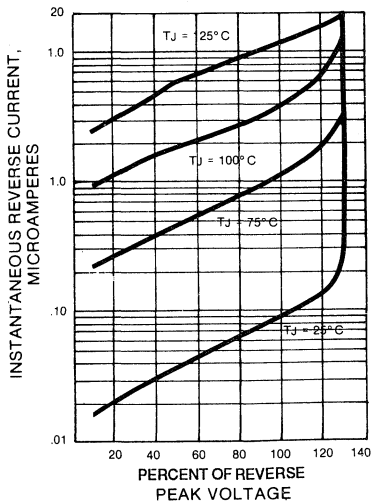

FIG. 2 — MAXIMUM NON-REPETITIVE PEAK FORWARD SURGE CURRENT

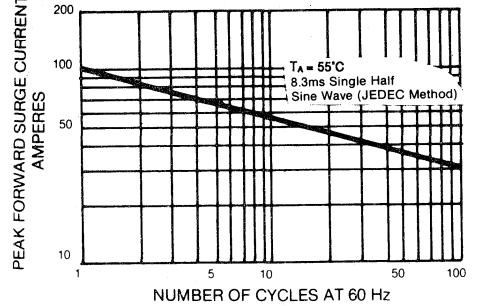

FIG. 4 — TYPICAL INSTANTANEOUS FORWARD CHARACTERISTICS

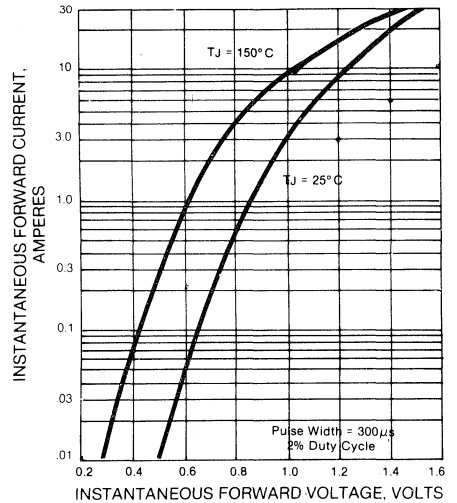
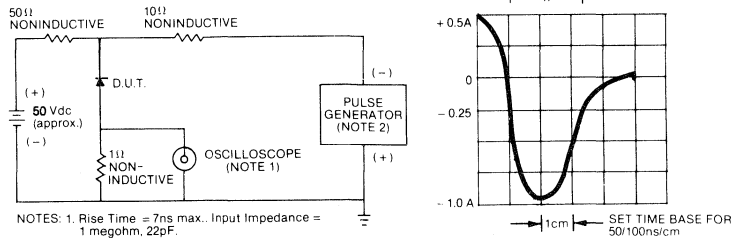

FIG. 6 — REVERSE RECOVERY TIME CHARACTERISTIC AND TEST CIRCUIT DIAGRAM



RG4A THRU RG4M

FAST SWITCHING GLASS PASSIVATED SILICON RECTIFIER
Voltage - 50 to 1000 Volts Current- 3.0 Amperes

FEATURES

PATENTED*

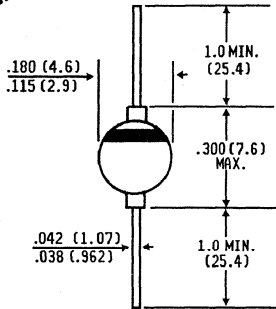

Dimensions in inches
and
(millimeters)

* Brazed-load assembly is covered by Patent No. 3,930,306 of 1976
and glass composition by Patent No.3,752,701 of 1973

- ◆ High temperature metallurgically bonded constructed rectifiers
- ◆ Glass passivated cavity-free junction
- ◆ Capable of meeting environmental standards of MIL-S-19500
- ◆ Fast switching for fast efficiency
- ◆ 3.0 Ampere operation at $T_A = 50^\circ\text{C}$ with no thermal runaway
- ◆ Typical I_R less than $0.1 \mu\text{A}$
- ◆ Hermetically sealed package
- ◆ High temperature soldering guaranteed: $350^\circ\text{C}/10$ seconds/.375" (9.5mm) lead length at 5 lbs., (2.3kg) tension



MECHANICAL DATA

Case: One piece glass, hermetically sealed
Terminals: Plated Axial leads, solderable per MIL-STD-202, Method 208
Polarity: Color band denotes cathode
Mounting Position: Any
Weight: .037 ounce, 1.04 grams

MAXIMUM RATINGS AND ELECTRICAL CHARACTERISTICS

Ratings at 25°C ambient temperature unless otherwise specified.
Resistive or inductive load. For capacitive load, derate current by 20%.

	SYMBOLS	RG4A	RG4B	RG4D	RG4G	RG4J	RG4K	RG4M	UNITS
Maximum Recurrent Peak Reverse Voltage	V_{RRM}	50	100	200	400	600	800	1000	Volts
Maximum RMS Voltage	V_{RMS}	35	70	140	280	420	560	700	Volts
Maximum DC Blocking Voltage	V_{DC}	50	100	200	400	600	800	1000	Volts
Maximum Average Forward Rectified Current .375", (9.5mm) Lead Lengths at $T_A = 50^\circ\text{C}$	$I_{(AV)}$	3.0							Amps
Peak Forward Surge Current 8.3ms single half sine-wave superimposed on rated load (JEDEC Method)	I_{FSM}	100							Amps
Maximum Instantaneous Forward Voltage at 3.0A	V_F	1.3							Volts
Maximum Reverse Current at Rated DC Blocking Voltage, $T_A = 25^\circ\text{C}$	I_R	5.0							μA
Maximum Average Reverse Current at Peak Reverse Voltage $T_A = 25^\circ\text{C}$	$I_{R(AV)}$	2.0							μA
Maximum Average Reverse Current at Peak Reverse Voltage $T_A = 100^\circ\text{C}$	$I_{R(AV)}$	100							μA
Typical Junction Capacitance (Note 2)	C_J	50.0							pf
Maximum Reverse Recovery Time (Note 1) $T_J = 25^\circ\text{C}$	T_{RR}	150			250	500	500		nS
Typical Thermal Resistance (Note 3)	$R_{\theta JA}$	17.0							$^\circ\text{C}/\text{W}$
Operating and Storage Temperature Range	T_J, T_{STG}	-65 to +175							$^\circ\text{C}$

NOTES:

1. Reverse Recovery Test Conditions : $I_F = 0.5\text{A}$, $I_R = 1.0\text{A}$, $I_{rr} = 25\text{A}$.
2. Measured at 1 MHz and applied reverse voltage of 4.0 volts.
3. Thermal Resistance from Junction to Ambient at .375" (9.5mm) Lead Lengths, with both leads to heat sink.

RATINGS AND CHARACTERISTIC CURVES RG4A THRU RG4M

Fig. 1 — FORWARD CURRENT DERATING CURVE

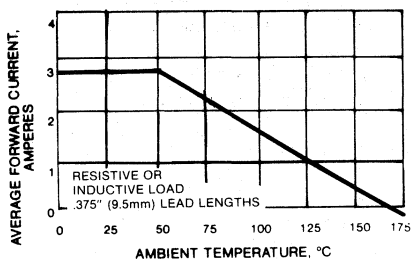

FIG. 2 — MAXIMUM NON-REPETITIVE PEAK FORWARD SURGE CURRENT

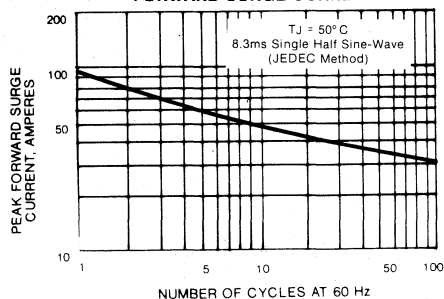

Fig. 3 — TYPICAL INSTANTANEOUS FORWARD CHARACTERISTICS

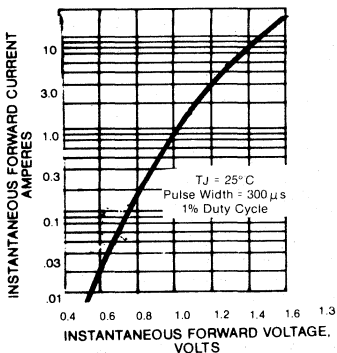

Fig. 4 — TYPICAL JUNCTION CAPACITANCE

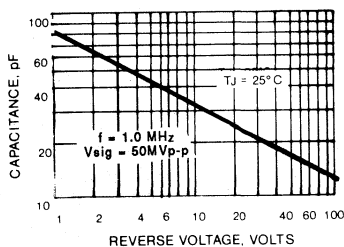

Fig. 5 — TYPICAL REVERSE CHARACTERISTICS

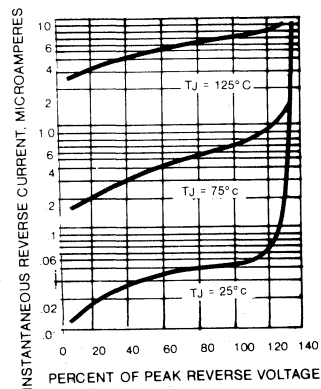
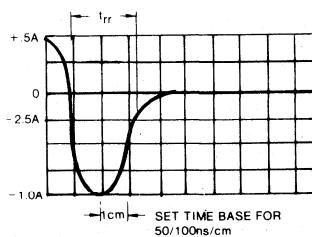
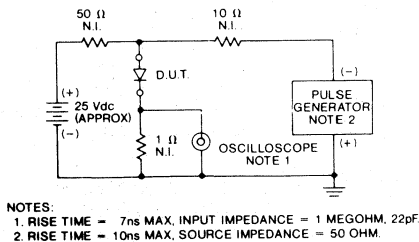

Fig. 6 — TEST CIRCUIT DIAGRAM AND REVERSE RECOVERY TIME CHARACTERISTICS



BYW72 THRU BYW76

FAST SWITCHING GLASS PASSIVATED SILICON RECTIFIER

Voltage - 200 to 600 Volts **Current - 3.0 Amperes**

FEATURES

- ◆ High temperature metallurgically bonded constructed rectifiers
- ◆ Glass passivated cavity-free junction
- ◆ Hermetically sealed package
- ◆ 3.0 Ampere operation at $T_A = 45^\circ\text{C}$ with no thermal runaway
- ◆ Typical I_R less than $0.1 \mu\text{A}$
- ◆ Capable of meeting environmental standards of MIL-S-19500
- ◆ High temperature soldering guaranteed $350^\circ\text{C}/10$ seconds/.375", (9.5mm) lead length at 5 lbs., (2.3kg) tension

PATENTED*

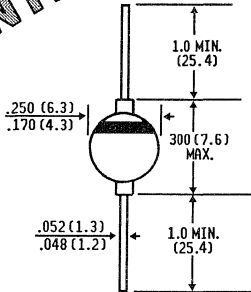

Dimension in inches
and
(millimeters)

*Braze-lead assembly is covered by Patent No. 3,930,306 of 1976 and glass composition by Patent No.3,752,701 of 1973

MECHANICAL DATA

Case: One piece glass, hermetically sealed
Terminals: Plated Axial leads, solderable per MIL-STD-202, Method 208
Polarity: Color band denotes cathode
Mounting Position: Any
Weight: .04 ounce, 1.1gram

MAXIMUM RATINGS AND ELECTRICAL CHARACTERISTICS

Ratings at 25°C ambient temperature unless otherwise specified.
Resistive or inductive load. For capacitive load, derate current by 20%.

	SYMBOLS	BYW72	BYW73	BYW74	BYW75	BYW76	UNITS
Maximum Recurrent Peak Reverse Voltage	V_{RRM}	200	300	400	500	600	Volts
Maximum RMS Voltage	V_{RMS}	140	210	280	350	420	Volts
Maximum DC Blocking Voltage	V_{DC}	200	300	400	500	600	Volts
Maximum Average Forward Rectified Current .375", (9.5mm) Lead Lengths at $T_A = 45^\circ\text{C}$	$I_{(AV)}$	3.0					Amps
Peak Forward Surge Current 10ms single half sine-wave superimposed on rated load	I_{FSM}	60.0					Amps
Maximum Instantaneous Forward Voltage at 3.0A	V_F	1.1					Volts
Maximum Average Reverse Current at Rated Peak Reverse Voltage $T_A = 100^\circ\text{C}$	$I_{R(AV)}$	50.0					μA
Maximum DC Reverse Current at Rated DC Blocking Voltage $T_A = 25^\circ\text{C}$	I_R	5.0					μA
Maximum Reverse Recovery Time (Note 1) $T_J = 25^\circ\text{C}$	T_{RR}	200					nS
Typical Junction Capacitance (Note 2)	C_J	40.0					pf
Typical Thermal Resistance (Note 3)	$R_{\theta JC}$	22.0					$^\circ\text{C/W}$
Operating Temperature Range	T_J	-65 to +175					$^\circ\text{C}$
Storage Temperature Range	T_{STG}	-65 to +300					$^\circ\text{C}$

NOTES:

1. Reverse Recovery Test Conditions : $I_F = 0.5\text{A}$, $I_R = 1.0\text{A}$, $I_{rr} = 25\text{A}$.
2. Measured at 1 MHz and applied reverse voltage of 4.0 V_{DC} .
3. Thermal Resistance from Junction to Ambient at .375" (9.5mm) Lead Lengths, with both leads attached to heat sink.

RATING AND CHARACTERISTIC CURVES BYW72 THRU BYW76

FIG. 1 — FORWARD RECTIFIED CURRENT DERATING CURVE

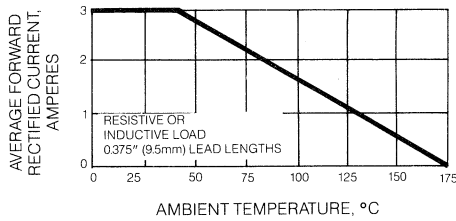

FIG. 3 — TYPICAL JUNCTION CAPACITANCE

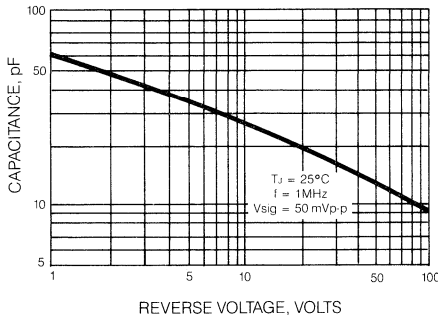

FIG. 5 — TYPICAL REVERSE CHARACTERISTICS

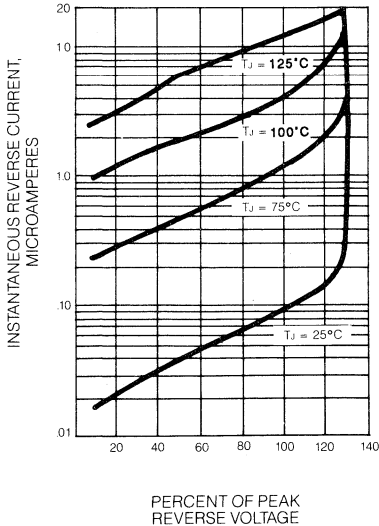

FIG. 2 — MAXIMUM NON-REPETITIVE PEAK FORWARD SURGE CURRENT

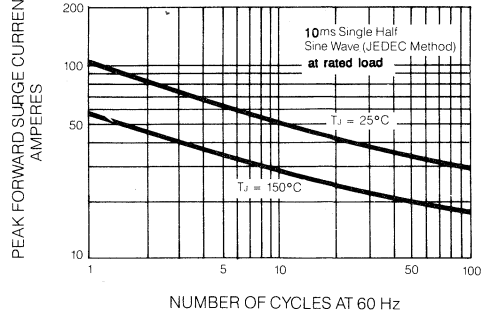

FIG. 4 — TYPICAL INSTANTANEOUS FORWARD CHARACTERISTICS

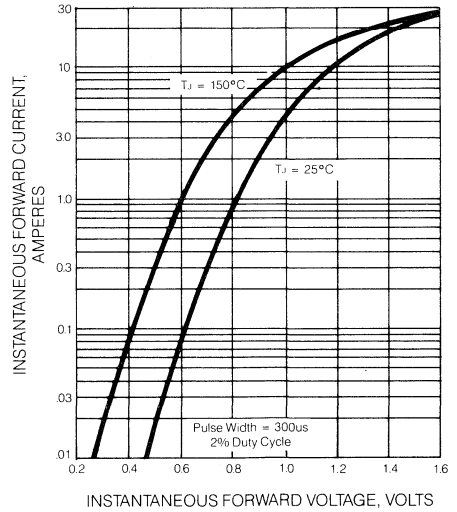
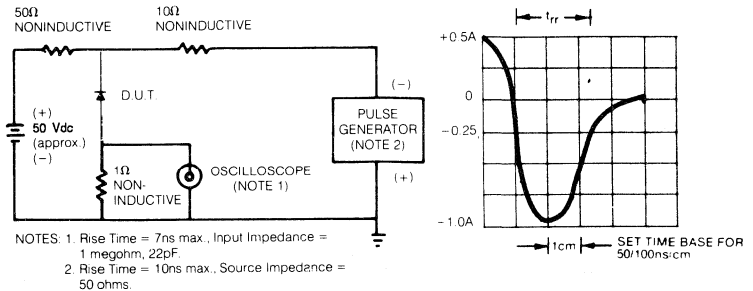

FIG. 6 — REVERSE RECOVERY TIME CHARACTERISTIC AND TEST CIRCUIT DIAGRAM



PLASTIC RECTIFIERS

1.0 AMPERE TO 25.0 AMPERES
50 to 1000 Volts

**GENERAL
INSTRUMENT**

PLASTIC RECTIFIER

1.0 to 25 Amperes 50 Volts to 1000 Volts

Principle of Construction

General Instrument has produced successfully for many years Plastic Rectifiers. The key factor of our Plastic Rectifiers is the use of the cell concept.

The small size allows many cells to be processed simultaneously in batch form.

This method ensures accurate pretesting of the cells before final assembly, and allows General Instrument to produce high volume of Rectifiers economically.

The cell construction consists of the following steps:

1—Diffusing a PN junction into a slice of silicon.

Diffused Slice

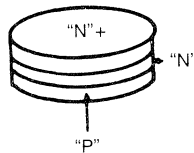

2—Metallizing the slice of silicon.

Metallized Slice

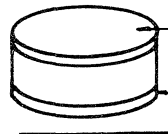

Gold and
Nickel Plating

3 - Scribing and breaking the slice into individual dies,
for the 1.0 Ampere devices we use a sandblast technology
for the 3.0 thru 25.0 Ampere devices we use a saw technology.

Scribed Wafer

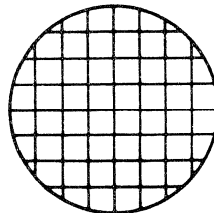

Sandblasted Round Dice

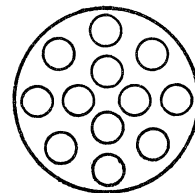

GENERAL
INSTRUMENT

PLASTIC RECTIFIERS

4—Soldering the die between two Double Nail Head Leads.

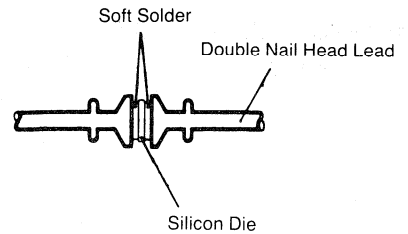

Soldering die between Double Nail Head Lead

5—Cleaning the assembly by chemical etching, washing and drying.

6—Passivating the finished rectifier with silastic.

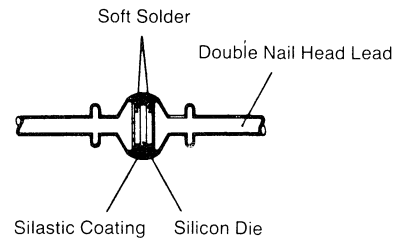

7—Overmolding by General Instrument proprietary 4B flame retardant molding compound.

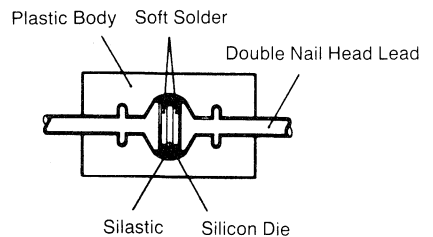

8—Lead tinning, electrical testing marking and packing.

Double Nail Head Plastic Rectifier

FAMILIES OF GENERAL INSTRUMENT PLASTIC RECTIFIERS

Miniature Plastic Silicon Rectifiers 1.0 to 1.5 AMPERES

Types: 1N4001 thru 1N4007
M100A thru M100M
1N5391 thru 1N5399

Features:

- ◆ Low Cost
- ◆ Diffused Junction
- ◆ Low Leakage
- ◆ High Current Capability
- ◆ Easily Cleaned with Freon, Alcohol, Chlorothene and similar Solvents
- ◆ Tin Plated Axial Leads, Solderable per MIL-STD-202/208
- ◆ Case: Jeduc DO 41
- ◆ High Temperature Soldering Guaranteed 265°C/10 Seconds/.375", 10mm Lead Length at 2.25 kg Tension

Plastic Power Rectifiers 3.0 to 6.0 AMPERES

Types: 1N5400 thru 1N5408
P300A thru P300M
G1500 thru G1510
G1750 thru G1758
P600A thru P600M

Features:

- ◆ High Surge Current Capability
- ◆ Void-Free Plastic Packages
- ◆ High Current Operation
- ◆ Typical I_r less than $1\mu A$
- ◆ High Temperature Soldering Guaranteed 265°C/10 Seconds/.375", 10mm Lead Length at 2.25 kg Tension
- ◆ Tin Plated Axial Leads, Solderable per MIL-STD-202/208

High Current Silicon Rectifiers 8.0 to 25.0 AMPERES

Types: NS8AT thru NS8MT
NP16AT thru NP16MT
AR25A thru AR25M
ARS25A thru ARS25M

Features:

- ◆ High Surge Capability
- ◆ High Current Capability
- ◆ Low Forward Voltage
- ◆ Low Leakage

Fast Recovery Plastic Silicon Rectifiers 1.0 to 8.0 AMPERES

Types: BY396B thru BY399B 1N4933 thru 1N4937
BY500-100 thru BY500-800 RS8AT thru RS8MT
G1820 thru G1826 SRP100A thru SRP100K
G1850 thru G1856 SRP300A thru SRP300K
G1910 thru G1917 SRP600A thru SRP600K

Features:

- ◆ High Surge Current Capability
- ◆ Void-Free Plastic Packages
- ◆ High Current Operation
- ◆ Typical I_r less than $1\mu A$
- ◆ High Temperature Soldering Guaranteed 265°C/10 Seconds/.375", 10mm Lead Length at 2.25 kg Tension
- ◆ Controlled Soft Recovery Guarantees low RFI and high Efficiency Switching Characteristics of
- ◆ SRP100A thru SRP100K, SRP300A thru SRP300K, BY296P thru BY299P, BY500-100 thru BY500-800 and SRP600A thru SRP600K
- ◆ Tin Plated Axial Leads, Solderable per MIL-STD-202/208

QUICK GUIDE TO PLASTIC RECTIFIERS

TYPE	1N4001 thru 1N4007	M100A thru M100M	1N4933* thru 1N4937*	SRP100A* thru SRP100K*	BYX55-350P* and BYX55-600P*	1N5391 thru 1N5399	BY296P* thru BY299P*	1N5400 thru 1N5408	P300A thru P300M	GI500 thru GI510	GI910* thru GI917*	GI850* thru GI856*	SRP300A* thru SRP300K	BY396P* thru BY399P*
CASE	DO41	DO41	DO41	DO41	DO201AD	DO41	DO201AD	DO201AD	DO201AD	DO201AD	DO201AD	DO201AD	DO201AD	DO201AD
I_o (A)	1.0	1.0	1.0	1.0	1.2	1.5	2.0	3.0	3.0	3.0	3.0	3.0	3.0	3.0
@ T_A (°C)	75	100	75	55	55	75 at T_c	55	105	105	95	90	90	55	50
$V_R = 50$ (V)	1N4001	M100A	1N4933	SRP100A		1N5391		1N5400	P300A	GI500	GI910	GI850	SRP300A	
$V_R = 100$ (V)	1N4002	M100B	1N4934	SRP100B		1N5392	BY296P	1N5401	P300B	GI501	GI911	GI851	SRP300B	BY396P
$V_R = 200$ (V)	1N4003	M100D	1N4935	SRP100D		1N5393	BY297P	1N5402	P300D	GI502	GI912	GI852	SRP300D	BY397P
$V_R = 300$ (V)						1N5394		1N5403						
$V_R = 400$ (V)	1N4004	M100G	1N4936	SRP100G	BYX55-350P	1N5395	BY298P	1N5404	P300G	GI504	GI914	GI854	SRP300G	BY398P
$V_R = 500$ (V)						1N5396		1N5405						
$V_R = 600$ (V)	1N4005	M100J	1N4937	SRP100J		1N5397		1N5406	P300J	GI506	GI916	GI856	SRP300J	
$V_R = 800$ (V)	1N4006	M100K		SRP100K	BYX55-600P	1N5398	BY299P	1N5407	P300K	GI508	GI917		SRP300K	BY399P
$V_R = 1000$ (V)	1N4007	M100M				1N5399		1N5408	P300M	GI510				
$V_R > 1000$ (V)														
SURGE (A)	30	50	30	30	40	50	70	200	200	100	100	100	150	100
V_F (V)	1.1	1.0/1.1	1.2	1.3	1.25	1.4	1.3	1.2	1.1	1.1	1.25	1.25	1.3	1.25

*Fast Recovery

QUICK GUIDE TO PLASTIC RECTIFIERS

TYPE	BY500-100* thru BY500-800*	GI750 thru GI758	P600A thru P600M	GI820* thru GI826*	SRP600A* thru SRP600K*	NS8AT thru NS8MT	RS8AT* thru RS8KT*	NP16AT thru NP16KT	AR25A thru AR25M
CASE	DO201AD	P600	P600	P600	P600	TO220	TO220	TO220CT	AR25
I_o (A)	5.0	6.0	6.0	5.0	6.0	8.0	8.0	16	25.0
@ T_A (°C)	45	60	60	55	55	100 T_c	100 T_c	100 T_c	150 T_c
$V_R = 50$ (V)		GI750	P600A	GI820	SRP600A	NS8AT	RS8AT	NP16AT	AR25A
$V_R = 100$ (V)	BY500-100	GI751	P600B	GI821	SRP600B	NS8BT	RS8BT	NP16BT	AR25B
$V_R = 200$ (V)	BY500-200	GI752	P600D	GI822	SRP600D	NS8DT	RS8DT	NP16DT	AR25D
$V_R = 400$ (V)	BY500-400	GI754	P600G	GI824	SRP600G	NS8GT	RS8GT	NP16GT	AR25G
$V_R = 600$ (V)	BY500-600	GI756	P600J	GI826	SRP600J	NS8JT	RS8JT	NP16JT	AR25J
$V_R = 800$ (V)	BY500-800	GI758	P600K		SRP600K	NS8KT	RS8KT	NP16KT	AR25K
$V_R = 1000$ (V)			P600M			NS8MT	RS8MT	NP16MT	AR25M
$V_R > 1000$ (V)									
SURGE (A)	200	400	400	300	300	175	150	300	400
V_F (V)	1.35	.9/95	.9/1.0	1.0	1.3	1.1	1.3	1.1	1.0

*Fast Recovery

**GENERAL
INSTRUMENT**

1N4001 THRU 1N4007

MINIATURE PLASTIC SILICON RECTIFIER
VOLTAGE - 50 to 1000 Volts CURRENT - 1.0 Ampere

FEATURES

DO-41

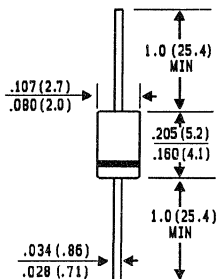

Dimension in inches
and
millimeters)

- ◆ The plastic package carries Underwriters Laboratory Flammability Classification 94V-O
- ◆ Low cost construction utilizing void-free molded plastic technique
- ◆ Low cost
- ◆ Diffused junction
- ◆ Low leakage
- ◆ High current capability
- ◆ Easily cleaned with Freon, Alcohol, Chloroethene and similar solvents
- ◆ High temperature soldering guaranteed: 265°C/10 seconds/.375", (9.5mm) lead lengths at 5 lbs., (2.3kg) tension

MECHANICAL DATA

Case: JEDEC DO-41, molded plastic case

Terminals: Plated axial leads, solderable per MIL-S-202, Method 208

Polarity: Color band denotes cathode end

Weight: 0.012 ounce, 0.3 gram

Mounting Position: Any

Handling precautions: None

MAXIMUM RATINGS AND ELECTRICAL CHARACTERISTICS

Ratings at 25°C ambient temperature unless otherwise specified
 Single phase, half wave, 60 Hz, resistive or inductive load.
 For capacitive load, derate current by 20%.

		1N 4001	1N 4002	1N 4003	1N 4004	1N 4005	1N 4006	1N 4007	UNITS
*Maximum Recurrent Peak Reverse Voltage	V _{RRM}	50	100	200	400	600	800	1000	Volts
*Maximum RMS Voltage	V _{RMS}	35	70	140	280	420	560	700	Volts
*Maximum DC Blocking Voltage	V _{DC}	50	100	200	400	600	800	1000	Volts
*Maximum Average Forward Rectified Current .375", (9.5mm) lead lengths at T _A = 75°C	I _(AV)	1.0							Amps
*Peak Forward Surge Current 8.3ms single half sine-wave superimposed on rated load (JEDEC Method)	I _{FSM}	30.0							Amps
*Maximum Instantaneous Forward Voltage at 1.0A	V _F	1.1							Volts
*Maximum Full Load Reverse Current Full Cycle Average .375", (9.5mm) lead lengths at T _L = 75°C	I _{R(AV)}	30.0							μA
*Maximum DC Reverse Current T _A = 25°C at Rated DC Blocking Voltage T _A = 100°C	I _R	50.0							μA
Typical Reverse Recovery Time (Note 1) T _A = 25°C	T _{RR}	30.0							μs
Typical Junction Capacitance (Note 2) T _J = 25°C	C _J	15.0							pf
Typical Thermal Resistance (Note 3)	R _{ΘJA}	26.0							°C/W
*Operating and Storage Temperature Range,	T _J , T _{STG}	-50 to +175							°C

NOTES:

1. Measured on Tektronix Type "S" recovery plug-in. Tedtronix 545 Scope or equivalent, IFM = 20mA, IRM = 1mA
 2. Measured at 1.0 MHz and applied reverse voltage of 4.0 Volts.
 3. Thermal Resistance from Junction to Ambient at 375" (9.5mm) lead lengths, P.C. Board mounted.
- *JEDEC Registered Value

RATINGS AND CHARACTERISTIC CURVES 1N4001 THRU 1N4007

FIG. 1 — FORWARD CURRENT DERATING CURVE

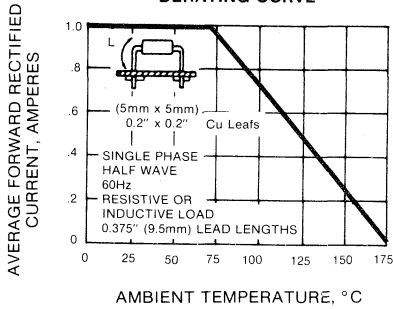

FIG. 2 — TYPICAL FORWARD CHARACTERISTICS

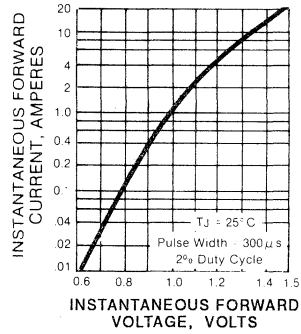

FIG. 3 — MAXIMUM NON-REPETITIVE PEAK FORWARD SURGE CURRENT

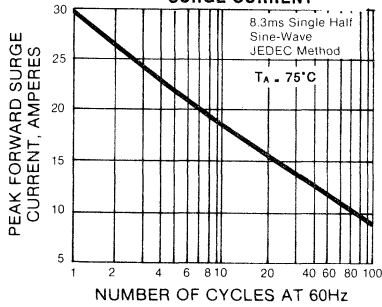

FIG. 4 — PEAK FORWARD SURGE CURRENT

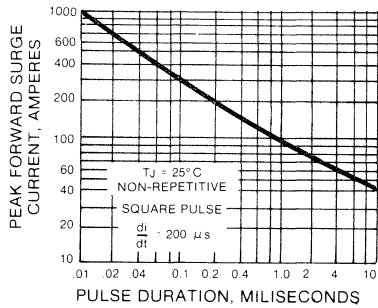

FIG. 5 — TYPICAL JUNCTION CAPACITANCE

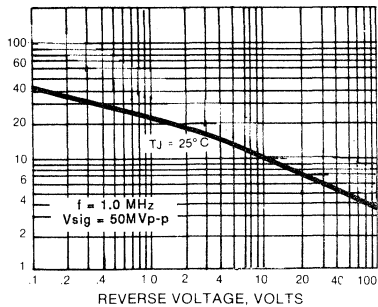
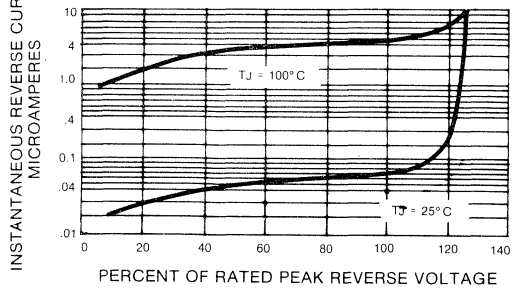

FIG. 6 — TYPICAL REVERSE CHARACTERISTICS



1N4001P THRU 1N4007P

MINIATURE PLASTIC SILICON RECTIFIER
VOLTAGE - 50 to 1000 Volts CURRENT - 1.0 Ampere

FEATURES

- ◆ The plastic package carries Underwriters Laboratory Flammability Classification 94V-0
- ◆ Void-free molded plastic construction
- ◆ Low cost
- ◆ Diffused junction
- ◆ Low leakage
- ◆ High surge current capability
- ◆ Easily cleaned with Freon, Alcohol, Chloroethene and similar solvents
- ◆ High temperature soldering guaranteed: 265°C/10 seconds/.375", (9.5mm) lead lengths at 5 lbs., (2.3kg) tension

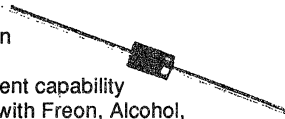

DO-41 MODIFIED

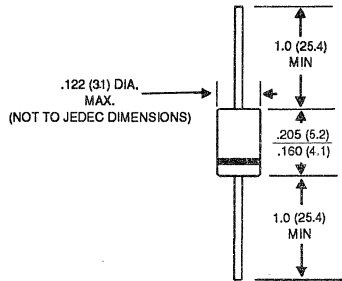

Dimension in inches
and
(millimeters)

MECHANICAL DATA

Case: DO-41 modified case

Terminals: Plated axial leads, solderable per MIL-STD-202, Method 208

Polarity: Color band denotes cathode end

Weight: 0.012 ounce, 0.3 gram

Mounting Position: Any

Handling Precautions: None

MAXIMUM RATINGS AND ELECTRICAL CHARACTERISTICS

Ratings at 25°C ambient temperature unless otherwise specified
 Single phase, half wave, 60 Hz, resistive or inductive load.
 For capacitive load, derate current by 20%.

	SYMBOLS	1N 4001P	1N 4002P	1N 4003P	1N 4004P	1N 4005P	1N 4006P	1N 4007P	UNITS
*Maximum Recurrent Peak Reverse Voltage	V _{RRM}	50	100	200	400	600	800	1000	Volts
*Maximum RMS Voltage	V _{RMS}	35	70	140	280	420	560	700	Volts
*Maximum DC Blocking Voltage	V _{DC}	50	100	200	400	600	800	1000	Volts
*Maximum Average Forward Rectified Current .375", (9.5mm) lead lengths at T _A = 75°C	I _(AV)				1.0				Amps
*Peak Forward Surge Current 8.3ms single half sine-wave superimposed on rated load (JEDEC Method)	I _{FSM}				30.0				Amps
*Maximum Instantaneous Forward Voltage at 1.0A	V _F				1.1				Volts
*Maximum Full Load Reverse Current Full Cycle Average .375", (9.5mm) lead lengths at T _L = 75°C	I _R				30.0				μA
*Maximum DC Reverse Current T _A = 25°C at Rated DC Blocking Voltage T _A = 100°C	I _R				5.0				μA
Typical Reverse Recovery Time (Note 1) T _A = 25°C	T _{RR}				30.0				μs
Typical Junction Capacitance (Note 2) T _J = 25°C	C _J				30.0				pf
Typical Thermal Resistance (Note 3)	R _{θJA}				50.0				°C/W
*Operating and Storage Temperature Range,	T _J , T _{STG}				-50 to +175				°C

NOTES:

1. Measured on Tektronix Type "S" recovery plug-in. Tektronix 545 Scope or equivalent, IFM = 20mA, IRM = 1mA
 2. Measured at 1.0 MHz and applied reverse voltage of 4.0 Volts.
 3. Thermal Resistance from Junction to Ambient at .375" (9.5mm) lead lengths, P.C. Board mounted.
- *JEDEC Registered Value

RATINGS AND CHARACTERISTIC CURVES 1N4001P THRU 1N4007P

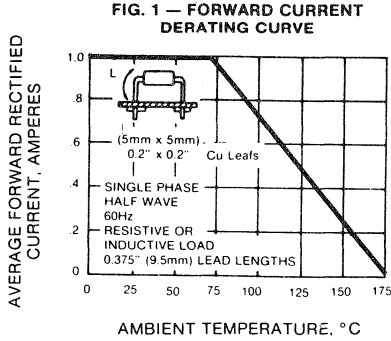

FIG. 2 — TYPICAL FORWARD CHARACTERISTICS

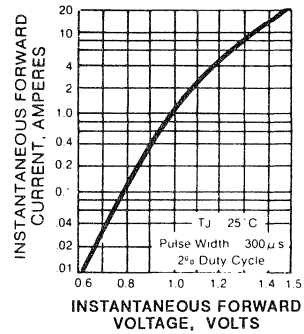

FIG. 3 — MAXIMUM NON-REPETITIVE PEAK FORWARD SURGE CURRENT

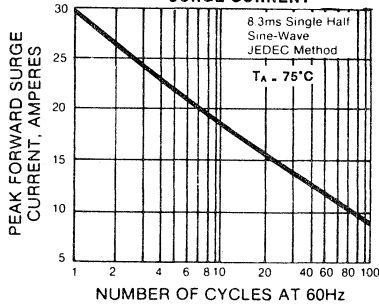

FIG. 4 — PEAK FORWARD SURGE CURRENT

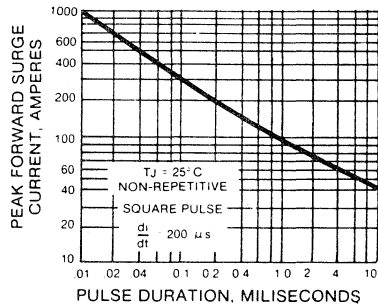

FIG. 5 — TYPICAL JUNCTION CAPACITANCE

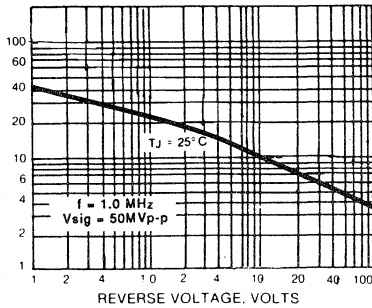
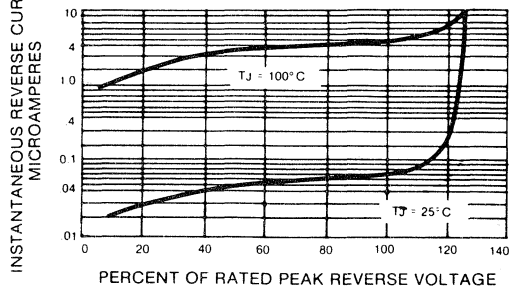

FIG. 6 — TYPICAL REVERSE CHARACTERISTICS



M100A THRU M100M

MINIATURE PLASTIC SILICON RECTIFIER
VOLTAGE - 50 to 1000 Volts CURRENT - 1.0 Ampere

FEATURES

- ◆ The plastic package carries Underwriters Laboratory Flammability Classification 94V-0
- ◆ Low cost construction utilizing void-free molded plastic technique
- ◆ Low cost
- ◆ Diffused junction
- ◆ Low leakage
- ◆ High surge capability
- ◆ High temperature soldering guaranteed: 265°C/10 seconds/.375" (9.5mm) lead lengths at 5 lbs., (2.3kg) tension

DO-41

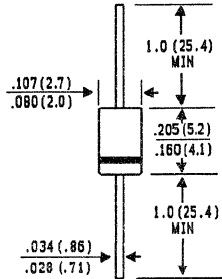

*Dimensions in inches
and
(millimeters)*

MECHANICAL DATA

Case: JEDEC DO-41, molded plastic case
Terminals: Plated axial leads, solderable per MIL-ST-202, Method 208
Polarity: Color band denotes cathode end
Weight: 0.012 ounce, 0.3 gram
Mounting Position: Any

MAXIMUM RATINGS AND ELECTRICAL CHARACTERISTICS

Ratings at 25°C ambient temperature unless otherwise specified
 Single phase, half wave, 60 Hz, resistive or inductive load.
 For capacitive load, derate current by 20%.

		M100 SYMBOLS	M100 A	M100 B	M100 D	M100 G	M100 J	M100 K	M100 M	UNITS
Maximum Recurrent Peak Reverse Voltage	V _{RRM}	50	100	200	400	600	800	1000		Volts
Maximum RMS Voltage	V _{RMS}	35	70	140	280	420	560	700		Volts
Maximum DC Blocking Voltage	V _{DC}	50	100	200	400	600	800	1000		Volts
Maximum Average Forward Rectified Current .375", (9.5mm) lead lengths at T _A = 100°C	I _(AV)	1.0								Amps
Peak Forward Surge Current 8.3ms single half sine-wave superimposed on rated load (JEDEC Method)	I _{FSM}	50.0								Amps
Maximum Instantaneous Forward Voltage at 1.0A	V _F	1.0						1.1		Volts
Maximum Full Load Reverse Current Full Cycle Average .375", (9.5mm) lead lengths at T _A = 55°C	I _{R(AV)}	100								µA
Maximum DC Reverse Current T _A = 25°C at Rated DC Blocking Voltage T _A = 100°C	I _R	1.0								µA
Typical Reverse Recovery Time (Note 2)	T _{RR}	2.0								µs
Typical Junction Capacitance (Note 1) T _J = 25°C	C _J	30.0								pf
Typical Thermal Resistance (Note 3)	R _{θJA}	26.0								°C/W
Operating and Storage Temperature Range	T _J , T _{STG}	-50 to +150								°C

NOTES:

1. Measured at 1.0 MHz and applied reverse voltage of 4.0 VDC.
2. Measured with I_F = 0.5A, I_R = 1.0A, I_{rr} = .25A
3. Thermal Resistance from Junction to Ambient at .375" (9.5mm) lead lengths, P.C. Board mounted.

RATINGS AND CHARACTERISTIC CURVES M100A THRU M100M

FIG. 1 — FORWARD CURRENT DERATING CURVE

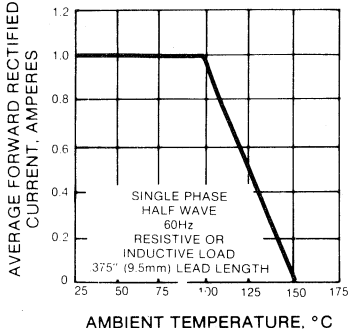

FIG. 2 — TYPICAL FORWARD CHARACTERISTICS

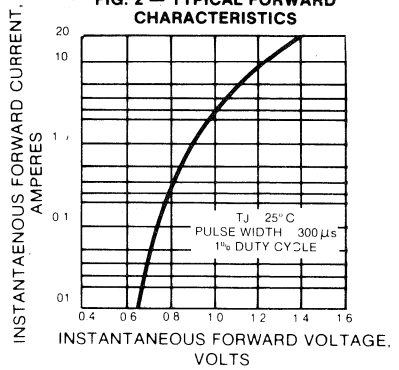

FIG. 3 — MAXIMUM NON-REPETITIVE PEAK FORWARD SURGE CURRENT

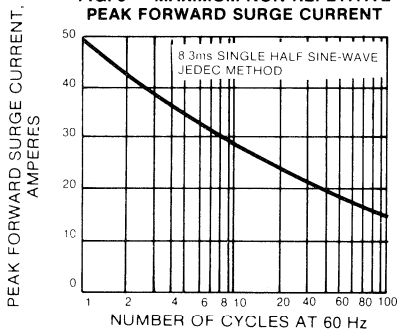

Fig. 4—TYPICAL JUNCTION CAPACITANCE

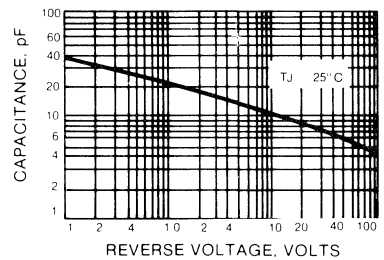
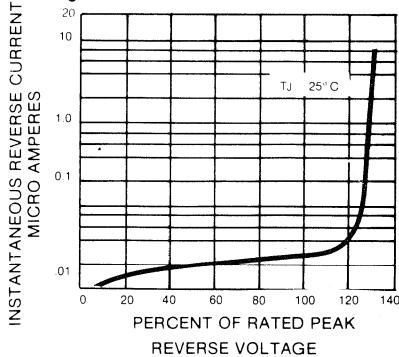

Fig. 5—TYPICAL REVERSE CHARACTERISTICS



1N5391 THRU 1N5399

MINIATURE PLASTIC SILICON RECTIFIER
VOLTAGE - 50 to 1000 Volts CURRENT - 1.5 Amperes

FEATURES

DO-41

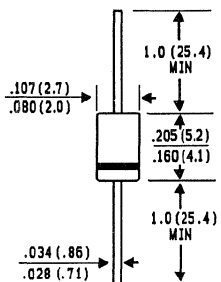

Dimensions in inches
and
millimeters

- ◆ High surge current capability
- ◆ The plastic package carries Underwriters Laboratory Flammability Classification 94V-0
- ◆ 1.5 Ampere operation at $T_L = 70^\circ\text{C}$ with no thermal runaway
- ◆ Typical I_R less than $0.1\mu\text{A}$
- ◆ Low cost construction utilizing void-free molded plastic technique
- ◆ High temperature soldering guaranteed: $265^\circ\text{C}/10$ seconds/.375", (9.5mm) lead length at 5 lbs., (2.3kg) tension



MECHANICAL DATA

Case: JEDEC DO-41, molded plastic case
Terminals: Plated axial leads, solderable per MIL-S-202, Method 208
Polarity: Color band denotes cathode end
Weight: 0.012 ounce, 0.3 gram
Mounting Position: Any

MAXIMUM RATINGS AND ELECTRICAL CHARACTERISTICS

Ratings at 25°C ambient temperature unless otherwise specified
 Single phase, half wave, 60 Hz, resistive or inductive load.
 For capacitive load, derate current by 20%.

	SYMBOLS	1N 5391	1N 5392	1N 5393	1N 5394	1N 5395	1N 5396	1N 5397	1N 5398	1N 5399	UNITS	
*Maximum Recurrent Peak Reverse Voltage	V_{RRM}	50	100	200	300	400	500	600	800	1000	Volts	
*Maximum RMS Voltage	V_{RMS}	35	70	140	210	280	350	420	560	700	Volts	
*Maximum DC Blocking Voltage	V_{DC}	50	100	200	300	400	500	600	800	1000	Volts	
*Maximum Average Forward Rectified Current .500, (12.7mm) lead lengths at $T_L = 70^\circ\text{C}$	$I_{(AV)}$										1.5	Amps
*Peak Forward Surge Current 8.3ms single half sine-wave superimposed on rated load (JEDEC Method)	I_{FSM}										50.0	Amps
*Maximum Instantaneous Forward Voltage at 1.5A, $T_A = 70^\circ\text{C}$	V_F										1.4	Volts
*Maximum DC Reverse Current $T_A = 25^\circ\text{C}$ at Rated DC Blocking Voltage $T_A = 150^\circ\text{C}$	I_R										5.0 300	μA
*Maximum Full Load Reverse Current Full Cycle Average, .375", (9.5mm) Lead Length at $T_L = 70^\circ\text{C}$	$I_{R(AV)}$										300	μA
Typical Reverse Recovery Time (Note 2)	T_{RR}										2.0	μs
Typical Junction Capacitance (Note 1)	C_J										15.0	pf
Typical Thermal Resistance (Note 3)	$R_{\theta JA}$										26.0	$^\circ\text{C}/\text{W}$
*Maximum DC Blocking Voltage Temperature	T_A										+150	$^\circ\text{C}$
*Operating Junction Temperature Range	T_J										-50 to +170	$^\circ\text{C}$
*Storage Temperature Range	T_{STG}										-50 to +175	$^\circ\text{C}$

NOTES: 1. Measured at 1.0 MHz and applied reverse voltage of 4.0 VDC.
 2. Measured with $I_F = 0.5\text{A}$, $I_R = 1.0\text{A}$, $I_{rr} = .25\text{a}$.
 3. Thermal Resistance from Junction to Ambient at .375" (9.5mm) lead lengths, P.C. Board mounted.
 *JEDEC Registered Value.

RATINGS AND CHARACTERISTIC CURVES 1N5391 THRU 1N5399

FIG. 1 — FORWARD CURRENT DERATING CURVE

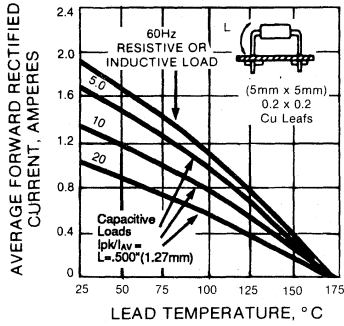

FIG. 2 — TYPICAL FORWARD CHARACTERISTICS

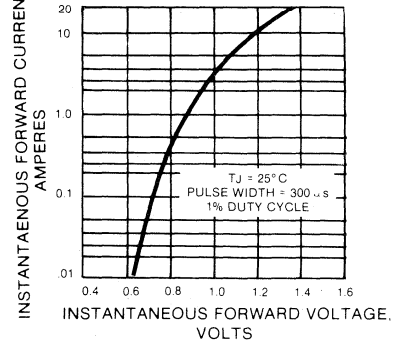

FIG. 3 — MAXIMUM NON-REPETITIVE PEAK FORWARD SURGE CURRENT

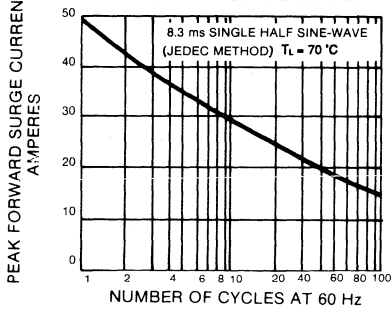

Fig. 4—TYPICAL JUNCTION CAPACITANCE

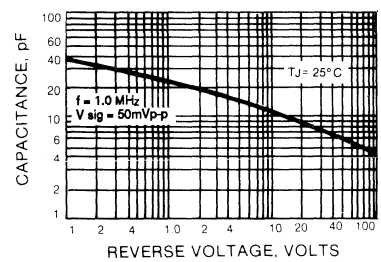
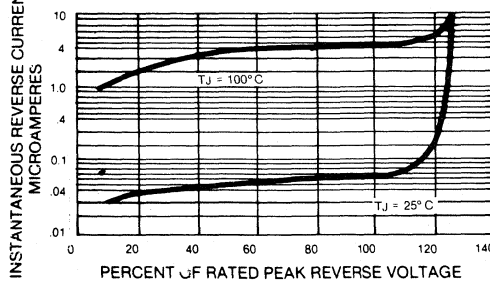

FIG. 5 — TYPICAL REVERSE CHARACTERISTICS



1N5400 THRU 1N5408

MEDIUM CURRENT SILICON RECTIFIER
VOLTAGE - 50 to 1000 Volts CURRENT - 3.0 Amperes

FEATURES

DO-201AD

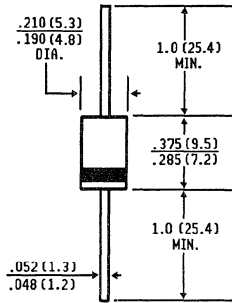

Dimensions in inches
and
(millimeters)

- ◆ High surge current capability
- ◆ The plastic package carries Underwriters Laboratory Flammability Classification 94V-0
- ◆ Void-free plastic in DO-201AD package
- ◆ 3.0 Ampere operation at $T_L = 105^\circ\text{C}$ with no thermal runaway
- ◆ Typical I_R less than $0.1\mu\text{A}$
- ◆ High temperature soldering guaranteed: $265^\circ\text{C}/10$ seconds/ $.375"$ (9.5mm) lead length at 5 lbs., (2.3kg) tension

MECHANICAL DATA

Case: JEDEC DO-201AD Molded plastic
Terminals: Plated Axial leads, solderable per MIL-S-202, Method 208
Polarity: Band denotes cathode
Weight: 0.04 ounce, 1.1 gram
Mounting Position: Any

MAXIMUM RATINGS AND ELECTRICAL CHARACTERISTICS

Ratings at 25°C ambient temperature unless otherwise specified
 Single phase, half wave, 60 Hz, resistive or inductive load.
 For capacitive load, derate current by 20%.

	SYMBOLS	1N 5400	1N 5401	1N 5402	1N 5403	1N 5404	1N 5405	1N 5406	1N 5407	1N 5408	UNITS
*Maximum Recurrent Peak Reverse Voltage	V_{RRM}	50	100	200	300	400	500	600	800	1000	Volts
*Maximum RMS Voltage	V_{RMS}	35	70	140	210	280	350	420	560	700	Volts
*Maximum DC Blocking Voltage to $T_A = 150^\circ\text{C}$	V_{DC}	50	100	200	300	400	500	600	800	1000	Volts
*Maximum Average Forward Rectified Current .5", (12.5mm) lead lengths at $T_L = 105^\circ\text{C}$	$I_{(AV)}$	3.0									Amps
*Peak Forward Surge Current 8.3ms single half sine-wave superimposed on rated load (JEDEC Method)	I_{FSM}	200									Amps
*Maximum Instantaneous Forward Voltage at 3.0A	V_F	1.2									Volts
* Maximum DC Reverse Current $T_A = 25^\circ\text{C}$ at Rated DC Blocking Voltage $T_A = 150^\circ\text{C}$	I_R	500									μA
*Maximum Full Load Reverse Current Full Cycle Average, .5", (12.5 mm) Lead Length at $T_L = 105^\circ\text{C}$	$I_{R(AV)}$	500									μA
Typical Junction Capacitance (Note 1) $T_J = 25^\circ\text{C}$	C_J	28.0									pf
*Typical Thermal Resistance (Note 2)	$R_{\theta JA}$	15.0									$^\circ\text{C}/\text{W}$
*Operating Junction Temperature Range	T_J	-50 to +170									$^\circ\text{C}$
*Storage Temperature Range,	T_{STG}	-50 to +175									$^\circ\text{C}$

NOTES:

1. Measured at 1.0 MHz and applied reverse voltage of 4.0 Volts.
 2. Thermal Resistance from Junction to Ambient at $.375"$ (9.5mm) lead lengths, P.C. Board mounted.
- *JEDEC Registered Value.

RATINGS AND CHARACTERISTIC CURVES 1N5400 THRU 1N5408

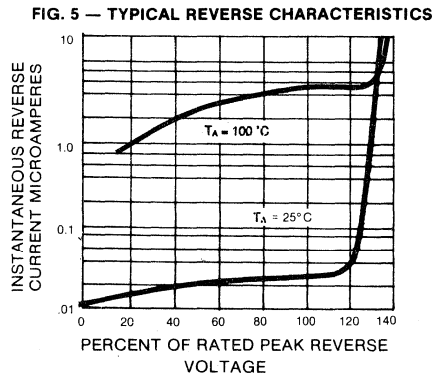
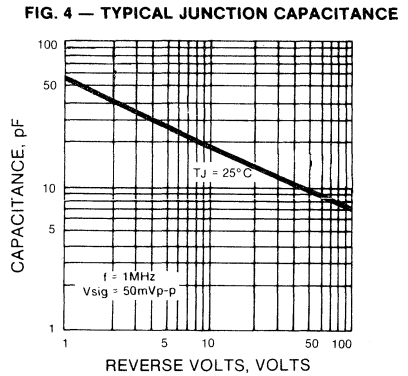
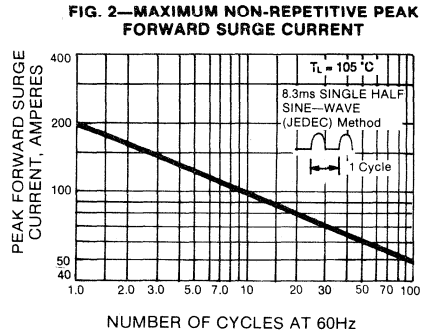
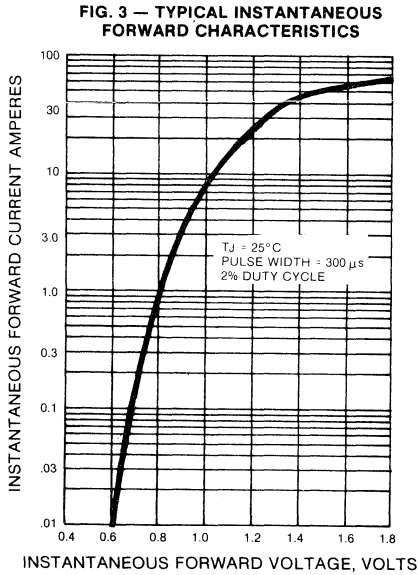
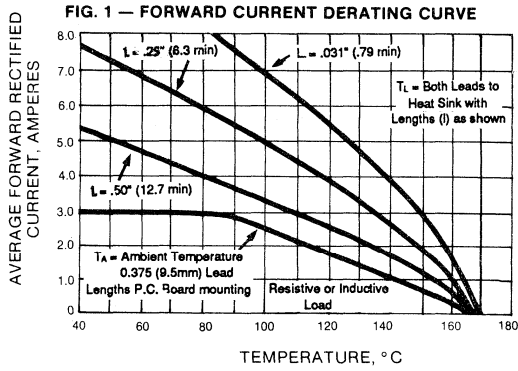

GI500 THRU GI510

MEDIUM CURRENT SILICON RECTIFIER
VOLTAGE - 50 to 1000 Volts CURRENT - 3.0 Amperes

FEATURES

- ◆ High surge current capability
- ◆ The plastic package carries Underwriters Laboratory Flammability Classification 94V-O
- ◆ Typical I_R less than $0.1 \mu A$
- ◆ Void-free DO-201AD package
- ◆ High current operation 3 Amperes at $T_A = 95^\circ C$
- ◆ High temperature soldering guaranteed: $265^\circ C/10$ seconds/.375", (9.5mm) lead lengths at 5 lbs., (2.3kg) tension

DO-201AD

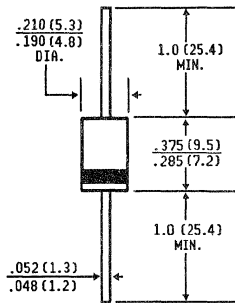

Dimensions in inches
and
(millimeters)

MECHANICAL DATA

Case: JEDEC D0-201AD Molded plastic

Terminals: Plated Axial leads, solderable per MIL-S-202, Method 208

Polarity: Band denotes cathode

Weight: 0.04 ounce, 1.1 gram

Mounting Position: Any

MAXIMUM RATINGS AND ELECTRICAL CHARACTERISTICS

Ratings at $25^\circ C$ ambient temperature unless otherwise specified
 Single phase, half wave, 60 Hz, resistive or inductive load.
 For capacitive load, derate current by 20%.

	SYMBOLS	GI 500	GI 501	GI 502	GI 504	GI 506	GI 508	GI 510	UNITS
Maximum Recurrent Peak Reverse Voltage	V_{RRM}	50	100	200	400	600	800	1000	Volts
Maximum RMS Voltage	V_{RMS}	35	70	140	280	420	560	700	Volts
Maximum DC Blocking Voltage	V_{DC}	50	100	200	400	600	800	1000	Volts
Maximum Average Forward Rectified Current .375", (9.5mm) lead lengths at $T_A = 95^\circ C$	$I_{(AV)}$	3.0							Amps
Peak Forward Surge Current 8.3ms single half sine-wave superimposed on rated load (JEDEC Method)	I_{FSM}	100							Amps
Maximum Instantaneous Forward Voltage at 9.4A $T_J = 25^\circ C$ $T_J = 175^\circ C$	V_F	1.1 1.0							Volts
Maximum DC Reverse Current at Rated DC Blocking Voltage $T_A = 25^\circ C$ $T_A = 100^\circ C$	I_R	5.0 50.0							μA
Typical Junction Capacitance (Note 2) $T_J = 25^\circ C$	C_J	28.0							pf
Typical Reverse Recovery Time (Note 3)	T_{RR}	2.5							μs
Typical Thermal Resistance (Note 1)	$R_{\theta JA}$	15.0							$^\circ C/W$
Operating and Storage Temperature Range	T_J, T_{STG}	-50 to +175							$^\circ C$

NOTES:

1. Thermal Resistance from Junction to applied at ambient .375" (9.5mm) lead lengths, P.C. Board mounted.
2. Measured at 1MHz and applied reverse voltage of 4.0 volts.
3. Reverse Recovery Test Conditions: $I_F = 0.5A$, $I_R = 1.0A$, $I_{rr} = 0.25A$

RATINGS AND CHARACTERISTIC CURVES G1500 THRU G1510

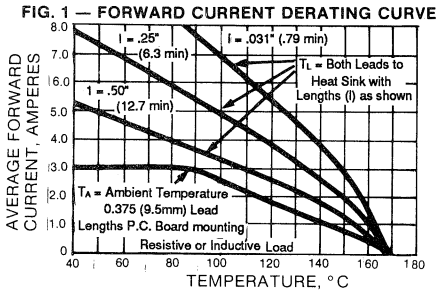

FIG. 3 — TYPICAL INSTANTANEOUS FORWARD CHARACTERISTICS

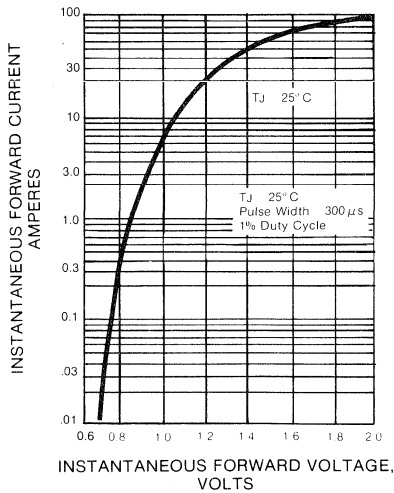

FIG. 2 — MAXIMUM PEAK FORWARD SURGE CURRENT

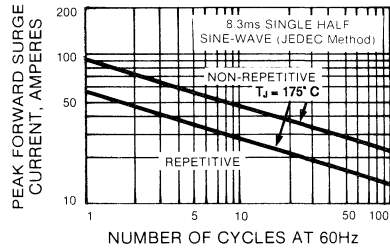

FIG. 4 — TYPICAL JUNCTION CAPACITANCE

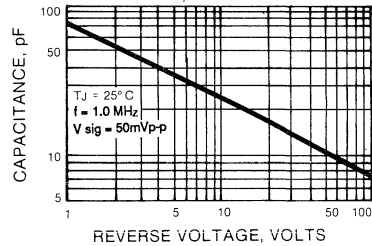
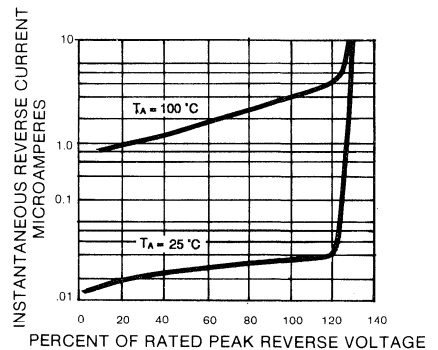

FIG. 5 — TYPICAL REVERSE CHARACTERISTICS



P300A THRU P300M

MEDIUM CURRENT SILICON RECTIFIER
VOLTAGE - 50 to 1000 Volts CURRENT - 3.0 Amperes

FEATURES

- ◆ High surge current capability
- ◆ The plastic package carries Underwriters Laboratory Flammability Classification 94V-0
- ◆ Typical I_R less than $0.1 \mu A$
- ◆ Void-free DO-201AD package
- ◆ 3.0 Ampere operation at $T_A = 90^\circ C$ with no thermal runaway
- ◆ High temperature soldering guaranteed: $265^\circ C/10$ seconds/.375"(.95mm) lead lengths at 5 lbs., (2.3kg) tension

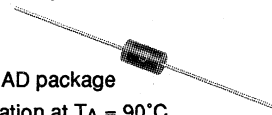

DO-201AD

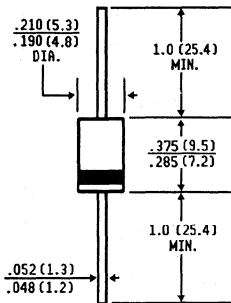

Dimensions in inches
and
(millimeters)

MECHANICAL DATA

Case: JEDEC DO-201AD Molded plastic
Terminals: Plated Axial leads, solderable per MIL-S-202, Method 208
Polarity: Band denotes cathode
Weight: 0.04 ounce, 1.1 gram
Mounting Position: Any

MAXIMUM RATINGS AND ELECTRICAL CHARACTERISTICS

Ratings at $25^\circ C$ ambient temperature unless otherwise specified
 Single phase, half wave, 60 Hz, resistive or inductive load.
 For capacitive load, derate current by 20%.

	SYMBOLS	P300 A	P300 B	P300 D	P300 G	P300 J	P300 K	P300 M	UNITS
Maximum Recurrent Peak Reverse Voltage	V_{RRM}	50	100	200	400	600	800	1000	Volts
Maximum RMS Voltage	V_{RMS}	35	70	140	280	420	560	700	Volts
Maximum DC Blocking Voltage	V_{DC}	50	100	200	400	600	800	1000	Volts
Maximum Average Forward Rectified Current .375", (9.5mm) lead lengths at $T_A = 90^\circ C$	$I_{(AV)}$	3.0							Amps
Peak Forward Surge Current 8.3ms single half sine-wave superimposed on rated load (JEDEC Method)	I_{FSM}	200							Amps
Maximum Instantaneous Forward Voltage at 3.0A $T_J = 25^\circ C$	V_F	1.2							Volts
Maximum DC Reverse Current at Rated DC Blocking Voltage $T_A = 25^\circ C$	I_R	5.0							μA
		25.0							μA
Typical Junction Capacitance (Note 1) $T_J = 25^\circ C$	C_J	28.0							pf
Typical Reverse Recovery Time (Note 2)	T_{RR}	2.5							μs
Typical Thermal Resistance (Note 3)	$R_{\theta JA}$	15.0							$^\circ C/W$
Operating and Storage Temperature Range	T_J, T_{STG}	-50 to +175							$^\circ C$

NOTES:

1. Measured at 1 MHz and applied reverse voltage of 4.0 Volts.
2. Reverse Recovery Test Conditions : $I_F = 0.5A, I_R = 1.0A, I_{rr} = .25A$
3. Thermal Resistance from Junction to Ambient at .375" (9.5mm) lead lengths, P.C. Board mounted.

RATINGS AND CHARACTERISTIC CURVES P300A THRU P300M

FIG. 1—FORWARD CURRENT DERATING CURVE

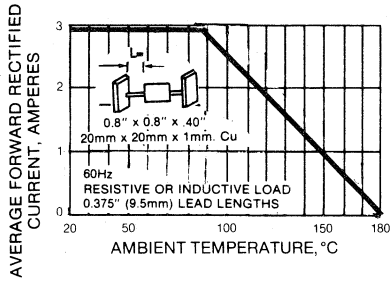

FIG. 3—TYPICAL INSTANTANEOUS FORWARD CHARACTERISTICS

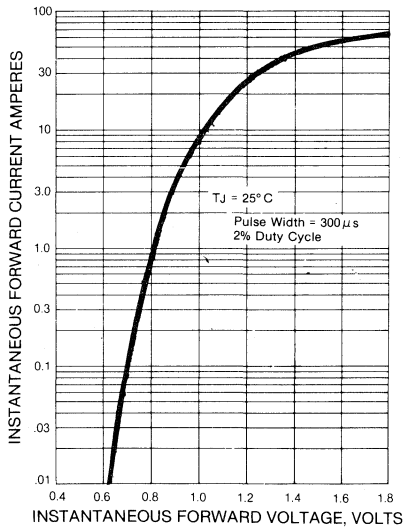

FIG. 2—MAXIMUM NON-REPETITIVE PEAK FORWARD SURGE CURRENT

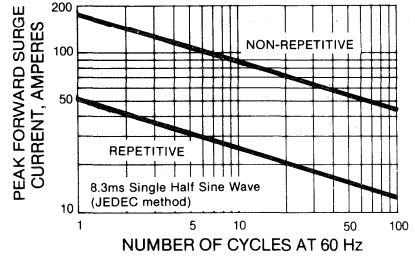

FIG. 4—TYPICAL JUNCTION CAPACITANCE

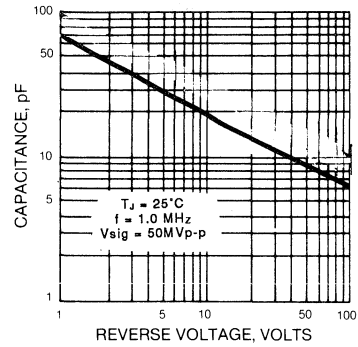
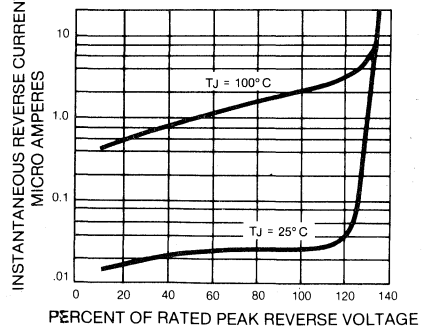

FIG. 5—TYPICAL REVERSE CHARACTERISTICS



GI750 THRU GI758

HIGH CURRENT PLASTIC SILICON RECTIFIER
VOLTAGE - 50 to 800 Volts CURRENT - 6.0 Amperes

FEATURES

- ◆ The plastic package carries Underwriters Laboratory Flammability Classification 94V-O
- ◆ High Current Capability
- ◆ Diffused Junction
- ◆ Completely Insulated Case
- ◆ Uniform Molded Body
- ◆ High temperature soldering guaranteed:
265°C/10 seconds/.375"(.95mm) lead lengths at 5 lbs., (2.3kg) tension

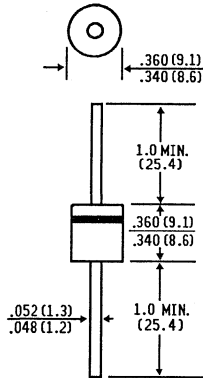

Dimensions in inches
and
(millimeters)

MECHANICAL DATA

Case: Molded plastic

Terminals: Plated Axial leads, solderable per MIL-STD -202, Method 208

Polarity: Band denotes cathode

Weight: 0.07 ounce, 2.1 gram

Mounting Position: Any

MAXIMUM RATINGS AND ELECTRICAL CHARACTERISTICS

Ratings at 25°C ambient temperature unless otherwise specified.
Single phase, half wave, 60 Hz, resistive or inductive load.
For capacitive load, derate current by 20%.

	SYMBOLS	GI750	GI751	GI752	GI754	GI756	GI758	UNITS
Maximum Recurrent Peak Reverse Voltage	V _{RRM}	50	100	200	400	600	800	Volts
Maximum RMS Voltage	V _{RMS}	35	70	140	280	420	560	Volts
Maximum DC Blocking Voltage	V _{DC}	50	100	200	400	600	800	Volts
Maximum Average Forward Rectified Current at T _A = 60°C P.C. Board Mounting (Fig. 1) T _L = 60°C .125", (3.18mm) Lead Lengths (Fig. 2)	I _(AV)	6.0 22.0						Amps
Peak Forward Surge Current 8.3ms single half sine-wave superimposed on rated load (JEDEC Method)	I _{FSM}	400						Amps
Maximum Instantaneous Forward Voltage at 6.0A 100A	V _F	0.90 1.25				0.95 1.30		Volts
Maximum DC Reverse Current at Rated DC Blocking Voltage	I _R	5.0 1.0						μA mA
Typical Thermal Resistance (Note 1)	RθJL	10.0						°C/W
Operating and Storage Temperature Range	T _J , T _{STG}	-50 to +175						°C

NOTES:

1. Thermal Resistance from Junction to Lead at .50"(12.7mm) lead lengths, with both leads attached to heat sinks.

RATINGS AND CHARACTERISTIC CURVES GI750 THRU GI758

FIG. 1 — MAXIMUM FORWARD CURRENT DERATING CURRENT

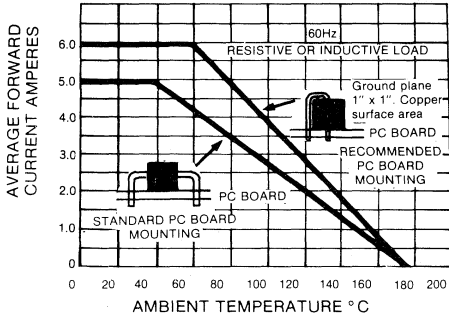

FIG. 2 — MAXIMUM FORWARD CURRENT DERATING CURVE

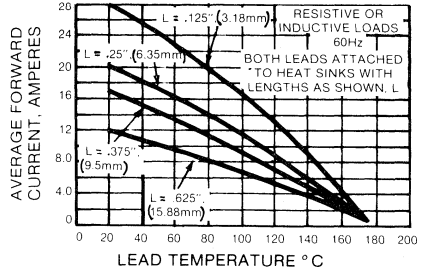

FIG. 3 — TYPICAL FORWARD CHARACTERISTICS

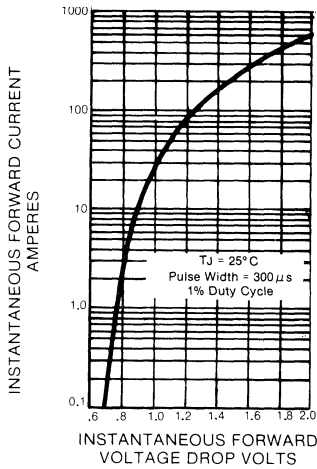

FIG. 4 — TYPICAL REVERSE CHARACTERISTICS

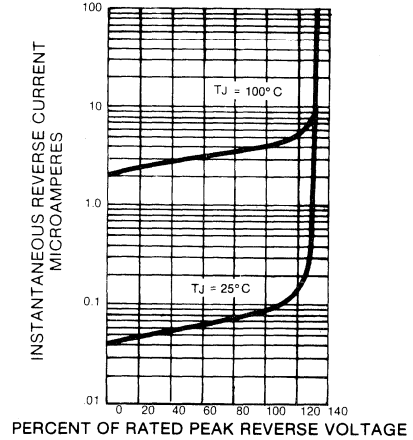

FIG. 5 — MAXIMUM PEAK FORWARD SURGE CURRENT

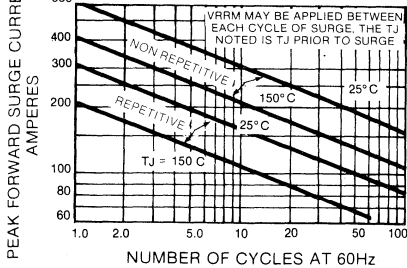
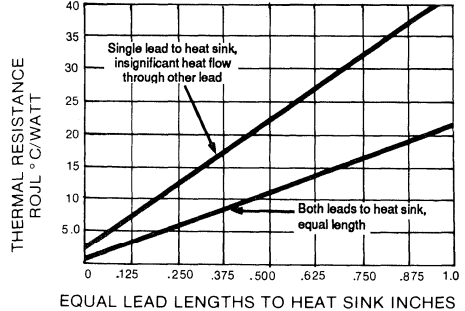

FIG. 6 — TYPICAL STEADY STATE THERMAL RESISTANCE



P600A THRU P600M

HIGH CURRENT PLASTIC SILICON RECTIFIER
VOLTAGE - 50 to 1000 Volts CURRENT - 6.0 Amperes

FEATURES

- ◆ The plastic package carries Underwriters Laboratory Flammability Classification 94V-O
- ◆ High Current Capability
- ◆ Diffused Junction
- ◆ Completely Insulated Case
- ◆ Uniform Molded Body
- ◆ High Surge Capability
- ◆ High temperature soldering guaranteed:
265°C/10 seconds/.375" (9.5mm) lead lengths at 5 lbs., (2.3kg) tension

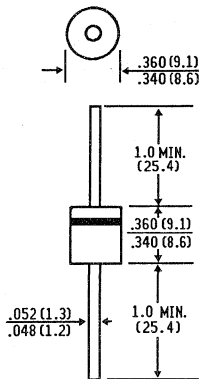

Dimensions in inches
and
(millimeters)

MECHANICAL DATA

Case: Molded plastic

Terminals: Plated Axial leads, solderable per MIL-STD-202, Method 208

Polarity: Band denotes cathode

Weight: 0.07 ounce, 2.1 gram

Mounting Position: Any

MAXIMUM RATINGS AND ELECTRICAL CHARACTERISTICS

Ratings at 25°C ambient temperature unless otherwise specified
Single phase, half wave, 60 Hz, resistive or inductive load.

	SYMBOLS	P600A	P600B	P600D	P600G	P600J	P600K	P600M	UNITS
Maximum Recurrent Peak Reverse Voltage	V _{RRM}	50	100	200	400	600	800	1000	Volts
Maximum RMS Voltage	V _{RMS}	35	70	140	280	420	560	700	Volts
Maximum DC Blocking Voltage	V _{DC}	50	100	200	400	600	800	1000	Volts
Maximum Average Forward Rectified Current .375" T _A = 60°C .375" (9.5mm) Lead Lengths (Fig 1) T _L = 60°C .375" (9.5mm) Lead Lengths (Fig 2)	I _(AV)	6.0 22.0							Amps
Peak Forward Surge Current 8.3ms single half sine-wave superimposed on rated load (JEDEC Method)	I _{FSM}	400							Amps
Maximum Instantaneous Forward Voltage at 6.0A 100A	V _F	0.90 1.30				1.0 1.4			Volts
Maximum DC Reverse Current at Rated DC Blocking Voltage T _A = 25°C T _A = 100°C	I _R	5.0 1.0							μA mA
Typical Thermal Resistance (Note 1)	θ _{JL}	10.0							°C/W
Operating and Storage Temperature Range	T _J , T _{STG}	-50 to +175							°C

NOTES:

1. Thermal Resistance from Junction to Lead at .50" (12.7mm) lead lengths, with both leads attached to heat sinks.

RATINGS AND CHARACTERISTIC CURVES P600A THRU P600M

FIG. 1 — OUTPUT CURRENT VS AMBIENT TEMPERATURE

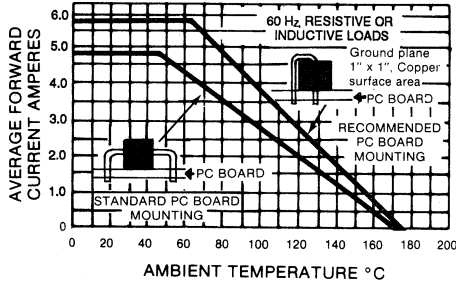

FIG. 3 — TYPICAL FORWARD CHARACTERISTIC

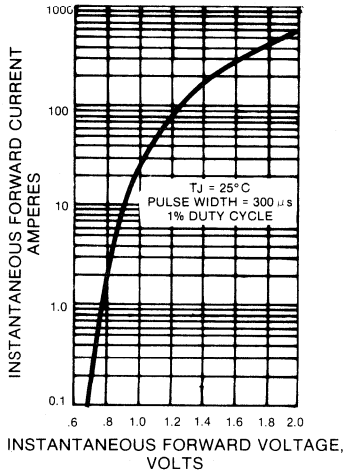

FIG. 5 — MAXIMUM NON-REPETITIVE PEAK FORWARD SURGE CURRENT

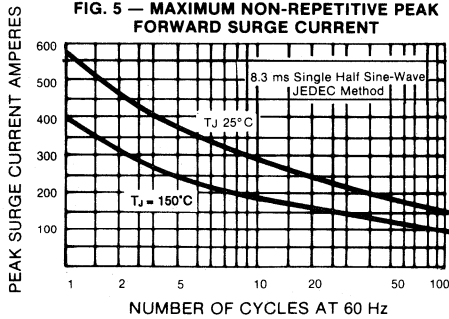

FIG. 2 — OUTPUT CURRENT VS LEAD TEMPERATURE

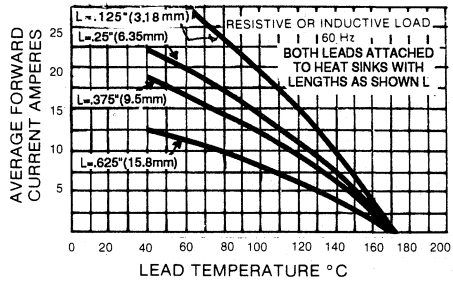

FIG. 4 — TYPICAL REVERSE CHARACTERISTICS

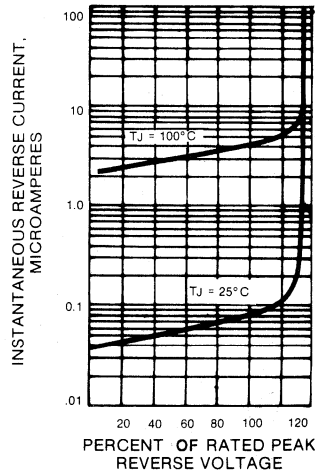
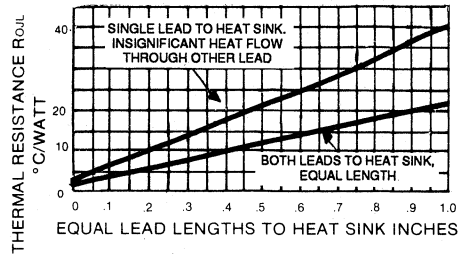

FIG. 6 — TYPICAL THERMAL RESISTANCE VS LEAD LENGTH



PLASTIC RECTIFIERS

***8.0 AMPERE TO 30 AMPERES
50 VOLTS TO 1000 VOLTS***

**GENERAL
INSTRUMENT**

NSF8AT THRU NSF8MT

ALL PURPOSE GLASS PASSIVATED RECTIFIER
VOLTAGE - 50 to 1000 Volts CURRENT - 8.0 Amperes

FEATURES

- ◆ Isolated Overmolded Package
- ◆ The plastic package carries Underwriters Laboratory Flammability Classification 94V-O
- ◆ High surge capability
- ◆ High current capability
- ◆ Low forward voltage
- ◆ Glass passivated junction
- ◆ Internal Insulation: 1.5k V_{RMS}

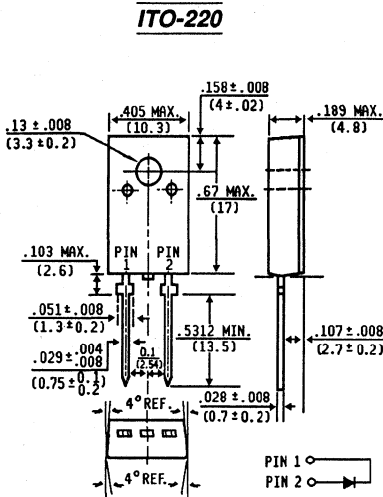
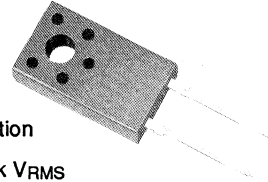

Dimensions in inches
and
(millimeters)

MECHANICAL DATA

Case: ITO-220 fully overmolded plastic

Terminals: Lead solderable per MIL-STD-202, Method 208

Polarity: As marked

Weight: .08 ounces, 2.24 grams

Mounting Position: Any

Mounting Torque: 5 in. - lbs. max.

MAXIMUM RATINGS AND ELECTRICAL CHARACTERISTICS

Ratings at 25°C ambient temperature unless otherwise specified.
Resistive or inductive load.
For capacitive load, derate current by 20%.

	SYMBOLS	NSF8 AT	NSF8 BT	NSF8 DT	NSF8 GT	NSF8 JT	NSF8 KT	NSF8 MT	UNITS
Maximum Recurrent Peak Reverse Voltage	V _{RRM}	50	100	200	400	600	800	1000	Volts
Maximum RMS Voltage	V _{RMS}	35	70	140	280	420	560	700	Volts
Maximum DC Blocking Voltage	V _{DC}	50	100	200	400	600	800	1000	Volts
Maximum Average Forward Rectified Current at T _C = 100°C	I <sub(av)< sub=""></sub(av)<>	8.0							Amps
Peak Forward Surge Current 8.3ms single half sine-wave superimposed on rated load (JEDEC Method)	I _{FSM}	175							Amps
Maximum Instantaneous Forward Voltage at 8.0A	V _F	1.1							Volts
Maximum Average Reverse Current at Peak Reverse Voltage T _C = 100°C T _C = 25°C	I _{R(AV)}	100							μA
Typical Junction Capacitance (Note 2)	C _J	55							pf
Typical Thermal Resistance (Note 1)	R _{θJC}	3.0							°C/W
Operating and Storage Temperature Range,	T _C , T _{STG}	-65 to +150							°C

NOTES:

1. Thermal Resistance Junction to Case.
2. Measured at 1.0 MHz and applied reverse voltage of 4.0 volts.

RATING AND CHARACTERISTIC CURVES NSF8AT THRU NSF8MT

Fig. 1 — FORWARD CURRENT DERATING CURVE

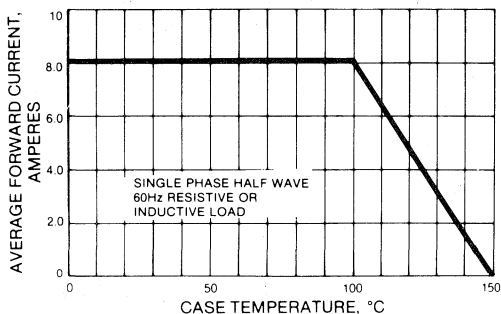

Fig. 2 — TYPICAL INSTANTANEOUS FORWARD CHARACTERISTICS

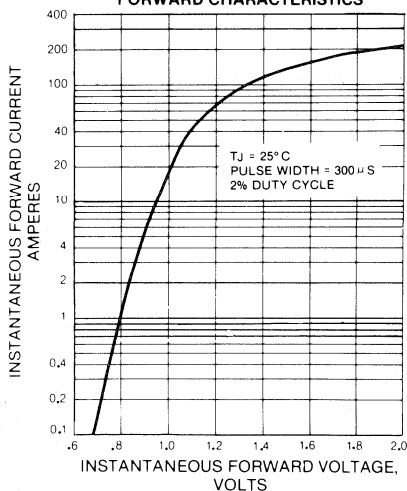

FIG. 3 - MAXIMUM NON-REPETITIVE PEAK FORWARD SURGE CURRENT

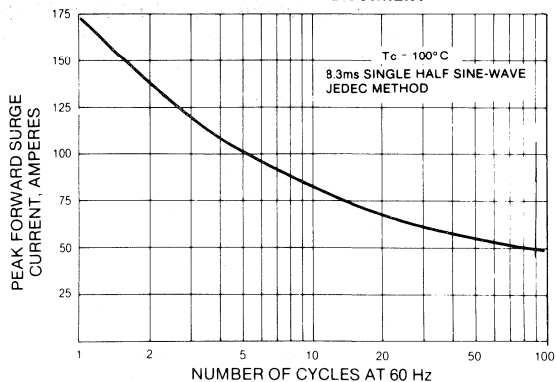

Fig. 4 — TYPICAL REVERSE CHARACTERISTICS

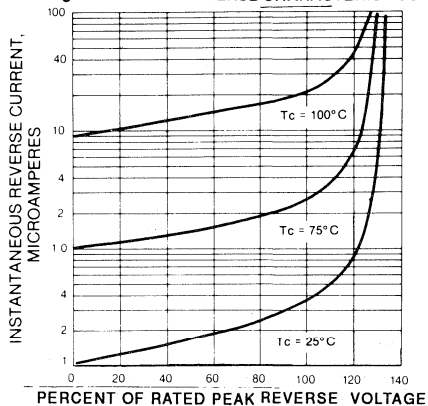
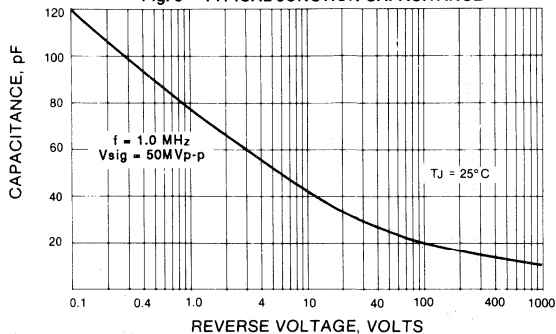

Fig. 5 — TYPICAL JUNCTION CAPACITANCE



NS8AT THRU NS8MT

HIGH CURRENT PLASTIC SILICON RECTIFIER
VOLTAGE - 50 to 1000 Volts CURRENT - 8.0 Amperes

FEATURES

- ◆ The plastic package carries Underwriters Laboratory Flammability Classification 94V-0
- ◆ High current capability
- ◆ High surge capability
- ◆ Low forward voltage
- ◆ Glass passivated chip junction
- ◆ High temperature soldering guaranteed: 265°C/10 seconds/.375", (9.5mm) lead lengths at 5 lbs., (2.3kg) tension

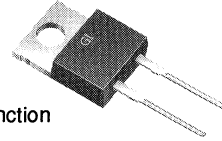

TO-220

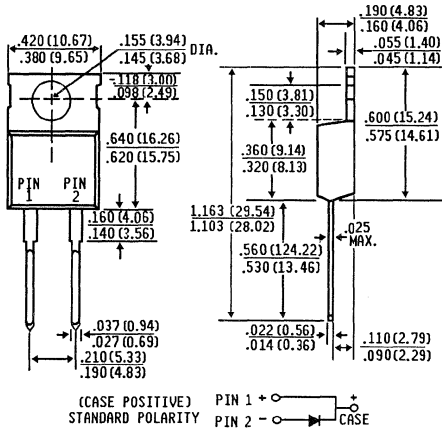

Dimensions in inches and (millimeters)

MECHANICAL DATA

Case: TO-220 molded plastic

Terminals: Lead solderable per MIL-STD-202, Method D08

Polarity: As marked

Weight: 0.08 ounce, 2.24 gram

Mounting Position: Any

MAXIMUM RATINGS AND ELECTRICAL CHARACTERISTICS

Ratings at 25°C ambient temperature unless otherwise specified.
 Single phase, half wave, 60 Hz, resistive or inductive load.
 For capacitive load, derate current by 20%.

	SYMBOLS	NS8 AT	NS8 BT	NS8 DT	NS8 GT	NS8 JT	NS8 KT	NS8 MT	UNITS
Maximum Recurrent Peak Reverse Voltage	V _{RRM}	50	100	200	400	600	800	1000	Volts
Maximum RMS Voltage	V _{RMS}	35	70	140	280	420	560	700	Volts
Maximum DC Blocking Voltage	V _{DC}	50	100	200	400	600	800	1000	Volts
Maximum Average Forward Rectified Current T _C = 100°C	I _(AV)	8.0							Amps
Peak Forward Surge Current 8.3ms single half sine-wave superimposed on rated load (JEDEC Method)	I _{FSM}	175							Amps
Maximum Instantaneous Forward Voltage at 8.0A	V _F	1.1							Volts
Maximum Reverse Current at Rated DC Blocking Voltage T _C = 25°C T _C = 100 °C	I _R	10.0 100							μA
Typical Junction Capacitance (Note 2) T _J = 25°C	C _J	55.0							pf
Typical Thermal Resistance (Note 1)	R _{θJC}	3.0							°C/W
Operating and Storage Temperature Range	T _J , T _{STG}	-50 to +150							°C

NOTES:

1. Thermal Resistance from Junction to Case.
2. Measured at 1 MHz and applied reversed voltage of 4.0 volts.

RATINGS AND CHARACTERISTIC CURVES NS8AT THRU NS8MT

Fig. 1— FORWARD CURRENT DERATING CURVE

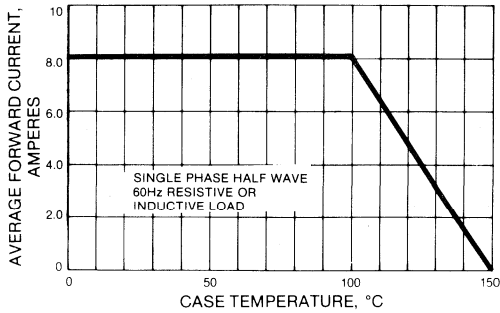

Fig. 2— TYPICAL INSTANTANEOUS FORWARD CHARACTERISTICS

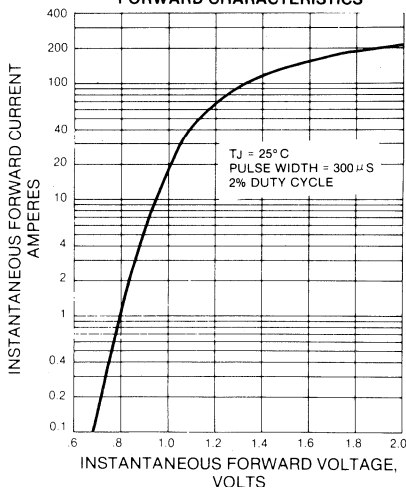

FIG. 3 - MAXIMUM NON-REPETITIVE PEAK FORWARD SURGE CURRENT

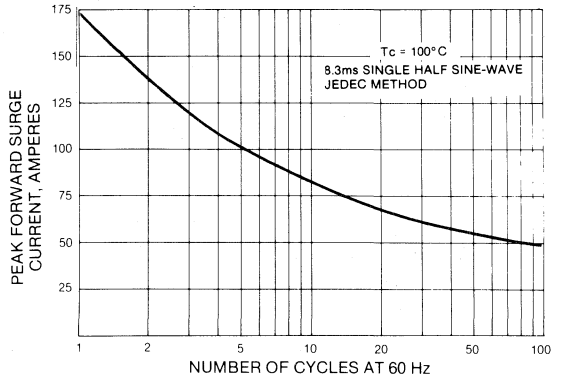

Fig. 4— TYPICAL REVERSE CHARACTERISTICS

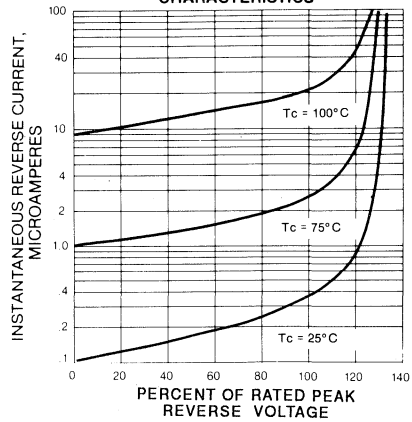
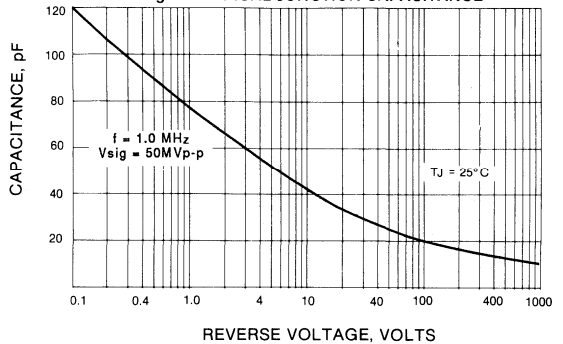

Fig. 5— TYPICAL JUNCTION CAPACITANCE



NPF16AT THRU NPF16MT

ALL PURPOSE GLASS PASSIVATED RECTIFIER
VOLTAGE - 50 to 1000 Volts CURRENT - 16.0 Ampere

FEATURES

- ◆ Isolated Overmolded package
- ◆ The plastic package carries Underwriters Laboratory Flammability Classification 94V-0
- ◆ Dual rectifier construction
- ◆ Dual glass passivated chip junctions
- ◆ High surge capability
- ◆ Low forward voltage
- ◆ High current capability
- ◆ Internal Insulation: 1.5k VRMS

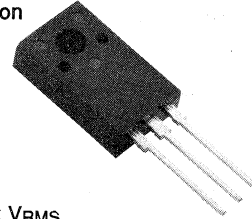

ITO-220 CT

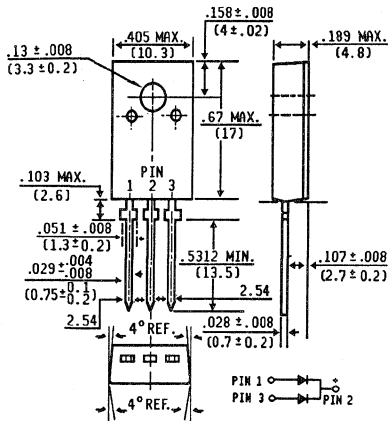

Dimensions in inches
and
(millimeters)

MECHANICAL DATA

Case: ITO-220 Fully overmolded plastic

Terminals: Lead solderable per MIL-STD-202, Method 208

Polarity: As marked

Weight: 0.08 ounce, 2.24 gram

Mounting Position: Any

Mounting Torque: 5 in. - lbs. max.

MAXIMUM RATINGS AND ELECTRICAL CHARACTERISTICS

Ratings at 25°C ambient temperature unless otherwise specified
 Single phase, half wave, 60 Hz, resistive or inductive load.
 For capacitive load, derate current by 20%.

		NPF16 AT	NPF16 BT	NPF16 DT	NPF16 GT	NPF16 JT	NPF16 KT	NPF16 MT	UNITS
Maximum Recurrent Peak Reverse Voltage	V _{RRM}	50	100	200	400	600	800	1000	Volts
Maximum RMS Voltage	V _{RMS}	35	70	140	280	420	560	700	Volts
Maximum DC Blocking Voltage	V _{DC}	50	100	200	400	600	800	1000	Volts
Maximum Average Forward Rectified Current at T _C = 100°C	I <sub(av)< sub=""></sub(av)<>	16.0							Amps
Peak Forward Surge Current 8.3ms single half sine-wave superimposed on rated load (JEDEC Method) per leg	I _{FSM}	175							Amps
Maximum Instantaneous Forward Voltage at 8A per leg	V _F	1.1							Volts
Maximum Reverse Current at Rated DC Blocking Voltage T _C = 25°C Per leg T _C = 100°C	I _R	10.0 100							μA
Typical Junction Capacitance (Note 2) T _J = 25°C	C _J	55.0							pf
Typical Thermal Resistance (Note 1)	R _{θJC}	3.0							°C/W
Operating and Storage Temperature Range	T _C , T _{STG}	-65 to +150							°C

NOTES:

1. Thermal Resistance from Junction to Case.
2. Measured at 1 MHz and applied reverse voltage of 4.0 volts.

RATING AND CHARACTERISTIC CURVES NPF16AT THRU NPF16MT

Fig. 1— FORWARD CURRENT DERATING CURVE

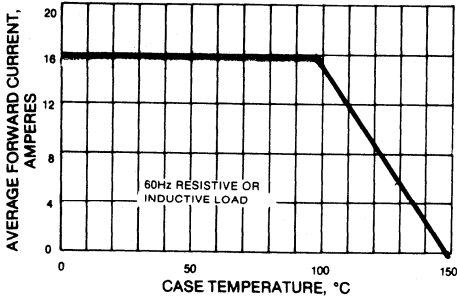

Fig. 2— TYPICAL INSTANTANEOUS FORWARD CHARACTERISTICS PER LEG

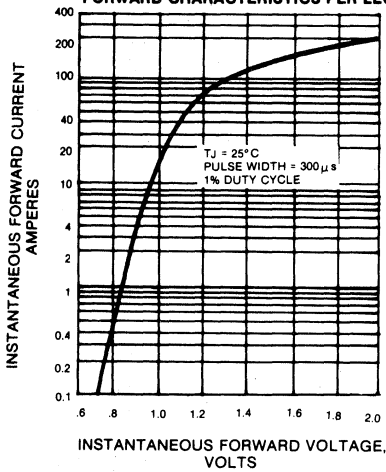

Fig. 3— MAXIMUM NON-REPETITIVE SURGE CURRENT

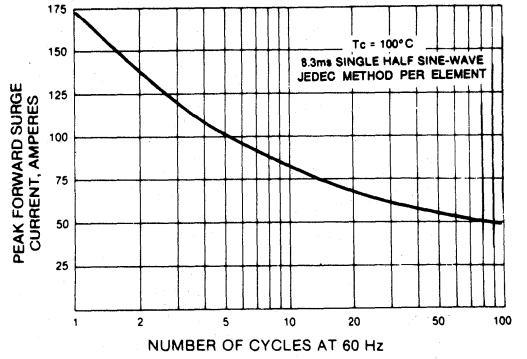

FIG. 4— TYPICAL REVERSE CHARACTERISTICS PER LEG

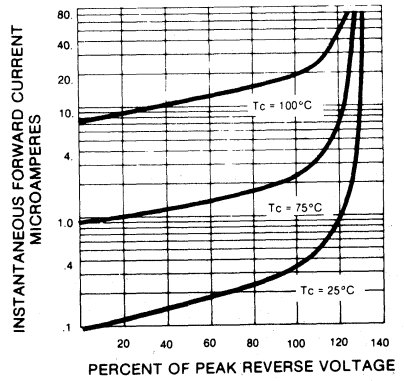
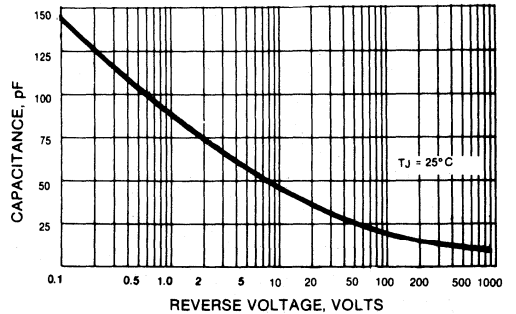

FIG. 5— TYPICAL JUNCTION CAPACITANCE



NP16AT THRU NP16MT

HIGH CURRENT PLASTIC SILICON RECTIFIER
VOLTAGE - 50 to 1000 Volts CURRENT - 16.0 Ampere

FEATURES

- ◆ The plastic package carries Underwriters Laboratory Flammability Classification 94V-0
- ◆ Dual rectifier construction, positive center-tap
- ◆ Dual glass passivated chip junctions
- ◆ High surge capability
- ◆ Low forward voltage
- ◆ High temperature soldering guaranteed: 265°C/10 seconds/.375", (9.5mm) lead lengths at 5 lbs., (2.3kg) tension

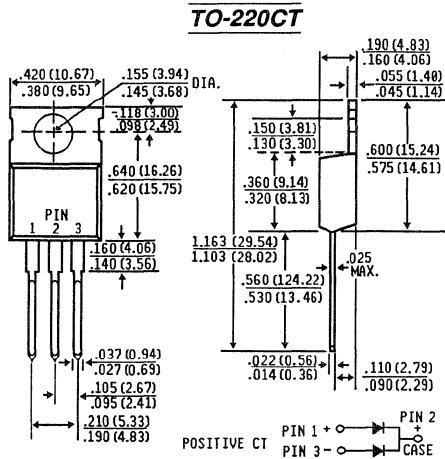
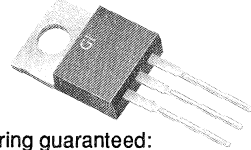

Dimensions in inches and (millimeters)

MECHANICAL DATA

Case: TO-220CT molded plastic

Terminals: Lead solderable per MIL-STD-202, Method 208

Polarity: As marked

Weight: 0.08 ounce, 2.24 gram

Mounting Position: Any

MAXIMUM RATINGS AND ELECTRICAL CHARACTERISTICS

Ratings at 25°C ambient temperature unless otherwise specified
 Single phase, half wave, 60 Hz, resistive or inductive load.
 For capacitive load, derate current by 20%.

	SYMBOLS	NP16 AT	NP16 BT	NP16 DT	NP16 GT	NP16 JT	NP16 KT	NP16 MT	UNITS	
Maximum Recurrent Peak Reverse Voltage	V _{RRM}	50	100	200	400	600	800	1000	Volts	
Maximum RMS Voltage	V _{RMS}	35	70	140	280	420	560	700	Volts	
Maximum DC Blocking Voltage	V _{DC}	50	100	200	400	600	800	1000	Volts	
Maximum Average Forward Rectified Current at T _c = 100°C per Device	I _(AV)								16.0	Amps
Peak Forward Surge Current 8.3ms single sine-wave superimposed on rated load (JEDEC Method)	I _{FSM}								300.0	Amps
Maximum Instantaneous Forward Voltage at 8A per leg	V _F								1.1	Volts
Maximum Reverse Current at Rated DC Blocking Voltage T _c = 25°C Per leg T _c = 100°C	I _R								10.0 100	μA
Typical Junction Capacitance (Note 2)	C _J								55.0	pf
Typical Thermal Resistance per leg (Note 1)	R _{θJC}								3.0	°C/W
Operating and Storage Temperature Range	T _c , T _{STG}								-55 to +150	°C

NOTES:

1. Thermal Resistance from Junction to Case for each element.
2. Measured at 1 MHz and applied reverse voltage of 4.0 volts for each element.

RATINGS AND CHARACTERISTIC CURVES NP16AT THRU NP16MT

Fig. 1— FORWARD CURRENT DERATING CURVE

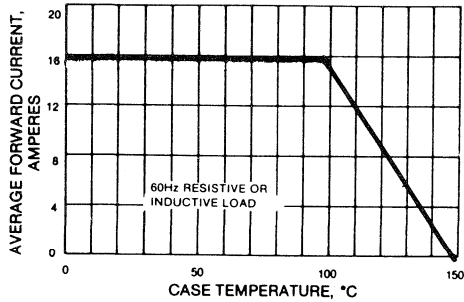

Fig. 2— TYPICAL INSTANTANEOUS FORWARD CHARACTERISTICS PER LEG

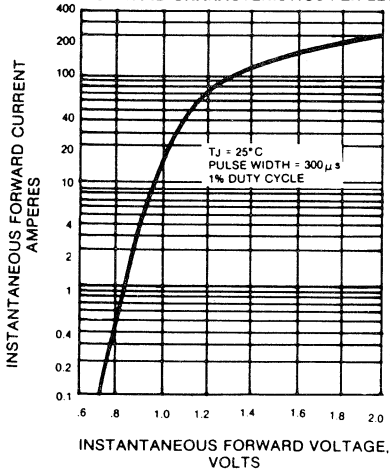

Fig. 3— MAXIMUM NON-REPETITIVE SURGE CURRENT

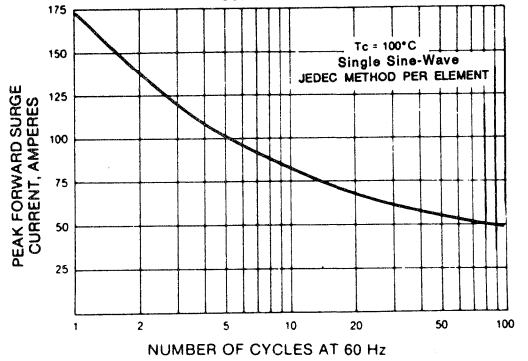

FIG. 4— TYPICAL REVERSE CHARACTERISTICS PER LEG

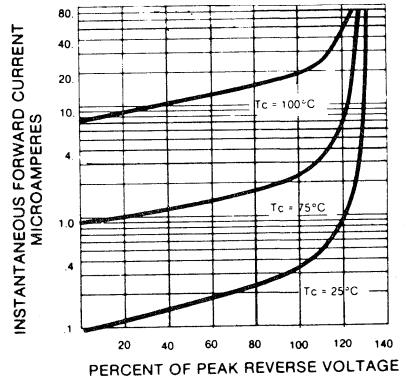
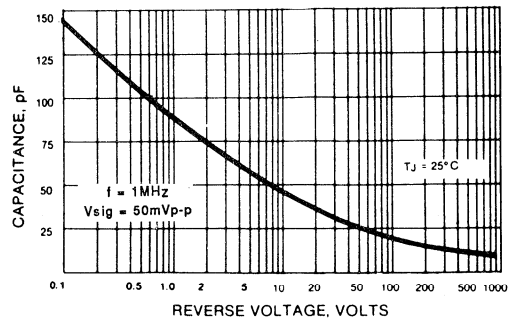

FIG. 5— TYPICAL JUNCTION CAPACITANCE



ARS25 / AR25 SERIES

HIGH CURRENT PLASTIC SILICON RECTIFIER
VOLTAGE - 50 to 1000 Volts CURRENT - 25.0 Amperes

FEATURES

- ◆ The plastic package carries Underwriters Laboratory Flammability Classification 94V-O
- ◆ Low cost construction utilizing void-free molded plastic technique
- ◆ Low cost
- ◆ Diffused junction
- ◆ Low leakage
- ◆ High surge capability
- ◆ High temperature soldering guaranteed: 250°C for 10 seconds

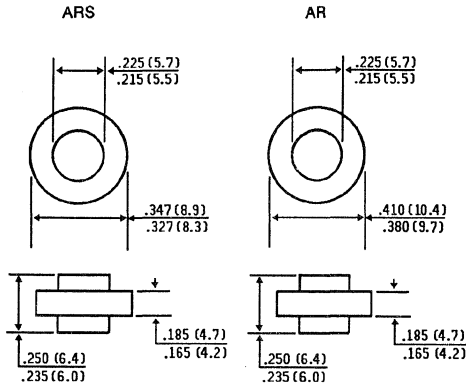

Dimensions in inches and (millimeters)

MECHANICAL DATA

Case: Transfer, molded plastic case

Terminals: Plated terminals, solderable per MIL-STD-202, Method 208

Polarity: Color Ring denotes cathode end

Weight: 0.07 ounce, 1.8 gram

Mounting Position: Any

MAXIMUM RATINGS AND ELECTRICAL CHARACTERISTICS

Ratings at 25°C ambient temperature unless otherwise specified
 Single phase, half wave, 60 Hz, resistive or inductive load.
 For capacitive load, derate current by 20%.

	SYMBOLS	ARS25A	ARS25B	ARS25D	ARS25G	ARS25J	ARS25K	ARS25M	UNITS
		ARS25A	ARS25B	ARS25D	ARS25G	ARS25J	ARS25K	ARS25M	
Maximum Recurrent Peak Reverse Voltage	V _{RRM}	50	100	200	400	600	800	1000	Volts
Maximum RMS Voltage	V _{RMS}	35	70	140	280	420	560	700	Volts
Maximum DC Blocking Voltage	V _{DC}	50	100	200	400	600	800	1000	Volts
Maximum Average Forward Rectified Current .375", (4.5mm) lead lengths at T _C = 150°C	I _(AV)	25.0							Amps
Peak Forward Surge Current 8.3ms single half sine-wave superimposed on rated load (JEDEC Method) at T _J = 150°C	I _{FSM}	400							Amps
Maximum Instantaneous Forward Voltage at 25.0A	V _F	1.0							Volts
Maximum DC Reverse Current T _C = 25°C at Rated DC Blocking Voltage T _C = 100°C	I _R	5.0 250							μA
Typical Reverse Recovery Time (Note 2)	T _{RR}	3.0							μs
Typical Junction Capacitance (Note 1) T _J = 25°C	C _J	300							pf
Typical Thermal Resistance (Note 3)	R _{θJC}	1.0							°C/W
Operating and Storage Temperature Range,	T _J , T _{STG}	-50 to +175							°C
Polarity and Voltage Denotation Color Band		Red	Yellow	Silver	Orange	Green	Blue	Violet	

NOTES:

1. Measured at 1.0 MHz and applied reverse voltage of 4.0 V_{DC}.
2. Reverse Recovery Test Conditions : I_F = 0.5A, I_R = 1.0A, I_{rr} = .25A.
3. Thermal Resistance from Junction to Case, single side cooled.

RATINGS AND CHARACTERISTIC CURVES ARS25 / AR25 SERIES

FIG. 1 — MAXIMUM FORWARD CURRENT DERATING CURVE

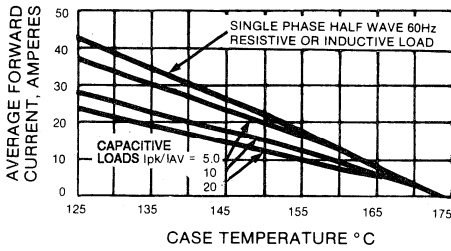

FIG. 3 — TYPICAL INSTANTANEOUS FORWARD CHARACTERISTICS

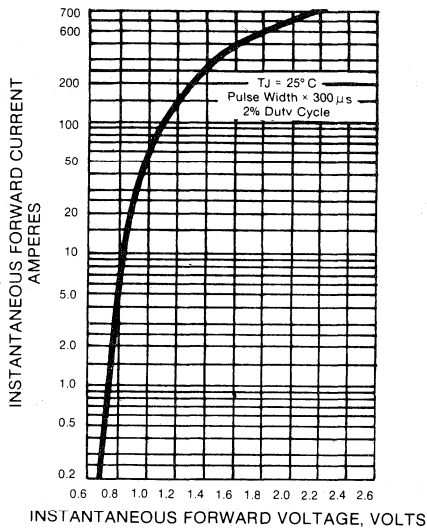

FIG. 2 — MAXIMUM NON-REPETITIVE PEAK FORWARD SURGE CURRENT

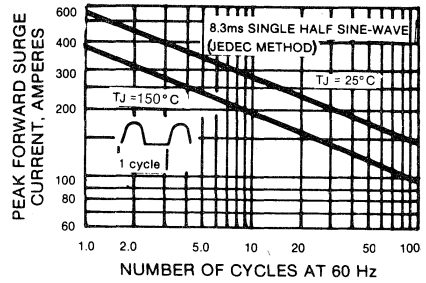

FIG. 4 — TYPICAL REVERSE CHARACTERISTICS

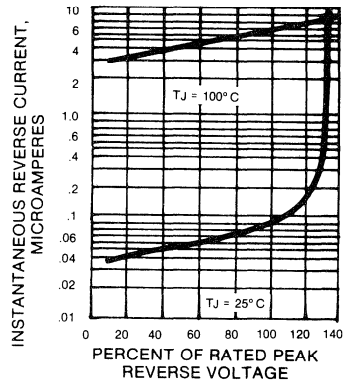
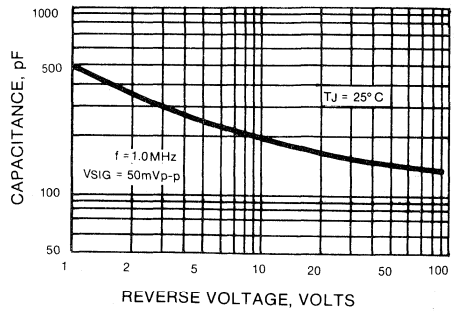

FIG. 5 — TYPICAL JUNCTION CAPACITANCE



**FAST RECOVERY
PLASTIC RECTIFIERS**

***1.0 AMPERE TO 8.0 AMPERES
50 VOLTS TO 1000 VOLTS***

**GENERAL
INSTRUMENT**

1N4933 THRU 1N4937

MINIATURE PLASTIC FAST SWITCHING RECTIFIER
VOLTAGE - 50 to 600 Volts CURRENT - 1.0 Ampere

FEATURES

- ◆ Low cost
- ◆ The plastic package carries Underwriters Laboratory Flammability Classification 94V-0
- ◆ Fast switching for high efficiency
- ◆ Void-free plastic molded case
- ◆ 1.0 Ampere operation at $T_A = 75^\circ\text{C}$ with no thermal runaway
- ◆ High temperature soldering guaranteed: $265^\circ\text{C}/10$ seconds/.375", (9.5mm) lead lengths at 5 lbs., (2.3kg) tension

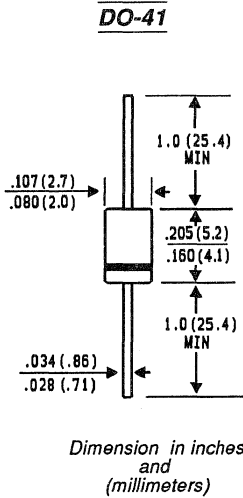

MECHANICAL DATA

Case: JEDEC DO-41, molded case

Terminals: Plated Axial leads, solderable per MIL-STD-202, Method 208

Polarity: Color band denotes cathode

Mounting Position: Any

Weight: 0.012 ounce, 0.34 gram

MAXIMUM RATINGS AND ELECTRICAL CHARACTERISTICS

Ratings at 25°C ambient temperature unless otherwise specified.
 Resistive or inductive load. For capacitive load, derate current by 20%.

	SYMBOLS	1N4933	1N4934	1N4935	1N4936	1N4937	UNITS
*Maximum Recurrent Peak Reverse Voltage	V_{RRM}	50	100	200	400	600	Volts
*Maximum RMS Voltage	V_{RMS}	35	70	145	280	420	Volts
*Maximum DC Blocking Voltage	V_{DC}	50	100	200	400	600	Volts
*Maximum Average Forward Rectified Current .375", (9.5mm) lead lengths at $T_A = 75^\circ\text{C}$	$I_{(AV)}$	1.0					Amps
*Peak Forward Surge Current 8.3ms single half sine-wave superimposed on rated load (JEDEC Method) at $T_A = 75^\circ\text{C}$	I_{FSM}	30.0					Amps
*Maximum Instantaneous Forward Voltage at 1.0A	V_F	1.2					Volts
*Maximum DC Reverse Current $T_A = 25^\circ\text{C}$ at Rated DC Blocking Voltage $T_A = 100^\circ\text{C}$	I_R	5.0 100					μA
*Maximum Reverse Recovery Time (Note 1) $T_J = 25^\circ\text{C}$	T_{RR}	200					nS
*Maximum Reverse Recovery Current (Note 1)	$I_{RM(Rec)}$	2.0					Amps
Typical Junction Capacitance (Note 2)	C_J	15.0					pf
Typical Thermal Resistance (Note 3)	$R_{\theta JA}$	41.0					$^\circ\text{C/W}$
*Operating and Storage Temperature Range,	T_J, T_{STG}	-50 to +150					$^\circ\text{C}$

NOTES:

1. Reverse Recovery Test Conditions: $I_F = 1.0\text{A}$, $V_R = 30\text{V}$, $di/dt = 50\text{A}/\mu\text{s}$.
 2. Measured at 1.0 MHz and applied reverse voltage of 4.0 V_{DC}.
 3. Thermal Resistance from Junction to Ambient at .375" (9.5mm) lead lengths, P.C. Board mounted.
- *JEDEC registered values

RATINGS AND CHARACTERISTIC CURVES 1N4933 THRU 1N4937

FIG. 1 — FORWARD CURRENT DERATING CURVE

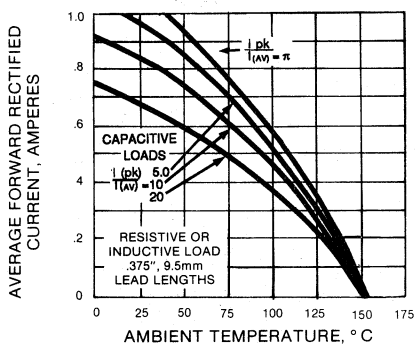

FIG. 2 — MAXIMUM NON-REPETITIVE PEAK FORWARD SURGE CURRENT

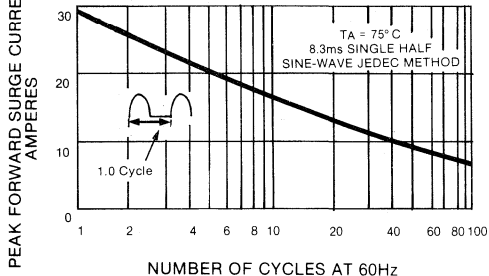

FIG. 3 — TYPICAL JUNCTION CAPACITANCE

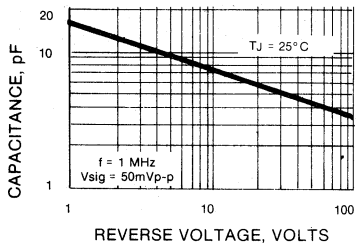

FIG. 4 — TYPICAL INSTANTANEOUS FORWARD CHARACTERISTICS

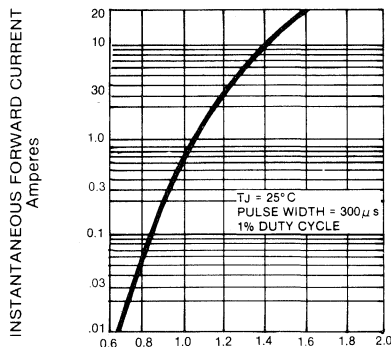

FIG. 5 — REVERSE RECOVERY TIME CHARACTERISTIC AND TEST CIRCUIT DIAGRAM

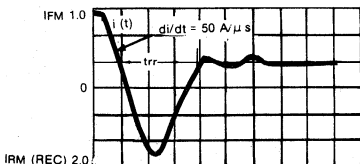
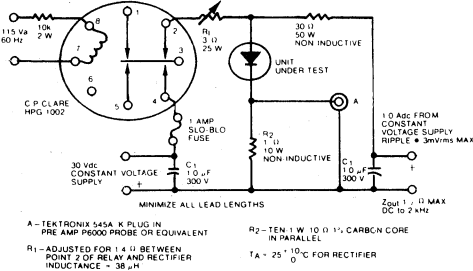
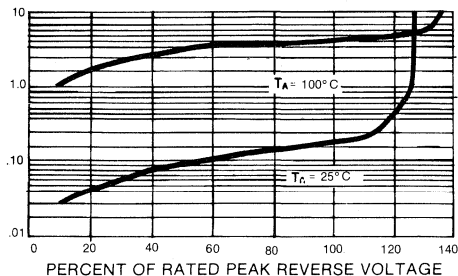

FIG. 5 — TYPICAL REVERSE CHARACTERISTICS



SRP100A THRU SRP100K

SOFT RECOVERY FAST SWITCHING PLASTIC RECTIFIER
VOLTAGE - 50 to 800 Volts CURRENT - 1.0 Ampere

FEATURES

- ◆ High surge current capability
- ◆ The plastic package carries Underwriters Laboratory Flammability Classification 94V-O
- ◆ Void-free plastic in DO-41 package
- ◆ 1.0 Ampere operation at $T_A = 55^\circ\text{C}$ with no thermal runaway
- ◆ Fast switching for high efficiency
- ◆ High temperature soldering guaranteed: $265^\circ\text{C}/10$ seconds/.375" (9.5mm) lead lengths at 5 lbs., (2.3kg) tension

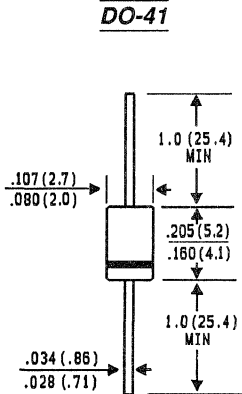

*Dimension in inches
and
(millimeters)*

MECHANICAL DATA

Case: JEDEC DO-41 molded plastic

Terminals: Plated Axial leads, solderable per MIL-ST-202, Method 208

Polarity: Band denotes cathode

Mounting Position: Any

Weight: 0.012 ounce, 0.34 gram

MAXIMUM RATINGS AND ELECTRICAL CHARACTERISTICS

Ratings at 25°C ambient temperature unless otherwise specified.
 Resistive or inductive load. For capacitive load, derate current by 20%.

	SYMBOLS	SRP 100A	SRP 100B	SRP 100D	SRP 100G	SRP 100J	SRP 100K	UNITS
Maximum Recurrent Peak Reverse Voltage	V_{RRM}	50	100	200	400	600	800	Volts
Maximum RMS Voltage	V_{RMS}	35	70	140	280	420	560	Volts
Maximum DC Blocking Voltage	V_{DC}	50	100	200	400	600	800	Volts
Maximum Average Forward Rectified Current .375", (9.5mm) lead lengths at $T_A = 55^\circ\text{C}$	$I_{(AV)}$	1.0						Amps
Peak Forward Surge Current 8.3ms single half sine-wave superimposed on rated load (JEDEC Method)	I_{FSM}	30.0						Amps
Maximum Instantaneous Forward Voltage at 1.0A	V_F	1.3						Volts
Maximum DC Reverse Current $T_A = 25^\circ\text{C}$ at Rated DC Blocking Voltage $T_A = 100^\circ\text{C}$	I_R	10.0 200						μA
Maximum Reverse Recovery Time (Note 2) $T_J = 25^\circ\text{C}$	T_{RR}	100				200		ns
Typical Junction Capacitance (Note 1) $T_J = 25^\circ\text{C}$	C_J	12.0						pf
Typical Thermal Resistance (Note 3)	$R_{\theta JA}$	41.0						$^\circ\text{C}/\text{W}$
Operating Temperature Range	T_J	-50 to +125						$^\circ\text{C}$
Storage Temperature Range	T_{STG}	-50 to +150						$^\circ\text{C}$

NOTES:

1. Measured at 1 MHz and applied reverse voltage of 4.0 volts.
2. Reverse Recovery Test Conditions: $I_F = 0.5\text{A}$, $I_R = 1.0\text{A}$, $I_{rr} = .25\text{A}$.
3. Thermal Resistance from Junction to Ambient at .375" (9.5mm) lead lengths, P.C. Board mounted.

RATINGS AND CHARACTERISTIC CURVES SRP100A THRU SRP100K

FIG. 1 — FORWARD CURRENT DERATING CURVE

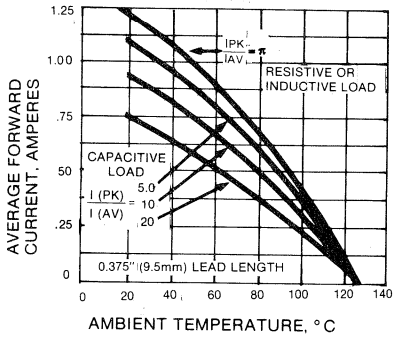

FIG. 3 — TYPICAL INSTANTANEOUS FORWARD CHARACTERISTICS

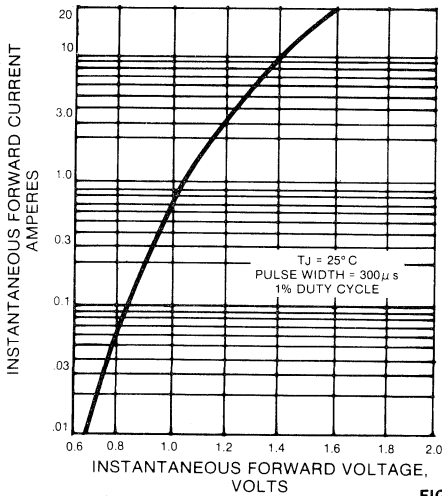

FIG. 5 — TYPICAL JUNCTION CAPACITANCE

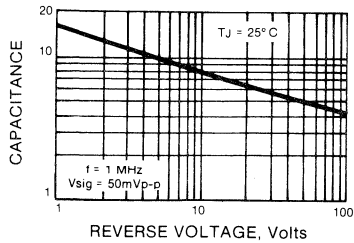

FIG. 2 — MAXIMUM NON-REPETITIVE PEAK FORWARD SURGE CURRENT

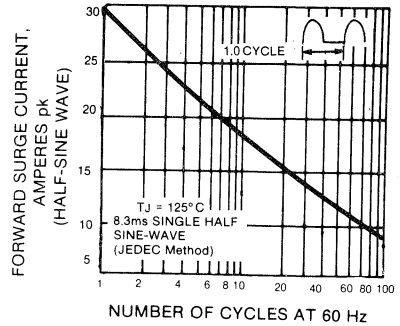

FIG. 4 — TYPICAL REVERSE CHARACTERISTICS

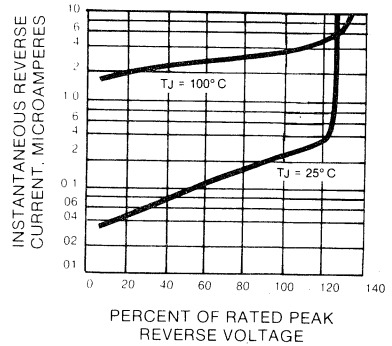
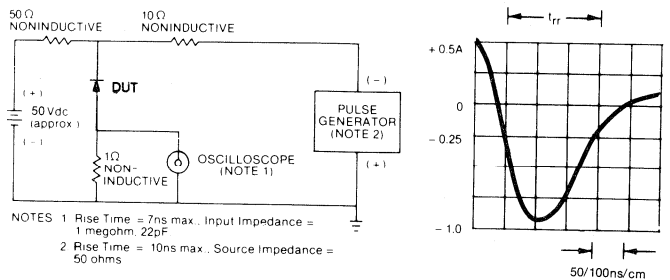

FIG. 6 — REVERSE RECOVERY TIME CHARACTERISTIC AND TEST DIAGRAM



BYX55-350P AND BYX55-600P

SOFT RECOVERY, FAST SWITCHING PLASTIC RECTIFIER

VOLTAGE - 350 to 600 Volts CURRENT - 1.2 Amperes

FEATURES

- ◆ High surge current capability
- ◆ The plastic package carries Underwriters Laboratory Flammability Classification 94V-0
- ◆ Void-free plastic package
- ◆ High surge current capability
- ◆ 1.2 Ampere at $T_A = 55^\circ\text{C}$ with no thermal runaway
- ◆ Fast switching for high efficiency
- ◆ High temperature soldering guaranteed: $265^\circ\text{C}/10$ seconds/.375", (9.5mm) lead lengths at 5 lbs., (2.3kg) tension

MECHANICAL DATA

Case: JEDEC DO-201AD molded plastic

Terminals: Axial leads, solderable per MIL-STD-202, Method 208

Polarity: Color band denotes cathode

Mounting Position: Any

Weight: .04 ounce, 1.1 gram

DO-201AD

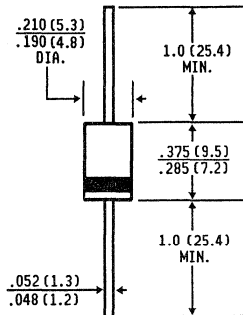

Dimensions in inches
and
(millimeters)

MAXIMUM RATINGS AND ELECTRICAL CHARACTERISTICS

Ratings at 25°C ambient temperature unless otherwise specified.
Resistive or inductive load.
For capacitive load, derate current by 20%.

	SYMBOLS	BYX55-350P	BYX55-600P	UNITS
Maximum Recurrent Peak Reverse Voltage	V_{RRM}	350	600	Volts
Maximum RMS Voltage	V_{RMS}	210	350	Volts
Maximum DC Blocking Voltage	V_{DC}	300	500	Volts
Maximum Average Forward Rectified Current .375", (4.5mm) lead lengths at $T_A = 55^\circ\text{C}$	$I_{(AV)}$	1.2		Amps
Peak Forward Surge Current 10ms single half sine-wave superimposed on rated load at $T_J = 125^\circ\text{C}$	I_{FSM}	40.0		Amps
Maximum Instantaneous Forward Voltage at 5.0A	V_F	1.25		Volts
Maximum Reverse Current $T_A = 25^\circ\text{C}$	I_R	10.0		μA
at Rated DC Blocking Voltage $T_A = 100^\circ\text{C}$	I_R	750		μA
Maximum Reverse Recovery Time (Note 2) $T_A = 25^\circ\text{C}$	T_{RR}	350		ns
Typical Junction Capacitance (Note 1)	C_J	28.0		pf
Typical Thermal Resistance (Note 3)	$R_{\theta JA}$	15.0		$^\circ\text{C}/\text{W}$
Operating Temperature Range	T_J	-50 to +125		$^\circ\text{C}$
Storage Temperature Range	T_{STG}	-50 to +150		$^\circ\text{C}$

NOTES:

1. Measured at 1.0 MHz and applied reverse voltage of 4.0 volts.
2. Reverse Recovery TEST Conditions: $I_F = 1.0\text{A}$, $V_R = 30\text{V}$, $dI/dt = 20\text{ A}/\mu\text{s}$.
3. Thermal Resistance from Junction to Ambient at .375" (9.5mm) lead lengths with both leads to heat sink.

RATINGS AND CHARACTERISTIC CURVES BYX55-350P AND BYX55-600P

FIG. 1 — FORWARD CURRENT DERATING CURVE

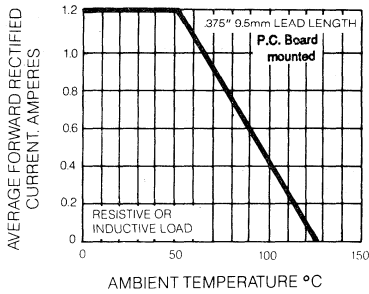

FIG. 3 — TYPICAL INSTANTANEOUS FORWARD CHARACTERISTICS

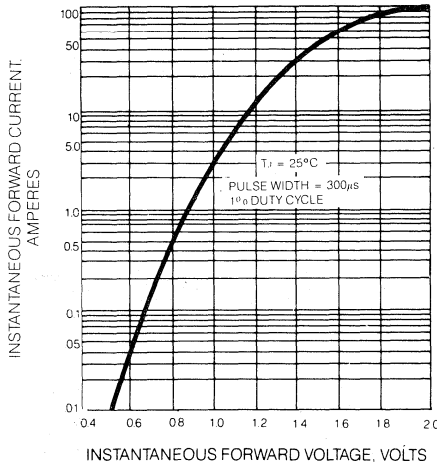

FIG. 5 — TYPICAL REVERSE CHARACTERISTICS

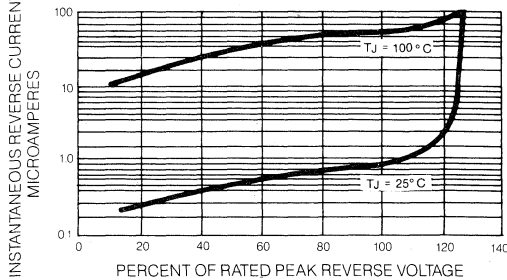

FIG. 2 — MAXIMUM NON-REPETITIVE PEAK FORWARD SURGE CURRENT

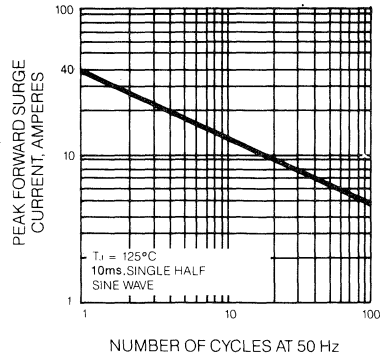

FIG. 4 — TYPICAL JUNCTION CAPACITANCE

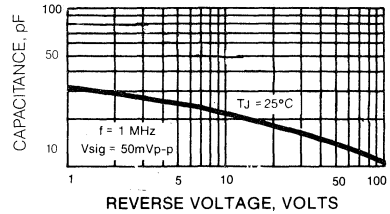
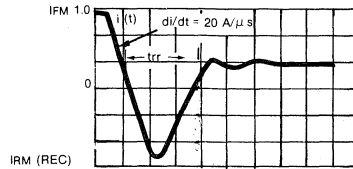
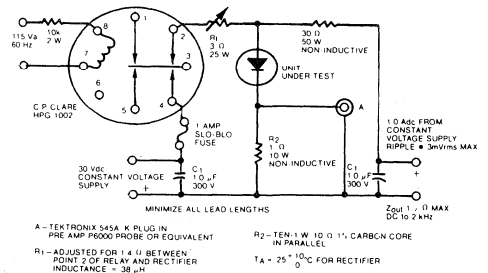

FIG. 6 — REVERSE RECOVERY TIME CHARACTERISTIC AND TEST CIRCUIT DIAGRAM



BY296P THRU BY299P

SOFT RECOVERY PLASTIC RECTIFIER
VOLTAGE - 100 to 800 Volts CURRENT - 2.0 Amperes

FEATURES

DO-201AD

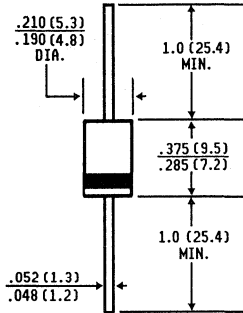

Dimensions in inches
and
(millimeters)

- ◆ High surge current capability
- ◆ The plastic package carries Underwriters Laboratory Flammability Classification 94V-O
- ◆ Void-free plastic package
- ◆ 2.0 Ampere operation at $T_A = 55^\circ\text{C}$ with no thermal runaway
- ◆ Fast switching for high efficiency
- ◆ High temperature soldering guaranteed: $265^\circ\text{C}/10$ seconds/.375"(.95mm) lead lengths at 5 lbs., (2.3kg) tension

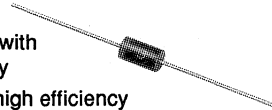

MECHANICAL DATA

- Case:** Molded plastic
Terminals: Axial leads, solderable per MIL-ST-202, Method 208
Polarity: Color band denotes cathode
Mounting Position: Any
Weight: .04 ounce, 1.1 gram

MAXIMUM RATINGS AND ELECTRICAL CHARACTERISTICS

Ratings at 25°C ambient temperature unless otherwise specified.
 Single phase, half wave, 60 Hz, resistive or inductive load.
 For capacitive load, derate current by 20%.

	SYMBOLS	BY296P	BY297P	BY298P	BY299P	UNITS
Maximum Recurrent Peak Reverse Voltage	V_{RRM}	100	200	400	800	Volts
Maximum RMS Voltage	V_{RMS}	70	140	280	560	Volts
Maximum DC Blocking Voltage	V_{DC}	100	200	400	800	Volts
Maximum Average Forward Rectified Current .375", (9.5mm) lead lengths at $T_A = 55^\circ\text{C}$	$I_{(AV)}$	2.0				Amps
Peak Forward Surge Current 10ms single half sine-wave superimposed on rated load	I_{FSM}	70.0				Amps
Maximum Repetitive Peak Forward Surge (Note 1)	I_{FRM}	10.0				Amps
Maximum Instantaneous Forward Voltage at 3.0A	V_F	1.3				Volts
Maximum DC Reverse Current at Rated DC Blocking Voltage $T_A = 25^\circ\text{C}$ $T_A = 100^\circ\text{C}$	I_R	10.0 500				μA
Maximum Reverse Recovery Time (Note 3) $T_J = 25^\circ\text{C}$	T_{RR}	500				ns
Maximum Forward Recovery Time at 100mA	T_{FR}	1.0				μs
Typical Junction Capacitance (Note 2) $T_J = 25^\circ\text{C}$	C_J	28.0				pf
Typical Thermal Resistance (Note 4)	$R_{\theta JA}$	15.0				$^\circ\text{C/W}$
Operating Temperature Range	T_J	-50 to +125				$^\circ\text{C}$
Storage Temperature Range	T_{STG}	-50 to +150				$^\circ\text{C}$

NOTES:

1. Repetitive Peak Forward Surge Current at $f < 15\text{KHz}$
2. Measured at 1 MHz and applied reverse voltage of 4.0 volts.
3. Reverse Recovery Tset Conditions: $I_F = 10\text{mA}$, $I_R = 10\text{mA}$, $I_{rr} = 1.0\text{mA}$
4. Thermal Resistance from Junction to Ambient at .375" (9.5mm) lead lengths with both leads to heat sink.

RATINGS AND CHARACTERISTIC CURVES BY296P THRU BY299P

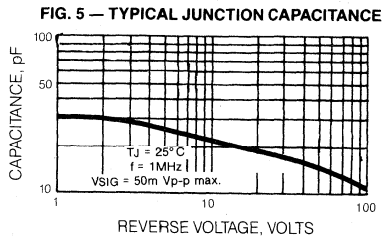
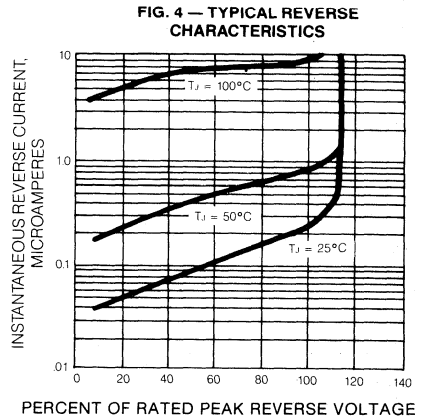
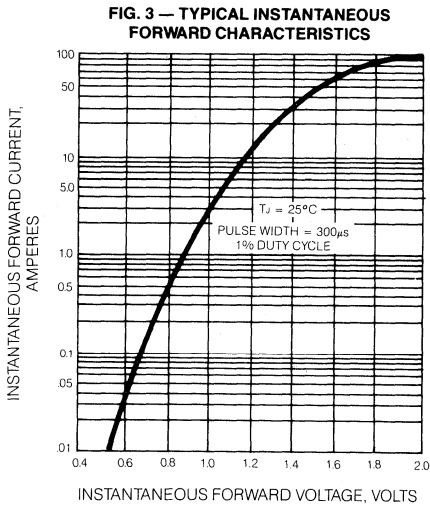
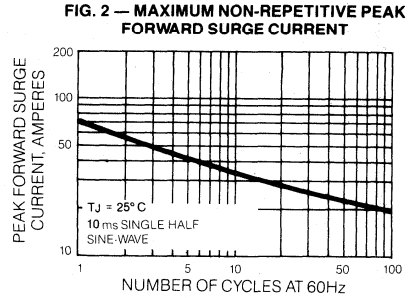
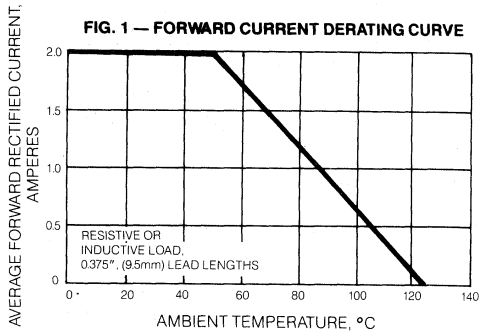

GI850 THRU GI856

SOFT RECOVERY, FAST SWITCHING PLASTIC RECTIFIER
VOLTAGE - 50 to 600 Volts CURRENT - 3.0 Amperes

FEATURES

DO-201AD

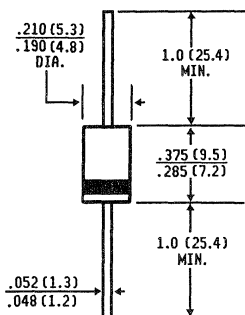

Dimensions in inches and (millimeters)

- ◆ High surge current capability
- ◆ The plastic package carries Underwriters Laboratory Flammability Classification 94V-O
- ◆ Fast switching for high efficiency
- ◆ Void-free plastic molded case
- ◆ High current operation
- ◆ High temperature soldering guaranteed: 265°C/10 seconds/.375", (9.5mm) lead lengths at 5 lbs., (2.3kg) tension

MECHANICAL DATA

Case: JEDEC DO-201AD molded plastic

Terminals: Plated Axial leads, solderable per MIL-STD-202, Method 208

Polarity: Color band denotes cathode

Mounting Position: Any

Weight: .04 ounce, 1.1 grams

MAXIMUM RATINGS AND ELECTRICAL CHARACTERISTICS

Ratings at 25°C ambient temperature unless otherwise specified.
 Resistive or inductive load. For capacitive load, derate current by 20%.

	SYMBOLS	GI850	GI851	GI852	GI854	GI856	UNITS
Maximum Recurrent Peak Reverse Voltage	V _{RRM}	50	100	200	400	600	Volts
Maximum RMS Voltage	V _{RMS}	35	70	140	280	420	Volts
Maximum DC Blocking Voltage	V _{DC}	50	100	200	400	600	Volts
Maximum Non-repetitive Peak Reverse Voltage	V _{RSM}	75	150	250	450	650	Volts
Maximum Average Forward Rectified Current .375", (9.5mm) lead lengths at T _A = 90°C	I _(AV)	3.0					Amps
Peak Forward Surge Current 8.3ms single half sine-wave superimposed on rated load (JEDEC Method)	I _{FSM}	100					Amps
Maximum Instantaneous Forward Voltage at 3A T _J = 25°C at 9.4A T _J = 175°C	V _F	1.25 1.10					Volts
Maximum DC Reverse Current T _A = 25°C at Rated DC Blocking Voltage T _A = 100°C	I _R	150	150	200	250	300	μA
Typical Junction Capacitance T _J = 25°C (Note 1)	C _J	28.0					pf
Maximum Reverse Recovery Time (Note 2) T _J = 25°C	T _{RR}	200					ns
Maximum Reverse Recovery Current (Note 2)	I _{RM(REC)}	2.0					Amps
Typical Thermal Resistance (Note 3)	R _{ΘJA}	15.0					°C/W
Operating and Storage Temperature Range,	T _J , T _{STG}	-50 to +150					°C

NOTES:

1. Measured at 1.0 MHz and applied reverse voltage of 4.0 Volts.
2. Reverse Recovery Test Conditions: I_F = 1.0A, V_R = 30V, di/dt = 50A/μs.
3. Thermal Resistance from Junction to Ambient at .375" (9.5mm) lead lengths, with both leads to heat sink.

RATINGS AND CHARACTERISTIC CURVES GI850 THRU GI856

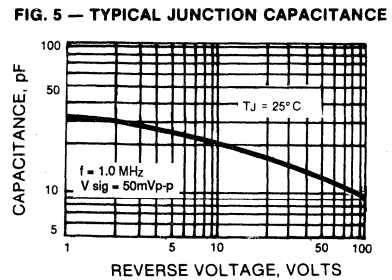
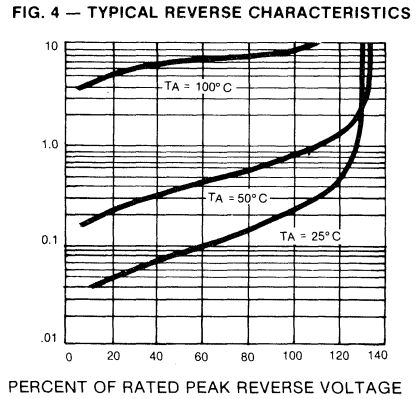
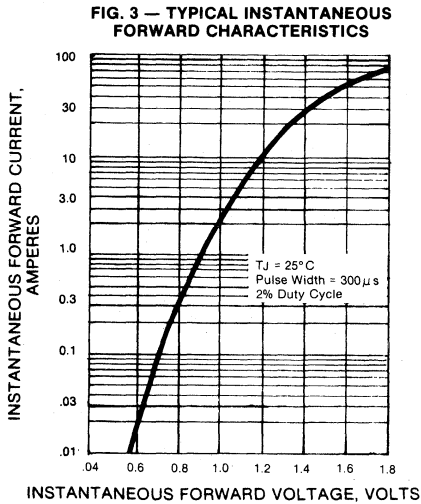
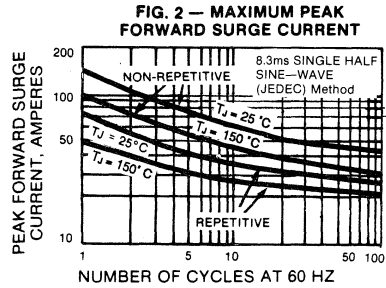
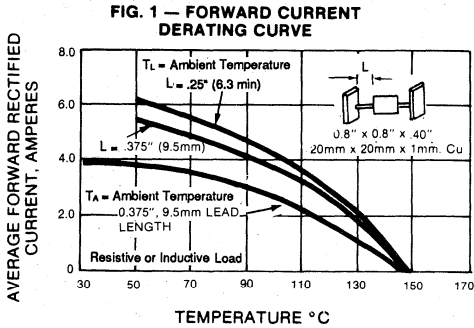

GI910 THRU GI917

SOFT RECOVERY MEDIUM-SWITCHING PLASTIC RECTIFIER
VOLTAGE - 50 to 800 Volts CURRENT - 3.0 Amperes

FEATURES

DO-201AD

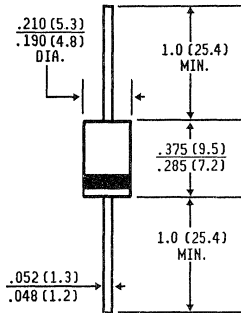

Dimensions in inches
and
(millimeters)

- ◆ High surge current capability
- ◆ The plastic package carries Underwriters Laboratory Flammability Classification 94V-O
- ◆ Void-free plastic
- ◆ High current operation 3.0 Amperes at $T_A = 90^\circ\text{C}$
- ◆ Fast switching for high efficiency
- ◆ High temperature soldering guaranteed: $265^\circ\text{C}/10$ seconds/.375", (9.5mm) lead lengths at 5 lbs., (2.3kg) tension

MECHANICAL DATA

Case: JEDEC DO-201AD molded plastic

Terminals: Axial leads, solderable per MIL-STD-202, Method 208

Polarity: Color Band denotes cathode

Mounting Position: Any

Weight: 0.04 ounce, 1.1 gram

MAXIMUM RATINGS AND ELECTRICAL CHARACTERISTICS

Ratings at 25°C ambient temperature unless otherwise specified
Resistive or inductive load. For capacitive load, derate current by 20%.

	SYMBOLS	GI910	GI911	GI912	GI914	GI916	GI917	UNITS
Maximum Recurrent Peak Reverse Voltage	V_{RRM}	50	100	200	400	600	800	Volts
Maximum RMS Voltage	V_{RMS}	35	70	140	280	420	560	Volts
Maximum DC Blocking Voltage	V_{DC}	50	100	200	400	600	800	Volts
Maximum Average Forward Rectified Current .375", (9.5mm) lead lengths at $T_A = 90^\circ\text{C}$	$I_{(AV)}$	3.0						Amps
Peak Forward Surge Current 8.3ms single half sine-wave superimposed on rated load (JEDEC Method)	I_{FSM}	100						Amps
Maximum Instantaneous Forward Voltage at 3.0A $T_J = 25^\circ\text{C}$ 9.4A $T_J = 175^\circ\text{C}$	V_F	1.25 1.10						Volts
Maximum DC Reverse Current at Rated DC Blocking Voltage $T_A = 25^\circ\text{C}$ $T_A = 100^\circ\text{C}$	I_R	10.0 300						μA
Typical Junction Capacitance (Note 1) $T_J = 25^\circ\text{C}$	C_J	28.0						pf
Maximum Reverse Recovery Time $T_J = 25^\circ\text{C}$ (Note 2)	T_{RR}	750						ns
Maximum Reverse Recovery Current	$I_{RM(REC)}$	2.0						Amps
Typical Thermal Resistance (Note 3)	$R_{\theta JA}$	15.0						$^\circ\text{C/W}$
Operating and Storage Temperature Range	T_J, T_{STG}	- 50 to +150						$^\circ\text{C}$

NOTES:

1. Measured at 1 MHz and applied reverse voltage of 4.0 Volts.
2. Reverse Recovery Test Conditions: $I_F = 1.0\text{A}$, $V_R = 30\text{V}$ di/dt = 50 A/ μs .
3. Thermal Resistance from Junction to Ambient at .375" (9.5mm) lead lengths, both leads to a heat sink.

RATINGS AND CHARACTERISTIC CURVES GI910 THRU GI917

FIG. 1 — FORWARD CURRENT DERATING CURVE

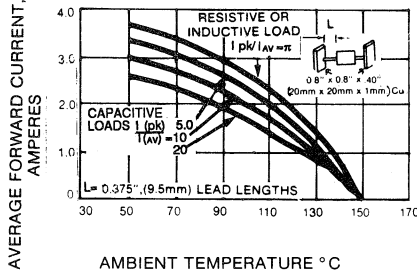

FIG. 3 — TYPICAL INSTANTANEOUS FORWARD CHARACTERISTICS

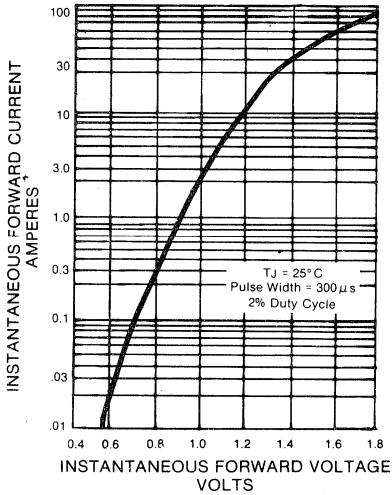

FIG. 5 — TYPICAL JUNCTION CAPACITANCE

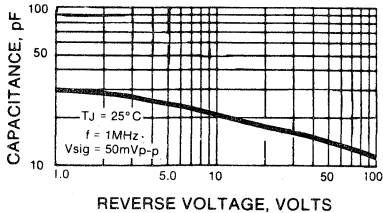

FIG. 2 — MAXIMUM FORWARD SURGE CURRENT

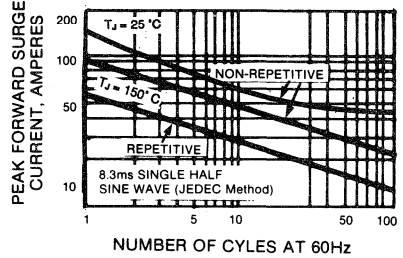

FIG. 4 — TYPICAL REVERSE CHARACTERISTICS

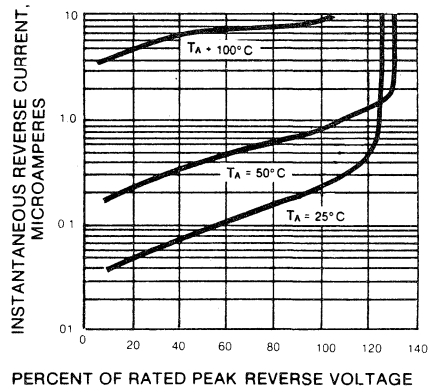
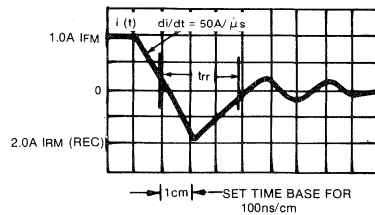
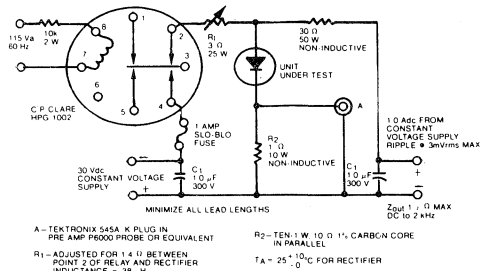

FIG. 6 — REVERSE RECOVERY TIME CHARACTERISTIC AND TEST CIRCUIT DIAGRAM



SRP300A THRU SRP300K

SOFT-RECOVERY, FAST-SWITCHING PLASTIC RECTIFIER

VOLTAGE - 50 to 800 Volts CURRENT - 3.0 Amperes

FEATURES

- ◆ High surge current capability
- ◆ The plastic package carries Underwriters Laboratory Flammability Classification 94V-0
- ◆ Void-free plastic package
- ◆ 3.0 Ampere operation at $T_A = 55^\circ\text{C}$ with no thermal runaway
- ◆ Fast switching for high efficiency
- ◆ High temperature soldering guaranteed: $265^\circ\text{C}/10$ seconds/.375" (9.5mm) lead lengths at 5 lbs., (2.3kg) tension

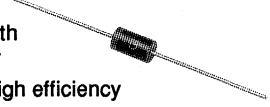

DO-201AD

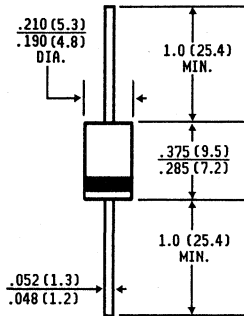

Dimension in inches
and
(millimeters)

MECHANICAL DATA

Case: JEDEC DO-201AD molded plastic

Terminals: Plated Axial leads, solderable per MIL-STD-202, Method 208

Polarity: Color Band denotes cathode

Mounting Position: Any

Weight: 0.04 ounce, 1.1 grams

MAXIMUM RATINGS AND ELECTRICAL CHARACTERISTICS

Ratings at 25°C ambient temperature unless otherwise specified.
Single phase, half wave, 60 HZ, resistive or inductive load.
For capacitive load, derate current by 20%.

	SYMBOLS	SRP 300A	SRP 300B	SRP 300D	SRP 300G	SRP 300J	SRP 300K	UNITS
Maximum Recurrent Peak Reverse Voltage	V_{RRM}	50	100	200	400	600	800	Volts
Maximum RMS Voltage	V_{RMS}	35	70	140	280	420	560	Volts
Maximum DC Blocking Voltage	V_{DC}	50	100	200	400	600	800	Volts
Maximum Average Forward Rectified Current .375", (9.5mm) lead lengths at $T_A = 55^\circ\text{C}$	$I_{(AV)}$	3.0						Amps
Peak Forward Surge Current 8.3ms single half sine-wave superimposed on rated load (JEDEC Method)	I_{FSM}	150						Amps
Maximum Instantaneous Forward Voltage at 3.0A	V_F	1.3						Volts
Maximum DC Reverse Current $T_A = 25^\circ\text{C}$	I_R	10.0						μA
at Rated DC Blocking Voltage $T_A = 100^\circ\text{C}$		200		300	400	500		
Maximum Reverse Recovery Time (Note 2) $T_J = 25^\circ\text{C}$	T_{RR}	100	100	150	150	200	200	ns
Typical Junction Capacitance (Note 1) $T_J = 25^\circ\text{C}$	C_J	28.0						pf
Typical Thermal Resistance (Note 3)	$R_{\theta JA}$	15.0						$^\circ\text{C}/\text{W}$
Storage and Operating Temperature Range,	T_J, T_{STG}	-50 to +150						$^\circ\text{C}$

NOTES:

1. Measured at 1 MHz and applied reverse voltage of 4.0 volts.
2. Reverse Recovery Test Conditions: $I_F = 0.5\text{A}$, $I_R = 1.0\text{A}$, $I_{rr} = .25\text{A}$.
3. Thermal Resistance from Junction to Ambient at .375" (9.5mm) lead lengths with both leads to heat sink.

RATINGS AND CHARACTERISTIC CURVES SRP300A THRU SRP300K

AVERAGE FORWARD RECTIFIED CURRENT, AMPERES.

FIG. 1 — FORWARD CURRENT DERATING CURVE

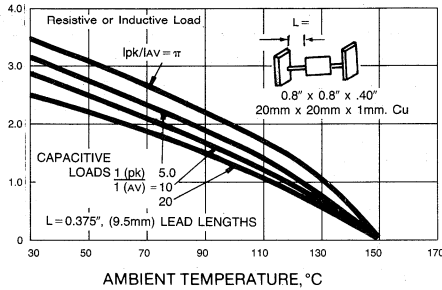

FIG. 2 — MAXIMUM NON-REPETITIVE PEAK FORWARD SURGE CURRENT

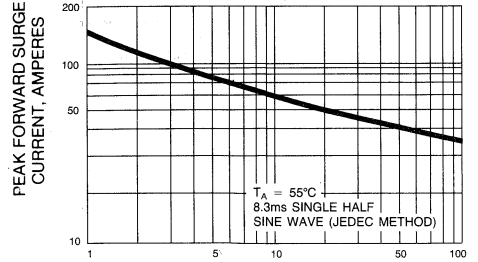

FIG. 3 — TYPICAL INSTANTANEOUS FORWARD CHARACTERISTICS

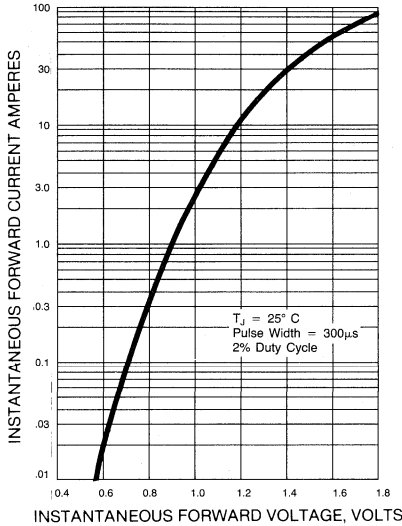

FIG. 4 — TYPICAL REVERSE CHARACTERISTICS

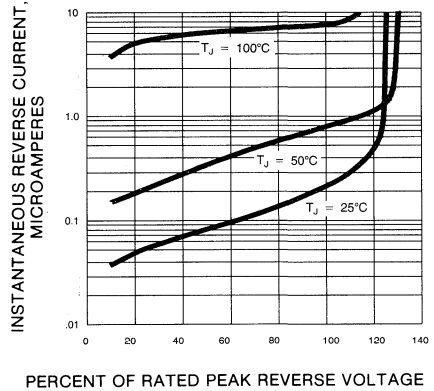

FIG. 5 — TYPICAL JUNCTION CAPACITANCE

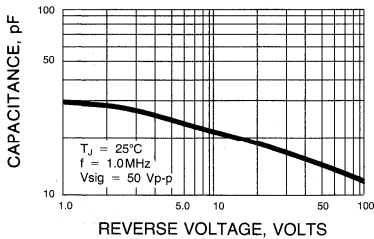
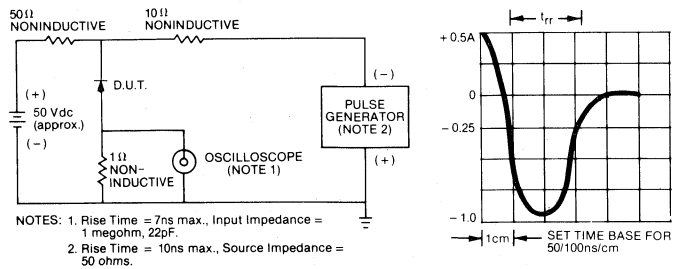

FIG. 6 — REVERSE RECOVERY TIME CHARACTERISTIC AND TEST CIRCUIT DIAGRAM



BY396P THRU BY399P

SOFT RECOVERY, FAST SWITCHING PLASTIC RECTIFIER

VOLTAGE - 100 to 800 Volts **CURRENT - 3.0 Amperes**

FEATURES

- ◆ High surge current capability
- ◆ The plastic package carries Underwriters Laboratory Flammability Classification 94V-0
- ◆ Void-free plastic package
- ◆ 3.0 Ampere operation at $T_A = 50^\circ\text{C}$ with no thermal runaway
- ◆ Fast switching for high efficiency
- ◆ High temperature soldering guaranteed: $265^\circ\text{C}/10$ seconds/.375" (9.5mm) lead lengths at 5 lbs., (2.3kg) tension

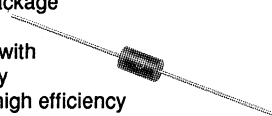

DO-201AD

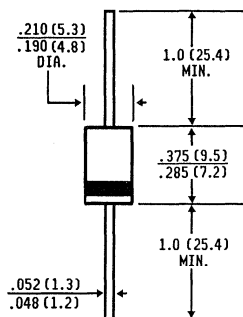

Dimensions in inches
and
(millimeters)

MECHANICAL DATA

Case: JEDEC DO-201AD molded plastic
Terminals: Plated Axial leads, solderable per MIL-STD-202, Method 208
Polarity: Color Band denotes Cathode end
Mounting Position: Any
Weight: .04 ounce, 1.1 gram

MAXIMUM RATINGS AND ELECTRICAL CHARACTERISTICS

Ratings at 25°C ambient temperature unless otherwise specified
 Single phase, half wave, 60 Hz, resistive or inductive load.
 For capacitive load, derate current by 20%.

	SYMBOLS	BY396P	BY397P	BY398P	BY399P	UNITS
Maximum Recurrent Peak Reverse Voltage	V_{RRM}	100	200	400	800	Volts
Maximum RMS Voltage	V_{RMS}	70	140	280	560	Volts
Maximum DC Blocking Voltage	V_{DC}	100	200	400	800	Volts
Maximum Average Forward Rectified Current .375", (9.5mm) lead lengths at $T_A = 50^\circ\text{C}$	$I_{(AV)}$	3.0				Amps
Peak Forward Surge Current 10ms single half sine-wave superimposed on rated load at $T_A = 25^\circ\text{C}$	I_{FSM}	100				Amps
Maximum Repetitive Peak Forward Surge (Note 1)	I_{FRM}	10.0				Amps
Maximum Instantaneous Forward Voltage at 3.0A	V_F	1.25				Volts
Maximum DC Reverse Current $T_A = 25^\circ\text{C}$ at Rated DC Blocking Voltage $T_A = 100^\circ\text{C}$	I_R	500				μA
Maximum Reverse Recovery Time (Note 3) $T_J = 25^\circ\text{C}$	T_{RR}	500.0				ns
Maximum Forward Recovery Time 100mA $T_J = 25^\circ\text{C}$	T_{FR}	1.0				μs
Typical Junction Capacitance (Note 2)	C_J	28.0				pf
Typical Thermal Resistance (Note 4)	$R_{\theta JA}$	15.0				$^\circ\text{C}/\text{W}$
Operating Temperature Range	T_J	-50 to +125				$^\circ\text{C}$
Storage Temperature Range	T_{STG}	-50 to +150				$^\circ\text{C}$

NOTES:

1. Repetitive Peak Forward Surge Current at $f < 15\text{KHz}$.
2. Measured at 1 MHz and applied reverse voltage of 4.0 volts.
3. Reverse Recovery Test Conditions: $I_F = 10\text{mA}$, $I_R = 10\text{mA}$, $I_{rr} = 1.0\text{mA}$.
4. Thermal Resistance from Junction to Ambient at .375" (9.5mm) lead lengths with both leads to heat sink.

RATINGS AND CHARACTERISTIC CURVES BY396P THRU BY399P

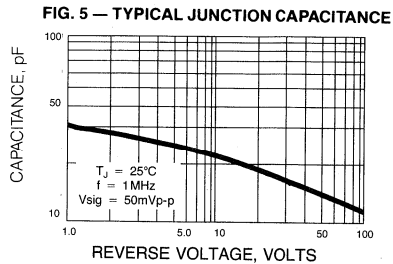
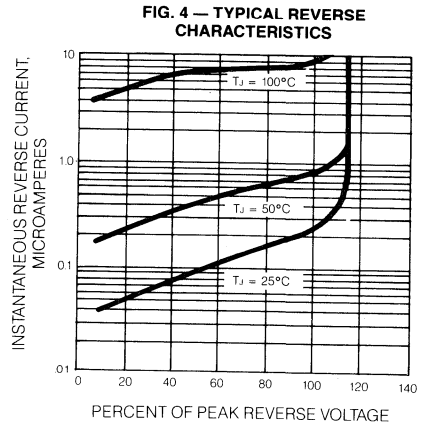
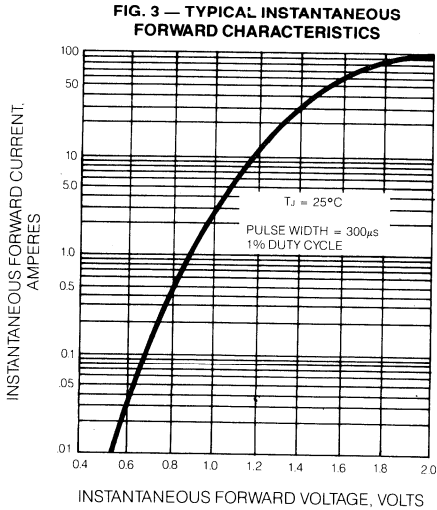
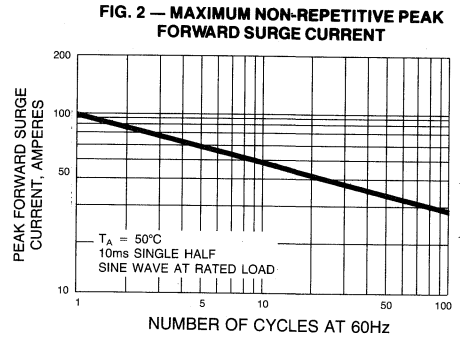
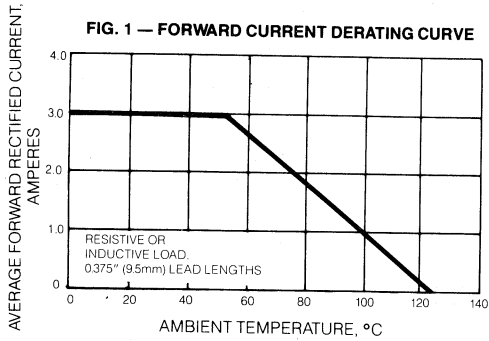

BY500-100 THRU BY500-600

SOFT RECOVERY, FAST SWITCHING PLASTIC RECTIFIER

VOLTAGE - 100 to 800 Volts CURRENT - 5.0 Ampere

FEATURES

DO-201AD

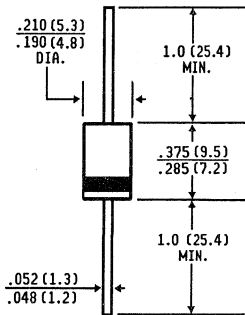

Dimensions in inches
and
(millimeters)

- ◆ High surge current capability
- ◆ The plastic package carries Underwriters Laboratory Flammability Classification 94V-O
- ◆ Fast switching for high efficiency
- ◆ High current 5.0 Ampere operation at $T_L = 45^\circ\text{C}$
- ◆ Void-free plastic package
- ◆ High temperature soldering guaranteed: $265^\circ\text{C}/10$ seconds $.375"$, (9.5mm) lead lengths at 5 lbs., (2.3kg) tension
- ◆ Especially designed for applications such as Switch Mode Power Supplies, Inverters, Converters, TV Scanning, Ultrasonic-Systems, speed controlled DC Motors, low RF Interference and free Wheeling Rectifiers

MECHANICAL DATA

Case: JEDEC DO-201AD molded plastic

Terminals: Plated Axial leads, solderable per MIL-STD-202, Method 208

Polarity: Color Band denotes Cathode end

Mounting Position: Any

Weight: .04 ounce, 1.1 gram

MAXIMUM RATINGS AND ELECTRICAL CHARACTERISTICS

Ratings at 25°C ambient temperature unless otherwise specified Resistive or inductive load. For capacitive load, derate current by 20%.

	SYMBOLS	BY500-100	BY500-200	BY500-400	BY500-600	UNITS
Maximum Recurrent Peak Reverse Voltage	V_{RRM}	100	200	400	800	Volts
Maximum RMS Voltage	V_{RMS}	70	140	280	560	Volts
Maximum DC Blocking Voltage	V_{DC}	100	200	400	800	Volts
Maximum Average Forward Rectified Current .375", (9.5mm) lead lengths at $T_L = 45^\circ\text{C}$	$I_{(AV)}$	5.0				Amps
Peak Forward Surge Current 8.3ms single half sine-wave superimposed on rated load at $T_A = 25^\circ\text{C}$	I_{FSM}	200				Amps
Maximum Repetitive Peak Forward Surge	I_{FRM}	10.0				Amps
Maximum Instantaneous Forward Voltage at 5.0A	V_F	1.35				Volts
Maximum DC Reverse Current $T_A = 25^\circ\text{C}$ at Rated DC Blocking Voltage $T_A = 100^\circ\text{C}$	I_R	10.0 1.0				μA mA
Maximum Reverse Recovery Time (Note 3) $T_J = 25^\circ\text{C}$	T_{RR}	200				ns
Maximum Reverse Recovery Current (Note 3)	$I_{RM(REC)}$	2.0				Apk
Typical Junction Capacitance $T_J = 25^\circ\text{C}$ (Note 2)	C_J	28.0				pf
Typical Thermal Resistance (Note 1)	$R_{\theta JA}$	15.0				$^\circ\text{C}/\text{W}$
Operating Temperature Range	T_J	-50 to +125				$^\circ\text{C}$
Storage Temperature Range	T_{STG}	-50 to +150				$^\circ\text{C}$

NOTES:

1. Thermal Resistance from Junction to Ambient at $375"$, (9.5mm) lead lengths with both leads to heat sink.
2. Measured at 1 MHz and applied reverse voltage of 4.0 volts.
3. Reverse Recovery Test Conditions: $I_F = 1.0\text{A}$, $V_R = 30\text{V}$ $di/dt = 50\text{A}/\mu\text{s}$.

RATINGS AND CHARACTERISTIC CURVES BY500-100 THRU BY500-600

FIG. 1 — FORWARD CURRENT DERATING CURVE

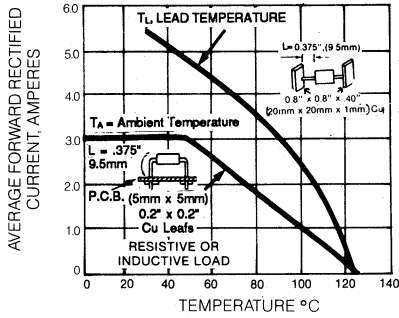

FIG. 3 — TYPICAL INSTANTANEOUS FORWARD CHARACTERISTICS

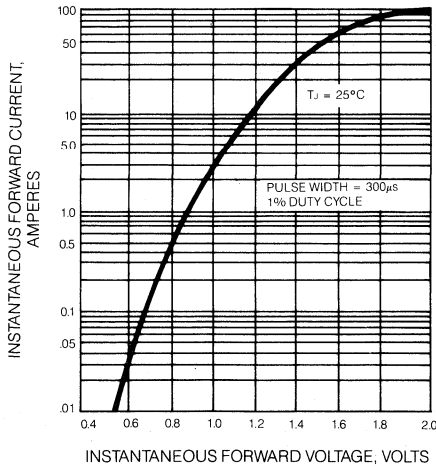

Fig. 2 — TYPICAL REVERSE CHARACTERISTICS

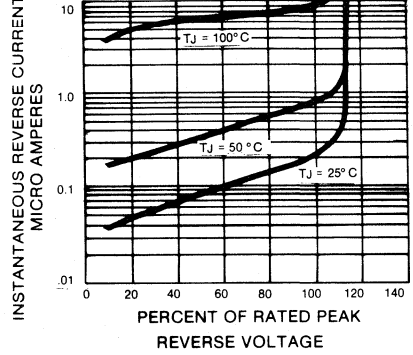

FIG. 4 — MAXIMUM PEAK FORWARD SURGE CURRENT

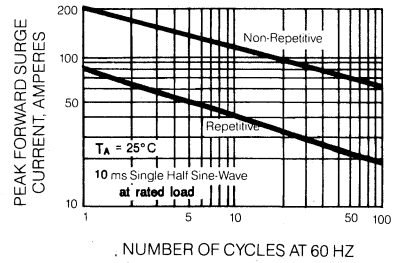
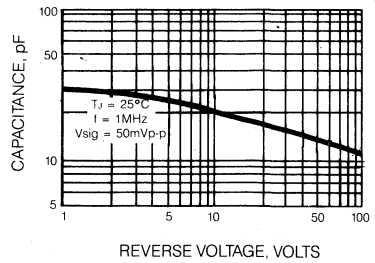

FIG. 5 — TYPICAL JUNCTION CAPACITANCE



GI820 THRU GI826

HIGH CURRENT FAST SWITCHING PLASTIC RECTIFIER
VOLTAGE - 50 to 600 Volts CURRENT - 5.0 Amperes

FEATURES

- ◆ The plastic package carries Underwriters Laboratory Flammability Classification 94V-0
- ◆ High surge current capability
- ◆ High current operation
- ◆ Fast switching for high efficiency
- ◆ Diffused junction
- ◆ Completely insulated case
- ◆ Uniform molded body
- ◆ High temperature soldering guaranteed: 265°C/10 seconds/.375" (9.5mm) lead lengths at 5 lbs., (2.3kg) tension

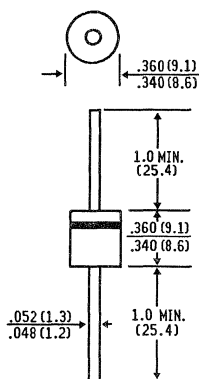

Dimensions in inches
and
(millimeters)

MECHANICAL DATA

Case: Molded plastic

Terminals: Plated Axial leads, solderable per MIL-STD-202, Method 208

Polarity: Color Band denotes cathode

Mounting Position: Any

Weight: 0.07 ounce, 2.1 grams

MAXIMUM RATINGS AND ELECTRICAL CHARACTERISTICS

Ratings at 25°C ambient temperature unless otherwise specified.
Resistive or inductive load. For capacitive load, derate current by 20%.

	SYMBOLS	GI820	GI821	GI822	GI824	GI826	UNITS
Maximum Recurrent Peak Reverse Voltage	V _{RRM}	50	100	200	400	600	Volts
Maximum RMS Voltage	V _{RMS}	35	70	140	280	420	Volts
Maximum DC Blocking Voltage	V _{DC}	50	100	200	400	600	Volts
Maximum Non-repetitive Peak Reverse Voltage	V _{RSM}	75	150	250	450	650	Volts
Maximum Average Forward Rectified Current .375", (9.5mm) lead lengths at T _A = 55°C	I _(AV)	5.0					Amps
Peak Forward Surge Current 8.3ms single half sine-wave superimposed on rated load (JEDEC Method)	I _{FSM}	300					Amps
Maximum Instantaneous Forward Voltage at 5.0A at 15.7A T _J = 150°C	V _F	1.10 1.05					Volts
Maximum Reverse Current T _A = 25°C at Rated DC Blocking Voltage T _A = 100°C	I _R	10.0 1.0					μA mA
Typical Junction Capacitance T _J = 25°C (Note 3)	C _J	300					pf
Maximum Reverse Recovery Time (Note 1) T _J = 25°C	T _{RR}	200					nS
Maximum Reverse Recovery Current (Note 1)	I _{RM(REC)}	2.0					Amps
Typical Thermal Resistance (Note 2)	R _{θJA}	10.0					°C/W
Operating and Storage Temperature Range,	T _J , T _{STG}	-50 to +150					°C

NOTES:

1. Reverse Recovery Test Conditions: I_F = 1.0A, V_R = 30V, di/dt = 50A/μs.
2. Thermal Resistance from Junction to Ambient at .375" (9.5mm) lead lengths, with both leads to heat sink.
3. Measured at 1 MHz and applied reverse voltage of 4.0 volts.

RATINGS AND CHARACTERISTIC CURVES G1820 THRU G1826

FIG. 1 — FORWARD CURRENT DERATING CURVE

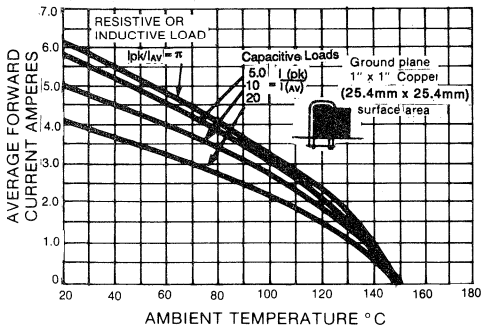

FIG. 2 — FORWARD CURRENT DERATING CURVE

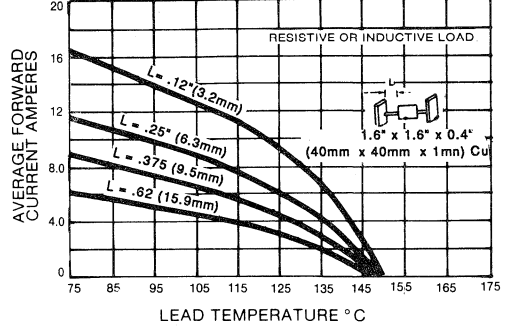

FIG. 3 — TYPICAL INSTANTANEOUS FORWARD CHARACTERISTICS

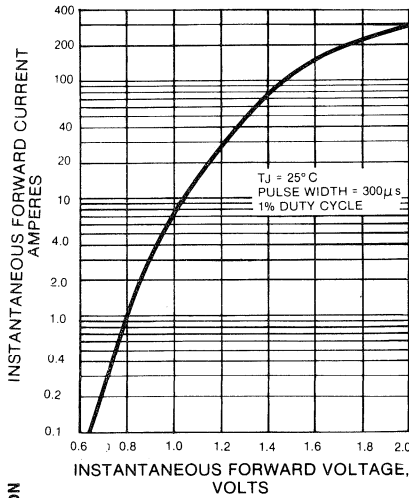

FIG. 4 — MAXIMUM NON-REPETITIVE PEAK FORWARD SURGE CURRENT

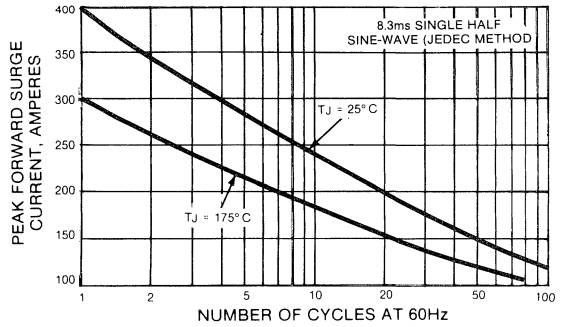

FIG. 6 — TYPICAL REVERSE CHARACTERISTICS

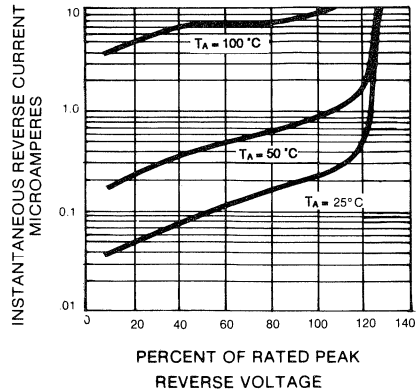
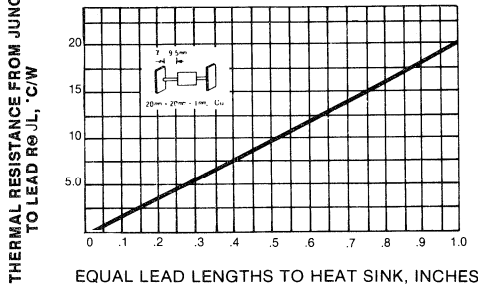

FIG. 5 — TYPICAL THERMAL RESISTANCE



SRP600A THRU SRP600K

HIGH CURRENT SOFT RECOVERY FAST-SWITCHING PLASTIC RECTIFIER

VOLTAGE - 50 to 800 Volts CURRENT - 6.0 Amperes

FEATURES

- ◆ The plastic package carries Underwriters Laboratory Flammability Classification 94V-0
- ◆ High surge current capability
- ◆ High current operation
- ◆ Void-free plastic package
- ◆ Fast switching for high efficiency
- ◆ High temperature soldering guaranteed: 265°C/10 seconds/.375" (9.5mm) lead lengths at 5 lbs., (2.3kg) tension

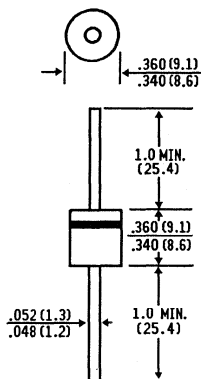

Dimensions in inches
and
(millimeters)

MECHANICAL DATA

Case: Molded plastic

Terminals: Plated Axial leads, solderable per MIL-STD-202, Method 208

Polarity: Color Band denotes cathode

Mounting Position: Any

Weight: 0.07 ounce, 2.1 gram

MAXIMUM RATINGS AND ELECTRICAL CHARACTERISTICS

Ratings at 25°C ambient temperature unless otherwise specified.
Resistive or inductive load. For capacitive load, derate current by 20%.

	SYMBOLS	SRP 600A	SRP 600B	SRP 600D	SRP 600G	SRP 600J	SRP 600K	UNITS
Maximum Recurrent Peak Reverse Voltage	V_{RRM}	50	100	200	400	600	800	Volts
Maximum RMS Voltage	V_{RMS}	35	70	140	280	420	560	Volts
Maximum DC Blocking Voltage	V_{DC}	50	100	200	400	600	800	Volts
Maximum Average Forward Rectified Current .375", (9.5mm) lead lengths at $T_A = 55^\circ\text{C}$	$I_{(AV)}$	6.0						Amps
Peak Forward Surge Current 8.3ms single half sine-wave superimposed on rated load (JEDEC Method)	I_{FSM}	300						Amps
Maximum Instantaneous Forward Voltage at 6.0A	V_F	1.3						Volts
Maximum DC Reverse Current $T_A = 25^\circ\text{C}$ at Rated DC Blocking Voltage $T_A = 100^\circ\text{C}$	I_R	1.0						μA mA
Maximum Reverse Recovery Time (Note 1) $T_J = 25^\circ\text{C}$	T_{RR}	100	100	150	150	200	200	ns
Typical Junction Capacitance (Note 2) $T_J = 25^\circ\text{C}$	C_J	300						pf
Typical Thermal Resistance (Note 3)	$R_{\theta JA}$	10.0						$^\circ\text{C/W}$
Operating Temperature Range	T_J	- 50 to +125						$^\circ\text{C}$
Storage Temperature Range	T_{STG}	-50 to +150						$^\circ\text{C}$

NOTES:

1. Reverse Recovery Test Conditions: $I_F = 0.5\text{A}$, $I_R = 1.0\text{A}$, $I_{rr} = .25\text{A}$.
2. Measured at 1 MHz and applied reverse voltage of 4.0 Volts.
3. Thermal Resistance from Junction to Ambient at .375" (9.5mm) lead lengths, with both leads to heat sink.

RATINGS AND CHARACTERISTIC CURVES SRP600A THRU SRP600K

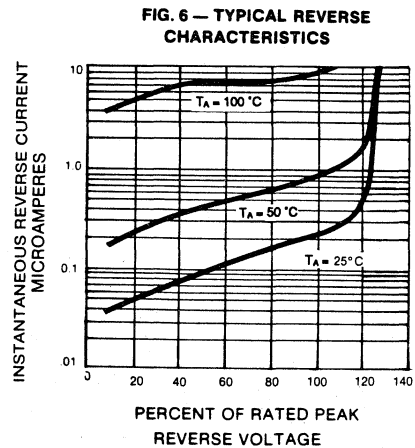
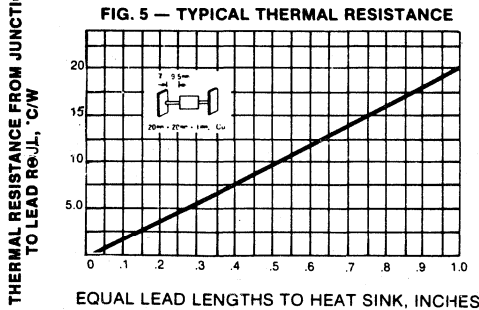
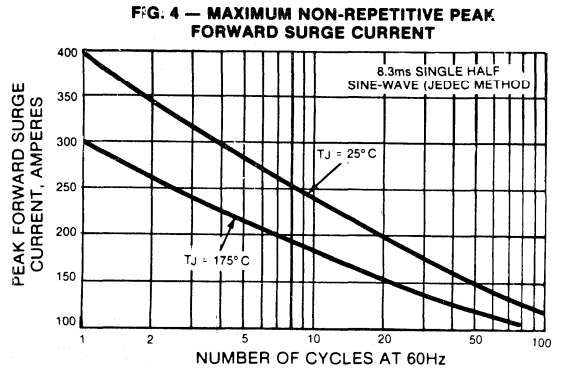
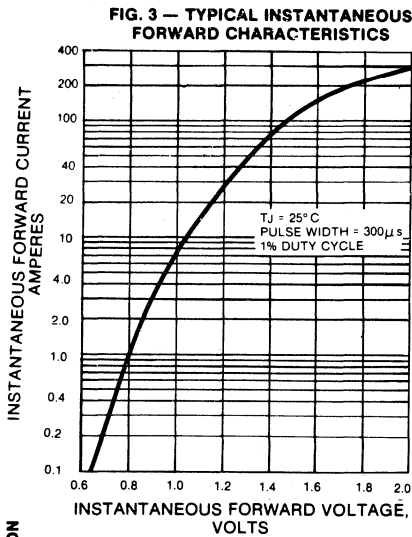
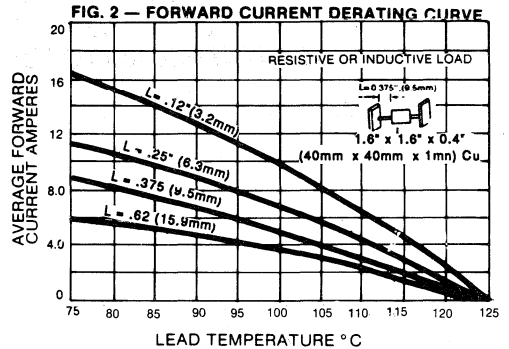
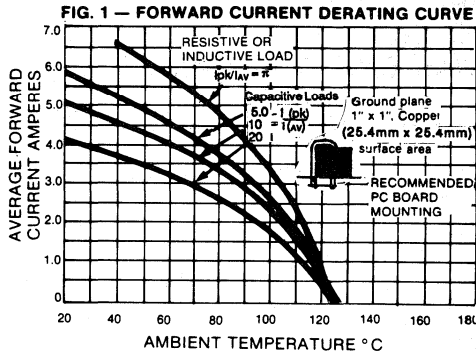

RSF8AT THRU RSF8MT

FAST SWITCHING GLASS PASSIVATED RECTIFIER
VOLTAGE - 50 to 1000 Volts CURRENT - 8.0 Amperes

FEATURES

- ◆ Isolated Overmolded Package
- ◆ The plastic package carries Underwriters Laboratory Flammability Classification 94V-O
- ◆ High surge capacity
- ◆ High current capability
- ◆ Low forward voltage
- ◆ Fast switching for high efficiency
- ◆ Glass passivated junction
- ◆ Internal Insulation: 1.5k VRMS

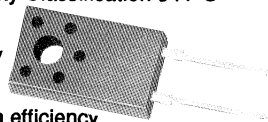

ITO-220

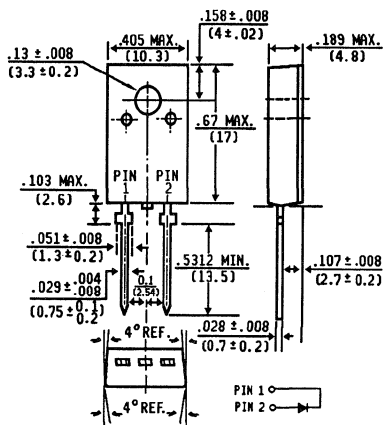

Dimensions in inches and (millimeters)

MECHANICAL DATA

Case: ITO-220 fully overmolded plastic

Terminals: Lead solderable per MIL-STD-202, Method 208

Polarity: As marked

Weight: .08 ounces, 2.24 grams

Mounting Position: Any

Mounting Torque: 5 in. - lbs. max.

MAXIMUM RATINGS AND ELECTRICAL CHARACTERISTICS

Ratings at 25°C ambient temperature unless otherwise specified.
 Single phase, half wave, 60 Hz, resistive or inductive load.
 For capacitive load, derate current by 20%.

	SYMBOLS	RSF8 AT	RSF8 BT	RSF8 DT	RSF8 GT	RSF8 JT	RSF8 KT	RSF8 MT	UNITS
Maximum Recurrent Peak Reverse Voltage	V _{RRM}	50	100	200	400	600	800	1000	Volts
Maximum RMS Voltage	V _{RMS}	35	70	140	280	420	560	700	Volts
Maximum DC Blocking Voltage	V _{DC}	50	100	200	400	600	800	1000	Volts
Maximum Average Forward Rectified Current at T _C = 100°C	I _(AV)	8.0							Amps
Peak Forward Surge Current 8.3ms single half sine-wave superimposed on rated load (JEDEC Method)	I _{FSM}	150							Amps
Maximum Instantaneous Forward Voltage at 8.0A	V _F	1.3							Volts
Maximum Reverse Current T _C = 25°C at Rated DC Blocking Voltage T _C = 100°C	I _R	10.0 250							μA
Maximum Reverse Recovery Time (Note 2) T _J = 25°C	T _{RR}	150		200	250		500	ns	
Typical Junction Capacitance (Note 1)	C _J	55							pf
Typical Thermal Resistance (Note 3)	R _{θJC}	3.0							°C/W
Operating and Storage Temperature Range	T _C , T _{STG}	-65 to +150							°C

NOTES:

1. Measured at 1.0 MHz and applied reverse voltage of 4.0 V_{DC}.
2. Reverse Recovery Test Conditions : I_F = 0.5A, I_R = 1.0A, I_{rr} = .25A.
3. Thermal Resistance from Junction to Case.

RATING AND CHARACTERISTIC CURVES RSF8AT THRU RSF8MT

Fig. 1 — FORWARD CURRENT DERATING CURVE

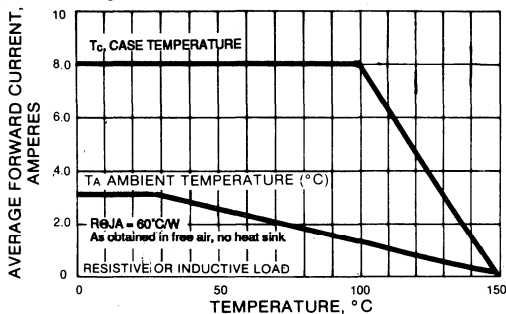

Fig. 2 — TYPICAL INSTANTANEOUS FORWARD CHARACTERISTICS

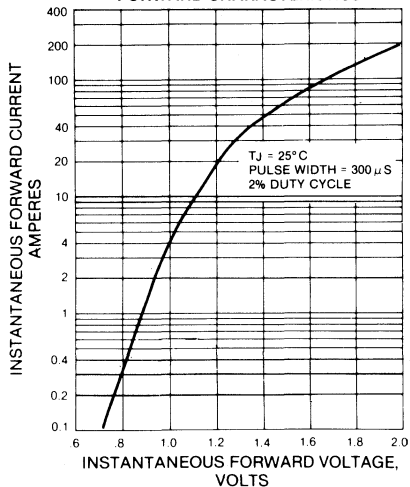

FIG. 3 — MAXIMUM NON-REPETITIVE PEAK FORWARD SURGE CURRENT

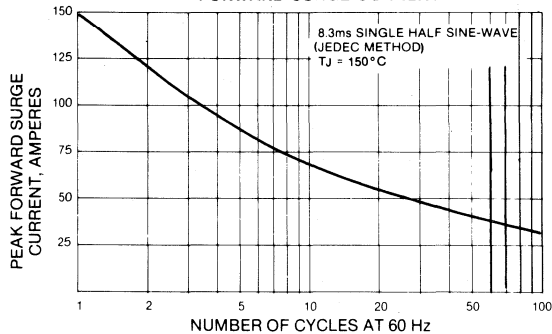

Fig. 4 — TYPICAL REVERSE CHARACTERISTICS

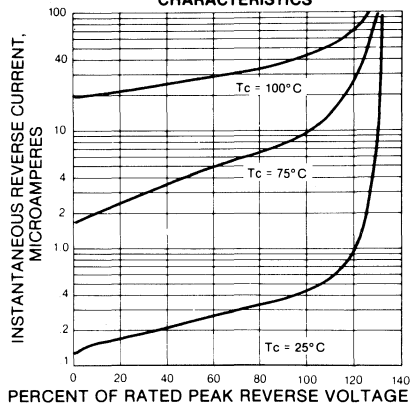
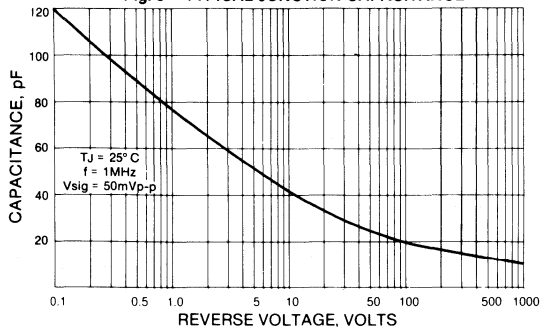

Fig. 5 — TYPICAL JUNCTION CAPACITANCE



RS8AT THRU RS8MT

HIGH CURRENT FAST SWITCHING PLASTIC RECTIFIER
VOLTAGE - 50 to 1000 Volts CURRENT - 8.0 Amperes

FEATURES

- ◆ The plastic package carries Underwriters Laboratory Flammability Classification 94V-O
- ◆ High forward surge capability
- ◆ High current operation
- ◆ Low forward voltage drop
- ◆ Fast switching for high efficiency
- ◆ Glass passivated chip junction
- ◆ High temperature soldering guaranteed:
265°C/10 seconds/.25", (6.35mm) lead lengths at 5 lbs., (2.3kg) tension

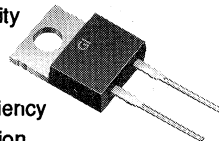

TO-220

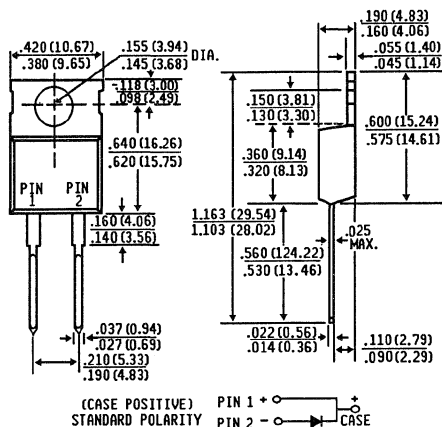

Dimensions in inches and (millimeters)

MECHANICAL DATA

Case: JEDEC TO-220 molded plastic

Terminals: Plated Leads solderable per MIL-STD-202, Method 208

Polarity: As marked

Weight: .08 ounces, 2.224 grams

Mounting Position: Any

MAXIMUM RATINGS AND ELECTRICAL CHARACTERISTICS

Ratings at 25°C ambient temperature unless otherwise specified.
 Single phase, half wave, 60 Hz, resistive or inductive load.
 For capacitive load, derate current by 20%.

SYMBOLS	RS8 AT	RS8 BT	RS8 DT	RS8 GT	RS8 JT	RS8 KT	RS8 MT	UNITS	
Maximum Recurrent Peak Reverse Voltage	VRRM	50	100	200	400	600	800	1000 Volts	
Maximum RMS Voltage	VRMS	35	70	140	280	420	560	700 Volts	
Maximum DC Blocking Voltage	VDC	50	100	200	400	600	800	1000 Volts	
Maximum Average Forward Rectified Current at T _c = 100°C	I(AV)	8.0						Amps	
Peak Forward Surge Current 8.3ms single half sine-wave superimposed on rated load (JEDEC Method)	IFSM	150						Amps	
Maximum Instantaneous Forward Voltage at 8.0A	VF	1.3						Volts	
Maximum Reverse Current T _J = 25°C at Rated DC Blocking Voltage T _c = 100°C	IR	10.0						250	μA
Maximum Reverse Recovery Time (Note 2) T _J = 25°C	T _{RR}	150		200	250		500	ns	
Typical Junction Capacitance (Note 1)	C _J	55						pf	
Typical Thermal Resistance (Note 3)	RθJC	3.0						°C/W	
Operating and Storage Temperature Range,	T _J , T _{STG}	-50 to +150						°C	

NOTES:

1. Measured at 1.0 MHz and applied reverse voltage of 4.0 V_{dc}.
2. Reverse Recovery Test Conditions : I_F = 0.5A, I_R = 1.0A, I_{rr} = .25A.
3. Thermal Resistance from Junction to Case attached to heat sink.

RATINGS AND CHARACTERISTIC CURVES RS8AT THRU RS8MT

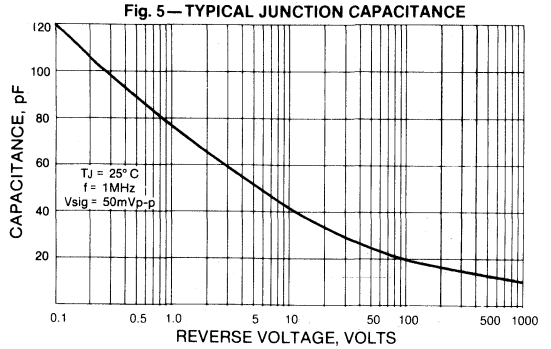
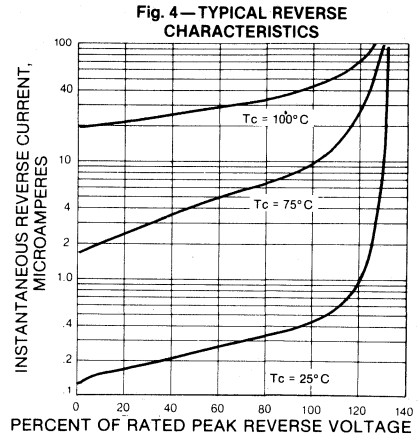
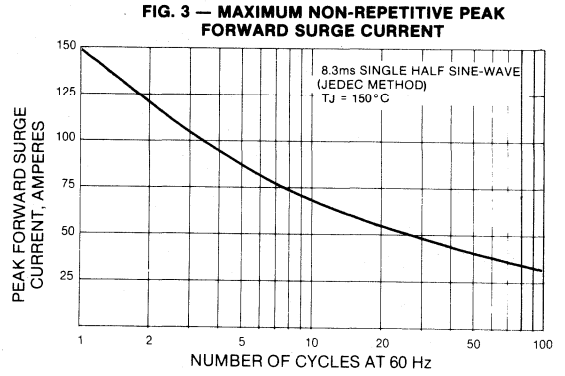
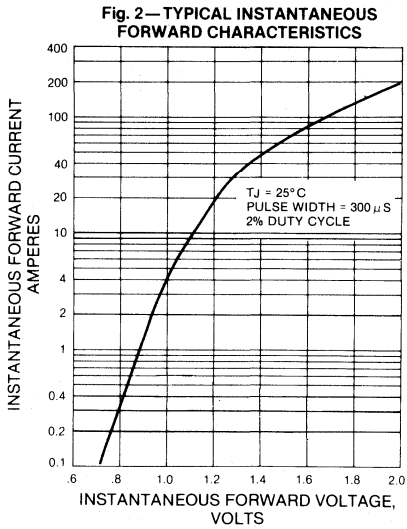
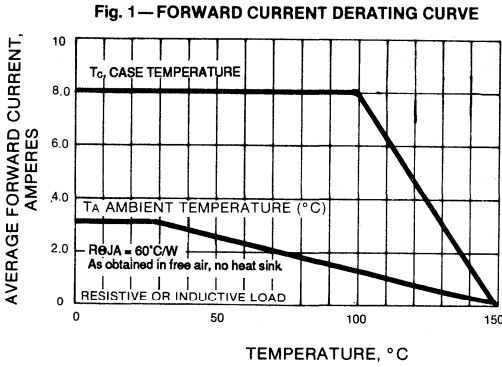

BRIDGE RECTIFIERS

***0.9 AMPERE TO 35 AMPERES
50 VOLTS TO 1000 VOLTS***

**GENERAL
INSTRUMENT**

BRIDGE RECTIFIERS

0.9 to 35 Amperes 50 Volts to 1000 Volts

Families of General Instrument Bridge Rectifiers

All types of rectifier cells, which are produced by GENERAL INSTRUMENT, are available in bridge configurations, molded in various plastic packages.

The basic types of packages are

- Round Plastic Package (Fig. 1)
- IN-LINE Plastic Package (Fig. 2)
- DUAL-IN-LINE Plastic Package (Fig. 3)
- Square Plastic Package for Chassis Mounting (Fig. 4)

These bridge families are available with different terminals, such as wire leads, FASTON or soldering lugs.

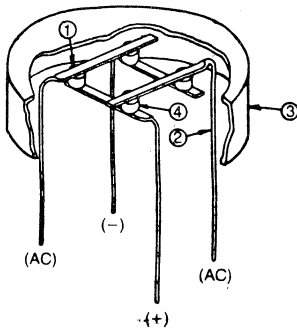

Fig. 1 Round Bridge

- ITEM DESCRIPTION
1. Solder Preforms
 2. Formed Copper Leads
 3. Plastic Case
 4. Cells or GPP Chips

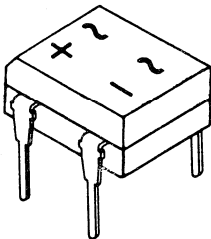

Fig. 3 DUAL-IN-LINE Bridge

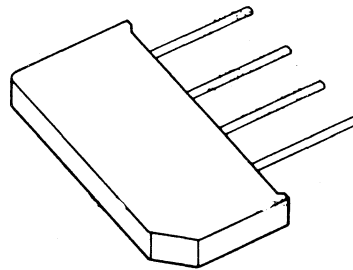

Fig. 2 IN-LINE Bridge

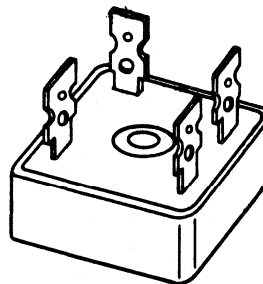

Fig. 4 Chassis Mounted Bridge

FAMILIES OF GENERAL INSTRUMENT BRIDGE RECTIFIERS

Dual-In-Line Single Phase Bridge Rectifiers 0.9 to 1.0 AMPERE

Types:

DF005M thru DF10M
 RDF005M thru RDF08M
 (Fast Recovery)

B40C80DM - B380C800DM

Features:

- ◆ Surge Overload Rating 50 Amperes Peak
- ◆ Ideal for Printed Circuit Board
- ◆ Reliable Low Cost Construction
- ◆ Tinned Copper Leads Solderable to MIL-STD-202 Method 208
- ◆ Glass Passivated Chip Junctions
- ◆ Plastic Package has Underwriters Laboratory Flammability Classification 94V-0
- ◆ All bridge series are UL recognized under component index, file number E54214

Miniature Single-Phase Bridge Rectifiers 1.5 to 2 AMPERES

Types:

W005M thru W10M
 2W005M thru 2W10M
 B40C800 (M) thru B250C800 (M)
 B40C1000 (M) thru B380C10000 (M)
 B40C1500 (M) thru B380C1500 (M)
W005G thru W10G*
AW02G thru AW08G*
RW005G thru RW08G* (Fast Recovery)

Features:

- ◆ Surge Overload Rating 50 and 60 Amperes Peak
- ◆ Ideal for Printed Circuit Board
- ◆ Reliable Low Cost Construction
- ◆ Leads are Solderable to MIL-STD-202 Method 208
- ◆ Plastic Package has Underwriters Laboratory Flammability Classification 94V-0
- ◆ All bridge series are UL recognized under component index, file number E54214

*These bridges have glass passivated chip junctions

In-Line Single Phase Bridge Rectifiers 1.0 to 8.0 AMPERES

Types:

KBP005M thru KBP10M*
 2KBP005M thru 2KBP10M*
 KBU4A thru KBU4M
 KBL005 thru KBL10
 KBU6A thru KBU6M
 KBU8A thru KBU8M
 B40C3700 2200 thru B380C3700 2200
 B40C5000 3300 thru B380C5000 3300
 3N249 thru 3N252*
 3N253 thru 3N259*

Features:

- ◆ Surge Overload Rating from 50 to 300 Amperes Peak
- ◆ Ideal for Printed Circuit Board
- ◆ Reliable Low Cost Construction utilizing molded Plastic
- ◆ Leads are Solderable to MIL-STD-202 Method 208
- ◆ Plastic Package has Underwriters Laboratory Flammability Classification 94V-0
- ◆ All bridge series are UL recognized under component index file number E54214

*These series have Glass Passivated Chip Junctions

High Current Single Phase Bridge Rectifiers 3.0 to 35 AMPERES

Types:

KBPC1005 thru KBPC110
 SUPERRECTIFIER
 Construction
 KBPC6005 thru KBPC610
 KBPC8005 thru KBPC810
 SUPERRECTIFIER
 Construction
 KBPC10-005 thru KBPC10 -10
 KBPC15-005 thru KBPC15 -10
 KBPC25-005 thru KBPC25 -10
 KBPC35-005 thru KBPC35 -10

Features:

- ◆ High Capability of Surge Overload Rating
- ◆ Insulated Case for Maximum Heat Dissipation
- ◆ Low Forward Voltage Drop
- ◆ Copper Leads or Faston Terminals
- ◆ Simple Installation thru Screw hole for NBR6 Screw
- ◆ Leads or Terminals are Solderable to MIL-STD-202 Method 208
- ◆ Plastic Package has Underwriters Laboratory Flammability Classification 94V-0
- ◆ All bridge series are UL recognized under component index, file number E54214

**GENERAL
INSTRUMENT**

QUICK GUIDE TO BRIDGE RECTIFIERS

I_o (A)	1.0	1.5	1.5	1.0	2.0	2.0	2.0	4.0	4.0	6.0	8.0	I_o (A)
@ T_a (°C)	40	25	50	75	25	50	55	50	65	40	100T _C	@ T_a (°C)
SURGE (A)	50	50	50	30	60	60	60	200	200	250	300	SURGE (A)
$V_{ri} = 50$ (V)	DF005M	W005M IG	KBP005M	3N246	2W005M	2KBP005M	3N253	KBL005	KBU4A	KBU6A	KBU8A	$V_{ri} = 50$ (V)
$V_{ri} = 100$ (V)	DF01M	W01M IG	KBP01M	3N247	2W01M	2KBP01M	3N254	KBL01	KBU4B	KBU6B	KBU8B	$V_{ri} = 100$ (V)
$V_{ri} = 200$ (V)	DF02M	W02M IG	KBP02M	3N248	2W02M	2KBP02M	3N255	KBL02	KBU4D	KBU6D	KBU8D	$V_{ri} = 200$ (V)
$V_{ri} = 400$ (V)	DF04M	W04M IG	KBP04M	3N249	2W04M	2KBP04M	3N256	KBL04	KBU4G	KBU6G	KBU8G	$V_{ri} = 400$ (V)
$V_{ri} = 600$ (V)	DF06M	W06M IG	KBP06M	3N250	2W06M	2KBP06M	3N257	KBL06	KBU4J	KBU6J	KBU8J	$V_{ri} = 600$ (V)
$V_{ri} = 800$ (V)	DF08M	W08M IG	KBP08M	3N251	2W08M	2KBP08M	3N258	KBL08	KBU4K	KBU6K	KBU8K	$V_{ri} = 800$ (V)
$V_{ri} = 1000$ (V)	DF10M	W10M IG	KBP10M	3N252	2W10M	2KBP10M	3N259	KBL10	KBU4M	KBU6M	KBU8M	$V_{ri} = 1000$ (V)

QUICK GUIDE TO BRIDGE RECTIFIERS

I_o (A)	3.0	6.0	8.0	10	15	25	35	I_o (A)
@ T_a (°C)	50	100	50	55	55	55	55	@ T_a (°C)
SURGE (A)	50	200	125	200	300	300	400	SURGE (A)
$V_{ri} = 50$ (V)	KBPC1005■	KBPC6005	KBPC8005■	KBPC10-005	KBPC15-005	KBPC25-005	KBPC35-005	$V_{ri} = 50$ (V)
$V_{ri} = 100$ (V)	KBPC101■	KBPC601	KBPC801■	KBPC10-01	KBPC15-01	KBPC25-01	KBPC35-01	$V_{ri} = 100$ (V)
$V_{ri} = 200$ (V)	KBPC102■	KBPC602	KBPC802■	KBPC10-02	KBPC15-02	KBPC25-02	KBPC35-02	$V_{ri} = 200$ (V)
$V_{ri} = 400$ (V)	KBPC104■	KBPC604	KBPC804■	KBPC10-04	KBPC15-04	KBPC25-04	KBPC35-04	$V_{ri} = 400$ (V)
$V_{ri} = 600$ (V)	KBPC106■	KBPC606	KBPC806■	KBPC10-06	KBPC15-06	KBPC25-06	KBPC35-06	$V_{ri} = 600$ (V)
$V_{ri} = 800$ (V)	KBPC108■	KBPC608	KBPC808■	KBPC10-08	KBPC15-08	KBPC25-08	KBPC35-08	$V_{ri} = 800$ (V)
$V_{ri} = 1000$ (V)	KBPC110■	KBPC610	KBPC810■	KBPC10-10	KBPC15-10	KBPC25-10	KBPC35-10	$V_{ri} = 1000$ (V)

■ SUPERECTIFIER construction

QUICK GUIDE TO BRIDGE RECTIFIERS

I_o (A)	0.8	1.0	1.5	1.5	3.7	5.0	I_o (A)
@ T_a (°C)	45	45	45	45	45	45	@ T_a (°C)
SURGE (A)	45	45	45	90	100	200	SURGE (A)
$V_{RMS} = 40$ (V)	B40C800 ¹⁾²⁾	B40C1000 ¹⁾	B40C1500	B40C1500 C	B40C3700/2200	B40C5000/3300	$V_{RMS} = 40$ (V)
$V_{RMS} = 80$ (V)	B80C800 ¹⁾²⁾	B80C1000 ¹⁾	B80C1500	B80C1500 C	B80C3700/2200	B80C5000/3300	$V_{RMS} = 80$ (V)
$V_{RMS} = 125$ (V)	B125C800 ¹⁾²⁾	B125C1000 ¹⁾	B125C1500	B125C1500 C	B125C3700/2200	B125C5000/3300	$V_{RMS} = 125$ (V)
$V_{RMS} = 250$ (V)	B250C800 ¹⁾²⁾	B250C1000 ¹⁾	B250C1500	B250C1500 C	B250C3700/2200	B250C5000/3300	$V_{RMS} = 250$ (V)
$V_{RMS} = 380$ (V)	B380C800 ¹⁾²⁾	B380C1000 ¹⁾	B380C1500	B380C1500 C	B380C3700/2200	B380C5000/3300	$V_{RMS} = 380$ (V)

1) M Indicates Miniature Package

2) DM Indicates Dual-Inline Package (IC-Leads)

**GENERAL
INSTRUMENT**

B40C / B80C / B125C / B250C / B380C 800M SERIES

MINIATURE SINGLE - PHASE SILICON BRIDGE RECTIFIER

Voltage - 65 to 600 Volts **Current** - 0.9 Amperes

FEATURES

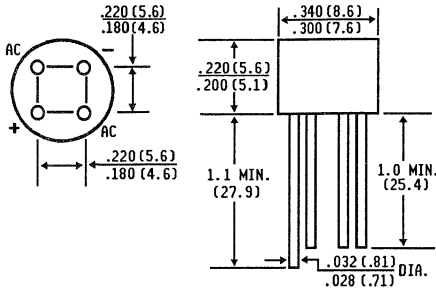

Dimensions in inches
and
(millimeters)

- ◆ Plastic package has Underwriters Laboratory Flammability Classification 94V-0
- ◆ High case dielectric strength
- ◆ Typical I_R less than $0.1 \mu A$
- ◆ High overload surge current
- ◆ Ideal for printed circuit board
- ◆ High temperature soldering guaranteed
250°C/10 seconds/.375", (9.5mm) lead length at 5 lbs., (2.3kg) tension

MECHANICAL DATA

Case: Reliable low cost construction utilizing

molded plastic technique

Terminals: Plated Leads solderable per

MIL-STD-202, Method 208

Mounting Position: Any

Weight: 0.05 ounce, 1.3 gram

MAXIMUM RATINGS AND ELECTRICAL CHARACTERISTICS

Ratings at 25°C ambient temperature unless otherwise specified. 50 Hz or 60 Hz, resistive or inductive load.

	SYMBOLS	B40	B80	B125	B250	B380	UNITS
Maximum Recurrent Peak Reverse Voltage	V_{RRM}	65	125	200	400	600	Volts
Maximum RMS Input Voltage R + C-Load	V_{RMS}	40	80	125	250	380	Volts
Maximum Average Forward Output Current for free air operation at $T_A = 45^\circ C$	$I_{(AV)}$	0.9					Amps
R + L-Load C - Load		0.8					
Maximum DC Blocking Voltage	V_{DC}	65	125	200	400	600	Volts
Maximum Repetitive Peak Reverse Voltage	V_{RRM}	65	125	200	400	600	Volts
Maximum Peak Working Voltage	V_{RWM}	90	180	300	600	900	Volts
Maximum Non-Repetitive Peak Voltage	V_{RSM}	100	200	350	600	1000	Volts
Maximum Repetive Peak Forward Surge Current	I_{FRM}	10.0					Amps
Peak Forward Surge Current							
Single Sine wave on rated load at $T_J = 125^\circ C$	I_{FSM}	45.0					Amps
Rating for Fusing at $T_J = 125^\circ C$ ($t < 100ms$)	$I^2 t$	10.0					A ² S
Minimum Series Resistor C-Load $V_{RMS} = + 10\%$	R_t	1.0	2.0	4.0	8.0	12.0	ohms
Maximum Load Capacitance	C_L	5000	2500	1000	500	200	μF
Maximum Instantaneous Forward Voltage Drop per element at 0.9A	V_F	1.0					Volts
Maximum Reverse Current at rated Repetitive Peak Voltage per element $T_A = 25^\circ C$	I_R	10.0					μA
Typical Thermal Resistance (Note 1)	$R_{\theta JA}$	36.0					°C/W
Operating Temperature Range	T_J	-40 to +125					°C
Storage Temperature Range	T_{STG}	-40 to +150					°C

NOTES:

1. Thermal Resistance from Junction to Ambient mounted on P.C Board at .375" (9.5mm) Lead Lengths with 0.2" x 0.2" (5.5mm and 5.5mm) Copper Pads.

RATINGS AND CHARACTERISTIC CURVES B40C THRU B380C 800M

FIG. 1 - DERATING CURVE FOR OUTPUT RECTIFIED CURRENT FOR B40C 800M...B125C 800M

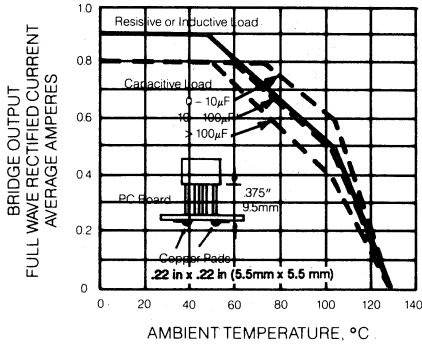

FIG. 2 - DERATING CURVES FOR OUTPUT RECTIFIED CURRENT B250C 800M...B380C 800M

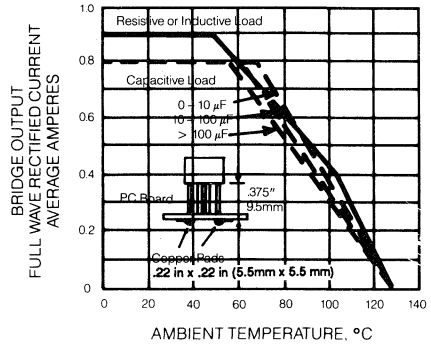

FIG. 3 - TYPICAL REVERSE CHARACTERISTICS

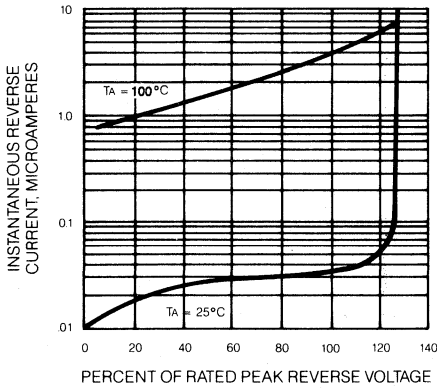

FIG. 4 - TYPICAL FORWARD CHARACTERISTICS

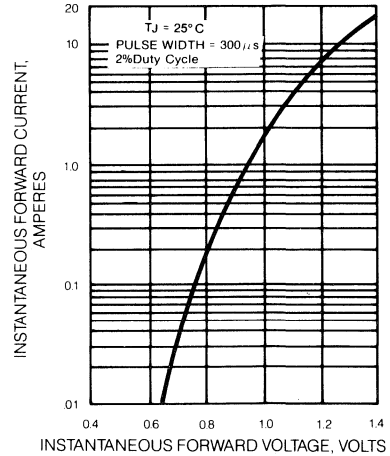

FIG. 5 - MAXIMUM NON-REPETITIVE PEAK FORWARD CURRENT

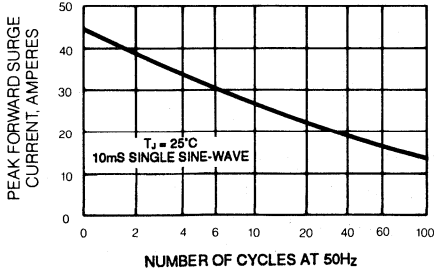
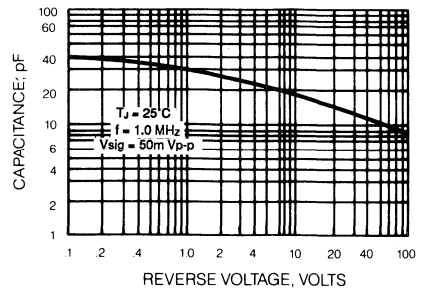

FIG. 6 - TYPICAL JUNCTION CAPACITANCE PER BRIDGE ELEMENT



B40C / B80C / B125C / B250C / B380C 800 DM SERIES

MINIATURE GLASS PASSIVATED SINGLE - PHASE BRIDGE RECTIFIER
Voltage - 65 to 600 Volts Current - 0.9 Amperes

FEATURES

- ◆ Plastic package has Underwriters Laboratory Flammability Classification 94V-0
- ◆ Glass passivated chip junctions
- ◆ Surge overload rating of 45 Amperes peak
- ◆ Ideal for printed circuit board
- ◆ High temperature soldering guaranteed 265°C / 10 seconds at 5 lbs., (2.3kg) tension

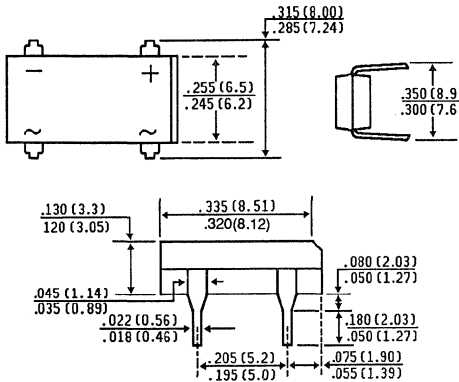

Dimensions in inches and (millimeters)

MECHANICAL DATA

Case: Reliable low cost construction utilizing molded plastic technique

Terminals: Plated Leads solderable per MIL-STD-202, Method 208

Mounting Position: Any

Weight: 0.04 ounce, 1.0 gram

MAXIMUM RATINGS AND ELECTRICAL CHARACTERISTICS

Ratings at 25°C ambient temperature unless otherwise specified. 50 Hz or 60 Hz, resistive or inductive load.

	SYMBOLS	B40	B80	B125	B250	B380	UNITS
Maximum Recurrent Peak Reverse Voltage	V_{RRM}	65	125	200	400	600	Volts
Maximum RMS Input Voltage R + C-Load	V_{RMS}	40	80	125	250	380	Volts
Maximum Average Forward Output Current for free air operation at $T_A = 45^\circ\text{C}$	$I_{(AV)}$	0.9					Amps
R + L-Load		0.8					
Maximum DC Blocking Voltage	V_{DC}	65	125	200	400	600	Volts
Maximum Repetitive Peak Reverse Voltage	V_{RRM}	90	180	300	600	900	Volts
Maximum Peak Working Voltage	V_{RWM}	90	180	300	600	900	Volts
Maximum Non-Repetitive Peak Voltage	V_{RSM}	100	200	350	650	1000	Volts
Maximum Repetive Peak Forward Surge Current	I_{FRM}	10.0					Amps
Peak Forward Surge Current							
Single Sine wave on rated load at $T_J = 125^\circ\text{C}$	I_{FSM}	45.0					Amps
Rating for Fusing at $T_J = 125^\circ\text{C}$ ($t < 100\text{ms}$)	I^2t	10.0					A ² S
Minimum Series Resistor C-Load $V_{RMS} = +10\%$	R_t	1.0	2.0	4.0	8.0	12.0	ohms
Maximum Load Capacitance +50%							
-10%	CL	5000	2500	1000	500	200	μF
Maximum Instantaneous Forward Voltage Drop per element at 0.9A	V_F	1.0					Volts
Maximum Reverse Current at rated Repetitive Peak Voltage per element $T_A = 25^\circ\text{C}$	I_R	10.0					μA
Typical Thermal Resistance (Note 1)	$R_{\theta JA}$	40.0					$^\circ\text{C}/\text{W}$
Operating Temperature Range	T_J	-40 to +125					$^\circ\text{C}$
Storage Temperature Range	T_{STG}	-40 to +150					$^\circ\text{C}$

NOTES:

1. Thermal Resistance from Junction to Ambient mounted on P.C Board 0.5" x 0.5" (13mm x 13mm) Copper pads.

RATINGS AND CHARACTERISTIC CURVES B40C THRU B380C 800 DM

FIG 1 - DERATING CURVE FOR OUTPUT RECTIFIED CURRENT FOR B40C 1000M...B125C 1000M

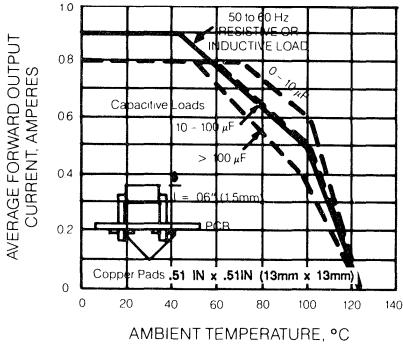

FIG.2 - DERATING CURVE FOR OUTPUT RECTIFIED CURRENT FOR B250C 1000M...B380C 1000M

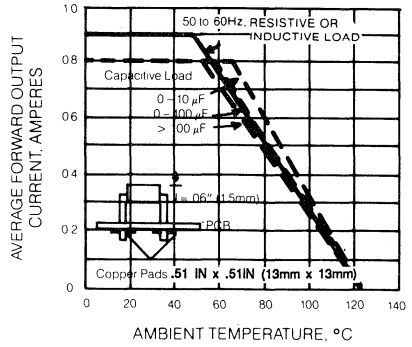

FIG. 3 — MAXIMUM NON-REPETITIVE PEAK FORWARD SURGE CURRENT

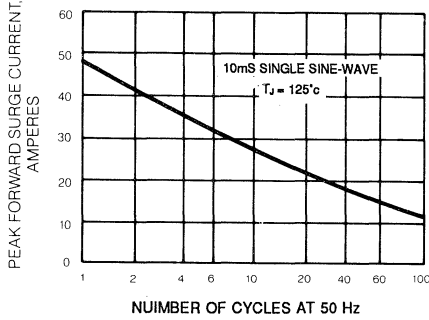

FIG. 4 — TYPICAL FORWARD CHARACTERISTICS PER BRIDGE ELEMENT

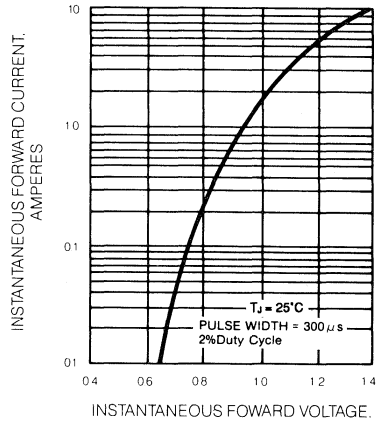

FIG. 5 — TYPICAL JUNCTION CAPACITANCE PER BRIDGE ELEMENT

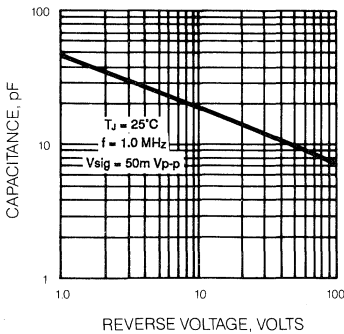
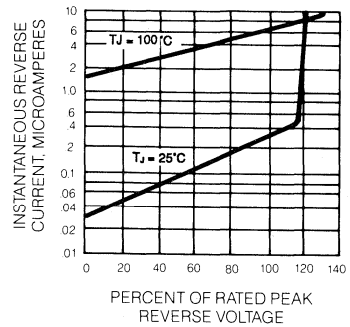

FIG. 6 — TYPICAL REVERSE CHARACTERISTICS



DF005M THRU DF10M

MINIATURE GLASS PASSIVATED SINGLE - PHASE SILICON BRIDGE RECTIFIER VOLTAGE - 50 to 1000 Volts CURRENT - 1.0 Ampere

FEATURES

- ◆ This series is UL recognized under component index, file number E54214
- ◆ Plastic material used carries Underwriters Laboratory flammability recognition 94V-O
- ◆ Glass passivated chip junctions
Surge overload rating of 50 Amperes peak
- ◆ Ideal for printed circuit board
- ◆ High temperature soldering guaranteed:
265° C /10 seconds at 5 lbs., (2.3kg) tension

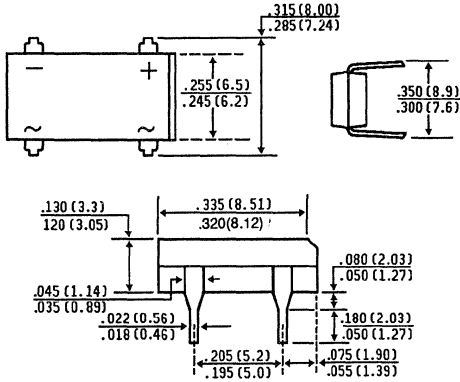

Dimensions in inches
and
(millimeters)

MECHANICAL DATA

Case: Reliable low cost construction utilizing molded plastic technique

Terminals: Plated Lead solderable per MIL-STD-202, Method 208

Polarity: Polarity symbols marked on body

Weight: 0.04 ounce, 1.0 gram

Mounting Position: Any

MAXIMUM RATINGS AND ELECTRICAL CHARACTERISTICS

Ratings at 25°C ambient temperature unless otherwise specified
60 Hz, resistive or inductive load.

	SYMBOLS	DF 005M	DF 01M	DF 02M	DF 04M	DF 06M	DF 08M	DF 10M	UNITS
Maximum Recurrent Peak Reverse Voltage	V _{RRM}	50	100	200	400	600	800	1000	Volts
Maximum RMS Voltage	V _{RMS}	35	70	140	280	420	560	700	Volts
Maximum DC Blocking Voltage	V _{DC}	50	100	200	400	600	800	1000	Volts
Maximum Average Forward Output Rectified Current at T _A = 40°C	I _(AV)	1.0							Amps
Peak Forward Surge Current Single sine-wave superimposed on rated load (JEDEC Method)	I _{FSM}	50.0							Amps
Rating for fusing (t < 8.35ms)	I ² t	10.0							A ² s
Maximum Instantaneous Forward Voltage drop per element at 1.0A	V _F	1.1							Volts
Maximum Reverse Current at Rated DC Blocking Voltage per element T _A = 25°C T _A = 125°C	I _R	10.0 500							μA
Typical Junction Capacitance per element (Note 1)	C _J	25.0							pf
Typical Thermal Resistance (Note 2)	R _{ΘJA}	40.0							°C/W
Operating and Storage Temperature Range,	T _J , T _{STG}	-55 to +150							°C

NOTES:

1. Measured at 1.0 MHz and applied reverse voltage of 4.0 Volts.
2. Thermal Resistance from Junction to Ambient mounted on P.C. Board with 0.5" x 0.5" (13mm x 13mm) Copper Pads.

RATINGS AND CHARACTERISTIC CURVES DF005M THRU DF10M

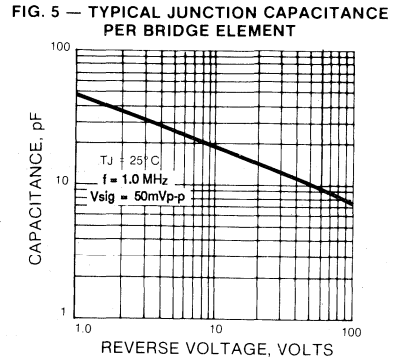
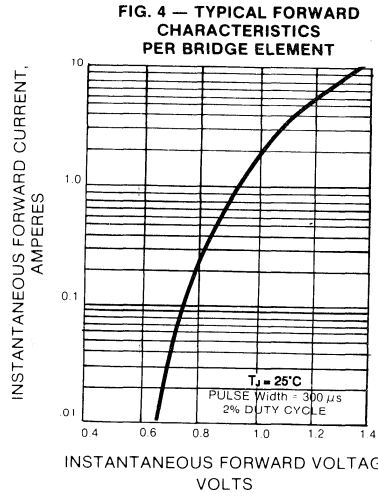
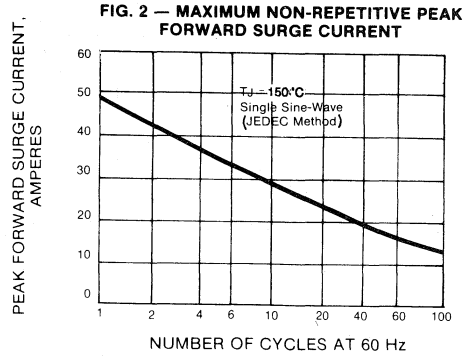
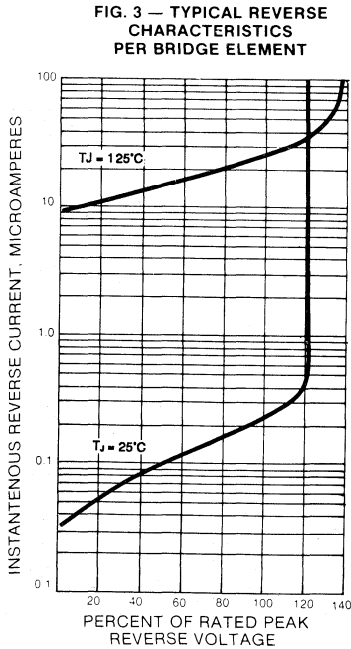
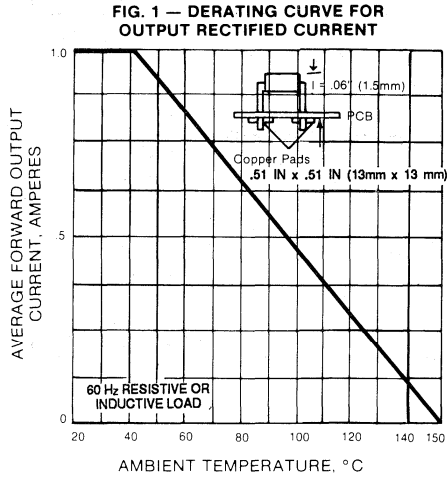

B40C / B80C / B125C / B250C / B380C 1000M

MINIATURE SINGLE - PHASE SILICON BRIDGE RECTIFIER
Voltage - 65 to 600 Volts Current - 1.0 Ampere

FEATURES

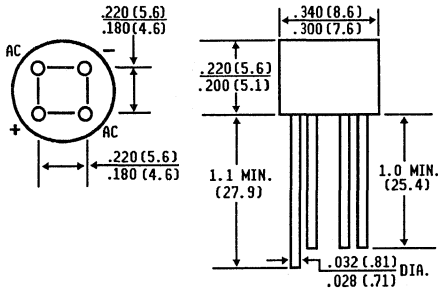

Dimensions in inches
and
(millimeters)

- ◆ Plastic package has Underwriters Laboratory Flammability Classification 94V-0
- ◆ High case dielectric strength
- ◆ Typical I_R less than $0.1 \mu A$
- ◆ High overload surge current
- ◆ Ideal for printed circuit board
- ◆ High temperature soldering guaranteed $250^\circ C/10$ seconds/.375", (9.5mm) lead length at 5 lbs., (2.3kg) tension

MECHANICAL DATA

Case: Reliable low cost construction utilizing molded plastic technique

Terminals: Plated Leads solderable per MIL-STD-202, Method 208

Mounting Position: Any

Weight: 0.05 ounce, 1.3 gram

MAXIMUM RATINGS AND ELECTRICAL CHARACTERISTICS

Ratings at $25^\circ C$ ambient temperature unless otherwise specified. 50Hz or 60 Hz, resistive or inductive load.

	SYMBOLS	B40	B80	B125	B250	B380	UNITS
Maximum Recurrent Peak Reverse Voltage	V_{RRM}	65	125	200	400	600	Volts
Maximum RMS Input Voltage R + C-Load	V_{RMS}	40	80	125	250	380	Volts
Maximum Average Forward Output Current for free air operation at $T_A = 45^\circ C$ R + L-Load C - Load	$I_{(AV)}$	1.2 1.0					Amps
Maximum DC Blocking Voltage	V_{DC}	65	125	200	400	600	Volts
Maximum Repetitive Peak Reverse Voltage	V_{RRM}	90	180	300	600	800	Volts
Maximum Peak Working Voltage	V_{RWM}	90	180	300	600	900	Volts
Maximum Non-Repetitive Peak Voltage	V_{RSM}	100	200	350	600	1000	Volts
Maximum Repetive Peak Forward Surge Current	I_{FRM}	10.0					Amps
Peak Forward Surge Current Single Sine wave on rated load (JEDEC) Method) at $T_J = 125^\circ C$	I_{FSM}	45.0					Amps
Rating for Fusing at $T_J = 125^\circ C$ ($t < 100ms$)	I^2t	10.0					A^2S
Minimum Series Resistor C-Load $V_{RMS} = -or+ 10\%$	R_{TW}	1.0	2.0	4.0	8.0	12.0	ohms
Maximum Load Capacitance +50% -10%	C_L	5000	2500	1000	500	200	μF
Maximum Instantaneous Forward Voltage Drop per element at 1.0A	V_F	1.0					Volts
Maximum Reverse Current at rated Repetitive Peak Voltage per element $T_A = 25^\circ C$	I_R	10.0					μA
Typical Thermal Resistance (Note 1)	$R_{\theta JA}$	36.0					$^\circ C/W$
Operating Temperature Range	T_J	-40 to +125					$^\circ C$
Storage Temperature Range	T_{STG}	-40 to +150					$^\circ C$

NOTES:

1. Thermal Resistance from Junction to Ambient mounted on P.C Board at .375" (9.5mm) Lead Lengths with 0.2" x 0.2" (5.5mm x 5.5mm) Copper Pads..

RATINGS AND CHARACTERISTIC CURVES B40C 1000 THRU B380C 1000M

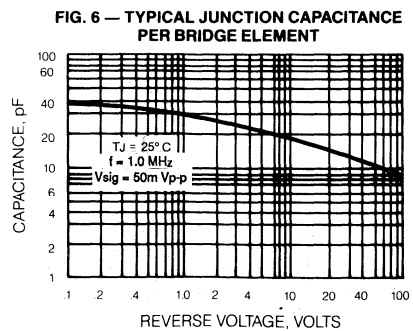
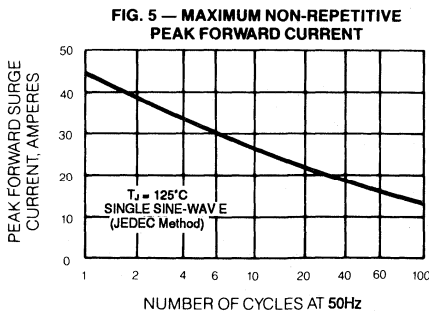
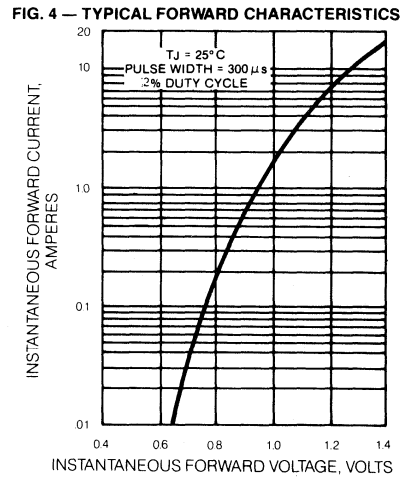
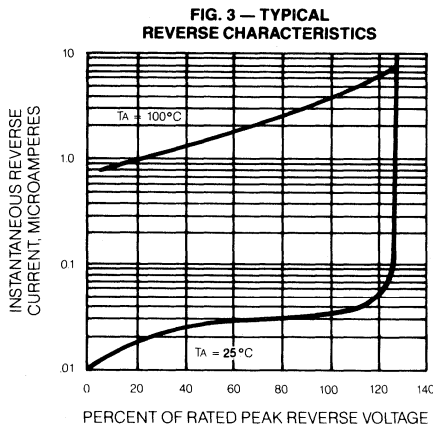
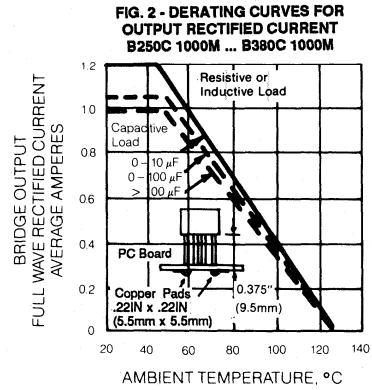
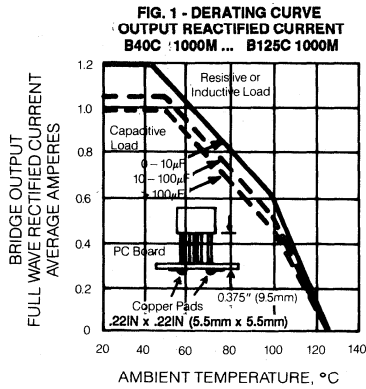

**GENERAL
INSTRUMENT**

W005M THRU W10M

MINIATURE SINGLE - PHASE SILICON BRIDGE RECTIFIER
VOLTAGE - 50 to 1000 Volts CURRENT - 1.5 Amperes

FEATURES

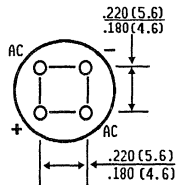
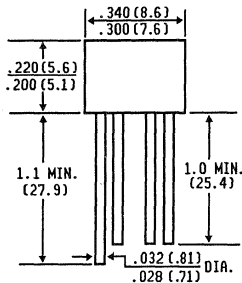

Dimensions in inches
and
(millimeters)

- ◆ This series is UL recognized under component index, file number E54214
- ◆ Plastic material used carries Underwriters Laboratory flammability recognition 94V-O
- ◆ High case dielectric strength
- ◆ Typical IR less than 0.1 μ A
- ◆ High overload surge capability
- ◆ Ideal for printed circuit board
- ◆ High temperature soldering guaranteed:
250° C / 10 seconds / .375", (9.5mm) lead length / 5lbs., (2.3 kg) tension

MECHANICAL DATA

Case: Reliable low cost construction utilizing molded plastic technique

Terminals: Plated Leads solderable per MIL-STD-202, Method 208

Weight: 0.05 ounce, 1.3 grams

Mounting Position: Any

MAXIMUM RATINGS AND ELECTRICAL CHARACTERISTICS

Ratings at 25°C ambient temperature unless otherwise specified.
60 Hz, resistive or inductive load.

	SYMBOLS	W 005M	W 01M	W 02M	W 04M	W 06M	W 08M	W 10M	UNITS
Maximum Recurrent Peak Reverse Voltage	V _{RRM}	50	100	200	400	600	800	1000	Volts
Maximum RMS Voltage	V _{RMS}	35	70	140	280	420	560	700	Volts
Maximum DC Blocking Voltage	V _{DC}	50	100	200	400	600	800	1000	Volts
Maximum Average Forward Rectified Current at .375", (9.5mm) lead length at T _A = 25°C	I _(AV)	1.5							Amps
Peak Forward Surge Current Single sine-wave superimposed on rated load (JEDEC Method)	I _{FSM}	50.0							Amps
Rating for fusing (t < 8.3ms)	I ² t	10.0							A ² s
Maximum Instantaneous Forward Voltage drop per element at 1.0A	V _F	1.0							Volts
Maximum DC Reverse Current at Rated DC Blocking Voltage	I _R	10.0							μ A
		1.0							mA
Typical Junction Capacitance per element (Note 1)	C _J	24.0							pf
Typical Thermal Resistance (Note 2)	R θ JA	36.0							°C/W
Operating Temperature Range	T _J	-50 to +125							°C
Storage Temperature Range,	T _{STG}	-50 to +150							°C

NOTES:

1. Measured at 1.0 MHz and applied reverse voltage of 4.0 Volts.
2. Thermal Resistance from Junction to Ambient at .375", (9.5mm) lead lengths mounted on P.C. Board with, .2" x .2" (5.5 mm x 5.5 mm) Copper Pads.

RATINGS AND CHARACTERISTIC CURVES W005M THRU W10M

**FIG. 1 — DERATING CURVE
OUTPUT RECTIFIED CURRENT**

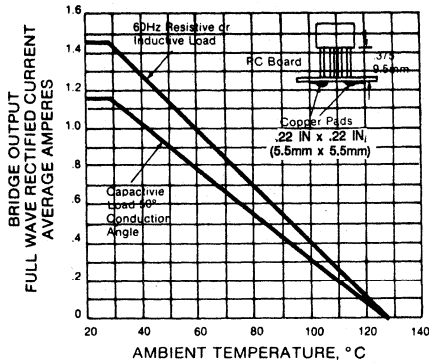

**FIG. 3 - TYPICAL FORWARD
CHARACTERISTICS PER BRIDGE ELEMENT**

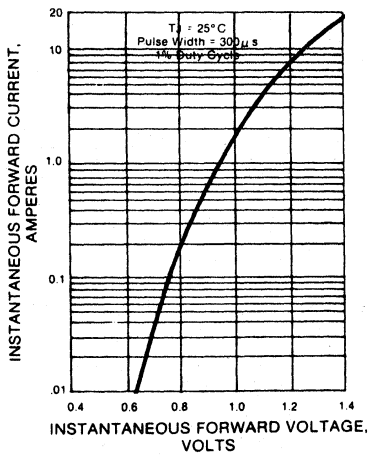

**FIG. 2 — MAXIMUM NON-REPETITIVE
PEAK FORWARD SURGE CURRENT**

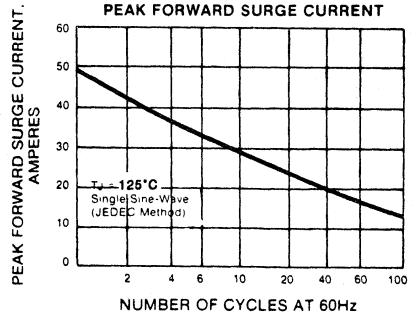

**FIG. 4 — TYPICAL
REVERSE CHARACTERISTICS**

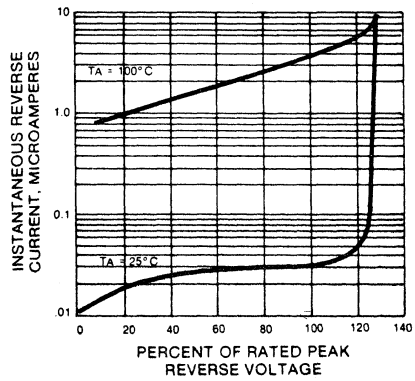

**FIG. 5 — TYPICAL JUNCTION CAPACITANCE
PER BRIDGE ELEMENT**

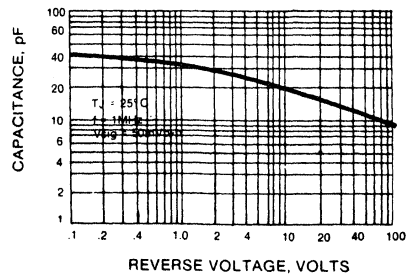

W005G THRU W10G

MINIATURE GLASS PASSIVATED SINGLE-PHASE SILICON BRIDGE RECTIFIER
VOLTAGE - 50 to 1000 Volts CURRENT - 1.5 Amperes

FEATURES

- ◆ Glass passivated chip junctions
- ◆ Plastic material used carries Underwriters Laboratory flammability recognition 94V-O
- ◆ High case dielectric strength
- ◆ Typical I_R less than $0.1 \mu A$
- ◆ High overload surge capability
- ◆ Ideal for printed circuit board
- ◆ High temperature soldering guaranteed:
 $265^\circ C / 10$ seconds / $.375"$, (9.5mm) lead length / 5lbs., (2.3 kg) tension

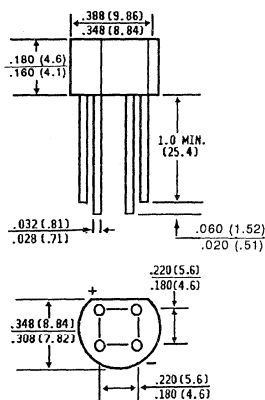

Dimensions in inches
and
millimeters

MECHANICAL DATA

Case: Molded plastic

Terminals: Leads solderable per MIL-STD-202, Method 208

Weight: 0.04 ounce, 1.1 grams

Mounting Position: Any

Weight: 0.04 ounce, 1.1 grams

MAXIMUM RATINGS AND ELECTRICAL CHARACTERISTICS

Ratings at $25^\circ C$ ambient temperature unless otherwise specified.
 60 Hz, resistive or inductive load.

	SYMBOLS	W 005G	W 01G	W 02G	W 04G	W 06G	W 08G	W 10G	UNITS
Maximum Recurrent Peak Reverse Voltage	V_{RRM}	50	100	200	400	600	800	1000	Volts
Maximum RMS Voltage	V_{RMS}	35	70	140	280	420	560	700	Volts
Maximum DC Blocking Voltage	V_{DC}	50	100	200	400	600	800	1000	Volts
Maximum Average Forward Rectified Current at .375", (9.5mm) lead length at $T_A = 25^\circ C$	$I_{(AV)}$	1.5							Amps
Peak Forward Surge Current Single half sine-wave superimposed on rated load (JEDEC Method)	I_{FSM}	50.0							Amps
Rating for fusing ($t < 8.3ms$)	I^2t	10.0							A^2s
Maximum Instantaneous Forward Voltage Drop per element at 1.0 Amperes	V_F	1.0							Volts
Maximum DC Reverse Current at Rated $T_A = 25^\circ C$ DC Blocking Voltage per Bridge Element $T_A = 125^\circ C$	I_R	500							μA
Typical Junction Capacitance per element (Note 1)	C_J	14.0							pf
Typical Thermal Resistance (Note 2)	$R_{\theta JA}$	36.0							$^\circ C/W$
Operating Temperature Range	T_A	-55 to +150			-55 to +125				$^\circ C$
Storage Temperature Range	T_{STG}	-55 to +150							$^\circ C$

NOTES:

1. Measured at 1.0 MHz and applied reverse voltage of 4.0 Volts.
2. Thermal Resistance from Junction to Ambient at $.375"$, 9.5mm lead length P.C. Board mounting.

RATINGS AND CHARACTERISTIC CURVES W005G THRU W10G

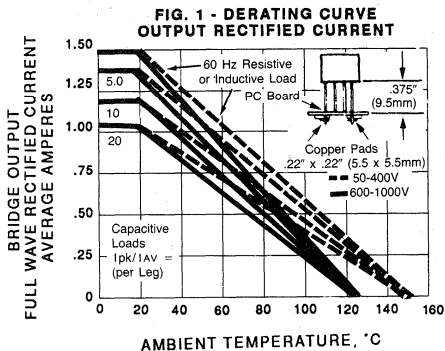

FIG. 3 - TYPICAL REVERSE CHARACTERISTICS

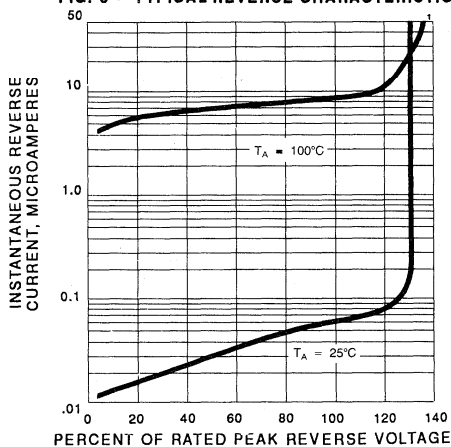

FIG. 5 - TYPICAL JUNCTION CAPACITANCE PER BRIDGE ELEMENT

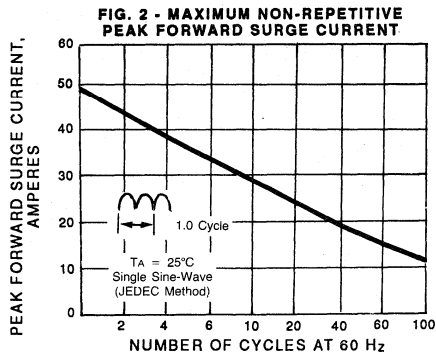
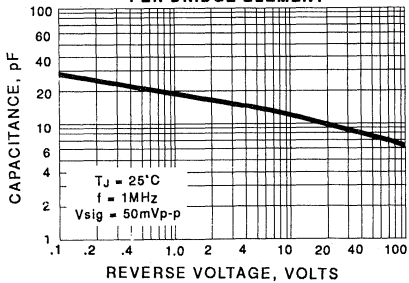

FIG. 4 - TYPICAL FORWARD CHARACTERISTICS PER ELEMENT

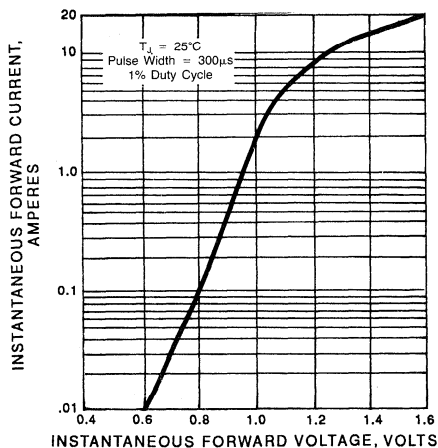
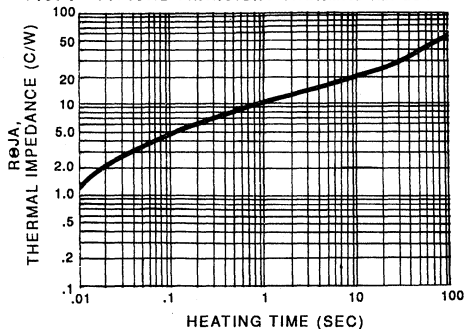

FIG. 6 - TYPICAL TRANSIENT THERMAL IMPEDANCE



KBP005M THRU KBP10M 3N246 THRU 3N252

**MINIATURE GLASS PASSIVATED
SINGLE - PHASE SILICON BRIDGE**
VOLTAGE - 50 to 1000 Volts CURRENT - 1.5 Amperes

FEATURES

- ◆ This series is UL recognized under component index, file number E54214
- ◆ Plastic material used carries Underwriters Laboratory flammability recognition 94V-0
- ◆ Glass passivated chip junctions
- ◆ Surge overload rating - 30 Amperes peak
- ◆ Ideal for printed circuit board
- ◆ High temperature soldering guaranteed : 265° C /10 seconds at 5 lbs., (2.3kg) tension

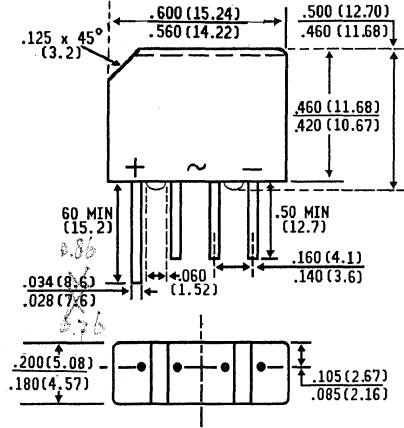
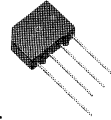

Dimensions in inches
and
(millimeters)

MECHANICAL DATA

Case: Reliable low cost construction utilizing molded plastic technique

Terminals: Plated Lead solderable per MIL-STD-202, Method 208

Polarity: Polarity symbols marked on case

Mounting position: Any

Weight : 0.06 ounce, 1.70 gram

MAXIMUM RATINGS AND ELECTRICAL CHARACTERISTICS

Ratings at 25°C ambient temperature unless otherwise specified.
60 Hz, resistive or inductive load.

	SYMBOLS	KBP005M KBP01M KBP02M KBP04M KBP06M KBP08M KBP10M							UNITS
		3N246	3N247	3N248	3N249	3N250	3N251	3N252	
* Maximum Recurrent Peak Reverse Voltage	V _{RRM}	50	100	200	400	600	800	1000	Volts
* Maximum RMS Voltage	V _{RMS}	35	70	140	280	420	560	700	Volts
* Maximum DC Blocking Voltage	V _{DC}	50	100	200	400	600	800	1000	Volts
Maximum Average Forward Output Rectified Current at T _A = 40°C	I _(AV)	1.5							Amps
* Peak Forward Surge Current Single sine-wave superimposed on rated load (JEDEC Method)	I _{FSM}	30.0							Amps
Rating for fusing (t<8.35ms)	I ² t	10.0							A ² s
* Maximum Instantaneous Forward Voltage drop per Bridge Element at 1.0A 1.57A	V _F	1.0 1.3							Volts
* Maximum DC Reverse Current at Rated DC Blocking Voltage T _A = 25°C T _A = 125°C	I _R	10.0 500							μA
Typical Junction Capacitance per element (Note 1)	C _J	15.0							pf
Typical Thermal Resistance (Note 2)	R _{θJA}	28.0							°C/W
* Operating and Storage Temperature Range	T _J , T _{STG}	-55 to +150							°C

NOTES:

1. Measured at 1.0 MHz and applied reverse voltage of 4.0 Volts.
2. Thermal Resistance from Junction to Ambient mounted on P.C. Board with, .47" x .47" (12mm x12mm) Copper Pads.
* JEDEC Registered Values

**RATINGS AND CHARACTERISTIC CURVES KBP005M THRU KBP10M /
3N246 THRU 3N252**

**FIG. 2 — DERATING CURVE
OUTPUT RECTIFIED CURRENT**

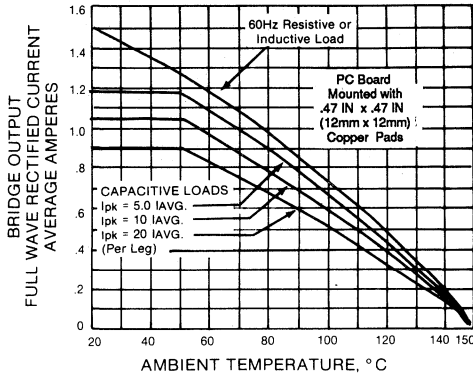

**FIG. 3 — TYPICAL
REVERSE CHARACTERISTICS**

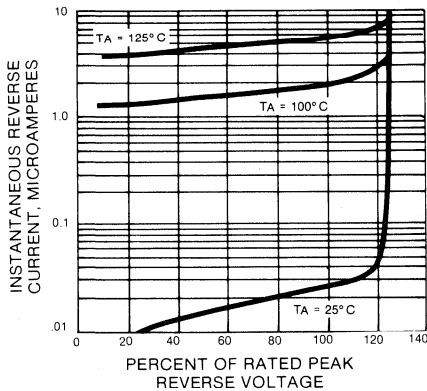

**FIG. 2 — MAXIMUM NON-REPETITIVE
PEAK FORWARD SURGE CURRENT**

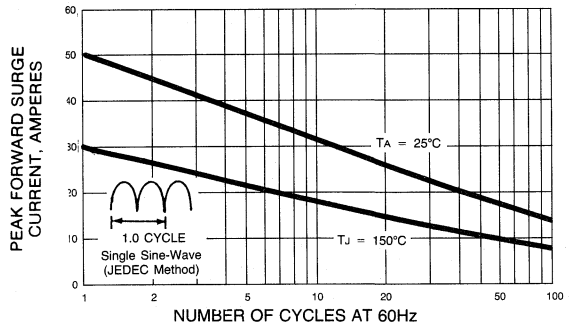

**FIG. 4 — TYPICAL FORWARD
CHARACTERISTICS PER ELEMENT**

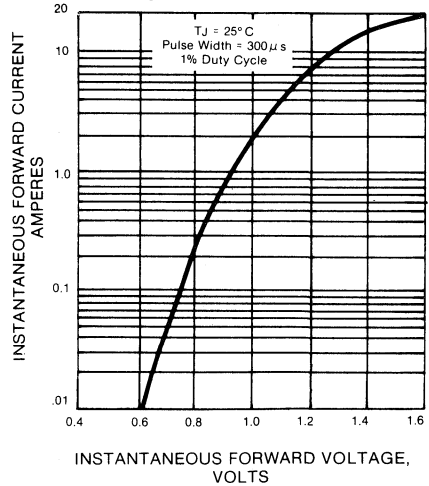

**FIG. 5 — TYPICAL JUNCTION CAPACITANCE
PER BRIDGE ELEMENT**

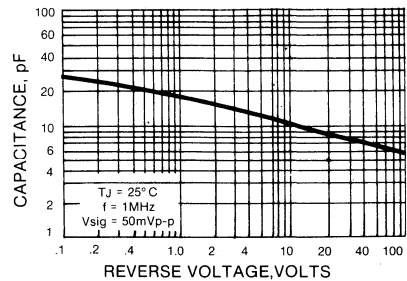

AW02M THRU AW08M

MINIATURE CONTROLLED AVALANCHE SINGLE PHASE SILICON BRIDGE RECTIFIER

VOLTAGE - 200 to 800 Volts **CURRENT - 1.5 Amperes**

FEATURES

- ◆ This series is UL recognized under component index, file number E54214
- ◆ Plastic material used carries Underwriters Laboratory flammability recognition 94V-O
- ◆ High case dielectric strength
- ◆ Typical I_R less than 0.1 μ A
- ◆ High overload surge capability
- ◆ Ideal for printed circuit board
- ◆ Controlled Avalanche Series
- ◆ 200 Watts Avalanche Power Dissipation for 100 μ S pulse width
- ◆ High temperature soldering guaranteed: 250°C/10 seconds/.375", (9.5mm) lead length at 5 lbs., (2.3kg) tension

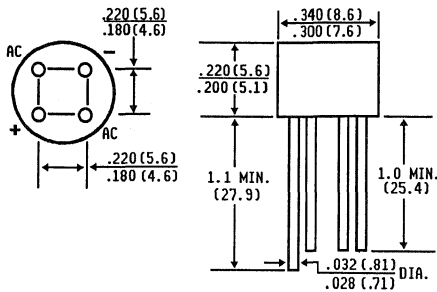

Dimensions in inches
and
(millimeters)

MECHANICAL DATA

Case: Reliable low cost construction utilizing molded plastic technique

Terminals: Plated Leads solderable per MIL-STD-202, Method 208

Mounting Position: Any

Weight: 0.05 ounce, 1.3 grams

MAXIMUM RATINGS AND ELECTRICAL CHARACTERISTICS

Ratings at 25°C ambient temperature unless otherwise specified. 60Hz, resistive or inductive load.. For capacitive load, derate current by 20%

	SYMBOLS	AW02M	AW04M	AW06M	AW08M	UNITS
Maximum Recurrent Peak Reverse Voltage	V_{RRM}	200	400	600	800	Volts
Maximum RMS Voltage	V_{RMS}	140	280	420	560	Volts
Maximum DC Blocking Voltage	V_{DC}	200	400	600	800	Volts
Minimum Avalanche Breakdown Voltage at 100 μ A	V_{BR}	250	450	650	850	Volts
Maximum Avalanche Breakdown Voltage at 100 μ A	V_{BR}	700	900	1100	1300	Volts
Maximum Average Forward Output Current .375" (9.5mm) Lead Length at $T_A = 55^\circ\text{C}$	$I_{(AV)}$	1.5				Amps
Peak Forward Surge Current, Single half sine wave superimposed on rated load (JEDEC Method)	I_{FSM}	50.0				Amps
Rating for fusing ($t < .00835$)	I^2t	10.0				A^2s
Maximum Instantaneous Forward Drop per element at 1.0A	V_F	1.0				Volts
Maximum DC Reverse Current $T_A = 25^\circ\text{C}$ at Rated DC Blocking Voltage $T_A = 100^\circ\text{C}$	I_R	10.0				μ A mA
Typical Junction Capacitance per element (Note 1)	C_J	24.0				pf
Typical Thermal Resistance (Note 2)	$R_{\theta JA}$	36.0				$^\circ\text{C/W}$
Operating Temperature Range	T_J	-50 to +125				$^\circ\text{C}$
Storage Temperature Range	T_{STG}	-50 to +150				$^\circ\text{C}$

- NOTES: 1. Measured at 1.0 MHz and applied reverse voltage of 4.0 Volts.
2. Thermal Resistance from Junction to ambient at .375", (9.5mm) lead lengths mounted on P.C. Board with .2" x .2" (5.5mm x 5.5mm) Copper Pads.

RATINGS AND CHARACTERISTIC CURVES AW02M THRU AW08M

**FIG. 1 — DERATING CURVE
OUTPUT RECTIFIED CURRENT**

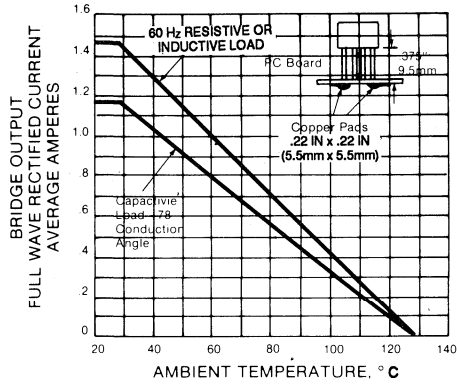

FIG. 3 — TYPICAL FORWARD CHARACTERISTICS PER ELEMENT

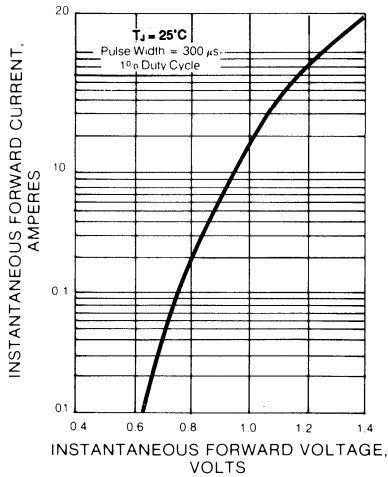

FIG. 2 — MAXIMUM NON-REPETITIVE PEAK FORWARD SURGE CURRENT

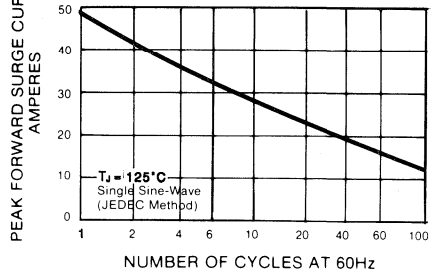

FIG. 4 — TYPICAL REVERSE CHARACTERISTICS

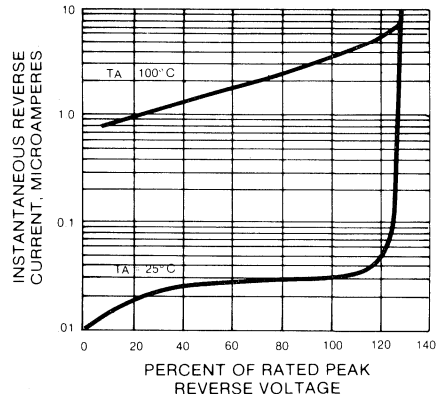
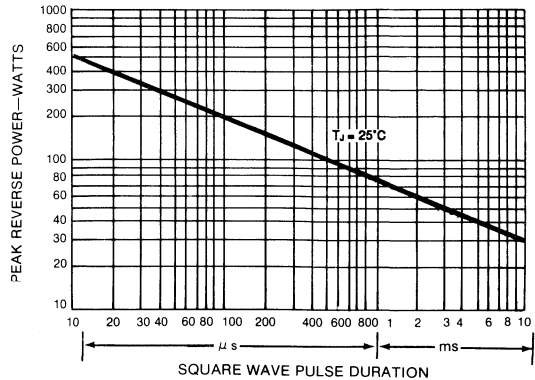

FIG. 5 — MAXIMUM NON-REPETITIVE AVALANCHE SURGE POWER



AW02G THRU AW08G SERIES

MINIATURE GLASS PASSIVATED CONTROLLED AVALANCHE SINGLE - PHASE SILICON BRIDGE RECTIFIER

VOLTAGE - 200 to 800 Volts CURRENT - 1.5 Amperes

FEATURES

- ◆ Glass passivated chip junctions
- ◆ Plastic material used carries Underwriters Laboratory flammability recognition 94V-O
- ◆ High case dielectric strength
- ◆ 200 Watts Avalanche Power Dissipation for 100 μ s
- ◆ Typical I_R less than 0.1 μ A
- ◆ High overload surge capability
- ◆ Ideal for printed circuit board
- ◆ High temperature soldering guaranteed: 265° C/10 seconds / .375", (9.5mm) lead length/5lbs., (2.3 kg) tension

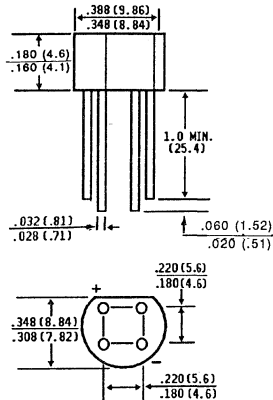
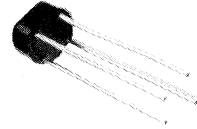

Dimensions in inches
and
(millimeters)

MECHANICAL DATA

Case: Molded plastic

Terminals: Leads solderable per MIL-STD-202, Method 208

Mounting Position: Any

Weight: 0.04 ounce, 1.1 grams

MAXIMUM RATINGS AND ELECTRICAL CHARACTERISTICS

Ratings at 25°C ambient temperature unless otherwise specified.
60 Hz, resistive or inductive load.

	SYMBOLS	AW 02G	AW 04G	AW 06G	AW 08G	UNITS
Maximum Recurrent Peak Reverse Voltage	V_{RRM}	200	400	600	800	Volts
Maximum RMS Voltage	V_{RMS}	140	280	420	560	Volts
Maximum DC Blocking Voltage	V_{DC}	200	400	600	800	Volts
Minimum Avalanche Breakdown Voltage at 100 μ A	V_{BR}	250	450	650	850	Volts
Maximum Avalanche Breakdown Voltage at 100 μ A	V_{BR}	700	900	1100	1300	Volts
Maximum Average Forward Rectified Current at .375", (9.5mm) lead length at $T_A = 25^\circ\text{C}$	$I_{(AV)}$	1.5				Amps
Peak Forward Surge Current Single half sine-wave superimposed on rated load (JEDEC Method)	I_{FSM}	50.0				Amps
Rating for fusing ($t < 8.3\text{ms}$)	I^2t	10.0				A^2s
Maximum Instantaneous Forward Voltage Drop per element at 1.0 Amperes	V_F	1.0				Volts
Maximum DC Reverse Current at Rated $T_A = 25^\circ\text{C}$	I_R	5.0				μA
DC Blocking Voltage per Bridge Element $T_A = 125^\circ\text{C}$		500				
Typical Junction Capacitance per element (Note 1)	C_J	14.0				pf
Typical Thermal Resistance (Note 2)	$R_{\theta JA}$	36.0				$^\circ\text{C/W}$
Operating Temperature Range	T_A	-55 to +150		-55 to +125		$^\circ\text{C}$
Storage Temperature Range	T_{STG}	-55 to +150				$^\circ\text{C}$

NOTES:

1. Measured at 1.0 MHz and applied reverse voltage of 4.0 Volts.
2. Thermal Resistance from Junction to Ambient at .375", 9.5mm lead length P.C. Board mounting.

RATINGS AND CHARACTERISTIC CURVES AW02G THRU AW08G

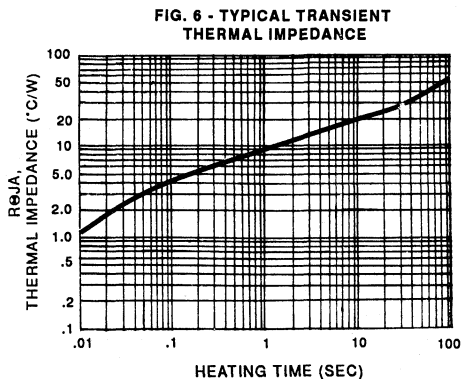
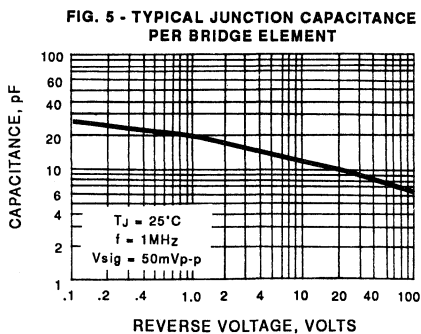
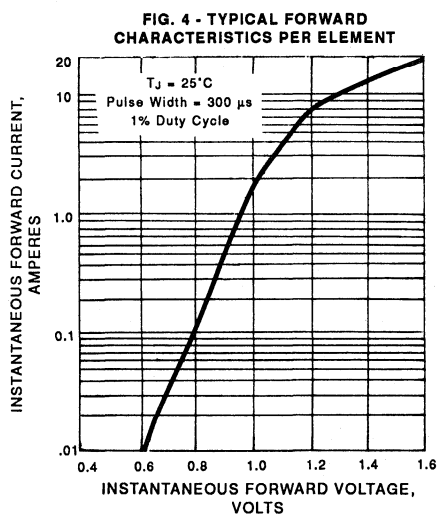
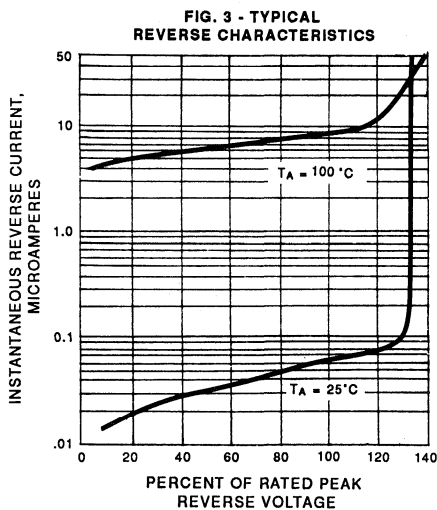
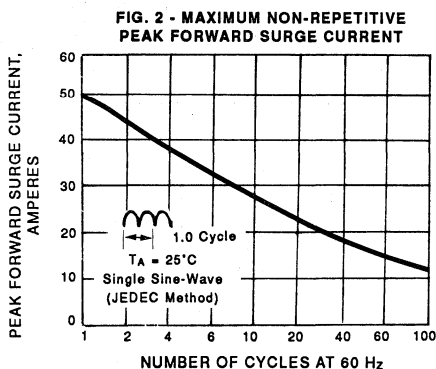
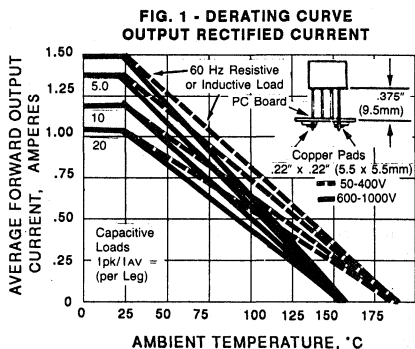

B40C / B80C / B125C / B250C / B380C 1500M SERIES

MINIATURE SINGLE - PHASE SILICON BRIDGE RECTIFIER
Voltage - 65 to 600 Volts Current - 1.5 Amperes

FEATURES

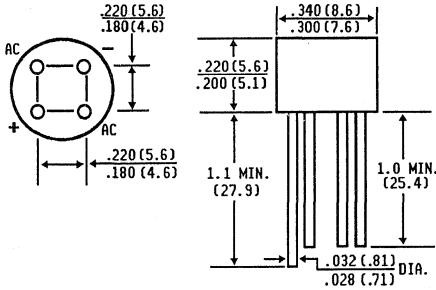

Dimensions in inches
and
(millimeters)

- ◆ Plastic package has Underwriters Laboratory Flammability Classification 94V-0
- ◆ High case dielectric strength
- ◆ Typical I_R less than $0.1 \mu A$
- ◆ High overload surge current
- ◆ Ideal for printed circuit board
- ◆ High temperature soldering guaranteed $250^\circ C/10$ seconds/.375", (9.5mm) lead length at 5 lbs., (2.3kg) tension

MECHANICAL DATA

Case: Reliable low cost construction utilizing molded plastic technique

Terminals: Plated Leads solderable per MIL-STD-202, Method 208

Mounting Position: Any

Weight: 0.05 ounce, 1.3 gram

MAXIMUM RATINGS AND ELECTRICAL CHARACTERISTICS

Ratings at $25^\circ C$ ambient temperature unless otherwise specified. 50 Hz or 60 Hz, resistive or inductive load.

	SYMBOLS	B40	B80	B125	B250	B380	UNITS
Maximum Recurrent Peak Reverse Voltage	V_{RRM}	65	125	200	400	600	Volts
Maximum RMS Input Voltage R + C-Load	V_{RMS}	40	80	125	250	380	Volts
Maximum Average Forward Output Current for free air operation at $T_A = 45^\circ C$	R + L-Load C - Load $I_{(AV)}$	1.6 1.5					Amps
Maximum DC Blocking Voltage	V_{DC}	65	125	200	400	600	Volts
Maximum Repetitive Peak Reverse Voltage	V_{RRM}	90	180	300	600	800	Volts
Maximum Peak Working Voltage	V_{RWM}	90	180	300	600	800	Volts
Maximum Non-Repetitive Peak Voltage	V_{RSM}	100	200	350	650	1000	Volts
Maximum Repetive Peak Forward Surge Current	I_{FRM}	10.0					Amps
Peak Forward Surge Current Single Sine wave on rated load at $T_J = 125^\circ C$	I_{FSM}	50.0					Amps
Rating for Fusing at $T_J = 125^\circ C$ ($t < 100ms$)	$I^2 t$	12.5					$A^2 S$
Min. Series Resistor C-Load $V_{RMS} = +$ or -10%	R_t	1.0	2.0	4.0	8.0	12.0	ohms
Maximum Load Capacitance +50% -10%	C_L	5000	2500	1000	500	200	μF
Maximum Instantaneous Forward Voltage Drop per element at 1.5A	V_F	1.0					Volts
Maximum Reverse Current at rated Repetitive Peak Voltage per element $T_A = 25^\circ C$	I_R	10.0					μA
Typical Thermal Resistance (Note 1)	$R_{\theta JA}$	36.0					$^\circ C/W$
Operating Temperature Range	T_J	-40 to +125					$^\circ C$
Storage Temperature Range	T_{STG}	-40 to +150					$^\circ C$

NOTES:

1. Thermal Resistance from Junction to Ambient mounted on P.C Board at .375" (9.5mm) Lead Lengths with $0.2" \times 0.2"$ (5.5mm x 5.5mm) Copper Pads.

RATINGS AND CHARACTERISTIC CURVES B40C 1500M THRU B380C 1500M SERIES

**FIG. 1 — DERATING CURVE
OUTPUT RECTIFIED CURRENT
FOR B40C 800M...B125C 800M**

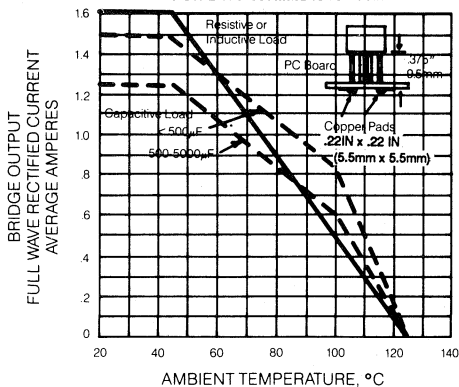

**FIG. 3 — TYPICAL
REVERSE CHARACTERISTICS**

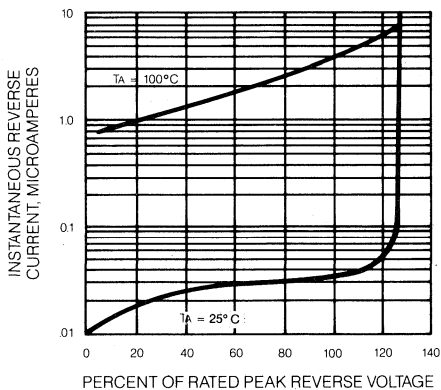

**FIG. 5 — MAXIMUM NON-REPETITIVE
PEAK FORWARD CURRENT**

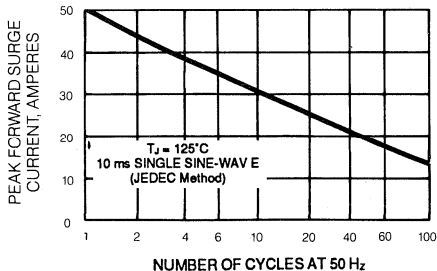

**FIG. 2 - DERATING CURVE
OUTPUT RECTIFIED CURRENT
B250 1500M... B380C 1500M**

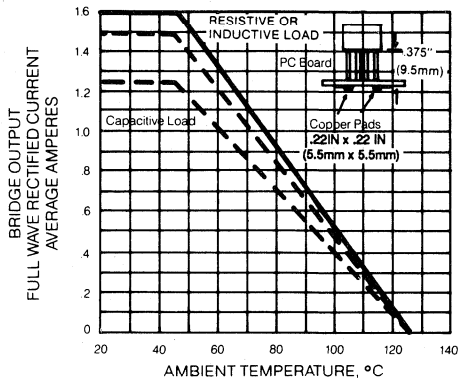
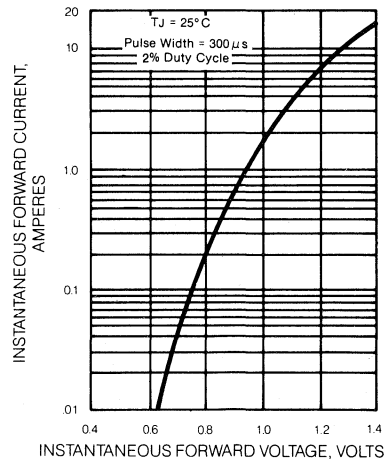
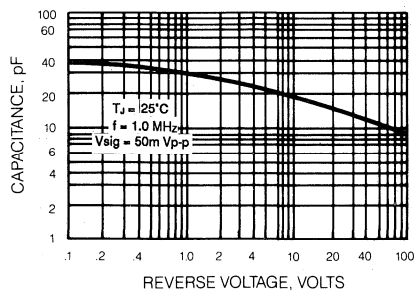

FIG. 4 — TYPICAL FORWARD CHARACTERISTICS



**FIG. 6 — TYPICAL JUNCTION CAPACITANCE
PER BRIDGE ELEMENT**



2W005M THRU 2W10M

MINIATURE SINGLE - PHASE SILICON BRIDGE RECTIFIER
VOLTAGE - 50 to 1000 Volts CURRENT - 2.0 Amperes

FEATURES

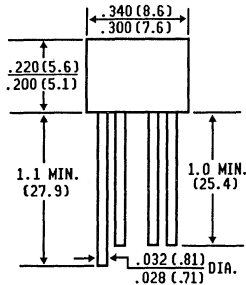

- ◆ This series is UL recognized under component index, file number E54214
- ◆ Plastic material used carries Underwriters Laboratory flammability recognition 94V-O
- ◆ High case dielectric strength
- ◆ Typical IR less than 0.1 μ A
- ◆ High overload surge capability
- ◆ Ideal for printed circuit board
- ◆ High temperature soldering guaranteed 265° C / 10 seconds / .375", (9.5mm) lead length / 5lbs., (2.3 kg) tension



MECHANICAL DATA

Case: Reliable low cost construction utilizing molded plastic technique resulting in an inexpensive product

Terminals: Plated Leads Solderable per MIL-STD-202, Method 208

Mounting Position: Any

Handling precautions: None

Weight: 0.05 ounce, 1.3 grams

Polarity: Polarity symbols marked on case

Dimensions in inches and (millimeters)

MAXIMUM RATINGS AND ELECTRICAL CHARACTERISTICS

Ratings at 25°C ambient temperature unless otherwise specified
 Single phase, half wave, 60 Hz, resistive or inductive load.
 For capacitive load, derate current by 20%

	SYMBOLS	2W0 05M	2W 01M	2W 02M	2W 04M	2W 06M	2W 08M	2W 10M	UNITS
Maximum Recurrent Peak Reverse Voltage	V_{RRM}	50	100	200	400	600	800	1000	Volts
Maximum RMS Voltage	V_{RMS}	35	70	140	280	420	560	700	Volts
Maximum DC Blocking Voltage	V_{DC}	50	100	200	400	600	800	1000	Volts
Maximum Average Forward Rectified Current .375",(9.5mm) lead length at $T_A = 25^\circ C$	$I_{(AV)}$	2.0							Amps
Peak Forward Surge Current Single sine-wave superimposed on rated load (JEDEC Method)	I_{FSM}	60.0							Amps
Rating for fusing ($t < 8.3ms$)	I^2t	15.0							A ² s
Maximum Instantaneous Forward Voltage drop per element at 2.0A	V_F	1.1							Volts
Maximum DC Reverse Current $T_A = 25^\circ C$ at Rated DC Blocking Voltage per element $T_A = 100^\circ C$	I_R	10.0 1.0							μA mA
Typical Junction Capacitance per element (Note 1)	C_J	30.0							pf
Typical Thermal Resistance (Note 2)	$R_{\theta JA}$	36.0							°C/W
Operating Temperature Range	T_J	-50 to + 125							°C
Storage Temperature Range	T_{STG}	-50 to +150							°C

NOTES:

1. Measured at 1.0 MHz and applied reverse voltage of 4.0 V_{DC}.
2. Thermal Resistance from Junction to Ambient at .375", 9.5mm lead length mounted on P.C. Board with, .2" x .2" (5.5 mm x 5.5 mm) Copper Pads.

RATINGS AND CHARACTERISTIC CURVES 2W005M THRU 2W10M

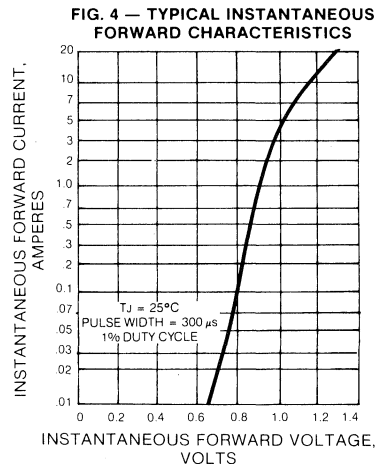
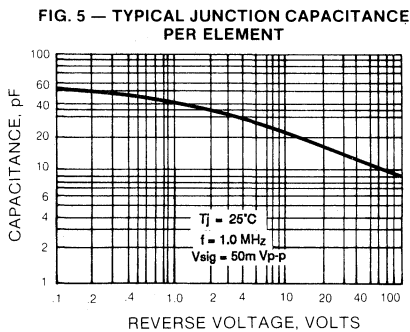
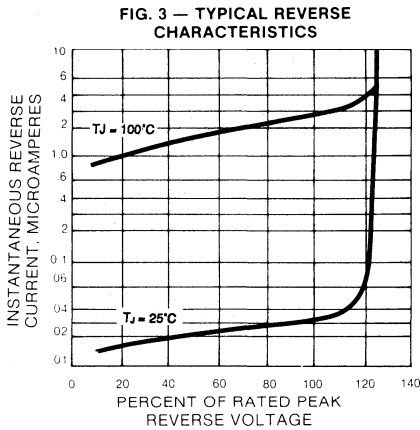
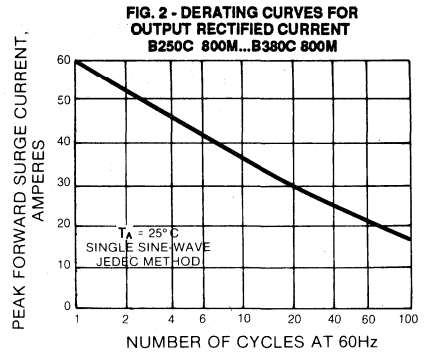
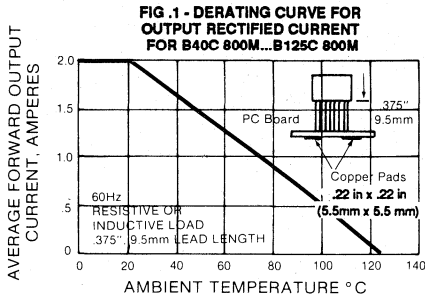

2KBP005M THRU 2KBP10M 3N253 THRU 3N259

MINIATURE GLASS PASSIVATED SINGLE - PHASE SILICON BRIDGE RECTIFIER
VOLTAGE - 50 to 1000 Volts CURRENT - 2.0 Amperes

FEATURES

- ◆ This series is UL recognized under component index, file number E54214
- ◆ Plastic material used carries Underwriters Laboratory flammability recognition 94V-O
- ◆ Glass passivated chip junctions
- ◆ Typical I_R less than $0.1 \mu A$
- ◆ Built-in printed circuit board stand-offs
- ◆ High case dielectric strength
- ◆ Ideal for printed circuit board
- ◆ High temperature soldering guaranteed: $265^\circ C / 10$ seconds at 5 lbs., (2.3kg) tension

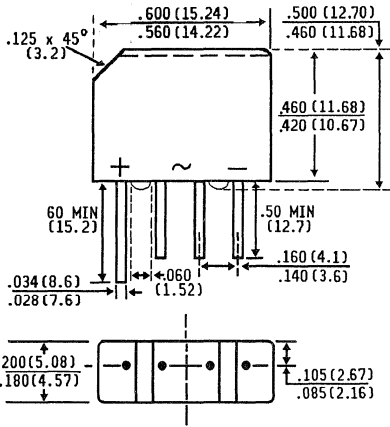
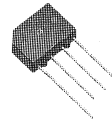

Dimensions in inches
and
(millimeters)

MECHANICAL DATA

Case: Reliable low cost construction utilizing molded plastic technique

Terminals: Plated Lead solderable per MIL-STD-202, Method 208

Mounting position: Any

Weight : 0.06 ounce, 1.70 grams

MAXIMUM RATINGS AND ELECTRICAL CHARACTERISTICS

Ratings at $25^\circ C$ ambient temperature unless otherwise specified.
60 Hz Resistive or inductive load.

	SYMBOLS	2KBP 005M 3N253	2KBP 01M 3N254	2KBP 02M 3N255	2KBP 04M 3N256	2KBP 06M 3N257	2KBP 08M 3N258	2KBP 10M 3N259	UNITS
* Maximum Recurrent Peak Reverse Voltage	V_{RRM}	50	100	200	400	600	800	1000	Volts
* Maximum RMS Voltage	V_{RMS}	35	70	140	280	420	560	700	Volts
* Maximum DC Blocking Voltage	V_{DC}	50	100	200	400	600	800	1000	Volts
* Maximum Average Forward Output Rectified Current at $T_A = 55^\circ C$	$I_{(AV)}$	2.0							Amps
* Peak Forward Surge Current Single sine-wave superimposed on rated load (JEDEC Method) Rating for fusing ($t < 8.35ms$)	I_{FSM} I^2t	60.0				15.0			Amps A^2s
* Maximum Instantaneous Forward Voltage drop per element at 3.14A	V_F	1.1							Volts
* Maximum DC Reverse Current $T_A = 25^\circ C$ at Rated DC Blocking Voltage per element $T_A = 125^\circ C$	I_R	500				10.0			μA
Typical Junction Capacitance per element (Note 1)	C_J	25.0							pf
Typical Thermal Resistance (Note 2)	$R_{\theta JA}$	30.0							$^\circ C/W$
* Operating and Storage Temperature Range,	T_J, T_{STG}	-55 to +165							$^\circ C$

NOTES:

1. Measured at 1.0 MHz and applied reverse voltage of 4.0 Volts.
2. Thermal Resistance from Junction to Ambient mounted on P.C. Board with .47" x .47" (12mm x 12mm) Copper Pads.
* JEDEC Registered Values

RATINGS AND CHARACTERISTIC CURVES 3N253 THRU 3N259 / 2KBP005M THRU 2KBP10M

FIG.1—DERATING CURVE FOR OUTPUT RECTIFIED CURRENT

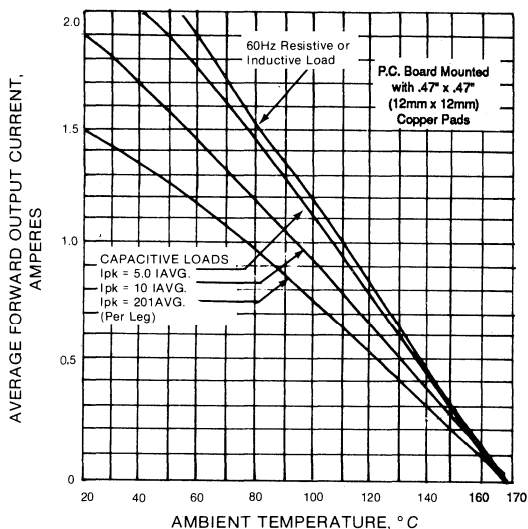

FIG.2—MAXIMUM NON-REPETITIVE PEAK FORWARD SURGE CURRENT

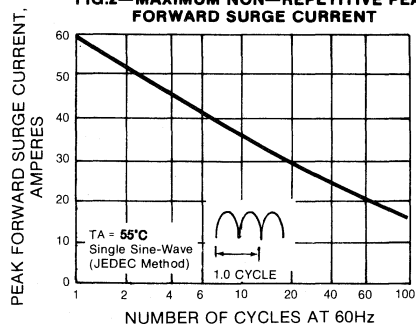

FIG. 4 — TYPICAL FORWARD CHARACTERISTICS PER ELEMENT

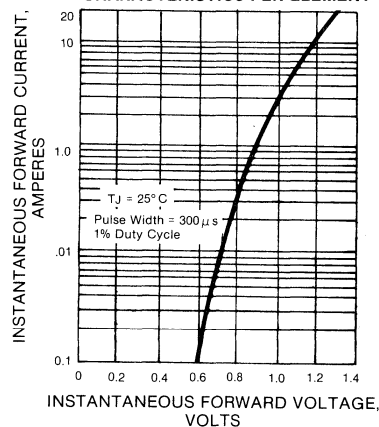

FIG. 3 — TYPICAL REVERSE CHARACTERISTICS

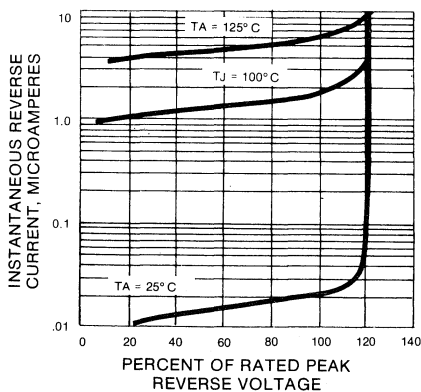
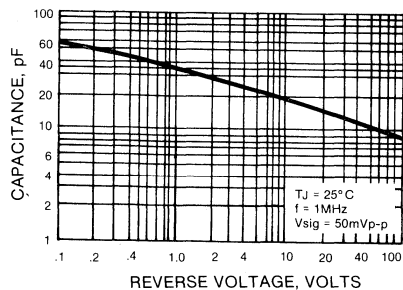

FIG.5—TYPICAL JUNCTION CAPACITANCE PER ELEMENT



KBPC1005 THRU KBPC110

GLASS PASSIVATED SINGLE-PHASE SILICON BRIDGE RECTIFIER
VOLTAGE - 50 to 1000 Volts CURRENT - 3.0 Amperes

FEATURES

- ◆ This series is UL recognized under component index, file number E54214
- ◆ High temperature metallurgically bonded internal rectifiers
- ◆ Plastic material used carries Underwriters Laboratory flammability recognition 94V-O
- ◆ Glass passivated cavity - free rectifier junctions
- ◆ Typical I_R less than $0.1 \mu A$
- ◆ High temperature soldering guaranteed: $265^\circ C / 10$ seconds / $.375"$, (9.5mm) lead length / 5lbs., (2.3 kg) tension

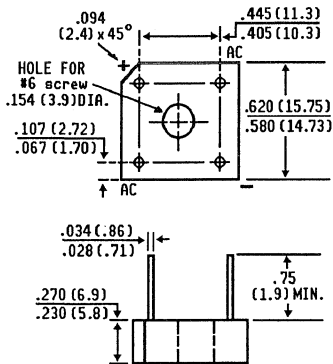
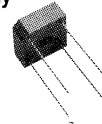

Polarity shown on side of case:
positive lead by beveled corner

Dimensions in inches
and
(millimeters)

MECHANICAL DATA

Case: Void-free plastic package

Terminals: Plated leads solderable per MIL-STD-202, Method 208

Mounting: Thru hole for #6 screw

Mounting Position: Any

Weight: 0.2 ounces, 5.5 gram

MAXIMUM RATINGS AND ELECTRICAL CHARACTERISTICS

Ratings at $25^\circ C$ ambient temperature unless otherwise specified
 60 Hz, resistive or inductive load.
 For capacitive load, derate current by 20%.

		KBPC SYMBOLS	KBPC 1005	KBPC 101	KBPC 102	KBPC 104	KBPC 106	KBPC 108	KBPC 110	UNITS
Maximum Recurrent Peak Reverse Voltage	V_{RRM}	50	100	200	400	600	800	1000		Volts
Maximum RMS Voltage	V_{RMS}	35	70	140	280	420	560	700		Volts
Maximum DC Blocking Voltage	V_{DC}	50	100	200	400	600	800	1000		Volts
Maximum Average Forward Rectified Output Current at	$I_{(AV)}$				3.0					Amps
					2.0					
Peak Forward Surge Current Single sine-wave superimposed on rated load (JEDEC Method)	I_{FSM}				50.0					Amps
Maximum Instantaneous Forward Voltage drop per element at 1.5A	V_F				1.1					Volts
Maximum DC Reverse Leakage at Rated DC Blocking Voltage per element	I_R				10.0					μA
					50.0					μA
Typical Junction Capacitance per element (Note 3)	C_J				20.0					pf
Typical Thermal Resistance (Note 1)	$R_{\theta JC}$				10.0					$^\circ C/W$
Operating Temperature Range	T_J				-50 to +150					$^\circ C$
Storage Temperature Range	T_{STG}				-50 to +150					$^\circ C$

NOTES:

1. Bridge mounted on a $4" \times 4" \times .11$ THK (10.5cm x 10.5cm x 0.3cm.) AL. PLate
2. Bridge mounted on P.C. Board .375", (9.5mm) lead lengths with .47" sq. (12 mm sq.) Copper Pads
3. Measured at 1.0 MHz and applied reverse voltage of 4.0 Volts.

RATINGS AND CHARACTERISTIC CURVES KBPC1005 THRU KBPC110

FIG. 1 — DERATING CURVE FOR OUTPUT RECTIFIED CURRENT

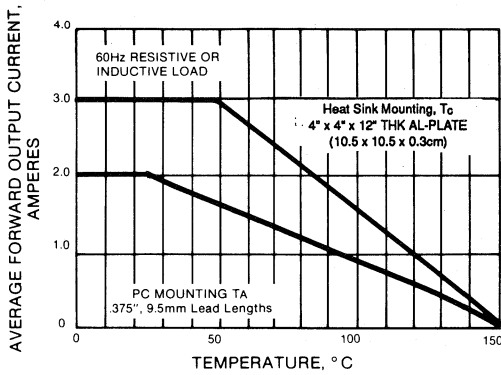

FIG. 2 — MAXIMUM NON-REPETITIVE PEAK FORWARD SURGE CURRENT

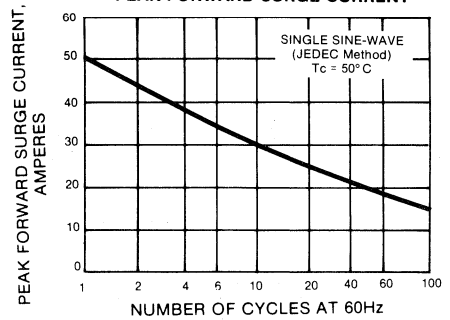

FIG. 3 — TYPICAL FORWARD CHARACTERISTICS PER ELEMENT

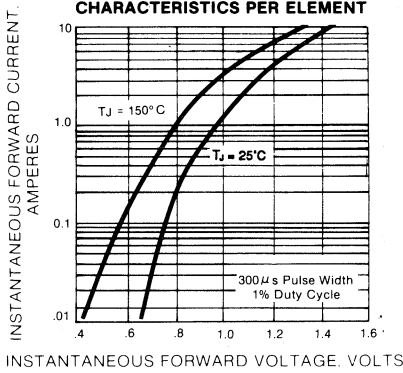

FIG. 4 — TYPICAL REVERSE CHARACTERISTICS

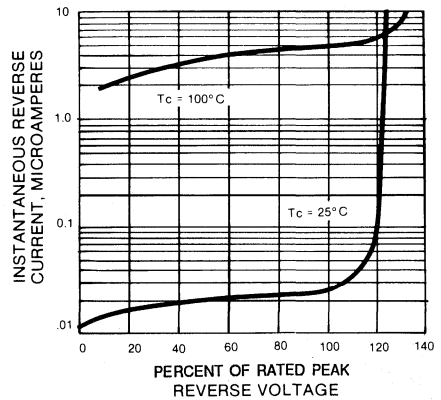
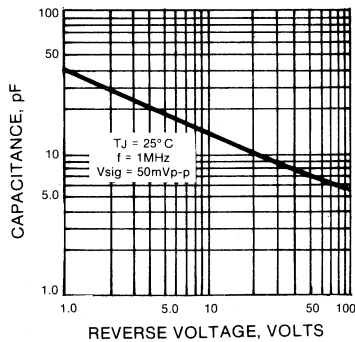

FIG. 5 — TYPICAL JUNCTION CAPACITANCE PER ELEMENT



B40C / B80C / B125C / B250C / B380C 3700 / 2200 SERIES

SINGLE - PHASE SILICON BRIDGE RECTIFIER
Voltage - 65 to 600 Volts Current - 3.7 Amperes

FEATURES

- ◆ Plastic package has Underwriters Laboratory Flammability Classification 94V-0
- ◆ High surge current capability
- ◆ Typical I_R less than $0.1 \mu A$
- ◆ Ideal for P.C. board mounting
- ◆ Built-in P.C. Board Stand-offs
- ◆ High temperature soldering guaranteed: $250^\circ C$ for 5 seconds

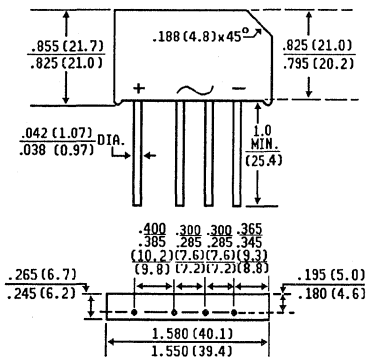

Dimensions in inches and (millimeters)

MECHANICAL DATA

Case: Reliable low cost construction utilizing molded plastic technique

Terminals: Plated Leads solderable per MIL-STD-202, Method 208

Mounting Position: Any

Weight: 0.92 ounce, 25.3 grams

MAXIMUM RATINGS AND ELECTRICAL CHARACTERISTICS

Ratings at $25^\circ C$ ambient temperature unless otherwise specified. 50 Hz or 60 Hz, resistive or inductive load.

	SYMBOLS	B40	B80	B125	B250	B380	UNITS
Maximum Recurrent Peak Reverse Voltage	V_{RRM}	65	125	200	400	600	Volts
Maximum RMS Input Voltage R + C-Load	V_{RMS}	40	80	125	250	380	Volts
Maximum Average Forward Output Current for natural cooling operation at $T_A = 45^\circ C$ R + L-Load C - Load on Chassis = $31IN^2, 200cm^2, T_A=45^\circ C$ C - Load R + L-Load	$I_{(AV)}$			2.7 2.2 3.7 4.8			Amps
Maximum DC Blocking Voltage (Note 1)	V_{DC}	65	125	200	400	600	Volts
Maximum Repetitive Peak Reverse Voltage (Note 1)	V_{RRM}	100	90	300	600	800	Volts
Maximum Repetive Peak Forward Surge Current	I_{FRM}			15.0			Amps
Peak Forward Surge Current Single Sine wave on rated load at $T_J = 25^\circ C$ $T_A = 150^\circ C$	I_{FSM}			100 80.0			Amps
Rating for Fusing at ($t < 10ms$) $T_J = 25^\circ C$ $T_J = 150^\circ C$	I^2t			50.0 32.0			A^2S
Minimum Series Resistance at V_{RMS}	R_t	0.6	1.2	1.4	2.8	4.2	ohms
Maximum Reservoir Capacitor	C_L	5000	2500	1000	600	300	μF
Maximum Instantaneous Forward Voltage Drop per element at 3.OA	V_F			1.0			Volts
Maximum Reverse Current at rated Repetitive Peak Voltage $T_A = 25^\circ C$ $T_J = 150^\circ C$	I_R			10.0 6.0			μA mA
Typical Thermal Resistance (Note 2)	$R_{\theta JA}$			3.0			$^\circ C/W$
Operating and Storage Temperature Range	T_J, T_{STG}			-50 to +150			$^\circ C$

NOTES:

1. Valid for each bridge element
2. Thermal Resistance from Junction to Ambient with bridge mounted on a $3"sq. \times .11" THK (7.5 cm.sq. \times 0.3 cm)$ AL Plate

RATINGS AND CHARACTERISTIC CURVES B40C THRU B380C 3700/2200

FIG. 1 — DERATING CURVE FOR OUTPUT RECTIFIED CURRENT

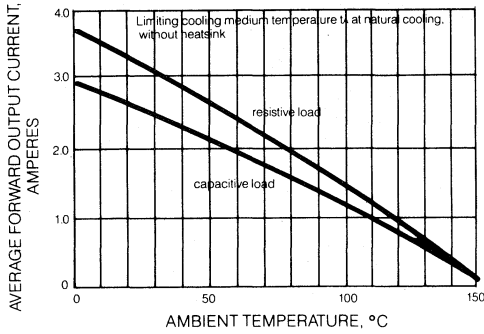

FIG. 2 — DERATING CURVE FOR OUTPUT RECTIFIED CURRENT

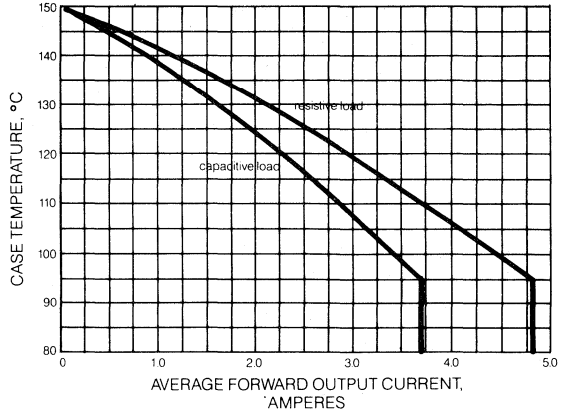

FIG. 3 — TYPICAL FORWARD CHARACTERISTIC PER BRIDGE ELEMENT

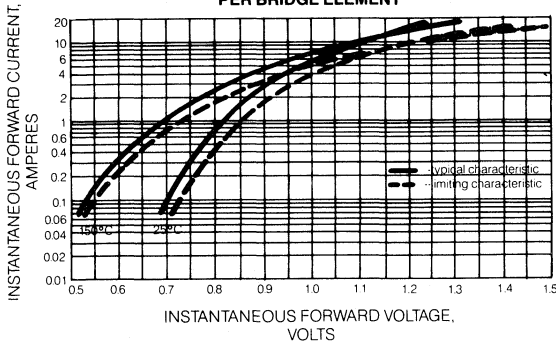

FIG. 4 — MAXIMUM NON-REPETITIVE SURGE CURRENT

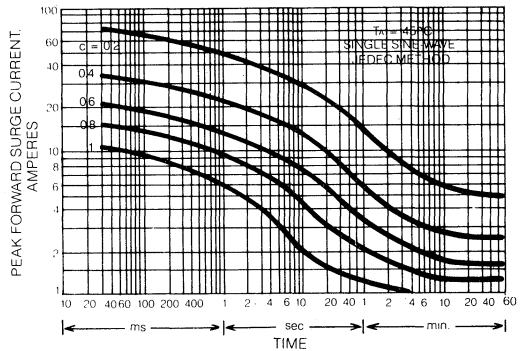

FIG. 5 — MAXIMUM TOTAL BRIDGE POWER DISSIPATION

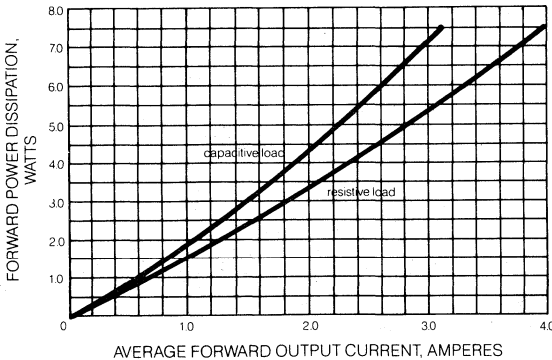
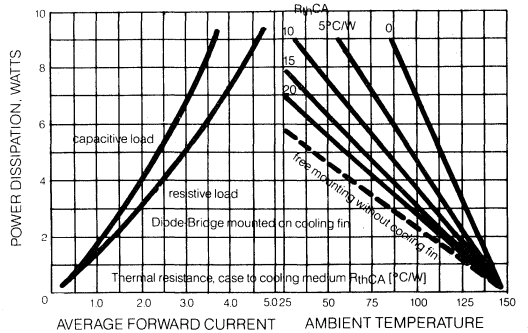

FIG. 6 — MEAN AVERAGE FORWARD CURRENT



KBL005 THRU KBL10

SINGLE - PHASE SILICON BRIDGE RECTIFIERS
VOLTAGE - 50 to 1000 Volts CURRENT - 4.0 Amperes

FEATURES

- ◆ This series is UL recognized under component index, file number E54214
- ◆ Plastic material used carries Underwriters Laboratory Flammability Classification 94V-O
- ◆ Ideal for printed circuit board
- ◆ Reliable low cost construction utilizing molded plastic technique
- ◆ Surge overload rating of 200 Amperes peak
- ◆ High temperature soldering guaranteed: 250° C /10 seconds / .375", (9.5mm) lead length / 5lbs., (2.3 kg) tension

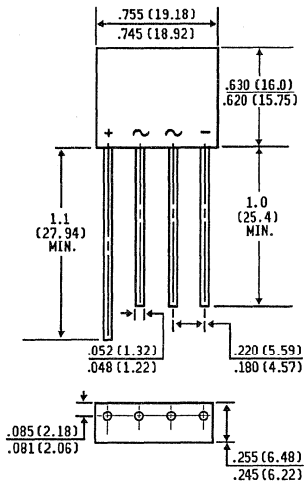
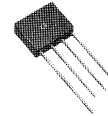

Dimensions in inches
and
(millimeters)

MECHANICAL DATA

Case: Reliable low cost construction utilizing molded plastic technique

Terminals: Plated Lead solderable per MIL-STD-202, Method 208

Mounting Position: Any

Weight: 0.2 ounce, 5.6 grams

MAXIMUM RATINGS AND ELECTRICAL CHARACTERISTICS

Ratings at 25°C ambient temperature unless otherwise specified.
 Resistive or inductive load, 60 Hz.,
 For capacitive load, derate current by 20%.

	SYMBOLS	KBL 005	KBL 01	KBL 02	KBL 04	KBL 06	KBL 08	KBL 10	UNITS
Maximum Recurrent Peak Reverse Voltage	V _{RRM}	50	100	200	400	600	800	1000	Volts
Maximum RMS Voltage	V _{RMS}	35	70	140	280	420	560	700	Volts
Maximum DC Blocking Voltage	V _{DC}	50	100	200	400	600	800	1000	Volts
Maximum Average Forward Output Current at T _A = 50°C	I _(AV)	4.0							Amps
Peak Forward Surge Current Single sine-wave superimposed on rated load (JEDEC Method)	I _{FSM}	200							Amps
Maximum Instantaneous Forward Voltage drop per element at 4.0A	V _F	1.1							Volts
Maximum DC Current at Rated DC Blocking Voltage T _A = 25°C T _C = 150°C	I _R	10.0							μA mA
Typical Thermal Resistance (Note 1)	R _{θJA}	10.0							°C/W
Operating and Storage Temperature Range	T _{J,TSTG}	-50 to +150							°C

NOTES:

1. Thermal Resistance from Junction to Ambient with units mounted on a 3" x .11" THK (7.5cm. x 0.3cm.) Cu. Plate."

RATINGS AND CHARACTERISTIC CURVES KBL005 THRU KBL10

FIG. 1 — DERATING CURVE FOR OUTPUT RECTIFIED CURRENT

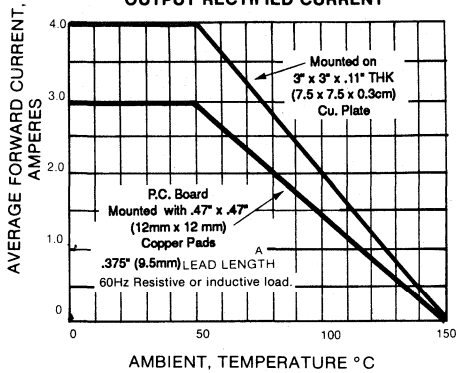

FIG. 3 — MAXIMUM NON-REPETITIVE PEAK FORWARD SURGE CURRENT

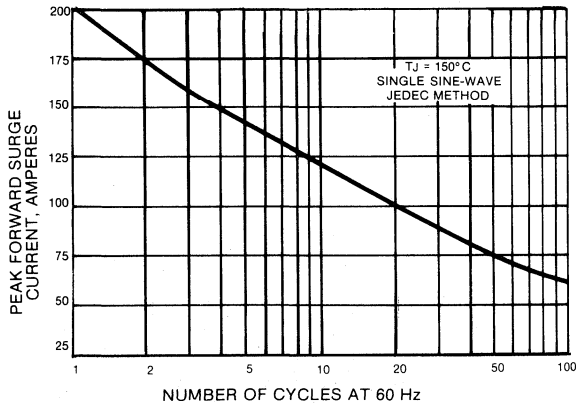

FIG. 2 — TYPICAL INSTANTANEOUS FORWARD CHARACTERISTICS PER ELEMENT

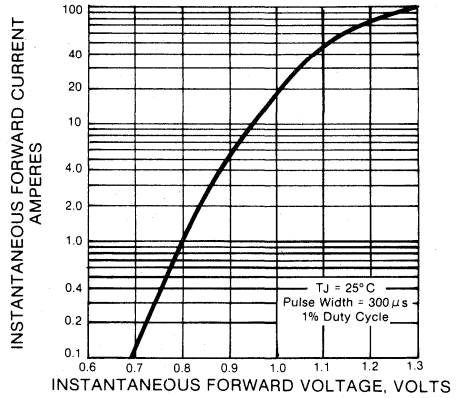

FIG. 4 — TYPICAL REVERSE CHARACTERISTICS

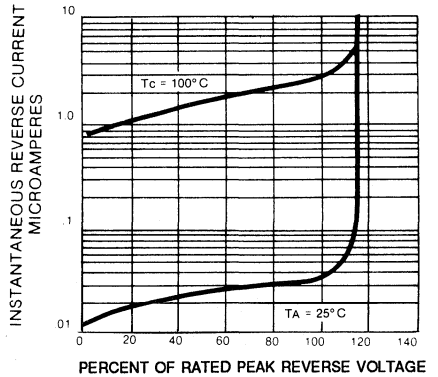
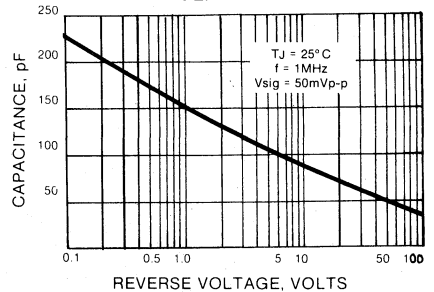

FIG. 5 — TYPICAL JUNCTION CAPACITANCE PER ELEMENT



KBU4A THRU KBU4M

SILICON SINGLE - PHASE SILICON BRIDGE RECTIFIERS
VOLTAGE - 50 to 1000 Volts CURRENT - 4.0 Amperes

FEATURES

- ◆ This series is UL recognized under component index, file number E54214
- ◆ Plastic material used carries Underwriters Laboratory Flammability Classification 94V-0
- ◆ Ideal for printed circuit board
- ◆ Reliable low cost construction utilizing molded plastic technique
- ◆ Surge overload rating of 200 Amperes peak
- ◆ High temperature soldering guaranteed: 250° C /10 seconds / .375", (9.5mm) lead length / 5lbs., (2.3 kg) tension

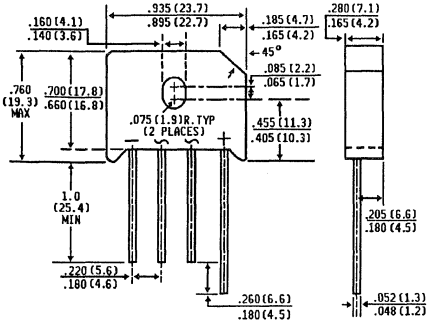
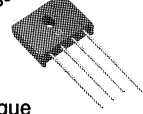

*Dimensions in inches
and
(millimeters)*

MECHANICAL DATA

Case: Reliable low cost construction utilizing molded plastic technique

Terminals: Plated Lead solderable per MIL-STD-202, Method 208

Mounting Position: Any

Mounting Torque: 5 in. lb. max.

Weight: 0.3 ounce, 8.0 gram

MAXIMUM RATINGS AND ELECTRICAL CHARACTERISTICS

Ratings at 25°C ambient temperature unless otherwise specified

Resistive or inductive load, 60 Hz.

For capacitive load, derate current by 20%

		KBU 4A	KBU 4B	KBU 4D	KBU 4G	KBU 4J	KBU 4K	KBU 4M	UNITS
Maximum Recurrent Peak Reverse Voltage	V _{RRM}	50	100	200	400	600	800	1000	Volts
Maximum RMS Voltage	V _{RMS}	35	70	140	280	420	560	700	Volts
Maximum DC Blocking Voltage	V _{DC}	50	100	200	400	600	800	1000	Volts
Maximum Average Forward Rectified Output Current at	I <sub(av)< sub=""></sub(av)<>				4.0				Amps
Peak Forward Surge Current Single superimposed on rated load (JEDEC Method)	I _{FSM}				200				Amps
Maximum Instantaneous Forward Voltage drop per element at 4.0A	V _F				1.0				Volts
Maximum DC Reverse Leakage at Rated DC Blocking Voltage per element	I _R				10.0				μA
Typical Thermal Resistance (Note 1)	R _{θJC}				3.3				°C/W
Operating and Storage Temperature Range	T _J , T _{STG}				-50 to +150				°C

NOTES:

1. Thermal Resistance from Junction to Case with units mounted on a 2.0" x 1.6" x 0.3" THK (5cm. x 4cm. x 0.8cm.) Al. Plate.

RATINGS AND CHARACTERISTIC CURVES KBU4A THRU KBU4M

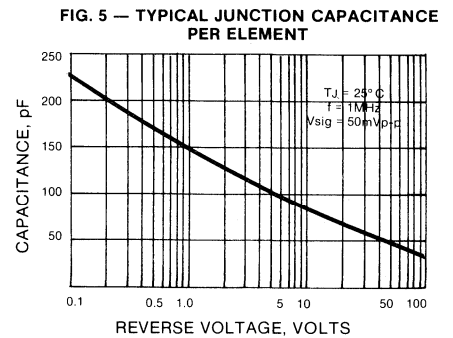
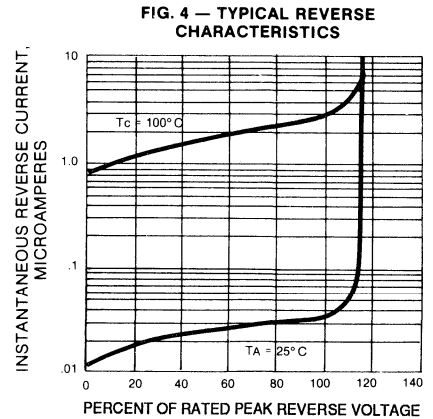
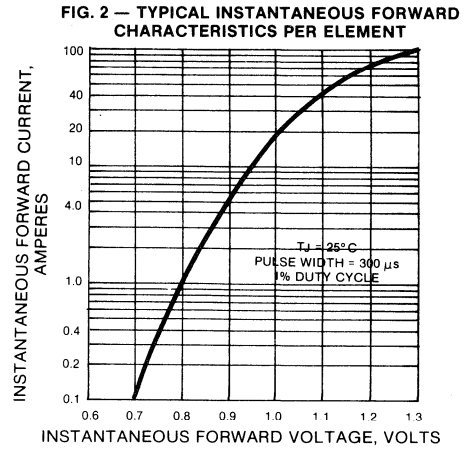
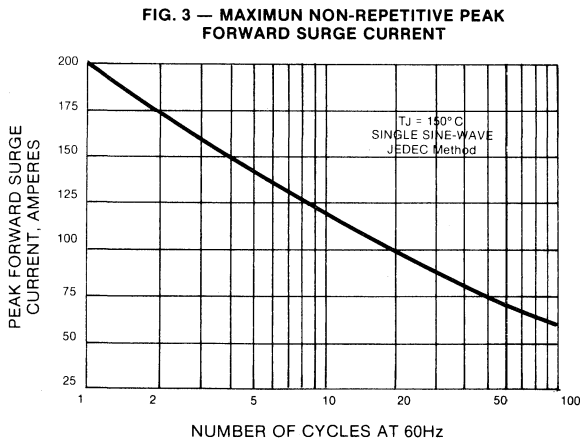
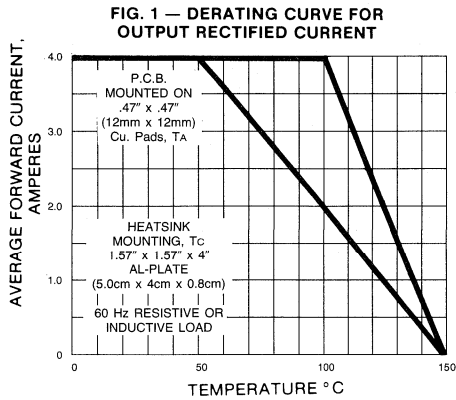

B40C / B80C / B125C / B250C / B380C 5000 / 3300

SINGLE - PHASE SILICON BRIDGE RECTIFIERS
Voltage - 65 to 600 Volts Current - 5.0 Amperes

FEATURES

- ◆ Plastic package has Underwriters Laboratory Flammability Classification 94V-0
- ◆ High surge current capability
- ◆ Typical I_R less than 0.1 μ A
- ◆ Ideal for printed circuit board
- ◆ Built-in printed board stand-offs
- ◆ High temperature soldering guaranteed: 250°C for 5 seconds

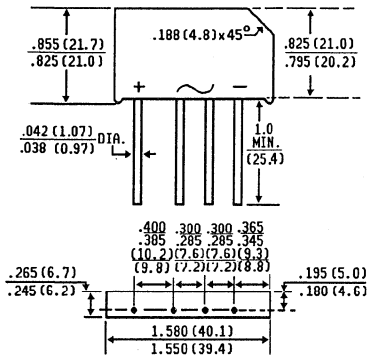
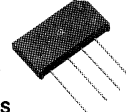

Dimensions in inches and (millimeters)

MECHANICAL DATA

Case: Reliable low cost construction utilizing molded plastic technique

Terminals: Plated Leads solderable per MIL-STD-202, Method B08

Mounting Position: Any

Weight: 0.92 ounce, 25.3 gram

MAXIMUM RATINGS AND ELECTRICAL CHARACTERISTICS

Ratings at 25°C ambient temperature unless otherwise specified. 50 Hz or 60 Hz, resistive or inductive load.

	SYMBOLS	B40	B80	B125	B250	B380	UNITS
Maximum Recurrent Peak Reverse Voltage	V_{RRM}	65	125	200	400	600	Volts
Maximum RMS Input Voltage R + C-Load	V_{RMS}	40	80	125	250	380	Volts
Maximum Average Forward Output Current for natural cooling operation at $T_A = 45^\circ\text{C}$ R + L-Load C - Load on Chassis = 31 IN ² , 200cm ² , $T_A=45^\circ\text{C}$ C - Load R + L-Load	$I_{(AV)}$			4.0 3.3 5.0 6.0			Amps
Maximum DC Blocking Voltage (Note 1)	V_{DC}	65	125	200	400	600	Volts
Maximum Repetitive Peak Reverse Voltage (Note 1)	V_{RRM}	100	190	300	600	900	Volts
Maximum Repetitive Peak Forward Surge Current	I_{FRM}			30.0			Amps
Peak Forward Surge Current Single Sine wave on rated load (JEDEC) Method) at $T_J = 25^\circ\text{C}$ $T_J = 150^\circ\text{C}$	I_{FSM}			100 80			Amps
Rating for Fusing at ($t < 10\text{ms}$) $T_J = 25^\circ\text{C}$ $T_J = 150^\circ\text{C}$	I^2T			312 200			A ² S
Minimum Series Resistance at V_{RMS}	R_t	0.15	0.3	0.6	1.2	1.8	ohms
Maximum Reservoir Capacitor	C_L	1000	5000	5000	2500	1000	μF
Maximum Instantaneous Forward Voltage Drop per element at 5.0A	V_F			1.1			Volts
Maximum Reverse Current at rated Repetitive Peak Reverse Voltage $T_A = 25^\circ\text{C}$ $T_J = 150^\circ\text{C}$	I_R			10.0 6.0			μA mA
Typical Thermal Resistance (Note 2)	$R_{\theta JA}$			3.0			$^\circ\text{C/W}$
Operating and Storage Temperature Range	T_J, T_{STG}			-50 to +150			$^\circ\text{C}$

NOTES:

1. Valid for each bridge element
2. Thermal Resistance from Junction to Ambient with unit mounted on 3"sq. x .11" THK (7.5 cm.sq. x 0.3 cm.) Al Plate

RATINGS AND CHARACTERISTIC CURVES B40C thru B380C 5000 / 3300

FIG. 1 — DERATING CURVE FOR OUTPUT RECTIFIED CURRENT

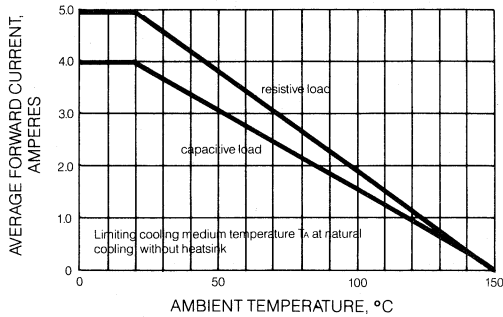

FIG. 2 — DERATING CURVE FOR OUTPUT RECTIFIED CURRENT

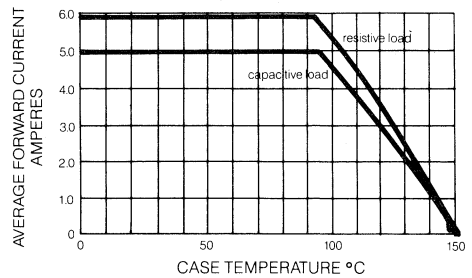

FIG. 3 — TYPICAL INSTANTANEOUS FORWARD CHARACTERISTIC PER BRIDGE ELEMENT

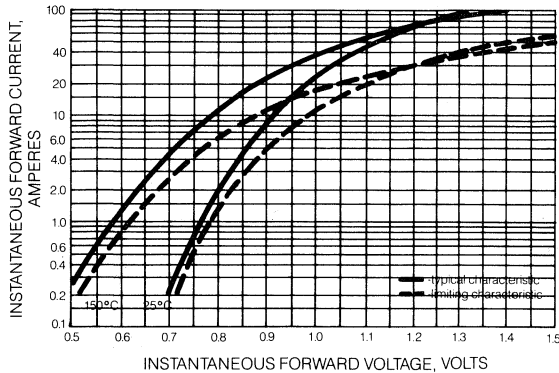

FIG. 4 — MAXIMUM NON-REPETITIVE PEAK FORWARD SURGE CURRENT

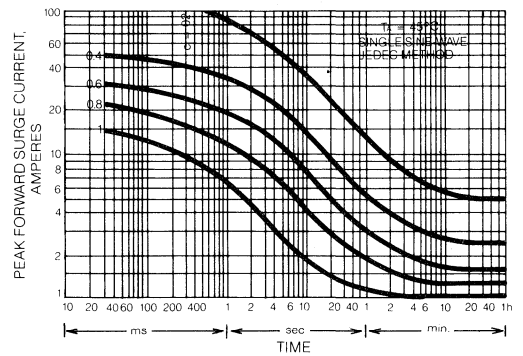

FIG. 5 — MAXIMUM TOTAL BRIDGE POWER DISSIPATION

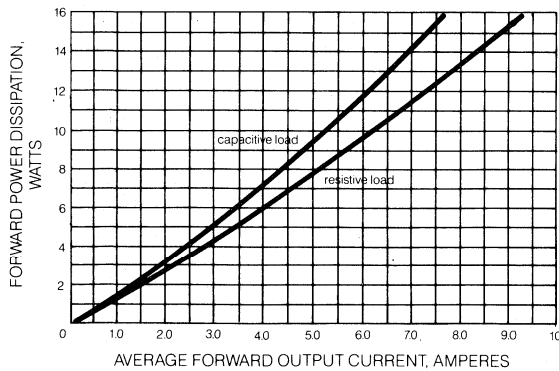
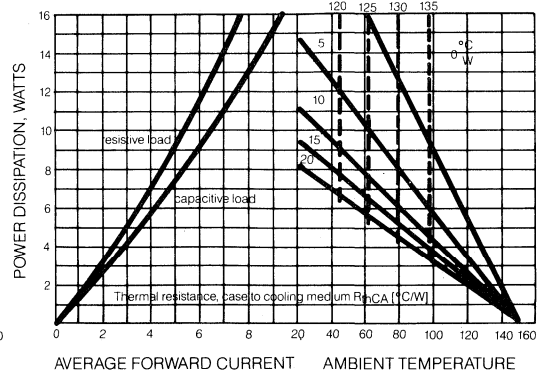

FIG. 6 — MEAN AVERAGE FORWARD CURRENT CASE TEMPERATURE



KBU6A THRU KBU6M

SINGLE - PHASE SILICON BRIDGE RECTIFIERS
VOLTAGE - 50 to 1000 Volts CURRENT - 6.0 Amperes

FEATURES

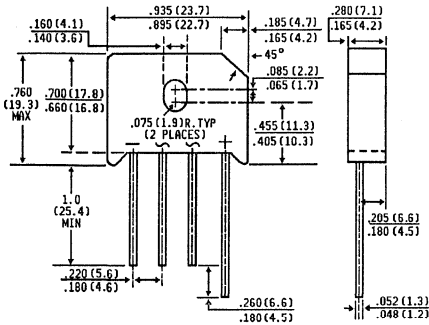

Dimensions in inches
and
(millimeters)

- ◆ This series is UL recognized under component index, file number E54214
- ◆ Plastic material used carries Underwriters Laboratory Flammability Classification 94V-0
- ◆ Ideal for printed circuit board
- ◆ Reliable low cost construction utilizing molded plastic technique
- ◆ Surge overload rating of 250 Amperes peak
- ◆ High temperature soldering guaranteed: 250° C / 10 seconds / .375", (9.5mm) lead length / 5lbs., (2.3 kg) tension

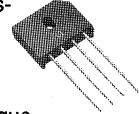

MECHANICAL DATA

Case: Reliable low cost construction utilizing molded plastic technique

Terminals: Plated Lead solderable per MIL-STD-202, Method 208

Mounting Position: Any

Mounting Torque: 5 in. lb. max.

Weight: 0.3 ounce, 8.0 gram

MAXIMUM RATINGS AND ELECTRICAL CHARACTERISTICS

Ratings at 25°C ambient temperature unless otherwise specified.
 60 Hz Resistive or inductive load.
 For capacitive load, derate current by 20%.

		KBU 6A	KBU 6B	KBU 6D	KBU 6G	KBU 6J	KBU 6K	KBU 6M	UNITS
Maximum Recurrent Peak Reverse Voltage	V _{RRM}	50	100	200	400	600	800	1000	Volts
Maximum RMS Voltage	V _{RMS}	35	70	140	280	420	560	700	Volts
Maximum DC Blocking Voltage	V _{DC}	50	100	200	400	600	800	1000	Volts
Maximum Average Forward Rectified Output Current at	I _(AV)	6.0							Amps
		T _C = 100°C							
		T _A = 40°C							
Peak Forward Surge Current Single sine-wave superimposed on rated load (JEDEC Method)	I _{FSM}	250							Amps
Maximum Instantaneous Forward Voltage drop per element at 6.0A	V _F	1.0							Volts
Maximum DC Reverse Leakage at Rated DC Blocking Voltage	I _R	10.0							μA
		200							
Typical Thermal Resistance (Note 1)	R _{θJC}	4.7							°C/W
Operating and Storage Temperature Range	T _J , T _{STG}	-50 to +150							°C

NOTES:

1. Thermal Resistance from Junction to Case with units mounted on a 2.6" x 1.4 x .06" THK (6.5cm. x 3.5cm. x 1.5cm.) Al. Plate.

RATINGS AND CHARACTERISTIC CURVES KBU6A THRU KBU6M

FIG. 1 — DERATING CURVE FOR OUTPUT RECTIFIED CURRENT

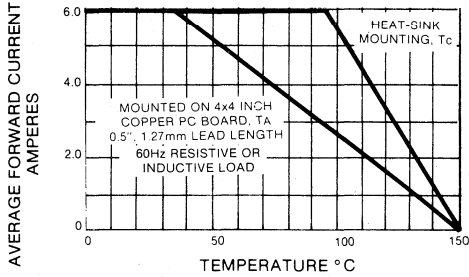

FIG. 2 — TYPICAL INSTANTANEOUS FORWARD CHARACTERISTICS PER ELEMENT

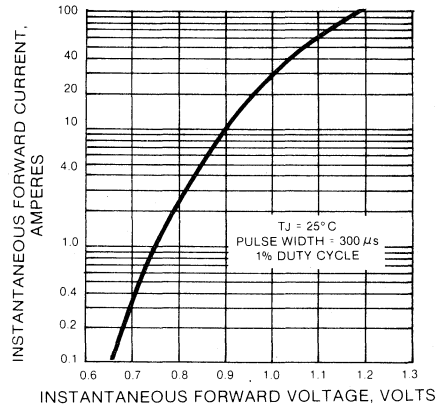

FIG. 3 — TYPICAL REVERSE CHARACTERISTICS

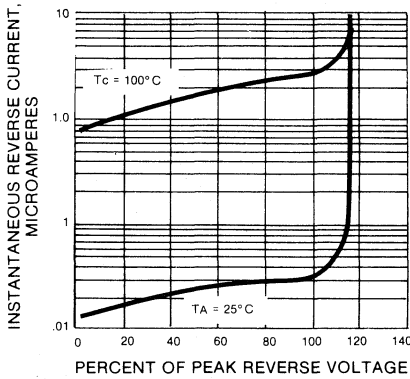

FIG. 5 — TYPICAL JUNCTION CAPACITANCE PER ELEMENT

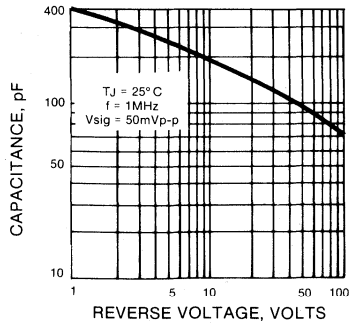
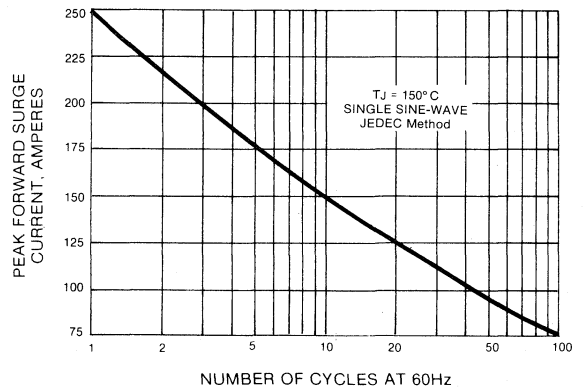

FIG. 4 — MAXIMUM NON-REPETITIVE PEAK FORWARD SURGE CURRENT



KBPC6005 THRU KBPC610

SINGLE - PHASE SILICON BRIDGE RECTIFIER
VOLTAGE - 50 to 1000 Volts CURRENT - 6.0 Amperes

FEATURES

- ◆ This series is UL recognized under component index, file number E54214
- ◆ Plastic material used carries Underwriters Laboratory Flammability recognition 94V-O
- ◆ High surge capability
- ◆ Ideal for printed circuit board
- ◆ Typical I_R less than .1 μ A
- ◆ High temperature soldering guaranteed 250° C /10 seconds / .375", (9.5mm) lead length / 5lbs., (2.3 kg) tension

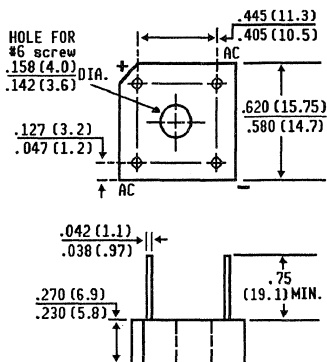
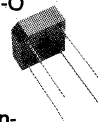

Polarity shown on side of case:
positive lead by beveled corner

Dimensions in inches
and
(millimeters)

MECHANICAL DATA

Case: Reliable low cost construction utilizing molded plastic technique

Terminals: Plated Lead solderable per MIL-STD-202, Method 208

Mounting Position: Any

Weight: 0.2 ounce, 5.5 gram

Mounting Torque: 5 in. lb. max.

MAXIMUM RATINGS AND ELECTRICAL CHARACTERISTICS

Ratings at 25°C ambient temperature unless otherwise specified
 Resistive or inductive load, 60 Hz.
 For capacitive load, derate current by 20%

		KBPC 6005	KBPC 601	KBPC 602	KBPC 604	KBPC 606	KBPC 608	KBPC 610	UNITS
Maximum Recurrent Peak Reverse Voltage	V_{RRM}	50	100	200	400	600	800	1000	Volts
Maximum RMS Voltage	V_{RMS}	35	70	140	280	420	560	700	Volts
Maximum DC Blocking Voltage	V_{DC}	50	100	200	400	600	800	1000	Volts
Maximum Average Forward Rectified Output Current at	$I_{(AV)}$			6.0					Amps
				3.0					
Peak Forward Surge Current Single sine-wave superimposed on rated load (JEDEC Method) at $T_J=150^\circ\text{C}$	I_{FSM}			150					Amps
Maximum Instantaneous Forward Voltage drop per element at 3.0A	V_F			1.2					Volts
Maximum Reverse Leakage at Rated DC Blocking Voltage	I_R			10.0					μ A
				1.0					mA
Maximum A.C Operating Junction Temperature	T_J			+150					°C
Typical Thermal Resistance (Note 1)	$R_{\theta JC}$			8.0					°C/W
DC Operating Temperature Range	T_C			-50 to +125					°C
Storage Temperature Range	T_{STG}			-50 to +150					°C

NOTES:

- Unit mounted on 6" x 5.5" x .11" THK (15 cm. x 14 cm. x 0.3 cm.) Al. Plate
- Unit mounted on P.C. Board at .375", (9.5mm) lead lengths.

RATINGS AND CHARACTERISTIC CURVES KBPC6005 THRU KBPC610

FIG. 1 — DERATING CURVE FOR OUTPUT RECTIFIED CURRENT

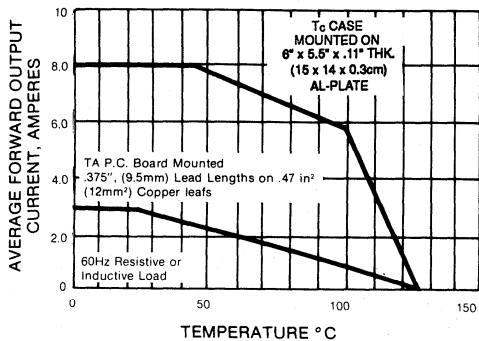

FIG. 2 — MAXIMUM NON-REPETITIVE PEAK FORWARD SURGE CURRENT

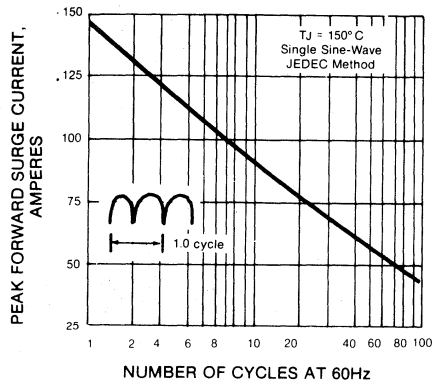

FIG. 3 — TYPICAL INSTANTANEOUS FORWARD CHARACTERISTICS PER ELEMENT

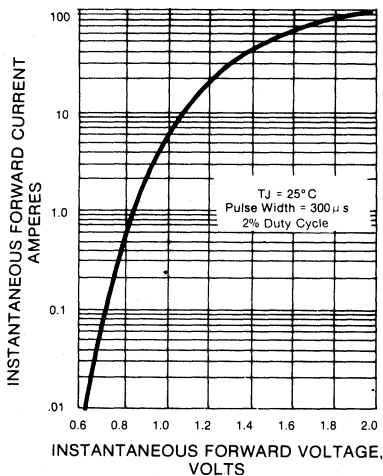
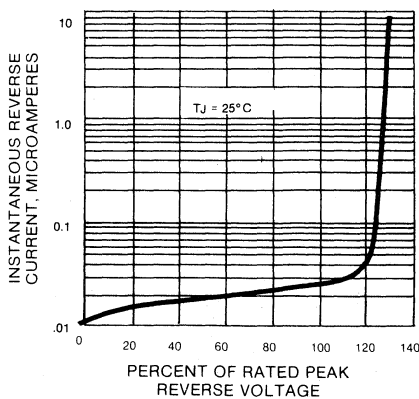

FIG. 4 — TYPICAL REVERSE CHARACTERISTICS PER ELEMENT



KBPC8005 THRU KBPC810

GLASS PASSIVATED SINGLE - PHASE SILICON BRIDGE RECTIFIER
VOLTAGE - 50 to 1000 Volts CURRENT - 8.0 Amperes

FEATURES

- ◆ This series is UL recognized under component index, file number E54214
- ◆ High temperature metallurgically bonded
- ◆ Glass passivated cavity-free rectifier junctions
- ◆ Plastic material used carries Underwriters Laboratory Flammability Classification 94V-O
- ◆ Typical I_R less than $0.1 \mu A$
- ◆ High temperature soldering guaranteed: $265^\circ C / 10$ seconds / $.375"$, (9.5mm) lead length / 5lbs., (2.3 kg) tension

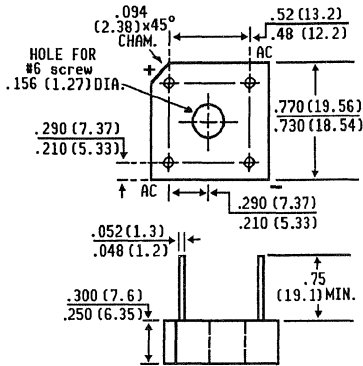

Polarity shown on side of case:
 positive lead by beveled corner

Dimensions in inches
 and
 (millimeters)

MECHANICAL DATA

Case: Void-free plastic package

Terminals: Leads, solderable per MIL-STD-202, Method 208

Mounting: Thru hole for #6 screw

Mounting Position: Any

Weight: 0.24 ounce, 6.9 gram

MAXIMUM RATINGS AND ELECTRICAL CHARACTERISTICS

Ratings at $25^\circ C$ ambient temperature unless otherwise specified.
 Resistive or inductive load, 60 Hz.,
 For capacitive load, derate current by 20%.

	SYMBOLS	KBPC 8005	KBPC 801	KBPC 802	KBPC 804	KBPC 806	KBPC 808	KBPC 810	UNITS
Maximum Recurrent Peak Reverse Voltage	V_{RRM}	50	100	200	400	600	800	1000	Volts
Maximum RMS Voltage	V_{RMS}	35	70	140	280	420	560	700	Volts
Maximum DC Blocking Voltage	V_{DC}	50	100	200	400	600	800	1000	Volts
Maximum Average Forward Rectified Output Current at $T_C = 50^\circ C$ (Note 1) $T_A = 40^\circ C$ (Note 2)	$I_{(AV)}$	8.0			3.0				Amps
Peak Forward Surge Current Single sine-wave superimposed on rated load (JEDEC Method)	I_{FSM}				125				Amps
Maximum Instantaneous Forward Voltage drop per element at 3.0A	V_F				1.2				Volts
Maximum DC Reverse Leakage at Rated DC Blocking Voltage $T_A = 25^\circ C$ $T_C = 125^\circ C$	I_R				10.0				μA
Typical Junction Capacitance per element (Note 3)	C_J				30.0				pf
Typical Thermal Resistance (Note 4)	$R_{\theta JC}$				6.0				$^\circ C/W$
Operating and Storage Temperature Range	T_J, T_{STG}				-50 to +150				$^\circ C$

NOTES:

1. Unit mounted on $8.7" \text{ sq.} \times 24" \text{ THK}$ ($22 \text{ cm. sq.} \times 0.6 \text{ cm}$) Al Plate.
2. Unit mounted P.C. board at $.375"$, 9.5mm lead lengths.
3. Measured at 1 MHz and applied reverse voltage of 4.0 Volts.
4. Thermal Resistance from Junction to Case with units mounted on a $8.6" \times 8.6" \times .24" \text{ THK}$ ($22 \times 22 \times 0.6 \text{ cm}$).

RATINGS AND CHARACTERISTIC CURVES KBPC8005 THRU KBPC810

FIG. 1 — DERATING CURVE FOR OUTPUT RECTIFIED CURRENT

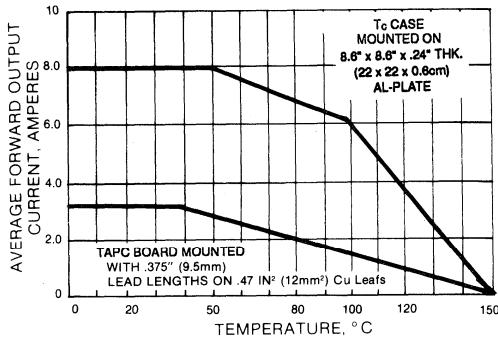

FIG. 3 — TYPICAL INSTANTANEOUS FORWARD CHARACTERISTICS PER ELEMENT

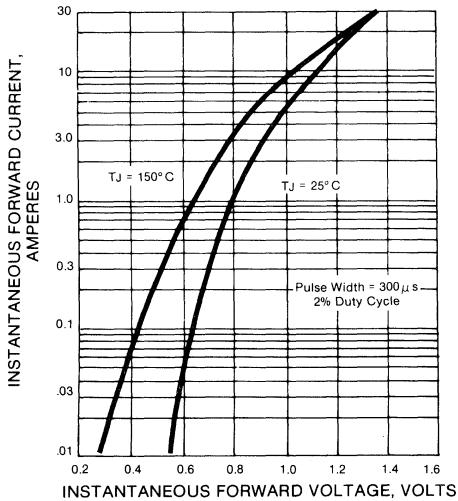

FIG. 2 — MAXIMUM NON-REPETITIVE PEAK FORWARD SURGE CURRENT

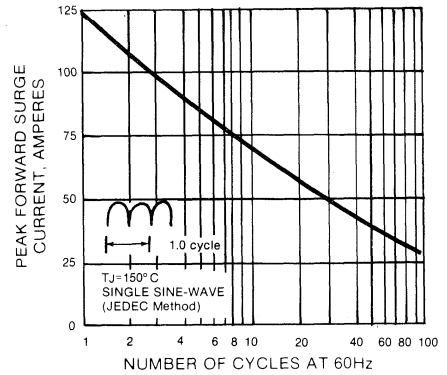

FIG. 4 — TYPICAL JUNCTION CAPACITANCE PER ELEMENT

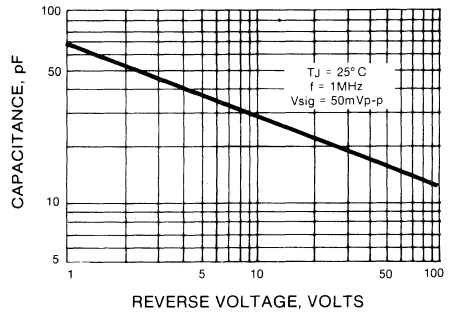
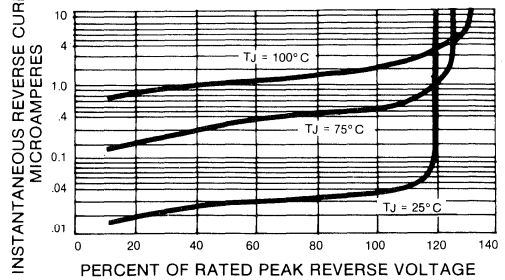

FIG. 5 — TYPICAL REVERSE CHARACTERISTICS



KBU8A THRU KBU8M

SINGLE - PHASE SILICON BRIDGE RECTIFIERS
VOLTAGE - 50 to 1000 Volts CURRENT - 8.0 Amperes

FEATURES

- ◆ This series is UL recognized under component index, file number E54214
- ◆ Plastic material used carries Underwriters Laboratory Flammability Classification 94V-O
- ◆ Ideal for printed circuit board
- ◆ Reliable low cost construction utilizing molded plastic technique
- ◆ Surge overload rating of 300 Amperes peak
- ◆ High temperature soldering guaranteed: 250° C / 10 seconds / .375", (9.5mm) lead length / 5lbs., (2.3 kg) tension

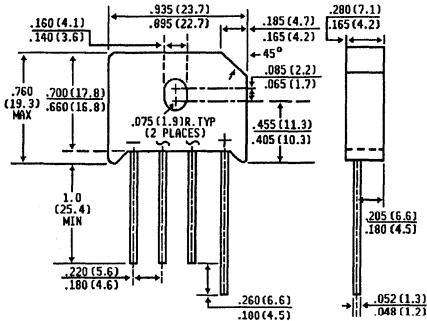
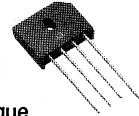

*Dimensions in inches
and
(millimeters)*

MECHANICAL DATA

Case: Reliable low cost construction utilizing molded plastic technique

Terminals: Plated Leads solderable per MIL-STD-202, Method 208

Mounting Position: Any

Mounting Torque: 5 in. lb. max.

Weight: 0.3 ounce, 8.0 gram

MAXIMUM RATINGS AND ELECTRICAL CHARACTERISTICS

Ratings at 25°C ambient temperature unless otherwise specified
 Resistive or inductive load, 60 Hz.,
 For capacitive load, derate current by 20%

		KBU 8A	KBU 8B	KBU 8D	KBU 8G	KBU 8J	KBU 8K	KBU 8M	UNITS
Maximum Recurrent Peak Reverse Voltage	V _{RRM}	50	100	200	400	600	800	1000	Volts
Maximum RMS Voltage	V _{RMS}	35	70	140	280	420	560	700	Volts
Maximum DC Blocking Voltage	V _{DC}	50	100	200	400	600	800	1000	Volts
Maximum Average Forward Rectified Output Current at	I <sub(av)< sub=""></sub(av)<>				8.0 6.0				Amps
Peak Forward Surge Current Single sine-wave superimposed on rated load (JEDEC Method)	I _{FSM}				300				Amps
Maximum Instantaneous Forward Voltage drop per element at 8.0A	V _F				1.0				Volts
Maximum DC Reverse Leakage at Rated DC Blocking Voltage per element	I _R				10.0 300				µA
Typical Thermal Resistance (Note 1)	R _{ΘJC}				5.0				°C/W
Operating and Storage Temperature Range	T _J , T _{STG}				-50 to +150				°C

NOTES:

1. Thermal Resistance from Junction to Case with units mounted on a 3" x .11" THK (7.5cm. sq. x 0.3 cm.) Al. Plate*

RATINGS AND CHARACTERISTIC CURVES KBU8A THRU KBU8M

FIG. 1 — DERATING CURVE FOR OUTPUT RECTIFIED CURRENT

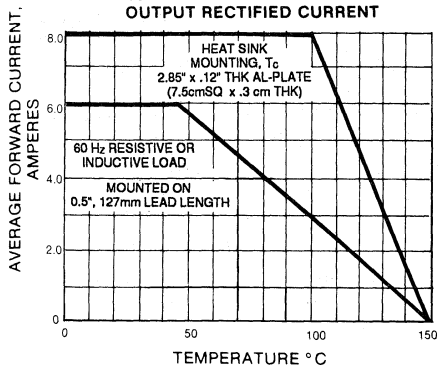

FIG. 3 — TYPICAL REVERSE CHARACTERISTICS

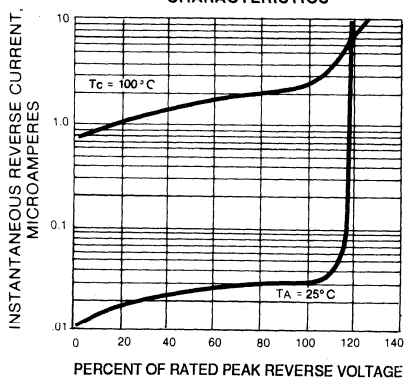

FIG. 5 — TYPICAL JUNCTION CAPACITANCE PER ELEMENT

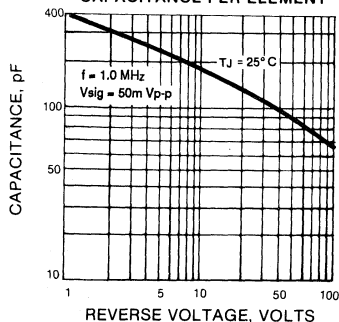

FIG. 2 — TYPICAL INSTANTANEOUS FORWARD CHARACTERISTICS PER ELEMENT

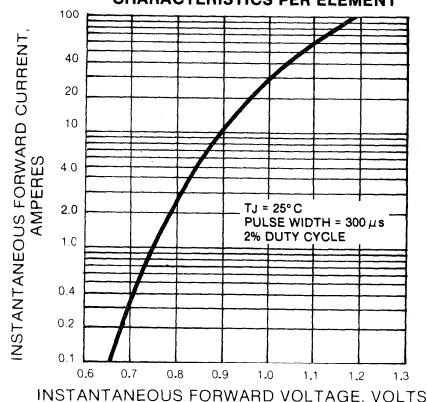
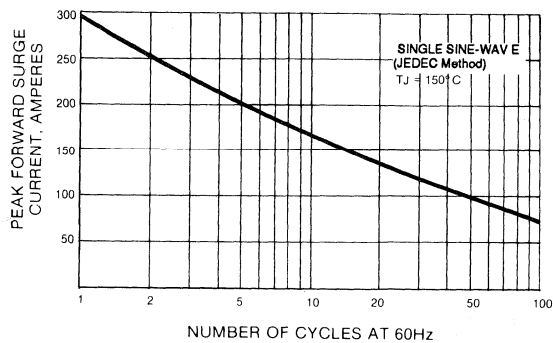

FIG. 4 — MAXIMUM NON-REPETITIVE PEAK FORWARD SURGE CURRENT



KBPC10, 15,25,35 SERIES

HIGH CURRENT SINGLE - PHASE SILICON BRIDGE RECTIFIERS

FEATURES

KBPC STANDARD

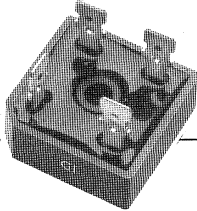

- ◆ This series is UL recognized under component index, file number E54214
- ◆ The plastic material used carries Underwriters Laboratory flammability recognition 94V-O
- ◆ Integrally molded heatsink provide very low thermal resistance for maximum heat dissipation
- ◆ Universal 4-way terminals; snap-on, wrap-around, solder or P.C. board mounting
- ◆ Surge overload ratings to 400 Amperes
- ◆ Terminals solderable per MIL-STD-202, Method 208
- ◆ Typical I_R less than $0.1 \mu A$
- ◆ High temperature soldering guaranteed: $250^\circ C / 10$ seconds / .375", (9.5mm) lead length / 5lbs., (2.3 kg) tension

KBPC-W WIRE LEADS

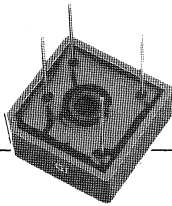

Case: Molded plastic with heatsink integrally mounted in the bridge encapsulation

Terminals: Either plated .25" (6.35mm). Faston or plated copper leads .040" (1.02mm) diameter. Suffix letter "W" added to indicate leads

Weight: .706 ounce, 20 gram

Mounting Position: Bolt down on heat-sink with silicone thermal compound between bridge and mounting surface for maximum heat transfer efficiency

Mounting Torque: 20 in. lb. max.

Polarity: Polarity symbols molded on body

MECHANICAL DATA

MAXIMUM RATINGS AND ELECTRICAL CHARACTERISTICS

Ratings at $25^\circ C$ ambient temperature unless otherwise specified. 60 Hz, resistive or inductive load. For capacitive load, derate current by 20%.

			-005	-01	-02	-04	-06	-08	-10	
Maximum Recurrent Peak Reverse Voltage		V_{RRM}	50	100	200	400	600	800	1000	Volts
Maximum RMS Voltage		V_{RMS}	35	70	140	280	420	560	700	Volts
Maximum DC Blocking Voltage		V_{DC}	50	100	200	400	600	800	1000	Volts
Maximum Average Forward Rectified Output Current at $T_c = 55^\circ C$	KBPC10 KBPC15 KBPC25 KBPC35	$I_{(AV)}$				10.0 15.0 25.0 35.0				Amps
Peak Forward Surge Current Single sine-wave superimposed on rated load (JEDEC Method)	KBPC10 KBPC15 KBPC25 KBPC35	I_{FSM}				200 300 300 400				Amps
Rating (non-repetitive, for t greater than 1 ms and less than 8.3 ms) For Fusing	KBPC10 KBPC15 KBPC25 KBPC35	I^2t				160 375 375 660				A^2s
Maximum Instantaneous Forward Voltage drop per element at specified current	KBPC10 5.0A KBPC15 7.5A KBPC25 12.5A KBPC35 17.5A	V_F				1.2				Volts
Isolation Voltage from case to leads						2500				V_{ac}
Maximum Reverse DC Current at Rated DC Blocking Voltage per element		I_R				10.0				μA
Typical Thermal Resistance (Note 1)		$R_{\theta JC}$				2.0				$^\circ C/W$
Operating and Storage Temperature Range,		T_J, T_{STG}				-50 to +150				$^\circ C$

NOTES: 1. Thermal Resistance from Junction to Case.

RATINGS AND CHARACTERISTIC CURVES KBPC 10,15,25,35 SERIES

FIG. 1

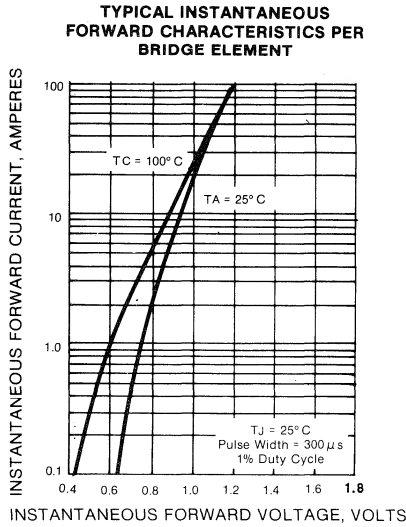

FIG. 2

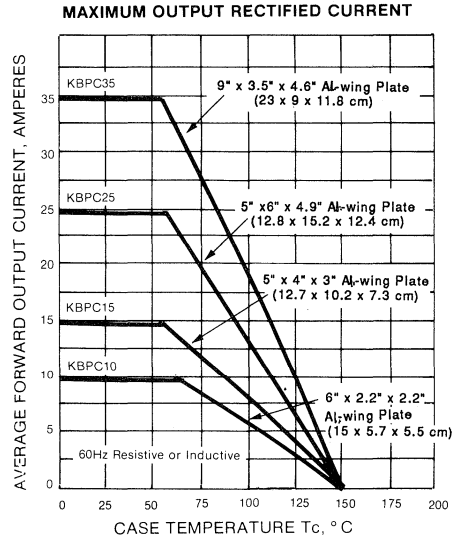

FIG. 3

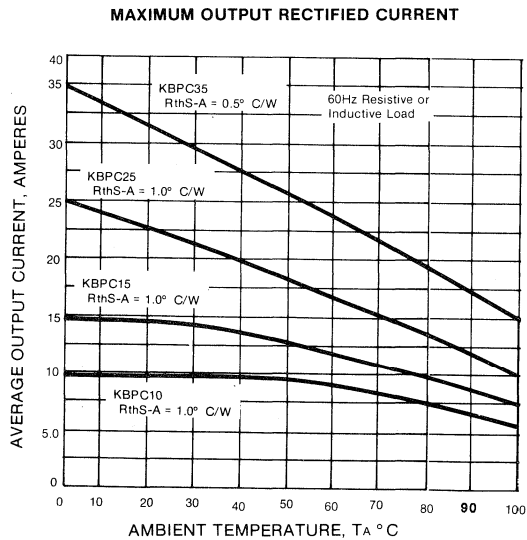
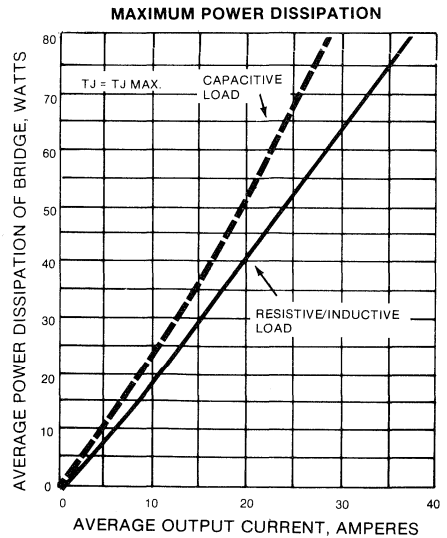

FIG. 4



RATINGS AND CHARACTERISTIC CURVES KBPC 10,15,25,35 SERIES

FIG. 5

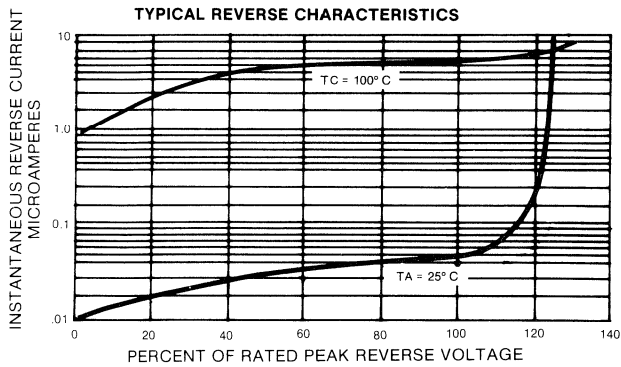

FIG. 6

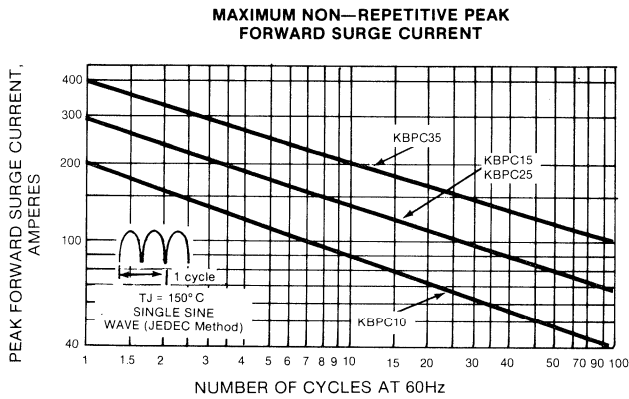
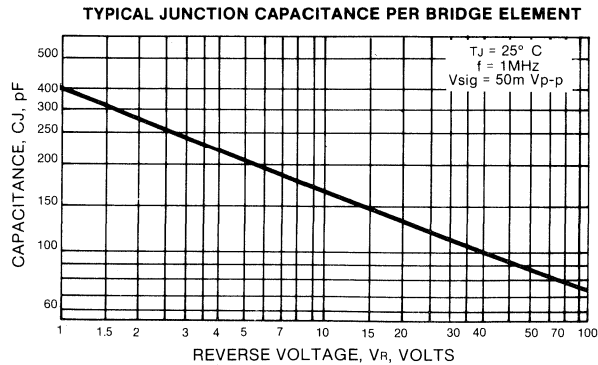
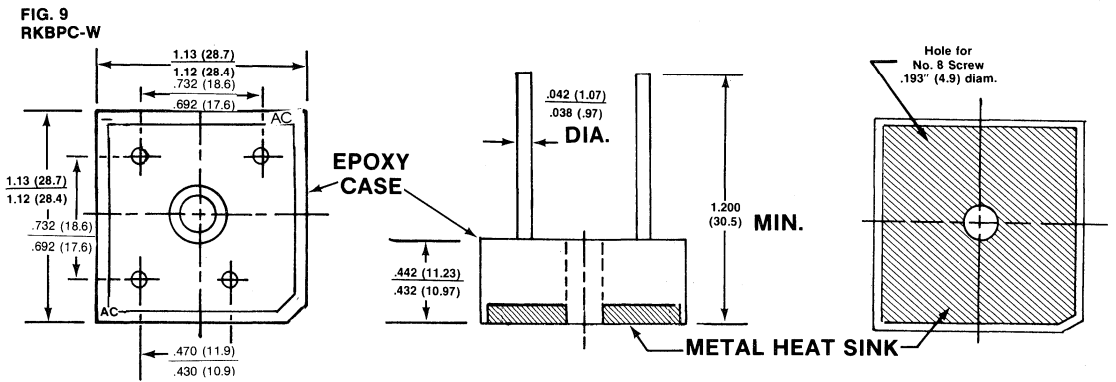
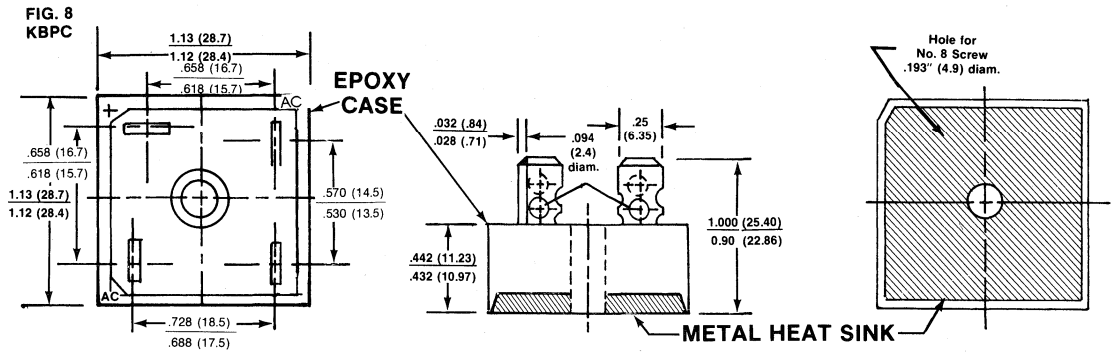

FIG. 7





NOTES:

1. Corrosion resistant terminals designed for .250 female quick connector, wrap around or solder.
 2. A thin film of silicone thermal compound is recommended between the bridge case and mounting surface for improved thermal conduction.
 3. Higher dielectric strengths available. Consult factory.
 4. These bridges are also available in fast recovery and in positive and negative center tap and in doubler configurations. Consult Factory.
- Dimensions in inches and (millimeters).

RDF005M THRU RDF08M

MINIATURE FAST RECOVERY GLASS PASSIVATED SILICON BRIDGE
VOLTAGE - 50 to 800 Volts CURRENT - 1.0 Ampere

FEATURES

- ◆ This series is UL recognized under component index, file number E54214
- ◆ Plastic material used carries Underwriters Laboratory flammability recognition 94V-O
- ◆ Glass passivated chip junctions
- ◆ Surge overload rating - 50 amperes peak
- ◆ Ideal for printed circuit board
- ◆ High temperature soldering guaranteed: 265° C /10 seconds at 5 lbs., (2.3kg) tension
- ◆ Fast switching for high efficiency

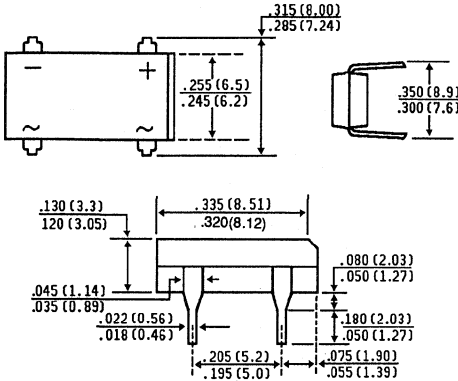

Dimensions in inches
and
(millimeters)

MECHANICAL DATA

Case: Reliable low cost construction utilizing molded plastic technique results in inexpensive product

Terminals: Lead solderable per MIL-ST-202, Method 208

Polarity: Polarity symbols marked on body

Weight: 0.04 ounce, 1.0 gram

Mounting Position: Any

MAXIMUM RATINGS AND ELECTRICAL CHARACTERISTICS

Ratings at 25°C ambient temperature unless otherwise specified.
60 Hz, resistive or inductive load. For capacitive load, derate current by 20%.

	SYMBOLS	RDF 005M	RDF 01M	RDF 02M	RDF 04M	RDF 06M	RDF 08M	UNITS
Maximum Recurrent Peak Reverse Voltage	V _{RRM}	50	100	200	400	600	800	Volts
Maximum RMS Voltage	V _{RMS}	35	70	140	280	420	560	Volts
Maximum DC Blocking Voltage	V _{DC}	50	100	200	400	600	800	Volts
Maximum Average Forward Output Rectified Current at T _A = 40°C	I _(AV)	1.0						Amps
Peak Forward Surge Current Single sine-wave superimposed on rated load (JEDEC Method)	I _{FSM}	50						Amps
Rating for fusing (t < 8.35ms)	I ² t	10.0						A ² s
Maximum Instantaneous Forward Voltage drop per Bridge Element at 1.0A	V _F	1.3						Volts
Maximum Reverse Current at Rated DC Blocking Voltage	I _R	10.0 1.0						μA mA
Maximum Reverse Recovery Time (Note 1) T _J = 25°C	T _{RR}	200			350			Ns
Typical Thermal Resistance (Note 2)	R _{θJA}	40.0						°C/W
Operating and Storage Temperature Range,	T _J , T _{STG}	-55 to +150						°C

NOTES:

1. Reverse Recovery Test Conditions: I_F = 0.5A, I_R = 1.0A, I_{rr} = .25A.
2. Thermal Resistance from Junction to Ambient mounted on P.C. Board with .51"sq. (13mm sq.) Copper Pads.

RATINGS AND CHARACTERISTIC CURVES RDF005M THRU RDF08M

FIG. 1 — DERATING CURVE FOR OUTPUT RECTIFIED CURRENT

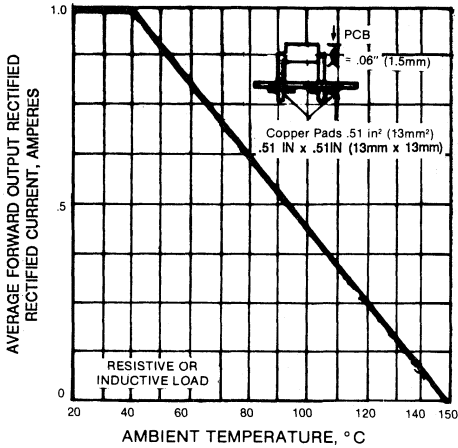

FIG. 2 — TYPICAL FORWARD CHARACTERISTICS PER ELEMENT

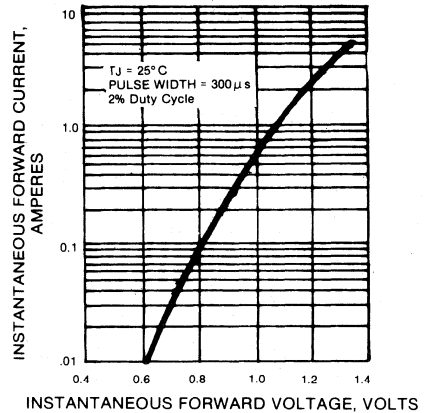

FIG. 3 — MAXIMUM FORWARD SURGE CURRENT

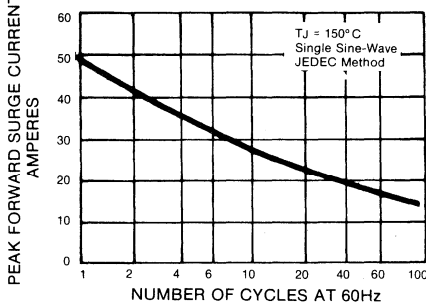

FIG. 4 — TYPICAL REVERSE CHARACTERISTICS

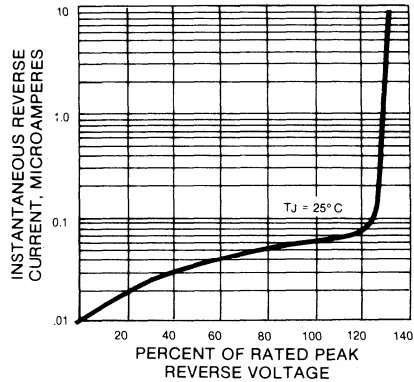

FIG. 5 — TYPICAL JUNCTION CAPACITANCE PER BRIDGE ELEMENT

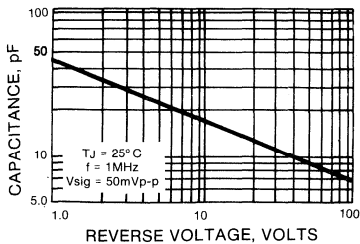
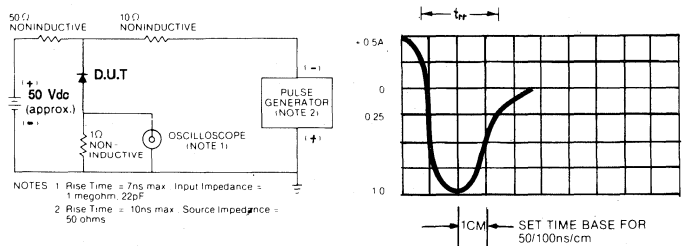

FIG. 6 — REVERSE RECOVERY TIME CHARACTERISTIC AND TEST CIRCUIT DIAGRAM



RW005G THRU RW08G

**MINIATURE FAST RECOVERY GLASS PASSIVATED
SINGLE - PHASE SILICON BRIDGE RECTIFIER**
VOLTAGE - 50 to 800 Volts CURRENT - 1.5 Amperes

FEATURES

- ◆ Glass passivated chip junctions
- ◆ Plastic material used carries Underwriters Laboratory flammability recognition 94V-O
- ◆ High case dielectric strength
- ◆ Typical I_R less than 0.1 μ A
- ◆ Fast switching for high efficiency
- ◆ High overload surge capability
- ◆ Ideal for printed circuit board
- ◆ High temperature soldering guaranteed: 265° C/10 seconds / .375", (9.5mm) lead length/5lbs., (2.3 kg) tension

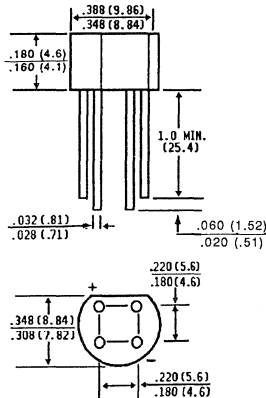
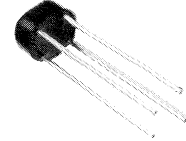

Dimensions in inches and (millimeters)

MECHANICAL DATA

Case: Molded plastic

Terminals: Leads solderable per MIL-STD-202, Method 208

Mounting Position: Any

Weight: 0.04 ounce, 1.1 gram

MAXIMUM RATINGS AND ELECTRICAL CHARACTERISTICS

Ratings at 25°C ambient temperature unless otherwise specified.
60 Hz, resistive or inductive load.

	SYMBOLS	RW 005G	RW 01G	RW 02G	RW 04G	RW 06G	RW 08G	UNITS
Maximum Recurrent Peak Reverse Voltage	VRRM	50	100	200	400	600	800	Volts
Maximum RMS Voltage	VRRMS	35	70	140	280	420	560	Volts
Maximum DC Blocking Voltage	VDC	50	100	200	400	600	800	Volts
Maximum Average Forward Rectified Current at .375", (9.5mm) lead length at $T_A = 25^\circ\text{C}$	$I_{(AV)}$	1.5						Amps
Peak Forward Surge Current Single sine-wave superimposed on rated load (JEDEC Method)	I_{FSM}	50.0						Amps
Rating for fusing ($t < 8.3\text{ms}$)	I^2t	10.0						A^2s
Maximum Instantaneous Forward Voltage Drop per element at 1.0 Amperes	V_F	1.3						Volts
Maximum DC Reverse Current at Rated $T_A = 25^\circ\text{C}$ DC Blocking Voltage per Bridge Element $T_A = 125^\circ\text{C}$	I_R	500						μA
Typical Junction Capacitance per element (Note 1)	C_J	25.0						pf
Maximum Reverse Recovery Time per element (Note 3) $T_J = 25^\circ\text{C}$	T_{RR}	200				350		ns
Typical Thermal Resistance (Note 2)	$R_{\theta JA}$	36.0						$^\circ\text{C}/\text{W}$
Maximum DC Operating Temperature Range	T_A	-55 to +150			-55 to +125			$^\circ\text{C}$
Storage Temperature Range	T_{STG}	-55 to +150			-55 to +125			$^\circ\text{C}$

NOTES:

1. Measured at 1.0 MHz and applied reverse voltage of 4.0 Volts.
2. Thermal Resistance from Junction to Ambient at .375", 9.5mm lead length P.C. Board mounting.
3. Reverse Recovery Test Conditions: $I_F = 0.5\text{A}$, $I_R = 1.0\text{A}$, $I_{rr} = 0.25\text{A}$.

RATINGS AND CHARACTERISTIC CURVES RW005G THRU RW08G

**FIG. 1 - DERATING CURVE
OUTPUT RECTIFIED CURRENT**

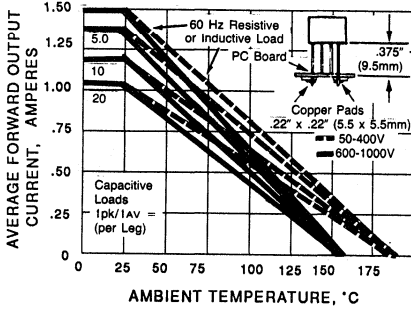

**FIG. 2 - MAXIMUM NON-REPETITIVE
PEAK FORWARD SURGE CURRENT**

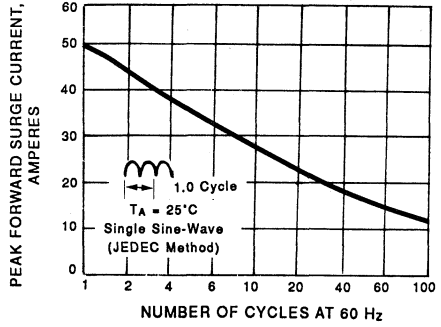

**FIG. 3 - TYPICAL
REVERSE CHARACTERISTICS**

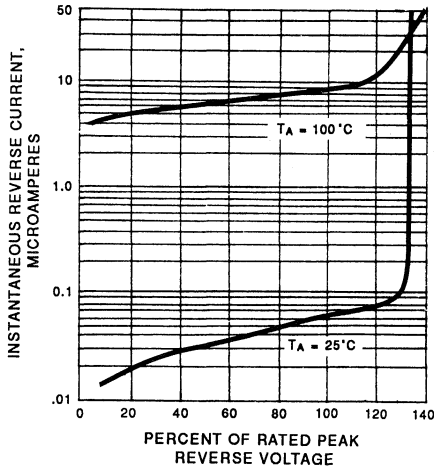

**FIG. 4 - TYPICAL FORWARD
CHARACTERISTICS PER ELEMENT**

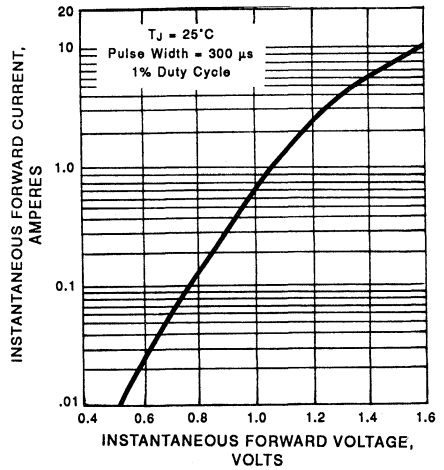

**FIG. 5 - TYPICAL JUNCTION CAPACITANCE
PER BRIDGE ELEMENT**

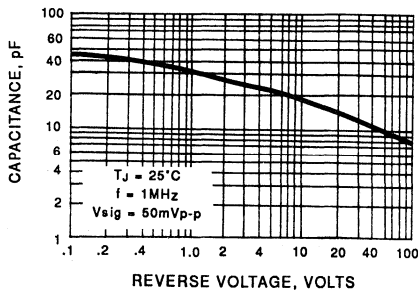

**FIG. 6 - TYPICAL TRANSIENT
THERMAL IMPEDANCE**

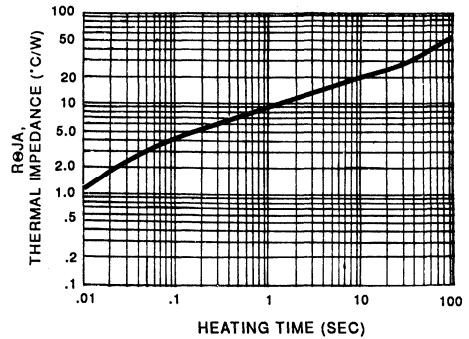

EDF1AM THRU EDF1DM

MINIATURE GLASS PASSIVATED FAST EFFICIENT SILICON BRIDGE

VOLTAGE - 50 to 200 Volts CURRENT - 1.0 Ampere

FEATURES

- ◆ This series is UL recognized under component index, file number E54214
- ◆ Plastic material used carries Underwriters Laboratory flammability recognition 94V-0
- ◆ Glass passivated chip junctions
- ◆ Surge overload rating - 50 amperes peak
- ◆ Ideal for printed circuit board
- ◆ High temperature soldering guaranteed: 265° C /10 seconds at 5 lbs., (2.3kg) tension
- ◆ Superfast recovery times for high efficiency

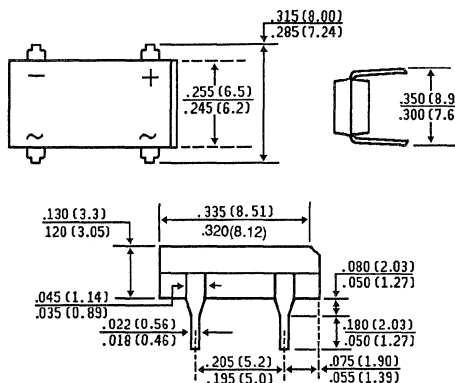

Dimensions in inches
and
(millimeters)

MECHANICAL DATA

Case: Reliable low cost construction utilizing molded plastic technique results in inexpensive product

Terminals: Lead solderable per MIL-ST-202, Method 208

Polarity: Polarity symbols marked on body

Weight: 0.04 ounce, 1.0 gram

Mounting Position: Any

MAXIMUM RATINGS AND ELECTRICAL CHARACTERISTICS

Ratings at 25°C ambient temperature unless otherwise specified.
60 Hz, resistive or inductive load. For capacitive load, derate current by 20%.

	SYMBOLS	EDF1AM	EDF1BM	EDF1CM	EDF1DM	UNITS
Maximum Recurrent Peak Reverse Voltage	V _{RRM}	50	100	150	200	Volts
Maximum RMS Voltage	V _{RMS}	35	70	150	200	Volts
Maximum DC Blocking Voltage	V _{DC}	50	100	150	200	Volts
Maximum Average Forward Output Rectified Current at T _A = 40°C	I _(AV)	1.0				Amps
Peak Forward Surge Current Single half sine-wave superimposed on rated load (JEDEC Method)	I _{FSM}	50				Amps
Rating for fusing (t < 8.35ms)	I ² t	10.0				A ² s
Maximum Instantaneous Forward Voltage drop per Bridge Element at 1.0A	V _F	1.05				Volts
Maximum Reverse Current at Rated DC Blocking Voltage	I _R	5.0				μA
		1.0				mA
Maximum Reverse Recovery Time (Note 1) T _J = 25°C	T _{RR}	50.0				ns
Typical Thermal Resistance (Note 2)	RθJA	40.0				°C/W
Operating and Storage Temperature Range,	T _J , T _{STG}	-55 to +150				°C

NOTES:

1. Reverse Recovery Test Conditions: I_F = 0.5A, I_R = 1.0A, I_{rr} = .25A.
2. Thermal Resistance from Junction to Ambient mounted on P.C. Board with .51"sq. (13mm sq.) Copper Pads.

RATINGS AND CHARACTERISTIC CURVES EDF1AM THRU EDF1DM

FIG. 1 — DERATING CURVE FOR OUTPUT RECTIFIED CURRENT

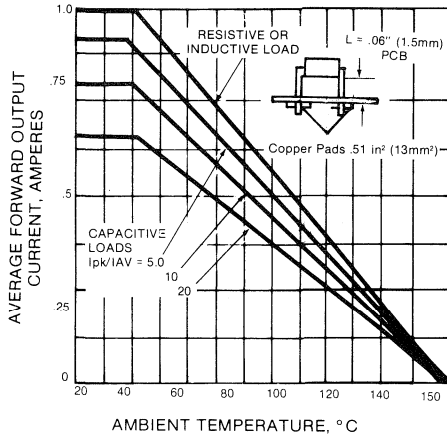

FIG. 3 - TYPICAL REVERSE CHARACTERISTICS PER BRIDGE ELEMENT

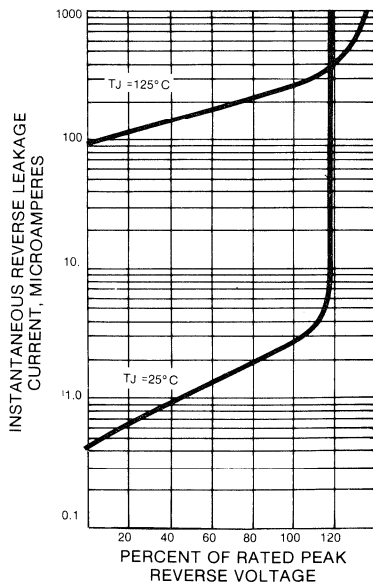

FIG. 2 — MAXIMUM NON-REPETITIVE PEAK FORWARD SURGE CURRENT

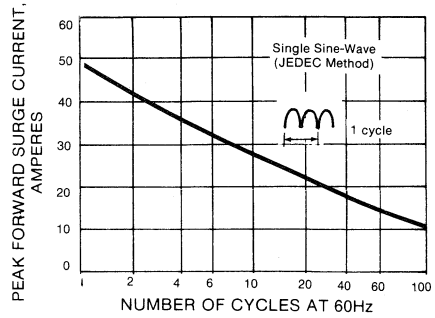

FIG. 4 — TYPICAL FORWARD CHARACTERISTICS PER BRIDGE ELEMENT

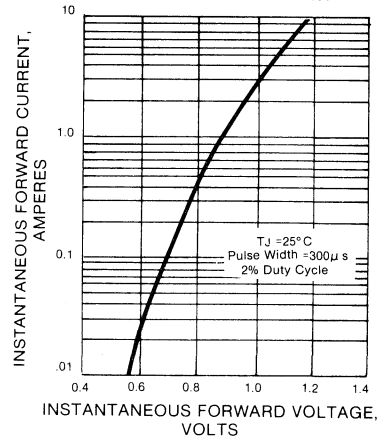
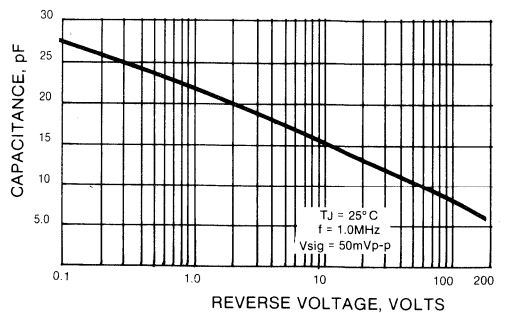

FIG. 5 — TYPICAL JUNCTION CAPACITANCE PER BRIDGE ELEMENT



**SURFACE MOUNT
BRIDGE RECTIFIER**

***1.0 AMPERE
50 VOLTS TO 1000 VOLTS***

**GENERAL
INSTRUMENT**

DF005S THRU DF10S

**MINIATURE GLASS PASSIVATED SINGLE-PHASE
SILICON SURFACE MOUNT BRIDGE**
VOLTAGE - 50 to 1000 Volts CURRENT - 1.0 Ampere

FEATURES

- ◆ This series is UL recognized under component index file number E54214
- ◆ Plastic material used carries Underwriters Laboratory recognition 94V-0
- ◆ Glass passivated chip- junctions
- ◆ Surge overload rating - 50 amperes peak
- ◆ Ideal for printed circuit board
- ◆ High temperature soldering guaranteed 300°C/10 seconds at 5 lbs., (2.3kg) tension

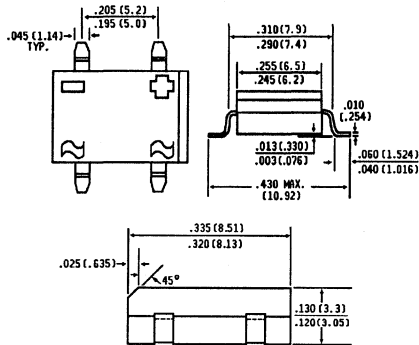

Dimensions in inches
and
(millimeters)

MECHANICAL DATA

Case: Molded Plastic

Terminals: Lead solderable per MIL-STD-202, Method 208

Polarity: Polarity symbols marked on body

Weight: 0.04 ounce, 1.0 gram

Mounting Position: Any

MAXIMUM RATINGS AND ELECTRICAL CHARACTERISTICS

Ratings at 25°C ambient temperature unless otherwise specified.
60 Hz, resistive or inductive load.

	SYMBOLS	DF0 05S	DF 01S	DF 02S	DF 04S	DF 06S	DF 08S	DF 10S	UNITS
Maximum Recurrent Peak Reverse Voltage	V _{RRM}	50	100	200	400	600	800	1000	Volts
Maximum RMS Voltage	V _{RMS}	35	70	140	280	420	560	700	Volts
Maximum DC Blocking Voltage	V _{DC}	50	100	200	400	600	800	1000	Volts
Maximum Average Forward Output Rectified Current at T _A = 40°C	I <sub(av)< sub=""></sub(av)<>	1.0							Amp
Peak Forward Surge Current Single half sine-wave superimposed on rated load (JEDEC Method)	I _{FSM}				50.0				Amps
Rating for fusing (t < 8.35ms)	I ² t				10.0				A ² s
Maximum Instantaneous Forward Voltage drop per element at 1.0A	V _F				1.1				Volts
Maximum Reverse Current T _A = 25°C at Rated DC Blocking Voltage per element T _A = 125°C	I _R				10.0				μA mA
Typical Junction Capacitance per element (Note 1)	C _J				25.0				pf
Operating Temperature Range	T _J				-55 to +150				°C
Storage Temperature Range,	T _{STG}				-55 to +150				°C

NOTE:

1. Measured at 1.0 MHz and applied reverse voltage of 4.0 Volts.

RATINGS AND CHARACTERISTIC CURVES DF005S THRU DF10S

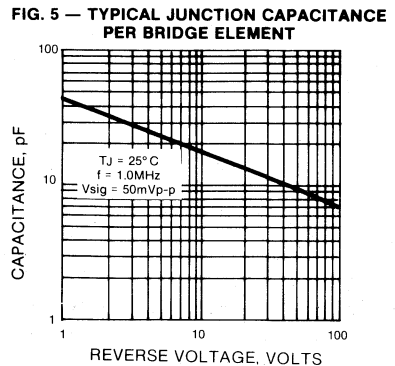
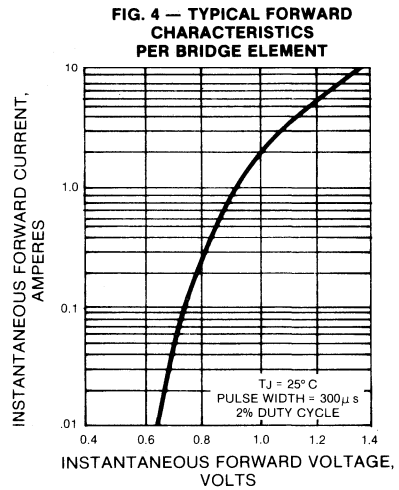
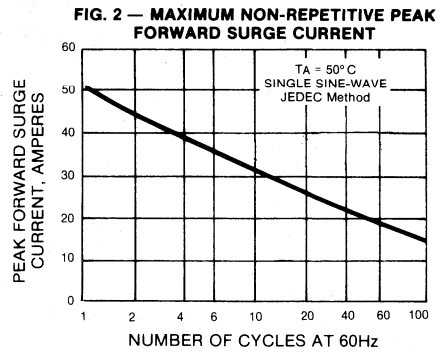
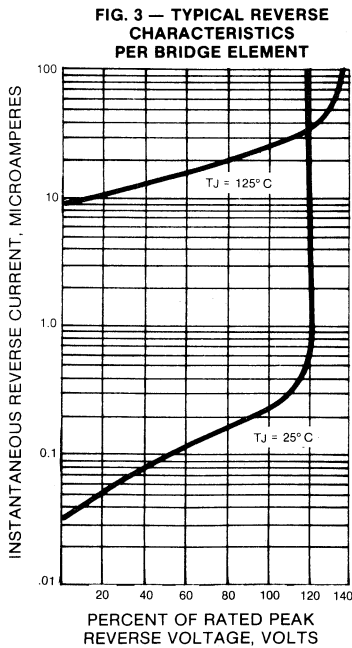
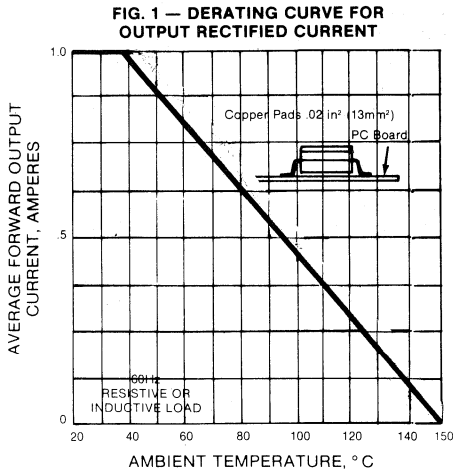

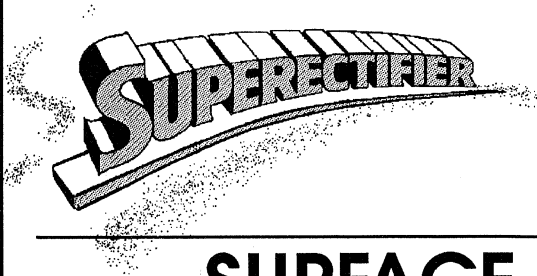

SURFACE MOUNT SUPERECTIFIERS

GENERAL
INSTRUMENT

SUPERECTIFIER®

SURFACEMOUNT®

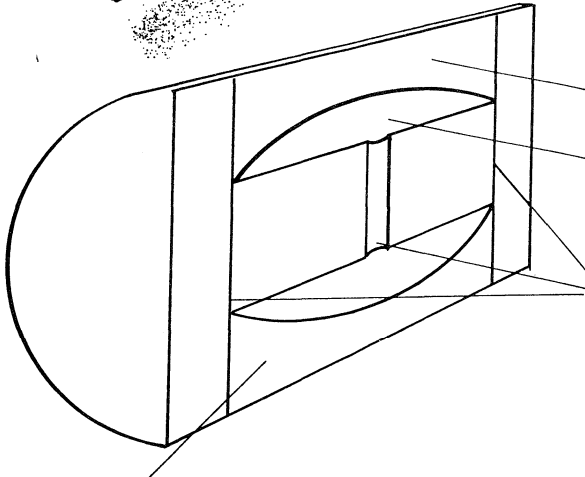

COMPLETELY ENCAPSULATED
BRAZED CONSTRUCTION

CAVITY-FREE OPAQUE GLASS-
PASSIVATED JUNCTION

SOLID BRAZING. LOW RESISTANCE.
EXCELLENT SURGE CAPABILITIES
BRAZED-TEMP > 600°C

UL RECOGNIZED
FLAME-RETARDANT
MOLDING COMPOUND (UL 94V-0)

PATENTED*

* Glass-plastic encapsulation technique is covered by Patent No. 3,996,602 of 1976; brazed-lead assembly to Patent No. 3,930,306 of 1976 and glass composition by Patent No. 3,752,701 of 1973

Our surface mount SUPERECTIFIER has redefined the concept of time and space. Passivated silicon SUPERECTIFIERS (IN6478-IN6484 and GL41A-GL41M) are 1 amp, 50-1000 PRV, leadless, surface mounted devices that provide new space options, from increased surface density to reduced board size. Component placement speeds can be an order of magnitude higher. Our surface mount SUPERECTIFIERS feature:

Brazing at greater than 600°C at both terminal and cell—eliminates all soft solders

Exclusive UL recognized flame-retardant epoxy molding compound rated 94V-0, the highest available **rating**. (hermetically sealed construction.)

No other 1 Ampere rectifier of any kind - plastic, glass or metal—can match our surface mount SUPERECTIFIER features.

The way we make our surface mount SUPERECTIFIER is what makes them the best.

In cell construction, most other rectifiers rated up to 1 Ampere are soldered or are only pressure contacted. Our surface mounted SUPERECTIFIER is made into an entirely solid unit with leads and cell brazed at temperatures greater than 600°C. All other rectifiers fail at half that temperature!

Conventional plastic rectifiers use either varnish, silicone rubber or a thin film of silicon oxide to protect the junction. Our surface mount SUPERECTIFIER uses a patented glass passivation to seal its junction hermetically.

In device encapsulation, our surface mount SUPERECTIFIER uses a flame-RETARDANT molding compound, rated UL 94V-0, the highest rating available. In fact, it is the only plastic rectifier that exceeds environmental standards of MIL-S-19500.

In summary, the General Instrument surface mount SUPERECTIFIER is the world's only rectifier with totally brazed construction, with a patented glass passivated junction, and with flame-retardant molding encapsulation.

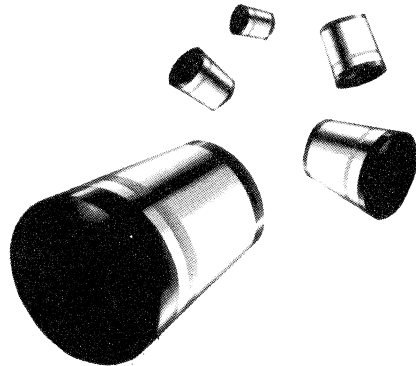

GENERAL INSTRUMENT

SURFACE MOUNT SUPERRECTIFIERS

Surface Mount Superectifiers

Features:

- High Temperature Metallurgically Bonded
- Plastic Package has Underwriters Laboratory Classification 94V-0
- Glass Passivated Junction
- Exceeds Environmental Standards of MIL-STD-19500
- High Temperature Soldering Guaranteed for all present methods, including wave and vapor reflow soldering

Types:

1N6478-1N6484 1 amp, Standard Recovery Times
 GL41A-GL41M 1 amp, Standard Recovery Times
 RGL41A-RGL41M 1 amp, Fast Recovery Times
 EGL41A-EGL41G 1 amp, Ultrafast Recovery Times
 GL34A-GL34J 0.5 amp., Standard Recovery Times
 RGL34A-RGL34J 0.5 amp., Fast Recovery Times
 EGL34 - EGB4G 0.5 amp Ultrafast Recovery Times

Quick Guide To Surface Mount Superectifiers

TYPE	1N6478 thru 1N6484	GL41A thru GL41M	RGL41A* thru RGL41M*	EGL41+ thru EGL41G+	GL34A thru GL34J	RGL34A thru RGL34J	EGL34A thru EGL34G
CASE	GL41	GL41	GL41	GL41	GL34	GL34	GL34
I (A)	1.0	1.0	1.0	1.0	0.5	0.5	0.5
T_J (°C)	75	75	55	75	75	55	75
V. = 50 (V)	1N6478	GL41A	RGL41A	EGL41A	GL34A	RGL34A	EGL34A
V. = 100 (V)	1N6479	GL41B	RGL41B	EGL41B	GL34B	RGL34B	EGL34B
V. = 150 (V)				EGL41C			EGL34C
V. = 200 (V)	1N6480	GL41D	RGL41D	EGL41D	GL34D	RGL34D	EGL34D
V. = 300 (V)				EGL41F			EGL34F
V. = 400 (V)	1N6481	GL41G	RGL41G	EGL41G	GL34G	RGL34G	EGL34G
V. = 600 (V)	1N6482	GL41J	RGL41J		GL34J	RGL34J	
V. = 800 (V)	1N6483	GL41K	RGL41K				
V. = 1000 (V)	1N6484	GL41M	RGL41M				
SURGE (A)	30	30	30	30	10	10	10
V. (V)	1.0	1.1 / 1.2	1.3	1.0/1.25	1.1	1.3	1.25

* Fast Recovery

+ Ultrafast Recovery

Silicon Chips

General Instrument's Silicon Chips are available in a large variety of current and voltage types. Chips with standard, fast, and ultrafast recovery times are available.

Each General Instrument chip is a glass passivated junction which offers easily solderable metallization as well as high surge current capability, making them ideal for hybrid circuit applications.

Types:

GPP 1 and 5 amp, standard recovery times
 RGPP 1 and 5 amp, fast recovery times
 EFR 1, 3, 5, and 8 amp, ultrafast recovery times

TYPE	Standard Recovery		Fast Recovery		Ultrafast Recovery			
	GPP1A thru GPP1M	GPP5A thru GPP5K	RGPP1A thru RGPP1K	RGPP5A thru RGPP5K	EFR1A thru EFR1D	EFR3A thru EFR3D	EFR5A thru EFR5D	EFR8A thru EFR8D
I _r (A)	1.0	5.0	1.0	5.0	1.0	3.0	5.0	8.0
@ T _a (°C)	75	100	75	100	75	75	75	75
V _{rr} = 20 (V)								
V _{rr} = 30 (V)								
V _{rr} = 40 (V)								
V _{rr} = 50 (V)	GPP1A	GPP5A	RGPP1A	RGPP5A	EFR1A	EFR3A	EFR5A	EFR8A
V _{rr} = 60 (V)								
V _{rr} = 100 (V)	GPP1B	GPP5B	RGPP1B	RGPP5B	EFR1B	EFR3B	EFR5B	EFR8B
V _{rr} = 150 (V)					EFR1C	EFR3C	EFR5C	EFR8C
V _{rr} = 200 (V)	GPP1D	GPP5D	RGPP1D	RGPP5D	EFR1D	EFR3D	EFR5D	EFR8D
V _{rr} = 400 (V)	GPP1G	GPP5G	RGPP1G	RGPP5G				
V _{rr} = 600 (V)	GPP1J	GPP5J	RGPP1J	RGPP5J				
V _{rr} = 800 (V)	GPP1K	GPP5K	RGPP1K	RGPP5K				
V _{rr} = 1000 (V)	GPP1M							
SURGE (A)	60	150	30	150	50	75	125	300
V _r (V)	1.1	1.1	1.3	1.3	0.9	0.9	0.9	0.9

BYM05-50 THRU BYM05-600 GL34A THRU GL34J

SURFACE MOUNT GLASS PASSIVATED SILICON RECTIFIER

Voltage - 50 to 600 Volts Current - 0.5 Amperes

FEATURES

- ◆ For surface mounted applications
- ◆ High temperature metallurgically bonded - no compression contacts as found in diode-constructed rectifiers
- ◆ Glass passivated junction
- ◆ Plastic package has Underwriters Laboratory Flammability Classification 94V-0
- ◆ Capable of meeting environmental standards of MIL-S-19500
- ◆ High temperature soldering guaranteed: 450°C/5 seconds at terminals. Complete device submersible temperature of 260°C for 10 seconds in solder bath

PATENTED*

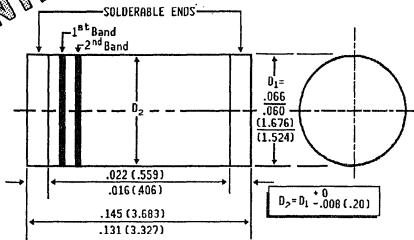

Dimensions in inches and (millimeters)

*Glass-plastic encapsulation technique is covered by Patent No. 3,996,602 of 1976; brazed-lead assembly by Patent No. 3,930,306 of 1976 and glass composition by Patent No. 3,752,701 of 1973.

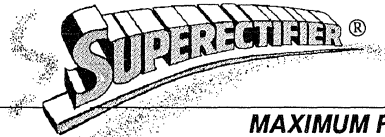

MECHANICAL DATA

- Case:** Molded plastic over glass
Terminals: Plated Terminals, solderable per MIL-STD-202, Method 208
Polarity: Two bands indicate cathode
 1st band denotes device type 2nd band denotes voltage type
Mounting Position: Any **Handling Precautions:** None
Weight: 0.036 gram, 0.0014 ounce

MAXIMUM RATINGS AND ELECTRICAL CHARACTERISTICS

Ratings at 25°C ambient temperature unless otherwise specified. 60 Hz, resistive or inductive load. For capacitive load, derate current by 20%.

	SYMBOLS	BYM05					UNITS
		-50	-100	-200	-400	-600	
Standard recovery time device: 1 st band is white		GL34A	GL34B	GL34D	GL34G	GL34J	
Maximum Recurrent Peak Reverse Voltage	V _{RRM}	50	100	200	400	600	Volts
Maximum RMS Voltage	V _{RMS}	35	70	140	280	420	Volts
Maximum DC Blocking Voltage	V _{DC}	50	100	200	400	600	Volts
Maximum Average Forward Rectified Current at T _T = 75°C	I _(AV)	0.5					Amps
Peak Forward Surge Current 8.3ms single half sine-wave superimposed on rated load (JEDEC Method)	I _{FSM}	10.0					Amps
Maximum Instantaneous Forward Voltage at 0.5A	V _F	1.1					Volts
Maximum DC Reverse Current T _A = 25°C at Rated DC Blocking Voltage T _A = 125°C	I _R	50.0					µA
Maximum Full Load Reverse Current, Full Cycle Average, at T _A = 75°C	I _{R(AV)}	20					µA
Typical Junction Capacitance (Note 1)	C _J	7.0					pf
Maximum Thermal Resistance R _{thJL} (Note 2) R _{thJA} (Note 3)	R _{θJL}	70.0					°C/W
	R _{θJA}	150.0					
Operating and Storage Temperature Range	T _J , T _{STG}	-65 to +175					°C
Polarity Color Bands (2 nd Band)		Gray	Red	Orange	Yellow	Green	

- NOTES: 1. Measured at 1 MHz and applied reverse voltage of 4.0 V_{DC}.
 2. Thermal resistance junction to terminal, 5.0mm² copper pads to each terminal.
 3. Thermal resistance junction to ambient, 5.0mm² copper pads to each terminal.

**RATINGS AND CHARACTERISTIC CURVES BYM05-50 THRU BYM05-600
GL34A THRU GL34J**

FIG. 1 — FORWARD CURRENT DERATING CURVE

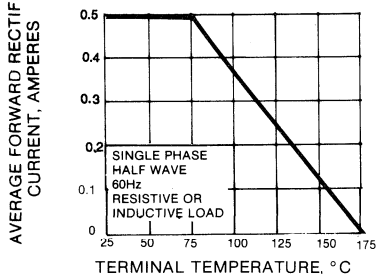

FIG. 2 — MAXIMUM NON-REPETITIVE PEAK FORWARD SURGE CURRENT

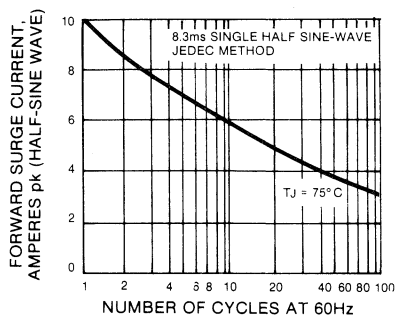

FIG. 3 — TYPICAL INSTANTANEOUS FORWARD CHARACTERISTICS

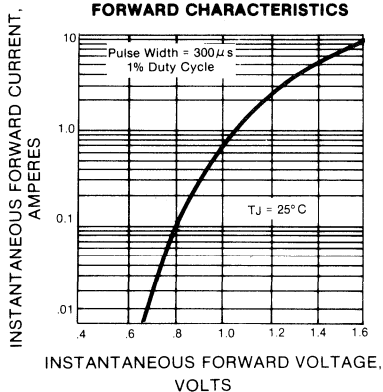

FIG. 4 — TYPICAL JUNCTION CAPACITANCE

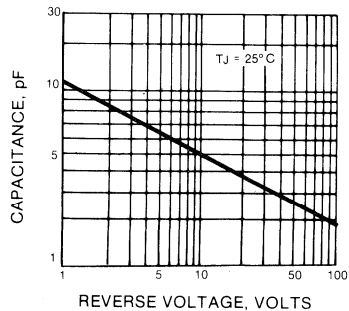
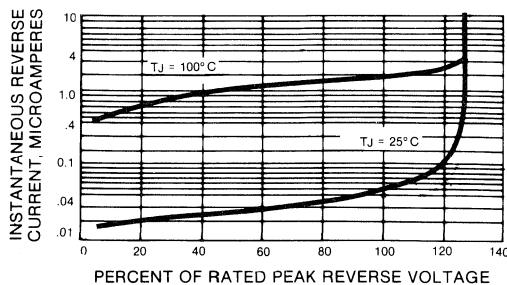

FIG. 5 — TYPICAL REVERSE CHARACTERISTICS



BYM06-50 THRU BYM06-600 RGL34A THRU RGL34J

SURFACE MOUNT GLASS PASSIVATED FAST SWITCHING SILICON RECTIFIER
Voltage - 50 to 600 Volts Current - 0.5 Amperes

FEATURES

- ◆ For surface mounted applications
- ◆ High temperature metallurgically bonded - no compression contacts as found in diode-constructed rectifiers
- ◆ Glass passivated junction
- ◆ Plastic package has Underwriters Laboratory Flammability Classification 94V-0
- ◆ Capable of meeting environmental standards of MIL-S-19500
- ◆ High temperature soldering guaranteed: 450°C/5 seconds at terminals. Complete device submersible temperature of 260°C for 10 seconds in solder bath

PATENTED*

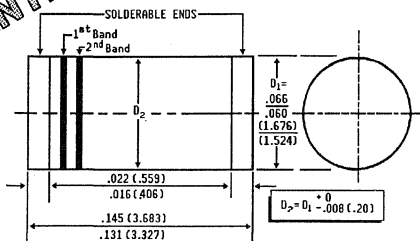

Dimensions in inches and (millimeters)

*Glass-plastic encapsulation technique is covered by Patent No. 3,996,602 of 1976; brazed-lead assembly to Patent No. 3,930,306 of 1976 and glass composition by Patent No. 3,752,701 of 1973.



MECHANICAL DATA

Case: Molded plastic over glass
Terminals: Plated terminals, solderable per MIL-STD-202, Method 208
Polarity: Two bands indicate cathode
 1st band denotes device type 2nd band denotes voltage type
Mounting Position: Any **Handling Precautions:** None
Weight: 0.036 gram, 0.0014 ounce

MAXIMUM RATINGS AND ELECTRICAL CHARACTERISTICS

Ratings at 25°C ambient temperature unless otherwise specified. 60 Hz, resistive or inductive load. For capacitive load, derate current by 20%.

	BYM06					UNITS	
	SYMBOLS	-50	-100	-200	-400		-600
Fast switching device: 1 st band is red		RGL34A	RGL34B	RGL34D	RGL34G	RGL34J	
Maximum Recurrent Peak Reverse Voltage	V _{RRM}	50	100	200	400	600	Volts
Maximum RMS Voltage	V _{RMS}	35	70	140	280	420	Volts
Maximum DC Blocking Voltage	V _{DC}	50	100	200	400	600	Volts
Maximum Average Forward Rectified Current at T _T = 55°C	I _(AV)	0.5					Amps
Peak Forward Surge Current 8.3ms single half sine-wave superimposed on rated load (JEDEC Method)	I _{FSM}	10.0					Amps
Maximum Instantaneous Forward Voltage at 0.5A	V _F	1.3					Volts
Maximum DC Reverse Current T _A = 25°C at Rated DC Blocking Voltage T _A = 125°C	I _R	5.0 50.0					μA
Maximum Full Load Reverse Current, Full Cycle Average, at T _A = 55°C	I _{R(AV)}	30.0					μA
Maximum Reverse Recovery Time (Note 1) T _A = 25°C	T _{RR}	150				250	ns
Typical Junction Capacitance (Note 2)	C _J	4.0					pf
Maximum Thermal Resistance (Note 3) (Note 4)	R _{θJL} R _{θJA}	70 150.0					°C/W
Operating and Storage Temperature Range	T _J , T _{STG}	-65 to +175					°C
Polarity Color Bands (2 nd Band)		Gray	Red	Orange	Yellow	Green	

NOTES: 1. Reverse Recovery Test Conditions I_F = 0.5A, I_R = 1.0A, I_{rr} = .25A. 2. Measured at 1 MHz and applied reverse voltage of 4.0 Volts.
 3. Thermal resistance from junction to terminal, 5mm² copper pads to each terminal
 4. Thermal resistance from junction to ambient, 5mm² copper pads to each terminal.

RATINGS AND CHARACTERISTIC CURVES BYM06-50 THRU BYM06-600 RGL34A THRU RGL34J

FIG. 1 — FORWARD CURRENT DERATING CURVE

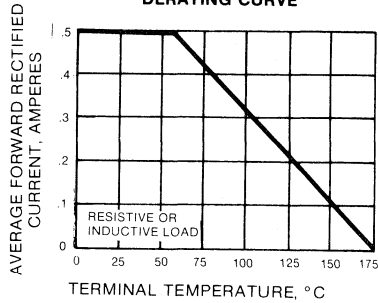

FIG. 2 — MAXIMUM NON-REPETITIVE PEAK FORWARD SURGE CURRENT

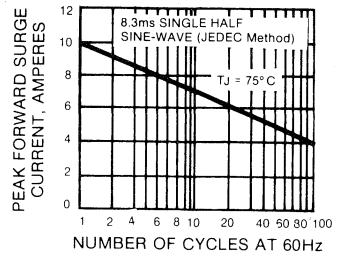

FIG. 4 — TYPICAL INSTANTANEOUS FORWARD CHARACTERISTICS

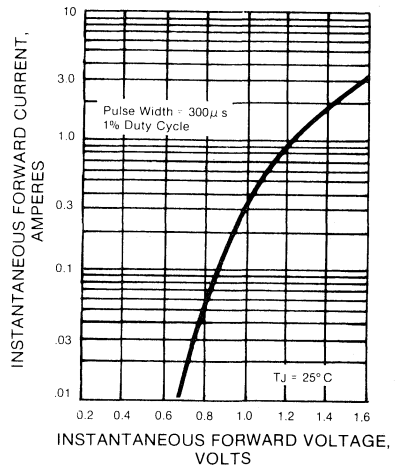

FIG. 3 — TYPICAL REVERSE CHARACTERISTICS

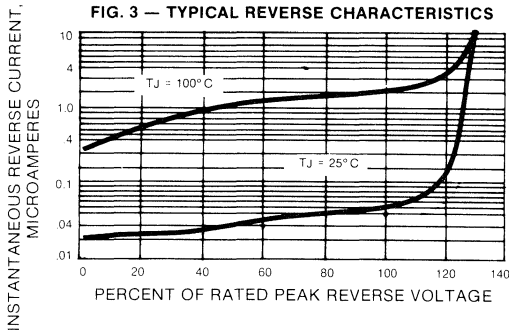

FIG. 5 — TYPICAL JUNCTION CAPACITANCE

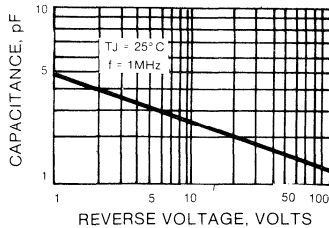
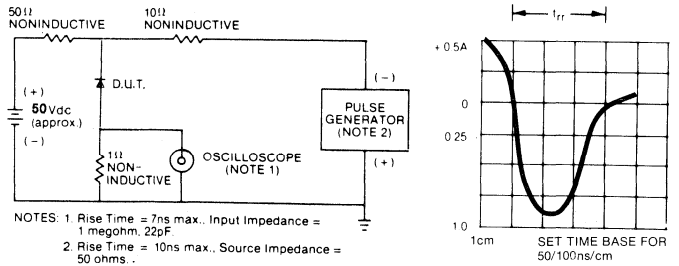

FIG. 6 — REVERSE RECOVERY TIME CHARACTERISTIC AND TEST CIRCUIT DIAGRAM



BYM07-50 THRU BYM07-400 EGL34A THRU EGL34G

SURFACE MOUNT GLASS PASSIVATED FAST EFFICIENT SILICON RECTIFIER
Voltage - 50 to 400 Volts Current - 0.5 Amperes

FEATURES

- ◆ For surface mounted applications
- ◆ High temperature metallurgically bonded - no compression contacts as found in diode-constructed rectifiers
- ◆ Glass passivated junction
- ◆ Plastic package has Underwriters Laboratory Flammability Classification 94V-0
- ◆ Fast switching for high efficiency
- ◆ High temperature soldering guaranteed: 450°C/5 seconds at terminals. Complete device submersible temperature of 260°C for 10 seconds in solder bath

PATENTED*

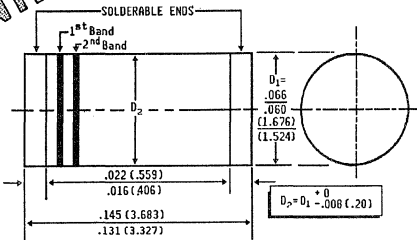

Dimensions in inches and (millimeters)

*Brazed-lead assembly is covered by Patent No. 3,930,306 of 1976 and glass composition by Patent No. 3,752,701 of 1973



MECHANICAL DATA

Case: Molded plastic over glass

Terminals: Plated terminals, solderable per MIL-STD-202, Method 208

Polarity: Two bands indicate cathode

1st band denotes device type 2nd band denotes voltage type

Mounting Position: Any **Handling Precautions:** None

Weight: 0.036 gram, 0.0014 ounce

MAXIMUM RATINGS AND ELECTRICAL CHARACTERISTICS

Ratings at 25°C ambient temperature unless otherwise specified. 60 Hz, resistive or inductive load. For capacitive load, derate current by 20%.

	BYM07							UNITS
	SYMBOLS	-50	-100	-150	-200	-300	-400	
Fast Efficient device: 1 st band is green		EGL34A	EGL34B	EGL34C	EGL34D	EGL34F	EGL34G	
Maximum Recurrent Peak Reverse Voltage	V _{RRM}	50	100	150	200	300	400	Volts
Maximum RMS Voltage	V _{RMS}	35	70	105	140	210	280	Volts
Maximum DC Blocking Voltage	V _{DC}	50	100	150	200	300	400	Volts
Maximum Average Forward Rectified Current at T _J = 75°C	I _(AV)	0.5						Amps
Peak Forward Surge Current, 8.3ms single half sine-wave superimposed on rated load (JEDEC Method)	I _{FSM}	10.0						Amps
Maximum Instantaneous Forward Voltage at 0.5A	V _F	1.25						Volts
Maximum DC Reverse Current T _A = 25°C at Rated DC Blocking Voltage T _A = 125°C	I _R	50.0						µA
Maximum Reverse Recovery Time (Note 1) T _J = 25°C	T _{RR}	50.0						nS
Typical Junction Capacitance (Note 2)	C _J	4.0						pf
Maximum Thermal Resistance (Note 3) (Note 4)	R _{θJL} R _{θJA}	70.0 150.0						°C/W
Operating and Storage Temperature Range	T _J , T _{STG}	-65 to +175						°C
Polarity Color Bands (2 nd Band)		Gray	Red	Pink	Orange	Brown	Yellow	

- NOTES:**
1. Reverse Recovery Test Conditions : I_F = 0.5A, I_R = 1.0A, I_{rr} = .25A
 2. Measured at 1 MHz and applied reverse voltage of 4.0 Volts.
 3. Thermal resistance from junction to terminal, 5.0mm² copper pads to each terminal.
 4. Thermal resistance from junction to ambient, 5.0mm² copper pads to each terminal.

**RATINGS AND CHARACTERISTIC CURVES BYM07-50 THRU BYM07-400
EGL34A THRU EGL34G**

FIG. 1 — FORWARD CURRENT DERATING CURVE

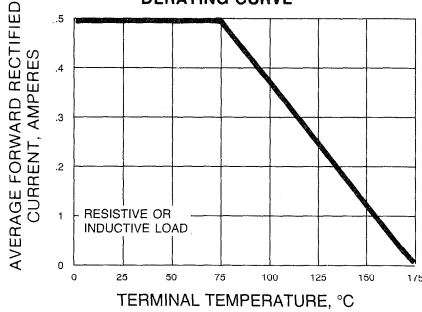

FIG. 2 — MAXIMUM NON-REPETITIVE PEAK FORWARD SURGE CURRENT

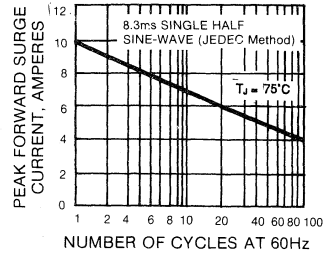

FIG. 3 — TYPICAL INSTANTANEOUS FORWARD CHARACTERISTICS

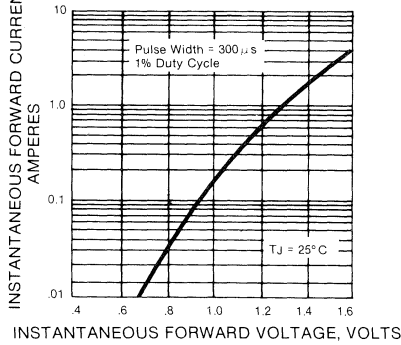

FIG. 4 — TYPICAL JUNCTION CAPACITANCE

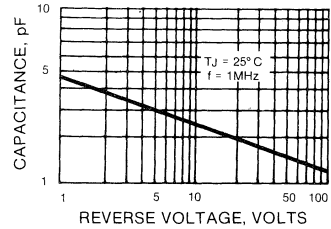
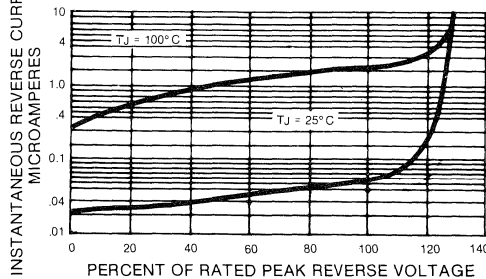

FIG. 5 — TYPICAL REVERSE CHARACTERISTICS



1N6478 THRU 1N6484

SURFACE MOUNT GLASS PASSIVATED SILICON RECTIFIER

Voltage - 50 to 1000 Volts Current - 1.0 Ampere

FEATURES

- ◆ For surface mounted applications
- ◆ High temperature metallurgically bonded - no compression contacts as found in diode-constructed rectifiers
- ◆ Glass passivated junction
- ◆ Plastic package has Underwriters Laboratory Flammability Classification 94V-0
- ◆ Capable of meeting environmental standards of MIL-S-19500
- ◆ High temperature soldering guaranteed 450°C/5 seconds at terminals. Complete device submersible temperature of 265°C for 10 seconds in solder bath

PATENTED*

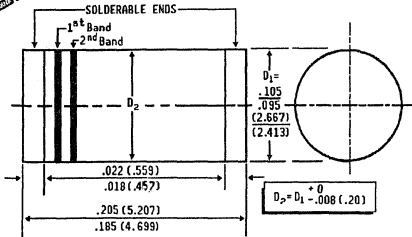

Dimensions in inches and (millimeters)

*Glass-plastic encapsulation technique is covered by Patent No. 3,996,602 of 1976; brazed-lead assembly to Patent No. 3,930,306 of 1976 and glass composition by Patent No. 3,752,701 of 1973.



MECHANICAL DATA

Case: Molded plastic over glass

Terminals: Plated terminals, solderable per MIL-STD-202, Method 208

Polarity: Two bands indicate cathode

1st band denotes device type 2nd band denotes voltage type

Mounting Position: Any **Handling Precautions:** None

Weight: 0.116 gram, 0.0046 ounce

MAXIMUM RATINGS AND ELECTRICAL CHARACTERISTICS

Ratings at 25°C ambient temperature unless otherwise specified. 60 Hz, resistive or inductive load. For capacitive load, derate current by 20%.

Standard recovery time device: 1 st band is white	SYMBOLS	1N 6478	1N 6479	1N 6480	1N 6481	1N 6482	1N 6483	1N 6484	UNITS
* Maximum Recurrent Peak Reverse Voltage	V _{RRM}	50	100	200	400	600	800	1000	Volts
Maximum RMS Voltage	V _{RMS}	35	70	140	280	420	560	700	Volts
* Maximum DC Blocking Voltage	V _{DC}	50	100	200	400	600	800	1000	Volts
* Maximum Average Forward Rectified Current at T _T = 75°C	I _(AV)	1.0							Amps
* Peak Forward Surge Current 8.3ms single half sine-wave superimposed on rated load (JEDEC Method) T _A = 75°C	I _{FSM}	30.0							Amps
* Maximum Instantaneous Forward Voltage at 1.0A T _A = 75°C T _A = 25°C	V _F	1.0 1.1							Volts
* Maximum DC Reverse Current at Rated DC Blocking Voltage T _A = 25°C T _A = 125°C	I _R	10.0 200							µA
* Maximum Full Load Reverse Current, Full Cycle Average, at T _A = 75°C	I _{R(AV)}	100							µA
Typical Junction Capacitance (Note 1)	C _J	15							pf
* Maximum Thermal Resistance (Note 2) (Note 3)	R _{θJL} R _{θJA}	20.0 50.0							*C/W
* Operating and Storage Temperature Range	T _J , T _{STG}	-65 to +175							*C
Polarity Color Bands (2 nd Band)		Gray	Red	Orange	Yellow	Green	Blue	Violet	

NOTES: 1. Measured at 1 MHz and applied reverse voltage of 4.0 Vdc.
2. Thermal resistance from junction to terminal, 6.0mm² copper pads to each terminal.
3. Thermal resistance from junction to ambient, 6.0mm² copper pads to each terminal.
* JEDEC Registered Values

RATINGS AND CHARACTERISTIC CURVES 1N6478 THRU 1N6484

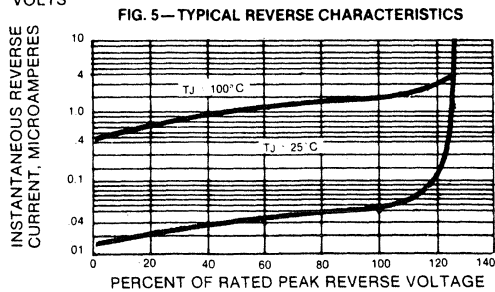
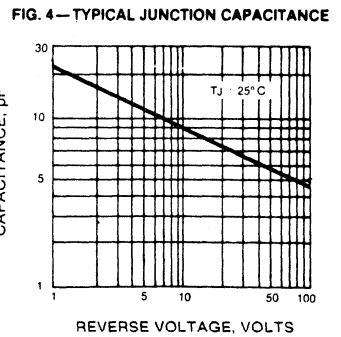
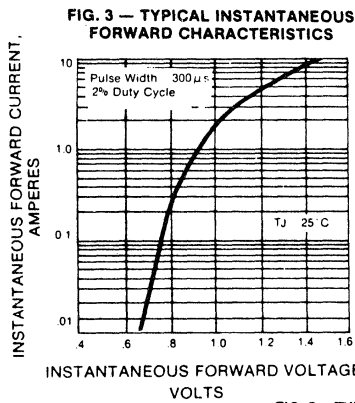
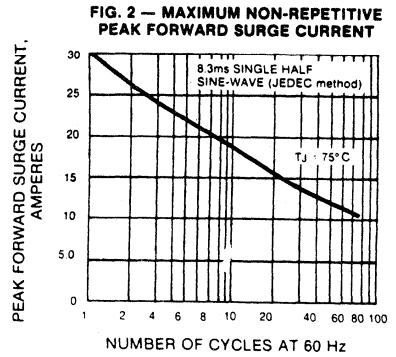
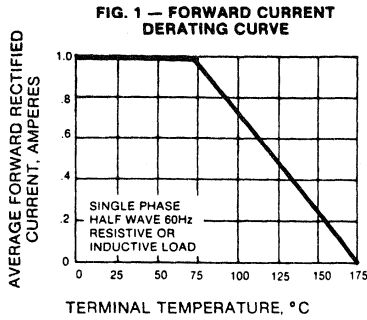

BYM10-50 THRU BYM10-1000 GL41A THRU GL41M

SURFACE MOUNT GLASS PASSIVATED SILICON RECTIFIER

Voltage - 50 to 1000 Volts Current - 1.0 Ampere

FEATURES

- ◆ For surface mounted applications
- ◆ High temperature metallurgically bonded - no compression contacts as found in diode-constructed rectifiers
- ◆ Glass passivated junction
- ◆ Plastic package has Underwriters Laboratory Flammability Classification 94V-0
- ◆ Capable of meeting environmental standards of MIL-S-19500
- ◆ High temperature soldering guaranteed: 450°C/5 seconds at terminals. Complete device submersible temperature of 265°C for 10 seconds in solder bath

PATENTED*

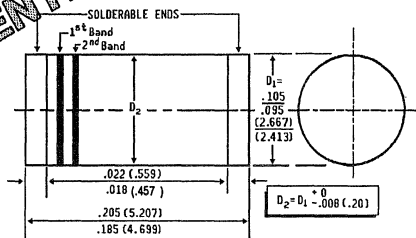

Dimensions in inches and (millimeters)

*Glass-plastic encapsulation technique is covered by Patent No. 3,996,602 of 1976; brazed-lead assembly to Patent No. 3,930,306 of 1976 and glass composition by Patent No. 3,752,701 of 1973.



MECHANICAL DATA

Case: Molded plastic over glass

Terminals: Plated Terminals, solderable per MIL-STD-202, Method B08

Polarity: Two bands indicate cathode

1st band denotes device type 2nd band denotes voltage type

Mounting Position: Any **Handling Precautions:** None

Weight: 0.116 gram, 0.0046 ounce

MAXIMUM RATINGS AND ELECTRICAL CHARACTERISTICS

Ratings at 25°C ambient temperature unless otherwise specified. 60 Hz, resistive or inductive load. For capacitive load, derate current by 20%.

	SYMBOLS	BYM10					BYM10A		UNITS
		-50	-100	-200	-400	-600	-800	-1000	
Standard recovery device: 1 st band is WHITE		GL41A	GL41B	GL41D	GL41G	GL41J	GL41K	GL41M	
Maximum Recurrent Peak Reverse Voltage	V _{RRM}	50	100	200	400	600	800	1000	Volts
Maximum RMS Voltage	V _{RMS}	35	70	140	280	420	560	700	Volts
Maximum DC Blocking Voltage	V _{DC}	50	100	200	400	600	800	1000	Volts
Maximum Average Forward Rectified Current T _T = 75°C	I _(AV)	1.0							Amps
Peak Forward Surge Current 8.3ms single half sine-wave superimposed on rated load (JEDEC Method)	I _{FSM}	30.0							Amps
Maximum Instantaneous Forward Voltage at 1.0A	V _F	1.1					1.2		Volts
Maximum DC Reverse Current T _A = 25°C at Rated DC Blocking Voltage T _A = 125°C	I _R	10.0					50.0		µA
Maximum Full Load Reverse Current, Full Cycle Average, at T _A = 75°C	I _{R(AV)}	30.0							µA
Typical Junction Capacitance (Note 1)	C _J	15.0							pf
Maximum Thermal Resistance (Note 2) (Note 3)	R _{θJL} R _{θJA}	30.0					75.0		°C/W
Operating and Storage Temperature Range	T _J , T _{STG}	-65 to +175							°C
Polarity Color Bands (2 nd Band)		Gray	Red	Orange	Yellow	Green	Blue	Violet	

NOTES: 1. Measured at 1 MHz and applied reverse voltage of 4.0 V_{DC}.

2. Thermal resistance from junction to terminal, 6.0mm² copper pads to each terminal.

3. Thermal resistance from junction to ambient, 6.0mm² copper pads to each terminal.

**RATINGS AND CHARACTERISTIC CURVES BYM10-50 THRU BYM10-1000
GL41A THRU GL41M**

FIG. 1 — FORWARD CURRENT DERATING CURVE

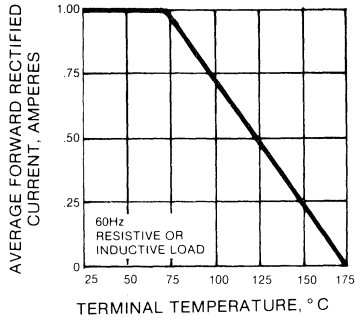

FIG. 2 — MAXIMUM NON-REPETITIVE PEAK FORWARD SURGE CURRENT

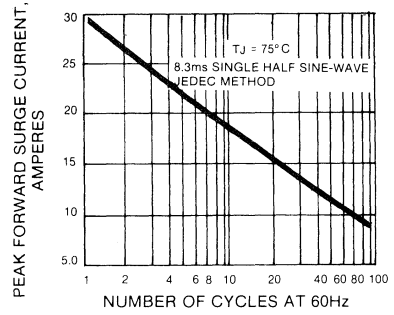

FIG. 3 — TYPICAL INSTANTANEOUS FORWARD CHARACTERISTICS

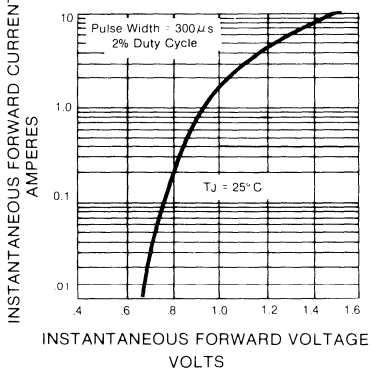

FIG. 4 — TYPICAL JUNCTION CAPACITANCE

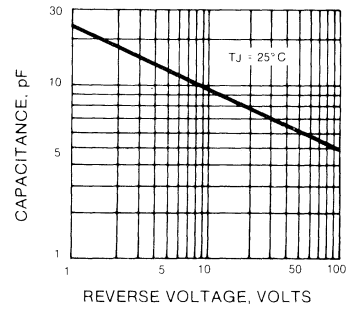
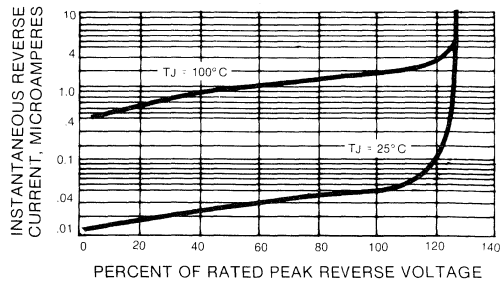

FIG. 5 — TYPICAL REVERSE CHARACTERISTICS



BYM11-50 THRU BYM11-1000 RGL41A THRU RGL41M

SURFACE MOUNT GLASS PASSIVATED FAST SWITCHING SILICON RECTIFIER

Voltage - 50 to 1000 Volts Current - 1.0 Ampere

FEATURES

- ◆ For surface mounted applications
- ◆ High temperature metallurgically bonded - no compression contacts as found in diode-constructed rectifiers
- ◆ Glass passivated junction
- ◆ Plastic package has Underwriters Laboratory Flammability Classification 94V-0
- ◆ Capable of meeting environmental standards of MIL-S-19500
- ◆ High temperature soldering guaranteed: 450°C/5 seconds at terminals. Complete device submersible temperature of 260°C for 10 seconds in solder bath

PATENTED*

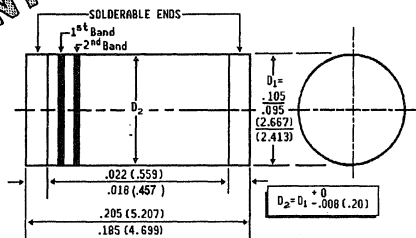

Dimensions in inches and (millimeters)

*Glass-plastic encapsulation technique is covered by Patent No. 3,996,602 of 1976; brazed-lead assembly to Patent No. 3,930,306 of 1976 and glass composition by Patent No. 3,752,701 of 1973.



MECHANICAL DATA

Case: Molded plastic over glass

Terminals: Plated Terminals, solderable per MIL-STD-202, Method 208

Polarity: Two bands indicate cathode

1st band denotes device type 2nd band denotes voltage type

Mounting Position: Any **Handling Precautions:** None

Weight: 0.116 gram, 0.0046 ounce

MAXIMUM RATINGS AND ELECTRICAL CHARACTERISTICS

Ratings at 25°C ambient temperature unless otherwise specified. 60 Hz, resistive or inductive load. For capacitive load, derate current by 20%.

	SYMBOLS	BYM11							UNITS
		- 50	-100	-200	-400	-600	-800	1000	
Fast switching time device: 1 st band is RED.		RGL 41A	RGL 41B	RGL 41D	RGL 41G	RGL 41J	RGL 41K	RGL 41M	
Maximum Recurrent Peak Reverse Voltage	V _{RRM}	50	100	200	400	600	800	1000	Volts
Maximum RMS Voltage	V _{RMS}	35	70	140	280	420	560	700	Volts
Maximum DC Blocking Voltage	V _{DC}	50	100	200	400	600	800	1000	Volts
Maximum Average Forward Rectified Current T _T = 55°C	I _(AV)	1.0							Amps
Peak Forward Surge Current 8.3ms single half sine-wave superimposed on rated load (JEDEC Method)	I _{FSM}	30.0							Amps
Maximum Instantaneous Forward Voltage at 1.0A	V _F	1.3							Volts
Maximum DC Reverse Current T _A = 25°C	I _R	5.0							μA
at Rated DC Blocking Voltage T _A = 125°C	I _R	50.0							μA
Maximum Full Load Reverse Current, Full Cycle Average, at T _A = 55°C	I _{R(AV)}	50.0							μA
Maximum Reverse Recovery Time (Note 1) T _J = 25°C	T _{RR}	150		250		500	500		ns
Typical Junction Capacitance (Note 4)	C _J	15.0							pf
Maximum Thermal Resistance (Note 2)	R _{θJL}	30.0							°C/W
(Note 3)	R _{θJA}	75.0							°C/W
Operating and Storage Temperature Range	T _J , T _{STG}	-65 to +175							°C
Polarity Color Bands (2 nd Band)		Gray	Red	Orange	Yellow	Green	Blue	Violet	

NOTES: 1. Reverse Recovery Test Conditions: I_F = 0.5A, I_R = 1.0A, I_{rr} = .25A.

2. Thermal resistance from junction to terminal, 6.0mm² copper pads to each terminal.

3. Thermal Resistance from junction to ambient 6.0mm² copper pads to each terminal

4. Measured at 1 MHz and applied reverse voltage of 4.0 Vdc.

RATINGS AND CHARACTERISTIC CURVES BYM11-50 THRU BYM11-1000 RGL41A THRU RGL41M

FIG. 1 — REVERSE RECOVERY TIME CHARACTERISTIC AND TEST CIRCUIT DIAGRAM

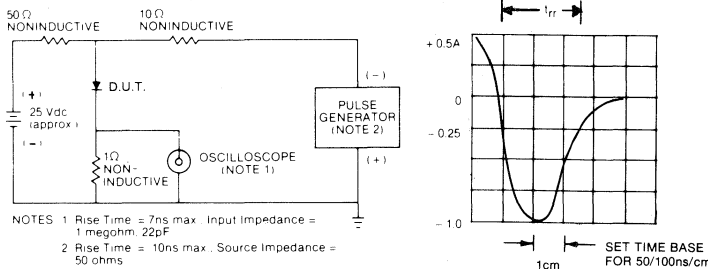

FIG. 2 — FORWARD CURRENT DERATING CURVE

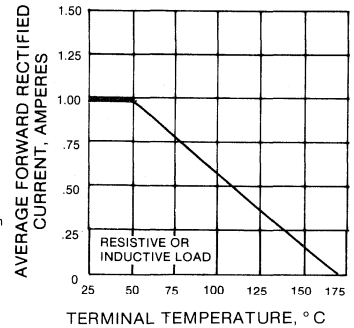

FIG. 3 — TYPICAL INSTANTANEOUS FORWARD CHARACTERISTICS

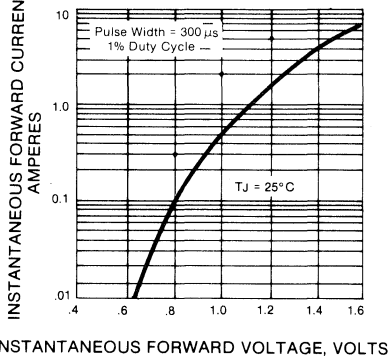

FIG. 4 — TYPICAL JUNCTION CAPACITANCE

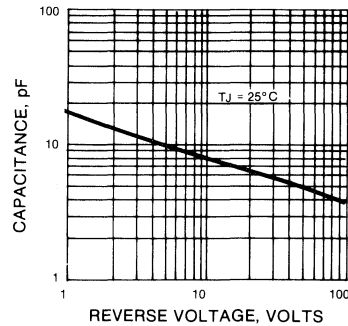

FIG. 5 — MAXIMUM NON-REPETITIVE PEAK FORWARD SURGE CURRENT

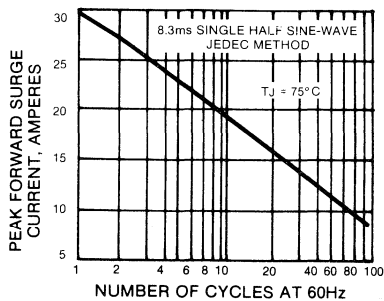
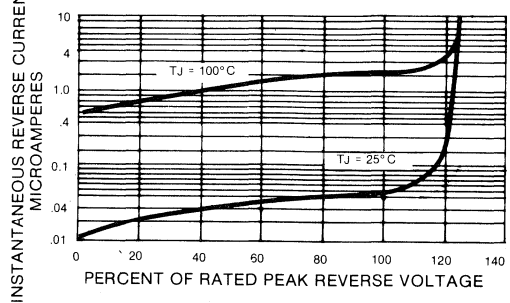

FIG. 5 — TYPICAL REVERSE CHARACTERISTICS



BYM12-50 THRU BYM12-400 EGL41A THRU EGL41G

SURFACE MOUNT GLASS PASSIVATED FAST EFFICIENT SILICON RECTIFIER
Voltage - 50 to 400 Volts Current - 1.0 Ampere

FEATURES

PATENTED*

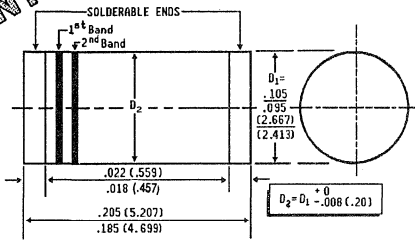

Dimensions in inches and (millimeters)

*Glass-plastic encapsulation technique is covered by Patent No. 3,996,602 of 1976; brazed-lead assembly to Patent No. 3,930,306 of 1976 and glass composition by Patent No. 3,752,701 of 1973.

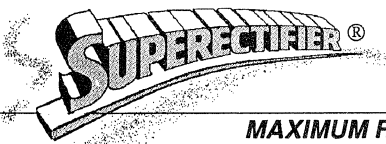

- ◆ For surface mounted applications
- ◆ High temperature metallurgically bonded - no compression contacts as found in diode-constructed rectifiers
- ◆ Glass passivated junction
- ◆ Plastic package has Underwriters Laboratory Flammability Classification 94V-0
- ◆ Superfast recovery times for high efficiency
- ◆ Capable of meeting environmental standards of MIL-S-19500
- ◆ High temperature soldering guaranteed: 450°C/5 seconds at terminals. Complete device submersible temperature of 265°C for 10 seconds in solder bath

MECHANICAL DATA

Case: Molded plastic over glass
Terminals: Solderable per MIL-STD-202, Method 208
Polarity: Two bands indicate cathode
 1st band denotes device type 2nd band denotes voltage type
Mounting Position: Any **Handling Precautions:** None
Weight: 0.116 gram, 0.0046 ounce

MAXIMUM RATINGS AND ELECTRICAL CHARACTERISTICS

Ratings at 25°C ambient temperature unless otherwise specified. 60 Hz, resistive or inductive load. For capacitive load, derate current by 20%.

	SYMBOLS	BYM12						UNITS
		-50	-100	-150	-200	300	-400	
Fast efficient devices: 1 st band is green		EGL 41A	EGL 41B	EGL 41C	EGL 41D	EGL 41F	EGL 41G	
Maximum Recurrent Peak Reverse Voltage	V _{RRM}	50	100	150	200	300	400	Volts
Maximum RMS Voltage	V _{RMS}	35	70	105	140	210	280	Volts
Maximum DC Blocking Voltage	V _{DC}	50	100	150	200	300	400	Volts
Maximum Average Forward Rectified Current at T _T = 75°C	I _(AV)	1.0						Amps
Peak Forward Surge Current, 8.3ms single half sine-wave superimposed on rated load (JEDEC Method)	I _{FSM}	30.0						Amps
Maximum Instantaneous Forward Voltage at 1.0A	V _F	1.0			1.25			Volts
Maximum DC Reverse Current T _A = 25°C at Rated DC Blocking Voltage T _A = 125°C	I _R	5.0			50.0			μA
Maximum Reverse Recovery Time (Note 1) T _J = 25°C	T _{RR}	50						ns
Typical Junction Capacitance (Note 2)	C _J	15.0						pf
Maximum Thermal Resistance R _{thJL} (Note 3) R _{thJA} (Note 4)	R _{θJL} R _{θJA}	30 60						°C/W
Operating and Storage Temperature Range	T _J , T _{STG}	-65 to +175						°C
Polarity Color Bands (2 nd Band)		Gray	Red	Pink	Orange	Brown	Yellow	

NOTES: 1. Reverse Recovery Test Conditions I_F = .5A, I_R = 1.0A, I_{rr} = .25A.
 3. Thermal resistance junction to terminal, 6.0mm² copper pads to each terminal.

2. Measured at 1 MHz and applied reverse voltage of 4.0 Volts.
 4. Thermal resistance junction to ambient, 6.0mm² copper pads to each terminal.

**RATINGS AND CHARACTERISTIC CURVES BYM12-50 THRU BYM12-400
EGL41A THRU EGL41G**

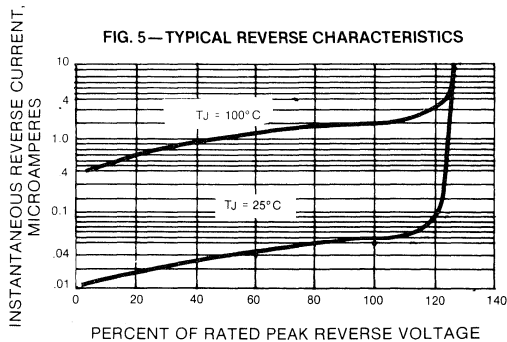
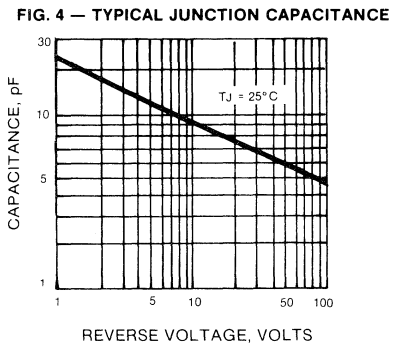
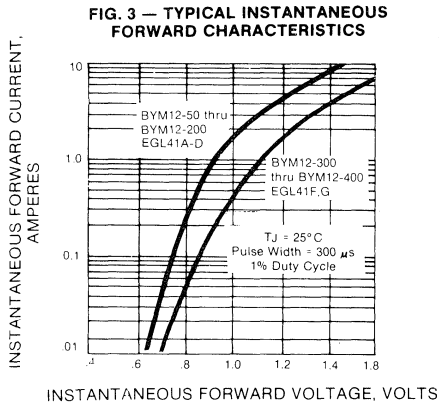
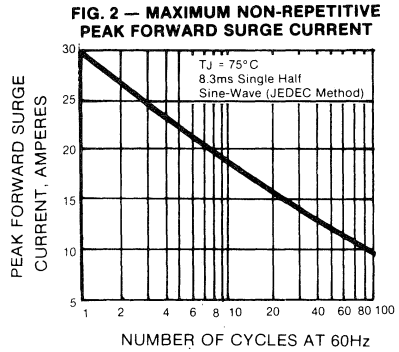
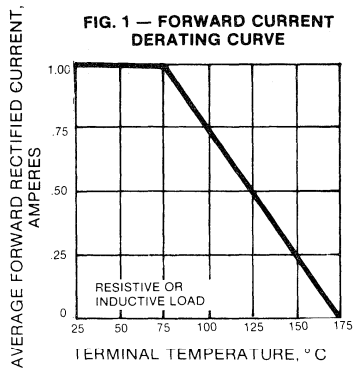

GLL4735 THRU GLL4763

1.0 WATT SURFACE MOUNT GLASS PASSIVATED ZENER

Voltage- 6.2-91.0 Volts Power Rating - 1.0 Watt

FEATURES

- ◆ For surface mounted applications
- ◆ Plastic package has Underwriter Laboratory Flammability Classification 94 V-0
- ◆ Glass passivated junction
- ◆ Low zener impedance
- ◆ Excellent clamping capability
- ◆ High temperature soldering guaranteed: 250°C/10 seconds/ at terminals

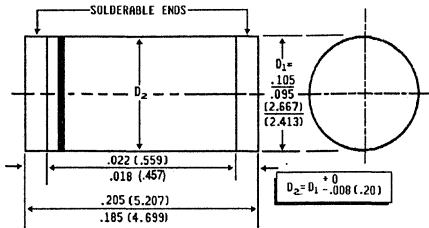

MECHANICAL DATA

Case: Molded plastic
Terminals: Solderable per MIL-STD-202, Method 208
Polarity: Red band denotes cathode
Mounting Position: Any
Handling Precautions: None
Weight: 0.116 grams, 0.0046 ounce

The plastic material covering the glass passivated junction

OPERATING AND STORAGE TEMPERATURE RANGE -65°C to +175°C

Type	*Nominal Zener Voltage @I _{ZT} V _Z Volts	Maximum DC Power Dissipation @T _T = 75°C PD Watts	Test Current I _{ZT} mA	Maximum Dynamic Impedance			Maximum Reverse Leakage Current @T _A = 25°C		Maximum Surge Current @T _A = 25°C (Note 1) I _R mApk	Maximum Forward Voltage @200mA @T _A = 25°C Volts
				ZZT OHMs	ZZK@ OHMs	IZK MA	I _R μA	V _R Volts		
GLL4735	6.2	1.0	41.0	2.0	700	1.0	10.0	3.0	730.0	1.2
GLL4736	6.8	1.0	37.0	3.5	700	1.0	10.0	4.0	660.0	1.2
GLL4737	7.5	1.0	34.0	4.0	700	0.5	10.0	5.0	605.0	1.2
GLL4738	8.2	1.0	31.0	4.5	700	0.5	10.0	6.0	550.0	1.2
GLL4739	9.1	1.0	28.0	5.0	700	0.5	10.0	7.0	500.0	1.2
GLL4740	10	1.0	25.0	7.0	700	0.25	10.0	7.6	454.0	1.2
GLL4741	11	1.0	23.0	8.0	700	0.25	5.0	8.4	414.0	1.2
GLL4742	12	1.0	21.0	9.0	700	0.25	5.0	9.1	380.0	1.2
GLL4743	13	1.0	19.0	10.0	700	0.25	5.0	9.9	344.0	1.2
GLL4744	15	1.0	17.0	14.0	700	0.25	5.0	11.4	305.0	1.2
GLL4745	16	1.0	15.5	16.0	700	0.25	5.0	12.2	285.0	1.2
GLL4746	18	1.0	14.0	20.0	750	0.25	5.0	13.7	250.0	1.2
GLL4747	20	1.0	12.5	22.0	750	0.25	5.0	15.2	225.0	1.2
GLL4748	22	1.0	11.5	23.0	750	0.25	5.0	16.7	205.0	1.2
GLL4749	24	1.0	10.5	25.0	750	0.25	5.0	18.2	190.0	1.2
GLL4750	27	1.0	9.5	35.0	750	0.25	5.0	20.6	170.0	1.2
GLL4751	30	1.0	8.5	40.0	1000	0.25	5.0	22.8	150.0	1.2
GLL4752	33	1.0	7.5	45.0	1000	0.25	5.0	25.1	135.0	1.2
GLL4753	36	1.0	7.0	50.0	1000	0.25	5.0	27.4	125.0	1.2
GLL4754	39	1.0	6.5	60.0	1000	0.25	5.0	29.7	115.0	1.2
GLL4755	43	1.0	6.0	70.0	1500	0.25	5.0	32.7	110.0	1.2
GLL4756	47	1.0	5.5	80.0	1500	0.25	5.0	35.8	95.0	1.2
GLL4757	51	1.0	5.0	95.0	1500	0.25	5.0	38.8	90.0	1.2
GLL4758	56	1.0	4.5	110.0	2000	0.25	5.0	42.6	80.0	1.2
GLL4759	62	1.0	4.0	125.0	2000	0.25	5.0	47.1	70.0	1.2
GLL4760	68	1.0	3.7	150.0	2000	0.25	5.0	51.7	65.0	1.2
GLL4761	75	1.0	3.3	175.0	2000	0.25	5.0	56.0	60.0	1.2
GLL4762	82	1.0	3.0	200.0	3000	0.25	5.0	62.2	55.0	1.2
GLL4763	91	1.0	2.0	250.0	3000	0.25	5.0	69.2	50.0	1.2

*Standard Voltage Tolerance ±10%, Suffix A 5% Note 1 : Surge Current is non-repetitive, 8.3 ms pulse width square wave or equivalent sine-wave superimposed on I_{ZT} per JEDEC method.

RATINGS AND CHARACTERISTIC CURVES GLL4735 THRU GLL4763

FIG. 1 — MAXIMUM CONTINUOUS POWER DISSIPATION

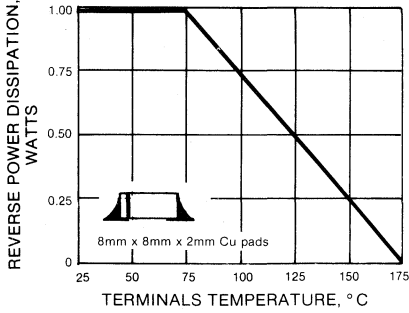

FIG. 3 — TYPICAL INSTANTANEOUS FORWARD CHARACTERISTICS

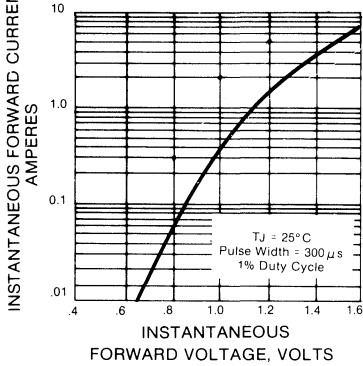

FIGURE 2 — TYPICAL ZENER IMPEDANCE

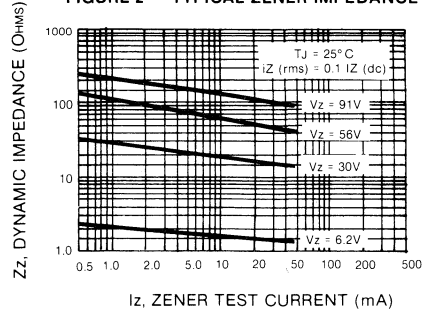

FIG. 4 — TYPICAL REVERSE CHARACTERISTICS

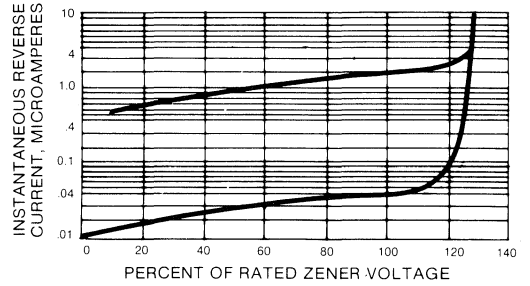
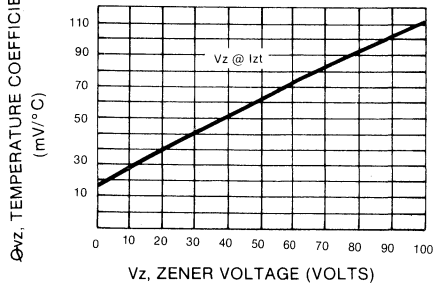

FIG. 5 — TYPICAL TEMPERATURE COEFFICIENTS



ZGL41-100 THRU ZGL41-200

1.0 WATT SURFACE MOUNT GLASS PASSIVATED ZENER

Voltage- 100 - 200 Volts Power Rating - 1.0 Watt

FEATURES

- ◆ For surface mounted applications
- ◆ Plastic package has Underwriters Laboratory Flammability Classification 94 V-O
- ◆ Glass passivated junction
- ◆ Low zener impedance
- ◆ Excellent clamping capability
- ◆ High temperature soldering guaranteed: 250°C/10 seconds/ at terminals

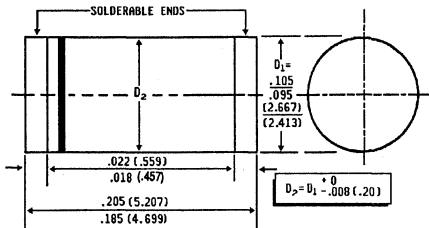

Dimensions in inches
and
(millimeters)

MECHANICAL DATA

Case: Molded plastic

Terminals: Solderable per MIL-STD-202, Method 208

Polarity: Red band denotes cathode

Mounting Position: Any

Handling Precautions: None

Weight: 0.116 grams, 0.0046 ounce

MAXIMUM RATINGS AND ELECTRICAL CHARACTERISTICS

Ratings at 25°C ambient temperature unless otherwise specified.

The plastic material covering the glass passivated junction carries U/L recognition 94V-O
OPERATING AND STORAGE TEMPERATURE RANGE -65°C to +175°C

TYPE	NOMINAL ZENER VOLTAGE @ I_{ZT}	MAXIMUM DC POWER DISSIPATION @ $T_r=75$ PD	TEST CURRENT I_{ZT}	MAXIMUM DYNAMIC IMPEDANCE			MAXIMUM REVERSE LEAKAGE CURRENT @ $T_A=25$ C		MAXIMUM SURGE CURRENT @ $T_A=25$ C (NOTE 1)	MAXIMUM FORWARD VOLTAGE @ 200mA @ $T_A=25$ C
	VOLTS	WATTS	mA	ZZT OHMS	ZZK OHMS @	IZK I_r mA	I_r μ A	I_{ZM} VOLTS	V_F mAdc	VOLTS
ZGL41-100	100	1.0	3.7	250	3100	0.25	1.0	76.0	10.0	1.5
ZGL41-110	110	1.0	3.4	300	4000	0.25	1.0	83.6	9.1	1.5
ZGL41-120	120	1.0	3.1	380	4500	0.25	1.0	91.2	8.3	1.5
ZGL41-130	130	1.0	2.9	450	5000	0.25	1.0	98.8	7.7	1.5
ZGL41-140	140	1.0	2.7	525	5500	0.25	1.0	106.4	7.1	1.5
ZGL41-150	150	1.0	2.5	600	6000	0.25	1.0	114	6.7	1.5
ZGL41-160	160	1.0	2.3	700	6500	0.25	1.0	121.6	6.3	1.5
ZGL41-170	170	1.0	2.2	800	6750	0.25	1.0	129.2	5.9	1.5
ZGL41-180	180	1.0	2.1	900	7000	0.25	1.0	136.98	5.6	1.5
ZGL41-190	190	1.0	2.0	1050	7500	0.25	1.0	144.4	5.3	1.5
ZGL41-200	200	1.0	1.9	1200	8000	0.25	1.0	152	5.0	1.5

* Standard Voltage Tolerance \pm 10%, Suffix A \pm 5%.

RATINGS AND CHARACTERISTIC CURVES ZGL41-100 THRU ZGL41-200

FIG. 1 — MAXIMUM CONTINUOUS POWER DISSIPATION

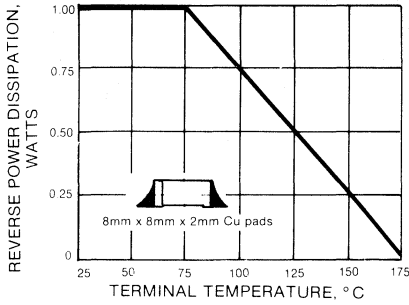

FIG. 2 — TYPICAL ZENER IMPEDANCE

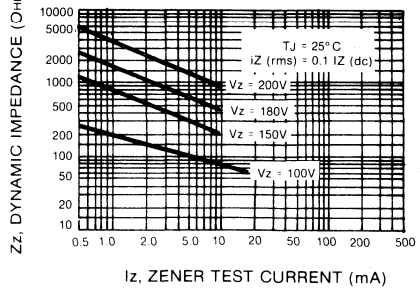

FIG. 3 — TYPICAL INSTANTANEOUS FORWARD CHARACTERISTICS

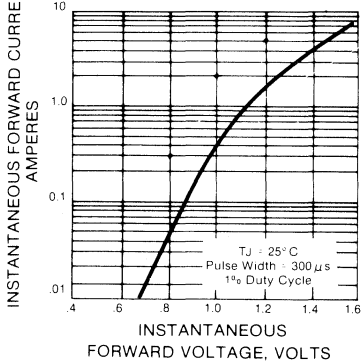

FIG. 4 — TYPICAL REVERSE CHARACTERISTICS

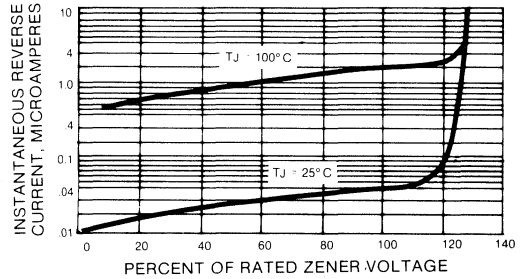
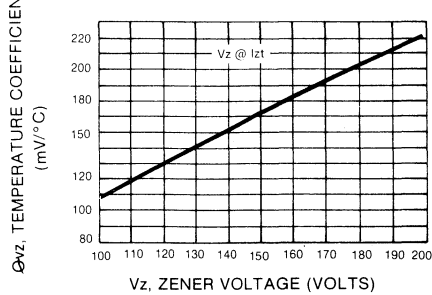

FIG. 5 — TYPICAL TEMPERATURE COEFFICIENTS



BYM13-20 THRU BYM13-60 SGL41-20 THRU SGL41-60

SURFACE MOUNT SCHOTTKY RECTIFIER
Voltage - 20 to 60 Volts Current - 1.0 Amperes

FEATURES

- ◆ For surface mounted applications
- ◆ Plastic material used carries Underwriters Laboratory Flammability Classifications 94V-0
- ◆ Metal to silicon rectifier, majority carrier conduction
- ◆ Low power loss, high efficiency
- ◆ High current capability, low V_F
- ◆ For use in low voltage, high frequency inverters, free wheeling and polarity protection applications
- ◆ High temperature soldering guaranteed: 250°C/10 seconds at terminals

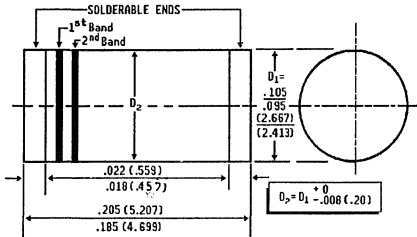

Dimensions in inches
and
(millimeters)

MECHANICAL DATA

Case: Molded plastic

Terminals: Solderable per

MIL-STD-202, Method 208

Polarity: Two bands indicate cathode

1st band denotes device type 2nd band denotes voltage type

Mounting Position: Any

Handling Precautions: None

Weight: 0.116 gram, 0.0046 ounce

MAXIMUM RATINGS AND ELECTRICAL CHARACTERISTICS

Ratings at 25°C ambient temperature unless otherwise specified. Single phase, half wave, 60 Hz, resistive or inductive load. For capacitive load, derate current by 20%.

	SYMBOLS	BYM13					UNITS
		-20	-30	-40	-50	-60	
Schottky devices: 1st band is orange		SGL41-20	SGL41-30	SGL41-40	SGL41-50	SGL41-60	
Maximum Recurrent Peak Reverse Voltage	V_{RRM}	20	30	40	50	60	Volts
Maximum RMS Voltage	V_{RMS}	14	21	28	35	42	Volts
Maximum DC Blocking Voltage	V_{DC}	20	30	40	50	60	Volts
Maximum Average Forward Rectified Current at $T_T = 75^\circ\text{C}$	$I_{(AV)}$	1.0					Amps
Peak Forward Surge Current 8.3ms single half sine-wave superimposed on rated load (JEDEC Method)	I_{FSM}	30.0					Amps
Maximum Instantaneous Forward Voltage at 1.0A	V_F	.50		.70			Volts
Maximum Reverse Current $T_J = 25^\circ\text{C}$ at Rated DC Blocking Voltage $T_J = 100^\circ\text{C}$	I_R	0.5			10		mA
Typical Junction Capacitance (Note 1)	C_J	110			80		pf
Maximum Thermal Resistance R_{thJL} (Note 2) R_{thJA} (Note 3)	$R_{\theta JL}$ $R_{\theta JA}$	30			75		$^\circ\text{C/W}$
Operating Temperature Range	T_J	-65 to +125					$^\circ\text{C}$
Storage Temperature Range	T_{STG}	-65 to +175					$^\circ\text{C}$
Polarity Color Bands (2 nd Band)		Gray	Red	Orange	Yellow	Green	

NOTES:

1. Measured at 1 MHz and applied reverse voltage of 4.0 V_{DC} .
2. Thermal resistance junction to terminal, 6.0mm² copper pads to each terminal.
3. Thermal resistance junction to ambient, 6.0mm² copper pads to each terminal.

**RATINGS AND CHARACTERISTIC CURVES BYM13-20 THRU BYM13-60
SGL41-20 THRU SGL41-60**

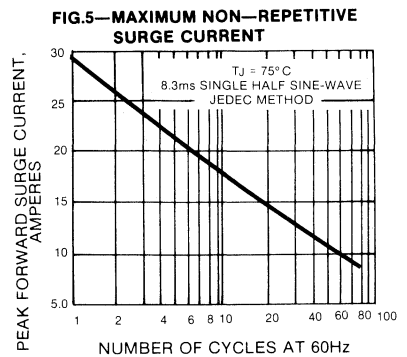
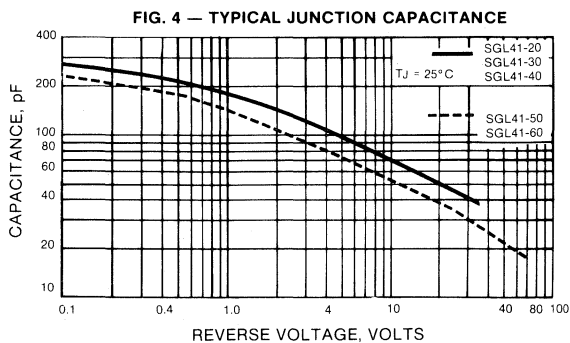
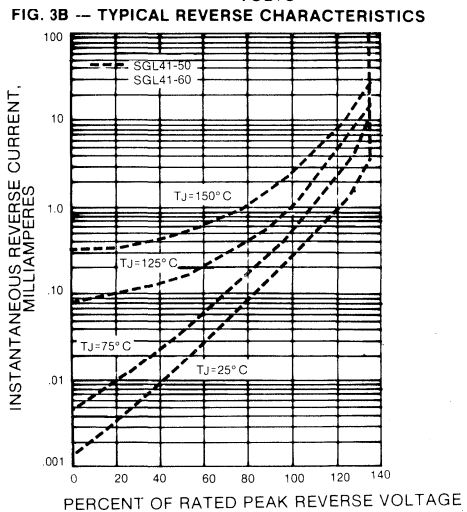
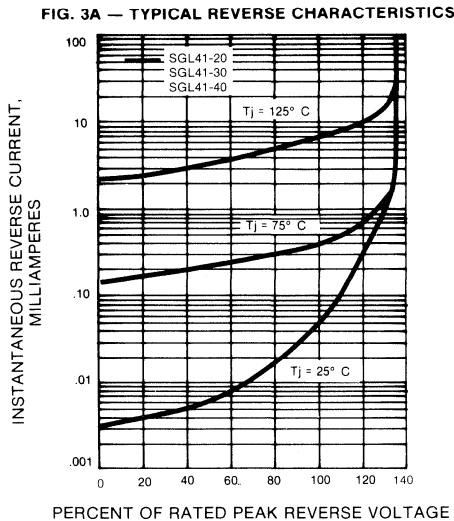
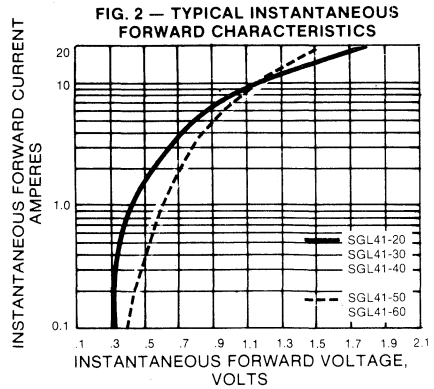
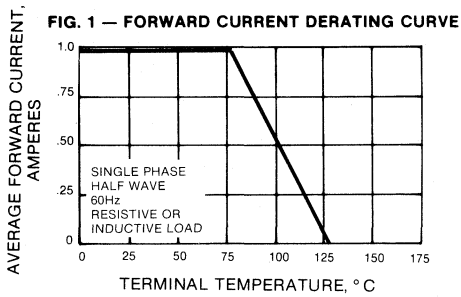

TGL41 SERIES

SURFACE MOUNT TRANSIENT VOLTAGE SUPPRESSOR

Voltage - 6.8 to 200 Volts

FEATURES

- ◆ For surface mounted applications
- ◆ Plastic material used carries Underwriters Laboratory Flammability Classifications 94V-0
- ◆ Glass passivated junction
- ◆ Excellent clamping capability
- ◆ Fast response time: typically less than 1.0ps from 0 volts to BV min.
- ◆ Typical I_R less than $1 \mu A$ above 10V
- ◆ High temperature soldering guaranteed: 250°C/10 seconds at terminals

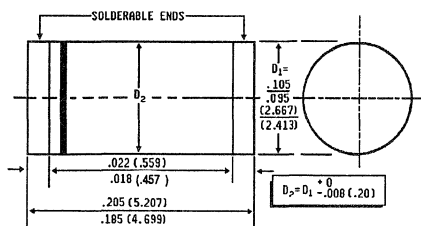

*Dimensions in inches
and
millimeters*

MECHANICAL DATA

Case: Molded plastic

Terminals: Solderable per MIL-STD-202, Method 208

Polarity: Blue band denotes cathode

Mounting Position: Any

Handling Precautions: None

Weight: 0.116 gram, 0.0046 ounce

MAXIMUM RATINGS AND ELECTRICAL CHARACTERISTICS

Ratings at 25°C ambient temperature unless otherwise specified.

RATINGS	SYMBOL	VALUE	UNITS
Peak Power Dissipation at $T_A = 25^\circ C$, $T_p = 1ms$ (Note 1)	Ppk	Minimum 400	Watts
Steady State Power Dissipation at $T_T = 75^\circ C$ (Note 2)	P_D	1.0	Watt
Peak Forward Surge Current, 8.3ms single half Sine-Wave Superimposed on Rated Load (JEDEC Method) (Note 3)	I_{FSM}	40.0	Amps
Operating and Storage Temperature Range	T_J, T_{STG}	-65 to +175	$^\circ C$

NOTES:

1. Non-repetitive current pulse, per Fig. 3 and derated above $T_A = 25^\circ C$ per Fig. 2.
2. Mounted on 8.0 mm^2 copper pads to each terminal.
3. 8.3ms single half sine-wave duty cycle = 4 pulses per minutes maximum.

ELECTRICAL CHARACTERISTICS (T_A = 25 °C UNLESS OTHERWISE NOTED)

DEVICE	Breakdown Voltage			Working Peak Reverse Voltage V _{RWM} (Volts)	Maximum Reverse Leakage at V _{RWM} I _R (μA)	Maximum Reverse Current I _{RSM} (Note 2) (Amps)	Maximum Reverse Voltage at I _{RSM} (Clamping Voltage) V _{RSM} (Volts)	Maximum Temperature Coefficient of V _{BR} (% / °C)
	V _{BR} @ I _T							
	MIN	MAX						
TGL41-6.8	6.12	7.48	10	5.50	1000	37	10.8	0.060
TGL41-6.8A	6.45	7.14	10	5.80	1000	38	10.5	0.060
TGL41-7.5	6.75	8.25	10	6.05	500	34	11.7	0.064
TGL41-7.5A	7.13	7.88	10	6.40	500	35	11.3	0.064
TGL41-8.2	7.38	9.02	10	6.63	200	32	12.5	0.068
TGL41-8.2A	7.79	8.61	10	7.02	200	33	12.1	0.068
TGL41-9.1	8.19	10.0	1.0	7.37	50	29	13.8	0.071
TGL41-9.1A	8.65	9.55	1.0	7.78	50	30	13.4	0.071
TGL41-10	9.00	11.0	1.0	8.10	10	27	15.0	0.076
TGL41-10A	9.50	10.5	1.0	8.55	10	28	14.5	0.076
TGL41-11	9.90	12.1	1.0	8.92	5.0	25	16.2	0.078
TGL41-11A	10.5	11.6	1.0	9.40	5.0	26	15.6	0.078
TGL41-12	10.8	13.2	1.0	9.72	5.0	23	17.3	0.081
TGL41-12A	11.4	12.6	1.0	10.2	5.0	24	16.7	0.081
TGL41-13	11.7	14.3	1.0	10.5	5.0	21	19.0	0.084
TGL41-13A	12.4	13.7	1.0	11.1	5.0	22	18.2	0.084
TGL41-15	13.5	16.5	1.0	12.1	5.0	18.20	22.0	0.087
TGL41-15A	14.3	15.8	1.0	12.8	5.0	18.90	21.2	0.087
TGL41-16	14.4	17.6	1.0	12.9	5.0	17.00	23.5	0.089
TGL41-16A	15.2	16.8	1.0	13.6	5.0	17.80	22.5	0.089
TGL41-18	16.2	19.8	1.0	14.5	5.0	15.10	26.5	0.091
TGL41-18A	17.1	18.9	1.0	15.3	5.0	15.90	25.2	0.091
TGL41-20	18.0	22.0	1.0	16.2	5.0	13.70	29.1	0.093
TGL41-20A	19.0	21.0	1.0	17.1	5.0	14.40	27.7	0.093
TGL41-22	19.8	24.2	1.0	17.8	5.0	12.50	31.9	0.095
TGL41-22A	20.9	23.1	1.0	18.8	5.0	13.10	30.6	0.095
TGL41-24	21.6	26.4	1.0	19.4	5.0	11.50	34.7	0.097
TGL41-24A	22.8	25.2	1.0	20.5	5.0	12.00	33.2	0.097
TGL41-27	24.3	29.7	1.0	21.8	5.0	10.20	39.1	0.099
TGL41-27A	25.7	28.4	1.0	23.1	5.0	10.70	37.5	0.099
TGL41-30	27.0	33.0	1.0	24.3	5.0	9.20	43.5	0.100
TGL41-30A	28.5	31.5	1.0	25.6	5.0	9.70	41.4	0.100
TGL41-33	29.7	36.3	1.0	26.8	5.0	8.40	47.7	0.101
TGL41-33A	31.4	34.7	1.0	28.2	5.0	8.80	45.7	0.101
TGL41-36	32.4	39.6	1.0	29.1	5.0	7.70	52.0	0.102
TGL41-36A	34.2	37.8	1.0	30.8	5.0	8.00	49.9	0.102
TGL41-39	35.1	42.9	1.0	31.6	5.0	7.10	56.4	0.103
TGL41-39A	37.1	41.0	1.0	33.3	5.0	7.40	53.9	0.103
TGL41-43	38.7	47.3	1.0	34.8	5.0	6.50	61.9	0.104
TGL41-43A	40.9	45.2	1.0	36.8	5.0	6.70	59.3	0.104

ELECTRICAL CHARACTERISTICS ($T_A = 25^\circ\text{C}$ unless otherwise noted)

DEVICE	Breakdown Voltage			Working Peak Reverse Voltage VRWM (Volts)	Maximum Reverse Leakage at VRWM IR (μA)	Maximum Reverse Current IRSM (Note 2) (Amps)	Maximum Reverse Voltage at IRSM (Clamping Voltage) VRSM (Volts)	Maximum Temperature Coefficient of VBR (% / $^\circ\text{C}$)
	VBR Volts (Note 1)		@IT (mA)					
	MIN.	MAX.						
TGL41-47	42.3	51.7	1.0	38.1	5.0	5.90	67.8	0.104
TGL41-47A	44.7	49.4	1.0	40.2	5.0	6.20	64.8	0.104
TGL41-51	45.9	56.1	1.0	41.3	5.0	5.40	73.5	0.105
TGL41-51A	48.5	53.6	1.0	43.6	5.0	5.70	70.1	0.105
TGL41-56	50.4	61.6	1.0	45.4	5.0	5.00	80.5	0.106
TGL41-56A	53.2	58.8	1.0	47.8	5.0	5.20	77.0	0.106
TGL41-62	55.8	68.2	1.0	50.2	5.0	4.50	89.0	0.107
TGL41-62A	58.9	65.1	1.0	53.0	5.0	4.70	85.0	0.107
TGL41-68	61.2	74.8	1.0	55.1	5.0	4.10	98.0	0.107
TGL41-68A	64.6	71.4	1.0	58.1	5.0	4.30	92.0	0.107
TGL41-75	67.5	82.5	1.0	60.7	5.0	3.70	108.0	0.108
TGL41-75A	71.3	78.8	1.0	64.1	5.0	3.90	103.0	0.108
TGL41-82	73.8	90.2	1.0	66.4	5.0	3.40	118.0	0.108
TGL41-82A	77.9	86.1	1.0	70.1	5.0	3.50	113.0	0.108
TGL41-91	81.9	100.0	1.0	73.7	5.0	3.00	131.8	0.109
TGL41-91A	86.5	95.50	1.0	77.8	5.0	3.20	125.0	0.109
TGL41-100	90.0	110.0	1.0	81.0	5.0	1.39	144.0	0.109
TGL41-100A	95.0	105.0	1.0	85.5	5.0	1.46	137.0	0.109
TGL41-110	99.0	121.0	1.0	89.2	5.0	1.27	158.0	0.110
TGL41-110A	105.0	116.0	1.0	94.0	5.0	1.32	152.0	0.110
TGL41-120	108.0	132.0	1.0	97.2	5.0	1.16	173.0	0.110
TGL41-120A	114.0	126.0	1.0	102.0	5.0	1.21	165.0	0.110
TGL41-130	117.0	143.0	1.0	105.0	5.0	1.07	187.0	0.110
TGL41-130A	124.0	137.0	1.0	111.0	5.0	1.12	179.0	0.110
TGL41-150	135.0	165.0	1.0	121.0	5.0	.93	215.0	0.111
TGL41-150A	143.0	158.0	1.0	128.0	5.0	.97	207.0	0.111
TGL41-160	144.0	176.0	1.0	130.0	5.0	.87	230.0	0.111
TGL41-160A	152.0	168.0	1.0	136.0	5.0	.91	219.0	0.111
TGL41-170	153.0	187.0	1.0	138.0	5.0	.82	244.0	0.111
TGL41-170A	162.0	179.0	1.0	145.0	5.0	.85	234.0	0.111
TGL41-180	162.0	198.0	1.0	146.0	5.0	.78	258.0	0.111
TGL41-180A	171.0	189.0	1.0	154.0	5.0	.81	246.0	0.111
TGL41-200	180.0	220.0	1.0	162.0	5.0	.70	287.0	0.111
TGL41-200A	190.0	210.0	1.0	171.0	5.0	.73	274.0	0.111

NOTES:

1. VBR measured after IT applies for 300 μs IT = Square Wave Pulse or equivalent.
2. Surge Current Waveform per Figure 3 and Derate per Figure 2.

RATINGS AND CHARACTERISTIC CURVES TGL41 SERIES

FIGURE 1 — PULSE RATING CURVE

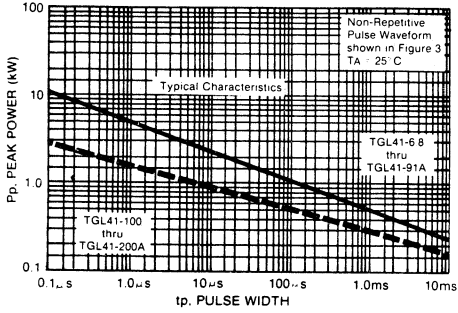

FIGURE 2 — PULSE DERATING CURVE

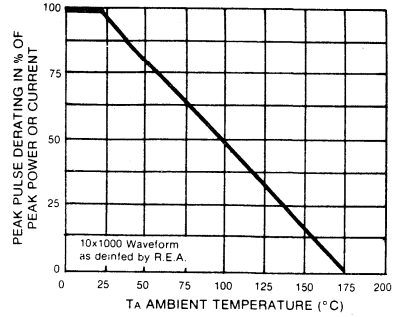

FIGURE 3 — PULSE WAVEFORM

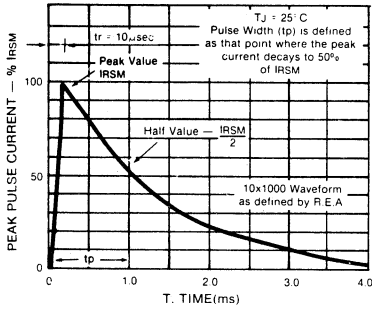

FIGURE 4 — TYPICAL JUNCTION CAPACITANCE

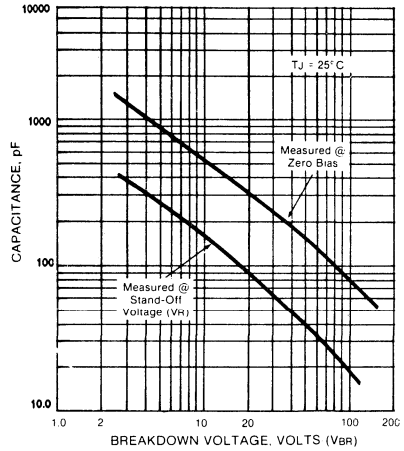

FIGURE 5 — STEADY STATE POWER DERATING

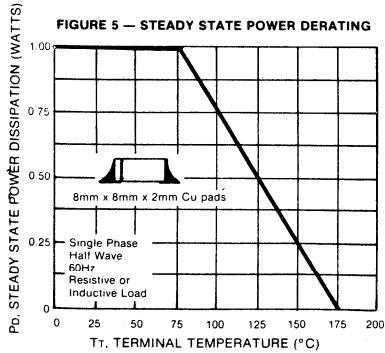
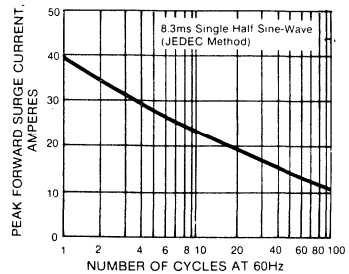

FIGURE 6 — MAXIMUM NON-REPETITIVE SURGE CURRENT



GPP1 & GPP5 SERIES

GLASS PASSIVATED RECTIFIER CHIPS

Voltage - 50 to 1000 Volts Current - 1.0 and 5.0 Amperes

FEATURES

- ◆ Ideal for Hybrid Circuits
- ◆ Solderable Metallization
- ◆ Typical I_R less than $1 \mu A$
- ◆ Glass Passivated Junction
- ◆ High Surge Capability
- ◆ Mounting Position: Any

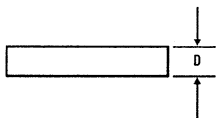
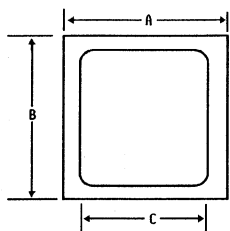

METALLIZATION: GOLD ON NICKEL

	Dimension A	Dimension B	Dimension C	Dimension D
GPP1	.062 (1.6)	.062 (1.6)	.048 (1.2)	.010 (.25)
	.058 (1.5)	.058 (1.5)	.044 (1.1)	.008 (.20)
GPP5	.102 (2.6)	.102 (2.6)	.086 (2.2)	.010 (0.25)
	.098 (2.5)	.098 (2.5)	.082(2.1)	.008 (0.20)

Dimensions in inches and (millimeters)

MAXIMUM RATINGS AND ELECTRICAL CHARACTERISTICS

Ratings at 25°C ambient temperature unless otherwise specified.
Single phase, half wave, 60 Hz, resistive or inductive load.
For capacitive load, derate current by 20%.

	SYMBOLS	GPP1A	GPP1B	GPP1D	GPPG	GPP1J	GPP1K	GPP1M	UNITS	
		GPP5A	GPP5B	GPP5D	GPP5G	GPP5J	GPP5K			
Maximum Recurrent Peak Reverse Voltage	V_{RRM}	50	100	200	400	600	800	1000	Volts	
Maximum RMS Voltage	V_{RMS}	35	70	140	280	420	560	700	Volts	
Maximum DC Blocking Voltage	V_{DC}	50	100	200	400	600	800	1000	Volts	
Maximum Average Forward Rectified Current (Note 1) GPP1 $T_A = 75^\circ C$ GPP5 $T_A = 100^\circ C$	$I_{(AV)}$	1.0						5.0		Amps
Peak Forward Surge Current 8.3ms single half sine wave superimposed on rated load (JEDEC Method) GPP1 GPP5	I_{FSM}	60.0						150.0		Amps
Maximum Instantaneous Forward Voltage at specified current GPP1 $I_F = 1.0A$ GPP5 $I_F = 5.0A$	V_F	1.1						1.1		Volts
Maximum Reverse Leakage Current at Rated DC Blocking Voltage GPP1 GPP5	I_R	5.0						10.0		μA
Operating and Storage Temperature Range	T_J, T_{STG}	-65 to +175								$^\circ C$

NOTES:

1. Actual rating is heat sink dependent.

RATINGS AND CHARACTERISTIC CURVES GPP1A THRU GPP1M GPP5A THRU GPP5K

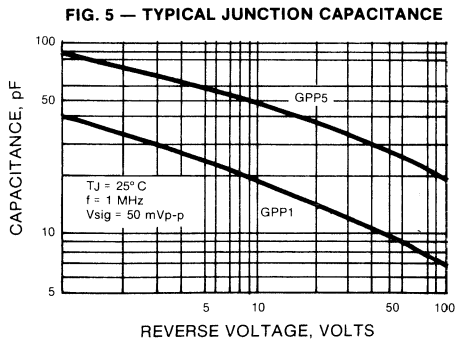
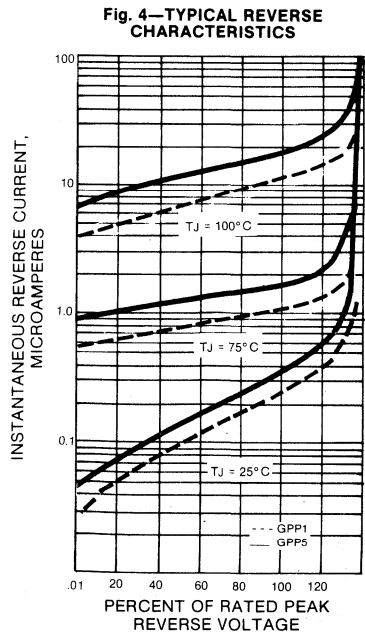
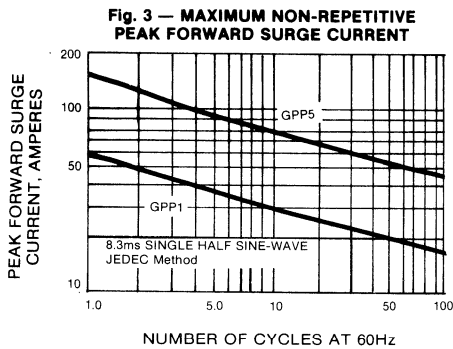
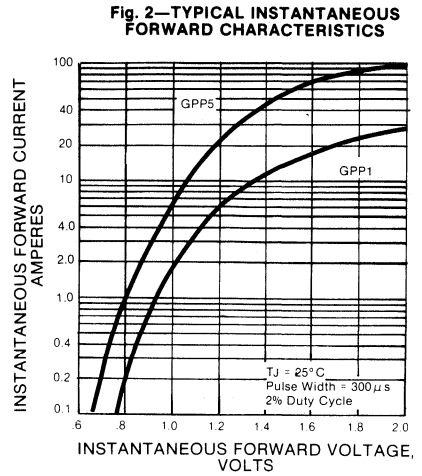
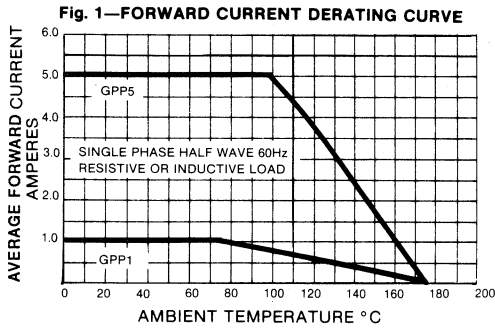

RGPP1 & RGPP5 SERIES

FAST RECOVERY GLASS PASSIVATED RECTIFIER CHIPS

Voltage - 50 to 800 Volts Current - 1.0 and 5.0 Amperes

FEATURES

- ◆ Ideal for Hybrid Circuits
- ◆ Solderable Metallization
- ◆ Glass Passivated Junction
- ◆ High Surge Capability
- ◆ Mounting Position: Any

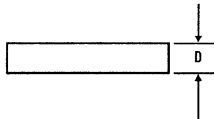
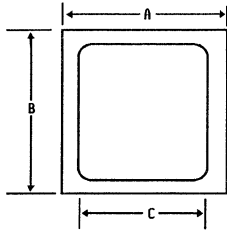

METALLIZATION: GOLD ON NICKEL

	<u>Dimension</u>	<u>Dimension</u>	<u>Dimension</u>	<u>Dimension</u>
	A	B	C	D
RGPP1	.062 (1.6)	.062 (1.6)	.048 (1.2)	.010 (.25)
	.058 (1.5)	.058 (1.5)	.044 (1.1)	.008 (.20)
RGPP5	.102 (2.6)	.102 (2.6)	.082 (2.1)	.012 (0.30)
	.098 (2.5)	.098 (2.5)	.078 (2.0)	.010 (0.25)

Dimensions in inches and (millimeters)

MAXIMUM RATINGS AND ELECTRICAL CHARACTERISTICS

Ratings at 25°C ambient temperature unless otherwise specified.
Single phase, half wave, 60 HZ, resistive or inductive load.
For capacitive load, derate current by 20%.

	RGPP1A RGPP5A	RGPP1B RGPP5B	RGPP1D RGPP5D	RGPP1G RGPP5G	RGPP1J RGPP5J	RGPP1K RGPP5K	UNITS
Maximum Recurrent Peak Reverse Voltage	50	100	200	400	600	800	Volts
Maximum RMS Voltage	35	70	140	280	420	560	Volts
Maximum DC Blocking Voltage	50	100	200	400	600	800	Volts
Maximum Average Forward Rectified Current (Note 1) RGPP1 T _A = 75°C RGPP5 T _A = 100°C	1.0 5.0						Amps
Peak Forward Surge Current 8.3ms single half sine -wave superimposed on rated load (JEDEC Method) RGPP1 RGPP5	30.0 150.0						Amps
Maximum Forward Voltage at Rated Forward Current (Pulse Width = 300 μs, Duty Factor = 1%)	1.3						Volts
Maximum Reverse Leakage Current at Rated DC Blocking Voltage T _A = 25°C RGPP1 RGPP5	10.0 25.0						μA
Maximum Reverse Recovery Time (Note 2)	150		200	250	350		ns
Operating and Storage Temperature Range T _J , T _{STG}	-65 to +150						°C

NOTES:

1. Actual rating is heat sink dependent.
2. Reverse Recovery Test Conditions: I_F = 0.5A, I_R = 1.0A, I_{rr} = 0.25A.

RATINGS AND CHARACTERISTIC CURVES RGPP1A THRU RGPP1K RGPP5A THRU RGPP5K

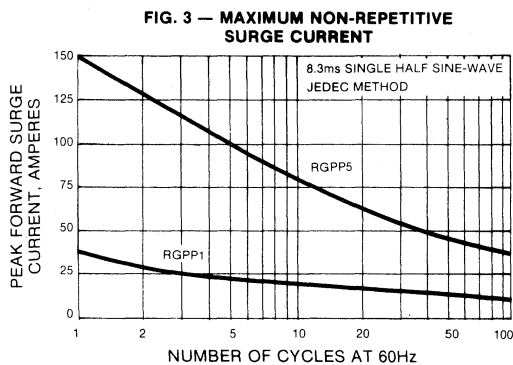
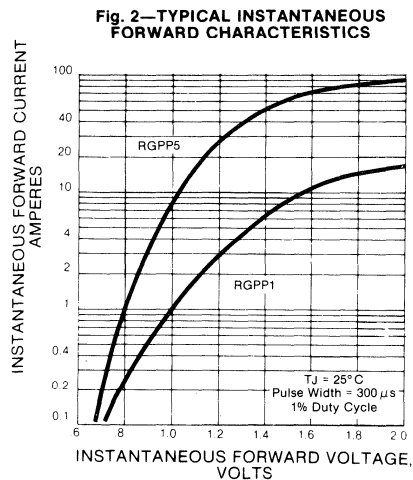
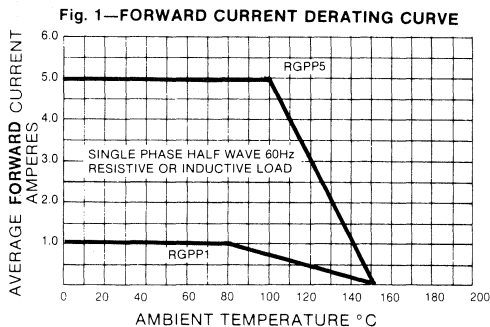

Fig. 4—TYPICAL REVERSE CHARACTERISTICS

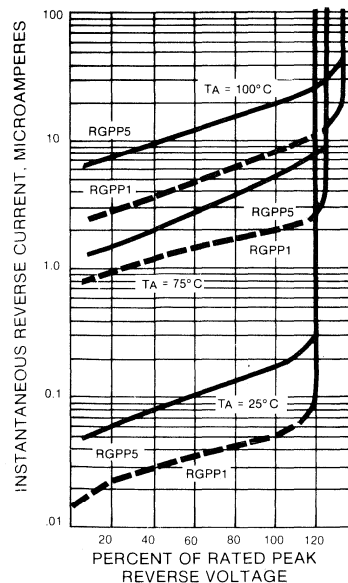
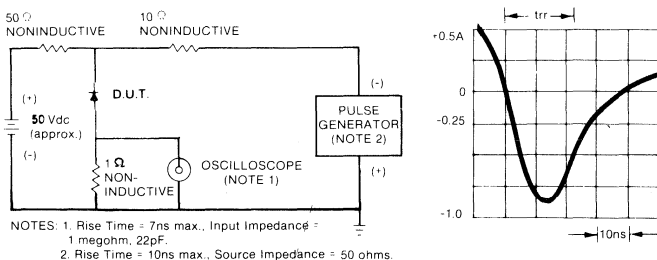

FIG. 1 — REVERSE RECOVERY TIME CHARACTERISTIC AND TEST DIAGRAM



TRANSIENT VOLTAGE SUPPRESSORS

General Instrument Transient Voltage Suppressors are the state-of-the-art in semiconductor surge protection for modern electronic equipment.

Because TVS devices are semiconductors, there is no inherent wear out mechanism. When overstressed, they short circuit at the changing voltage and protect the associated equip-

ment. The clamping voltage is close to the operating voltage enabling a high degree of protection while assuring the devices are off until their operation is required.

General Instrument TVS units are available in four power ranges: 400, 600, 1500, and 5,000 watts with a wide variety of voltages.

**GENERAL
INSTRUMENT**

P4KA SERIES

AUTOMOTIVE TRANSIENT VOLTAGE SUPPRESSOR VOLTAGE- 6.8 to 43 Volts 400 Watt Peak Power 1.0 Watt Steady State

FEATURES

DO-41

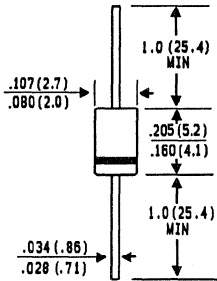

Dimensions in inches
and
(millimeters)

- ◆ Plastic package has Underwriters Laboratory Flammability Classification 94V-0
- ◆ Glass passivated junction
- ◆ Exclusive G.I. PAR construction
- ◆ 400W surge capability at 1 ms
- ◆ Excellent clamping capability
- ◆ Low zener impedance
- ◆ Fast response time: typically less than 1.0 ps from 0 volts to BV min.
- ◆ Typical I_R less than 10 μ A above 10V at 175°C
- ◆ High temperature soldering guaranteed: 300°C/10 seconds/.375", (9.5mm) lead length/5lbs., (2.3 kg) tension
- ◆ Designed to handle under the hood applications

MECHANICAL DATA

- Case :** Molded plastic over a passivated junction
Terminals: Axial leads, solderable per MIL-ST-202, Method 208
Polarity: Color band denoted cathode except Bipolar
Mounting Position: Any
Weight : 0.012 ounce, 0.3 gram

DEVICES FOR BIPOLAR APPLICATIONS

For Bidirectional use C or CA Suffix for types P4KA6.8 thru types P4KA43.
Electrical characteristics apply in both directions

MAXIMUM RATINGS AND CHARACTERISTICS

Ratings at 25°C ambient temperature unless otherwise specified.
Single phase, half wave, 60 Hz, resistive or inductive load.
For capacitive load, derate current by 20%.

RATING	SYMBOL	VALUE	UNITS
Peak Power Dissipation at $T_A = 25^\circ\text{C}$, $T_p = 1\text{ms}$ (Note 1)	Ppk	Minimum 400	Watts
Steady State Power Dissipation at $T_L = 75^\circ\text{C}$ Lead Lengths .375", (9.5mm) (Note 2)	PD	1.0	Watts
Peak Forward Surge Current, 8.3ms Single Half Sine-Wave Superimposed on Rated Load (JEDEC Method) (Note 3)	IFSM	40.0	Amps
Operating and Storage Temperature Range	T_J, T_{STG}	-65 to +185	°C

NOTES:

1. Non-repetitive current pulse, per Fig. 3 and derated above $T_A = 25^\circ\text{C}$ per Fig. 2.
2. Mounted on Copper Leaf area of 1.57 in² (40mm²).
3. 8.3ms single half sine-wave, duty cycle =4 pulses per Minutes maximum



DEVICE	Breakdown Voltage			Working Peak Reverse Voltage at V_{RWM} (Volts)	Maximum Reverse Leakage at V_{RWM} I_R (μ A)	$T_C = 150^\circ\text{C}$ Maximum Reverse Leakage at V_{RWM} I_R (μ A)	Maximum Reverse Current I_{RSM} (Note 2) (Amps)	Maximum Reverse Voltage at I_{RSM} (Clamping Voltage) V_{RSM} (Volts)	Maximum Temperature Coefficient of V_{BR} (% / $^\circ\text{C}$)
	VBR		@ I_T (mA)						
	Volts (Note 1)								
	Min	Max							
P4KA6.8	6.12	7.48	10	5.50	300	1000	39.8	10.8	0.057
P4KA6.8A	6.45	7.14	10	5.80	300	1000	41.0	10.5	0.057
P4KA7.5	6.75	8.25	10	6.05	150	500	36.8	11.7	0.06
P4KA7.5A	7.13	7.88	10	6.40	150	500	38.1	11.3	0.061
P4KA8.2	7.38	9.02	10	6.63	50	200	34.4	12.5	0.065
P4KA8.2A	7.79	8.61	10	7.02	50	200	35.5	12.1	0.065
P4KA9.1	8.19	10.0	1.0	7.37	10	50	32.2	13.8	0.068
P4KA9.1A	8.65	9.55	1.0	7.78	1.0	50	32.1	13.4	0.068
P4KA10	9.00	11.0	1.0	8.10	1.0	10	28.7	15.0	0.073
P4KA10A	9.50	10.5	1.0	8.55	1.0	5.0	29.7	14.5	0.073
P4KA11	9.90	12.1	1.0	8.92	1.0	5.0	26.5	16.2	0.075
P4KA11A	10.5	11.6	1.0	9.40	1.0	5.0	27.6	15.6	0.075
P4KA12	10.8	13.2	1.0	9.72	1.0	5.0	24.9	17.3	0.076
P4KA12A	11.4	12.6	1.0	10.2	1.0	5.0	25.8	16.7	0.078
P4KA13	11.7	14.3	1.0	10.5	1.0	5.0	22.6	19.0	0.081
P4KA13A	12.4	13.7	1.0	11.1	1.0	5.0	23.6	18.2	0.081
P4KA15	13.5	16.3	1.0	12.1	1.0	5.0	19.6	22.0	0.084
P4KA15A	14.3	15.8	1.0	12.8	1.0	5.0	20.3	21.2	0.084
P4KA16	14.4	17.6	1.0	12.9	1.0	5.0	18.3	23.5	0.086
P4KA16A	15.2	16.8	1.0	13.6	1.0	5.0	19.1	22.5	0.086
P4KA18	16.2	19.8	1.0	14.5	1.0	5.0	16.2	26.5	0.088
P4KA18A	17.1	18.9	1.0	15.3	1.0	5.0	16.9	25.5	0.088
P4KA20	18.0	22.0	1.0	16.2	1.0	5.0	14.8	29.1	0.090
P4KA20A	19.0	21.0	1.0	17.0	1.0	5.0	15.5	27.7	0.090
P4KA22	19.8	24.2	1.0	17.8	1.0	5.0	13.5	31.9	0.092
P4KA22A	20.9	23.1	1.0	18.8	1.0	5.0	14.1	30.6	0.092
P4KA24	21.6	26.4	1.0	19.4	1.0	5.0	12.4	34.2	0.094
P4KA24A	22.8	25.2	1.0	20.5	1.0	5.0	13.0	33.2	0.094
P4KA27	24.3	29.7	1.0	21.8	1.0	5.0	11.0	39.1	0.096
P4KA27A	25.7	28.4	1.0	23.1	1.0	5.0	11.5	37.5	0.096
P4KA30	27.0	33.0	1.0	24.3	1.0	5.0	9.9	43.5	0.097
P4KA30A	28.5	31.5	1.0	25.6	1.0	5.0	10.4	41.4	0.097
P4KA33	29.7	36.3	1.0	26.8	1.0	5.0	9.0	47.7	0.098
P4KA33A	31.4	34.7	1.0	28.2	1.0	5.0	9.4	45.7	0.098
P4KA36	32.4	39.6	1.0	29.1	1.0	5.0	8.3	52.0	0.099
P4KA36A	34.2	37.8	1.0	30.8	1.0	5.0	8.6	49.9	0.099
P4KA39	35.1	42.9	1.0	31.6	1.0	5.0	7.6	56.4	0.100
P4KA39A	37.1	41.0	1.0	33.3	1.0	5.0	8.0	53.9	0.100
P4KA43	38.7	47.3	1.0	34.8	1.0	5.0	7.0	61.9	0.101
P4KA43A	40.9	45.2	1.0	36.8	1.0	5.0	7.3	59.3	0.101

NOTES:

1. V_{BR} measured after I_T applied for 300 μ s, I_T = Square Wave Pulse or equivalent.
2. Surge Current Waveform per Figure 3 and Derated per Figure 2.
3. $V_F = 3.5$ V max., $I_F = 25$ A for all types on 1/2 Square or Equivalent Sine Wave
PW = 8.33 ms, Duty Cycle = 4 Pulses per Minute Maximum

RATING AND CHARACTERISTIC CURVES P4KA

FIGURE 1 — PULSE RATING CURVE

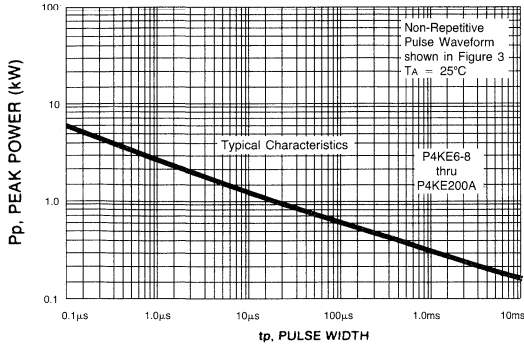

FIGURE 2 — PULSE DERATING CURVE

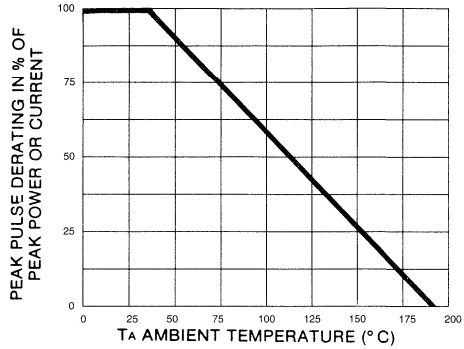

FIGURE 3 — PULSE WAVEFORM

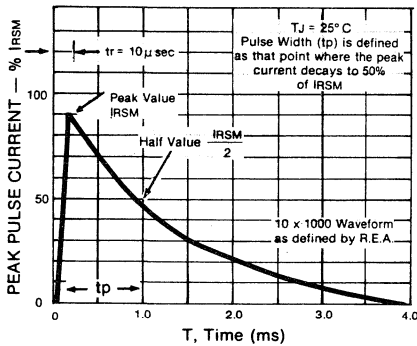

FIGURE 4 — TYPICAL JUNCTION CAPACITANCE

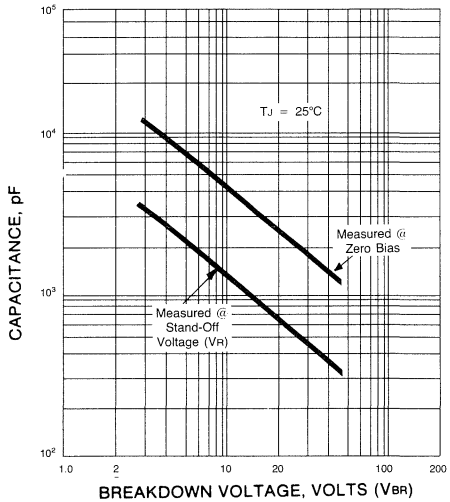

FIGURE 5 — STEADY STATE POWER DERATING

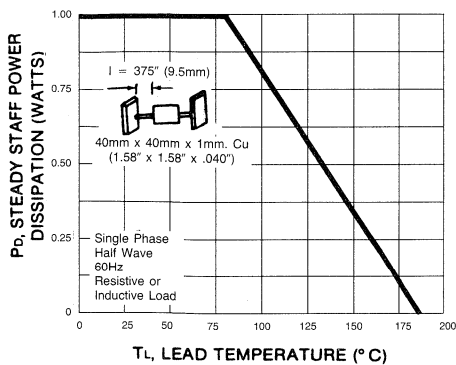
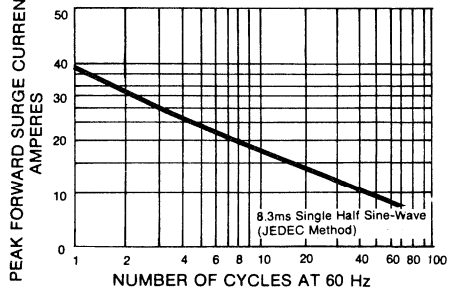

FIGURE 6 — MAXIMUM NON-REPETITIVE SURGE CURRENT



P6KA SERIES

AUTOMOTIVE TRANSIENT VOLTAGE SUPPRESSOR

VOLTAGE- 6.8 to 43 Volts

600 Watt Peak Power 5.0 Watt Steady State

FEATURES

- ◆ Plastic package has Underwriters Laboratory Flammability Classification 94V-0
- ◆ Glass passivated junction
- ◆ Exclusive G.I. PAR construction
- ◆ 600W surge capability at 1 ms
- ◆ Excellent clamping capability
- ◆ Low zener impedance
- ◆ Fast response time: typically less than 1.0 ps from 0 volts to BV min.
- ◆ Typical I_R less than 10 μ A above 10V at 175°C
- ◆ High temperature soldering guaranteed: 300°C/10 seconds/.375", (9.5mm) lead length/5lbs., (2.3 kg) tension
- ◆ Designed to handle under the hood applications

DO-15

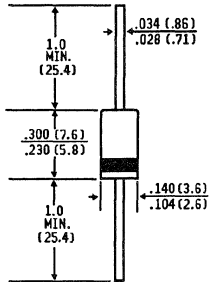

Dimensions in inches
and
(millimeters)

MECHANICAL DATA

Case : Molded plastic over a passivated junction

Terminals: Axial leads, solderable per MIL-ST-202, Method 208

Polarity: Color band denoted cathode except Bipolar

Mounting Position: Any

Weight : 0.015 ounce, 0.4 gram

DEVICES FOR BIPOLAR APPLICATIONS

For Bidirectional use C or CA Suffix for types P6KA6.8 through types P6KA43. Electrical characteristics apply in both directions

MAXIMUM RATINGS AND CHARACTERISTICS

Ratings at 25°C ambient temperature unless otherwise specified.
Single phase, half wave, 60 Hz, resistive or inductive load.
For capacitive load, derate current by 20%.

RATING	SYMBOL	VALUE	UNITS
Peak Power Dissipation at $T_A = 25^\circ\text{C}$, $T_p = 1\text{ms}$ (Note 1)	Ppk	Minimum 600	Watts
Steady State Power Dissipation at $T_L = 75^\circ\text{C}$ Lead Lengths .375", (9.5mm) (Note 2)	PD	5.0	Watts
Peak Forward Surge Current, 8.3ms Single Half Sine-Wave Superimposed on Rated Load (JEDEC Method) (Note 3)	I_{FSM}	100	Amps
Operating and Storage Temperature Range	T_J, T_{STG}	-65 to +185	°C

NOTES:

1. Non-repetitive current pulse, per Fig. 3 and derated above $T_A = 25^\circ\text{C}$ per Fig. 2.
2. Mounted on Copper Leaf area of 1.57 in² (40mm²).
3. 8.3ms single half sine-wave, duty cycle = 4 pulses per Minutes maximum.



ELECTRICAL CHARACTERISTICS ($T_A = 25^\circ\text{C}$ unless otherwise noted)

DEVICE	Breakdown Voltage			Working Peak Reverse Voltage (Volts)	Maximum Reverse Leakage at V_{RWM} I_R (μA)	$T_C = 150^\circ\text{C}$ Maximum Reverse Leakage _{RSM} at V_{RWM} I_R (μA)	Maximum Reverse Current _{RSM} (Note 2) (Amps)	Maximum Reverse Voltage at I_{RSM} (Clamping Voltage) V_{RSM} (Volts)	Maximum Temperature Coefficient of VBR (% / $^\circ\text{C}$)
	VBR		@ I_T (mA)						
	Volts (Note1)	Min							
P6KA6.8	6.12	7.48	10	5.50	500	1000	59.7	10.8	0.057
P6KA6.8A	6.45	7.14	10	5.80	500	1000	61.4	10.5	0.057
P6KA7.5	6.75	8.25	10	6.05	250	500	58.1	11.7	0.061
P6KA7.5A	7.13	7.88	10	6.40	250	500	57.1	11.3	0.061
P6KA8.2	7.38	9.02	10	6.63	100	200	51.6	12.5	0.065
P6KA8.2A	7.79	8.61	10	7.02	100	200	53.3	12.1	0.065
P6KA9.1	8.19	10.0	1.0	7.37	25	50	46.7	13.8	0.068
P6KA9.1A	8.65	9.55	1.0	7.78	25	50	48.1	13.4	0.068
P6KA10	9.00	11.0	1.0	8.10	5.0	10	43.0	15.0	0.073
P6KA10A	9.50	10.5	1.0	8.55	5.0	10	44.5	14.5	0.073
P6KA11	9.90	12.1	1.0	8.92	2.0	5.0	39.8	16.2	0.075
P6KA11A	10.5	11.6	1.0	9.40	2.0	5.0	41.3	15.6	0.076
P6KA12	10.8	13.2	1.0	9.72	2.0	5.0	37.3	17.3	0.076
P6KA12A	11.4	12.6	1.0	10.2	2.0	5.0	38.6	16.7	0.078
P6KA13	11.7	14.3	1.0	10.5	2.0	5.0	35.9	19.0	0.081
P6KA13A	12.4	13.7	1.0	11.1	2.0	5.0	35.4	18.2	0.081
P6KA15	13.5	16.3	1.0	12.1	2.0	5.0	29.3	22.0	0.084
P6KA15A	14.3	15.8	1.0	12.8	2.0	5.0	30.4	21.2	0.084
P6KA16	14.4	17.6	1.0	12.9	2.0	5.0	27.4	23.5	0.086
P6KA16A	15.2	16.8	1.0	13.6	2.0	5.0	28.7	22.5	0.086
P6KA18	16.2	19.8	1.0	14.5	2.0	5.0	24.3	26.5	0.088
P6KA18A	17.1	18.9	1.0	15.3	2.0	5.0	25.6	25.2	0.088
P6KA20	18.0	22.0	1.0	16.2	2.0	5.0	22.2	29.1	0.090
P6KA20A	19.0	21.0	1.0	17.1	2.0	5.0	23.3	27.7	0.090
P6KA22	19.8	24.2	1.0	17.8	2.0	5.0	20.2	31.9	0.092
P6KA22A	20.9	23.1	1.0	18.8	2.0	5.0	21.1	30.6	0.092
P6KA24	21.6	26.4	1.0	19.4	2.0	5.0	18.6	34.7	0.094
P6KA24A	22.8	25.2	1.0	20.5	2.0	5.0	19.4	33.6	0.094
P6KA27	24.3	29.7	1.0	21.8	2.0	5.0	16.5	39.1	0.096
P6KA27A	25.7	28.4	1.0	23.1	2.0	5.0	17.2	37.5	0.096
P6KA30	27.0	33.0	1.0	24.3	2.0	5.0	14.8	43.5	0.097
P6KA30A	28.5	31.5	1.0	25.6	2.0	5.0	15.6	41.4	0.097
P6KA33	29.7	36.3	1.0	26.8	2.0	5.0	13.5	47.7	0.098
P6KA33A	31.4	34.7	1.0	28.2	2.0	5.0	14.1	45.7	0.098
P6KA36	32.4	39.6	1.0	29.1	2.0	5.0	12.4	52.0	0.099
P6KA36A	34.2	37.8	1.0	30.8	2.0	5.0	12.9	49.9	0.099
P6KA39	35.1	42.9	1.0	31.6	2.0	5.0	11.4	56.4	0.100
P6KA39A	37.1	41.0	1.0	33.3	2.0	5.0	12.0	53.9	0.100
P6KA43	38.7	47.3	1.0	34.8	2.0	5.0	10.4	61.9	0.101
P6KA43A	40.9	45.2	1.0	36.8	2.0	5.0	10.9	59.3	0.101

NOTES:

- V_{BR} measured after I_T applied for 300 μs . I_T = Square Wave Pulse or equivalent.
- Surge Current Waveform per Figure 3 and Derate per Figure 2.
- $V_F = 3.5\text{ V max.}$, $I_F = 50\text{ A}$ for all types on 1/2 Square or Equivalent Sine Wave. $PW = 8.3\text{ms}$, Duty Cycle = 4 Pulses per Minute maximum.

RATING AND CHARACTERISTIC CURVES P6KA SERIES

FIGURE 1 — PULSE RATING CURVE

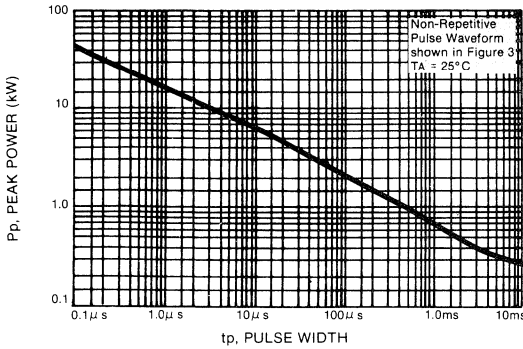

FIGURE 2 — PULSE DERATING CURVE

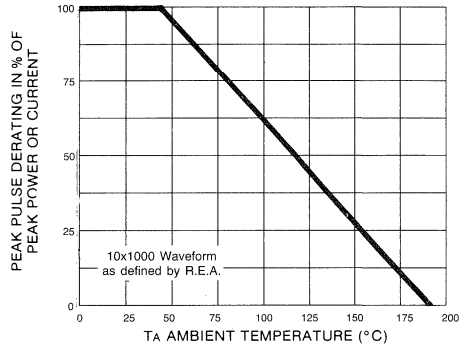

FIGURE 3 — PULSE WAVEFORM

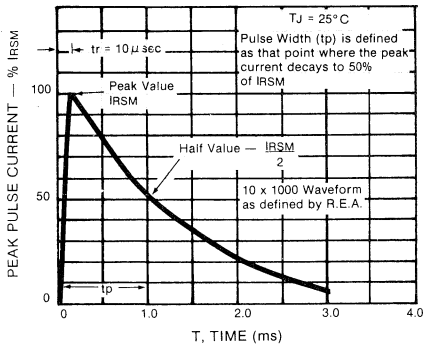

FIGURE 4 — TYPICAL JUNCTION CAPACITANCE

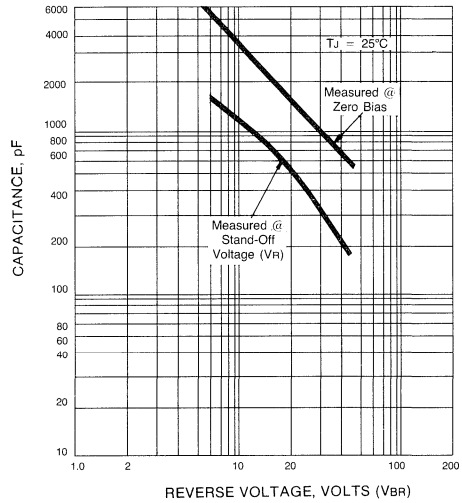

FIGURE 5 — STEADY STATE POWER DERATING

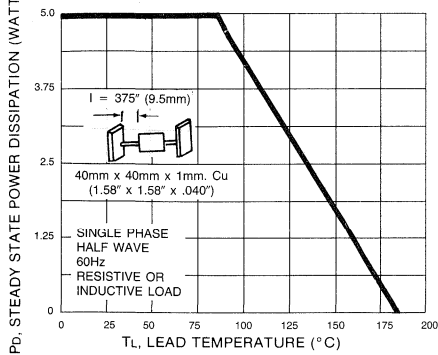
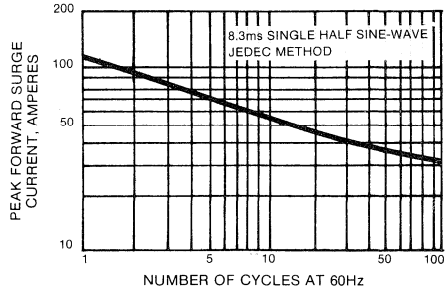

FIGURE 6 — MAXIMUM NON-REPETITIVE SURGE CURRENT



1.5KA SERIES

AUTOMOTIVE TRANSIENT VOLTAGE SUPPRESSOR

VOLTAGE- 6.8 to 43 Volts

1500 Watt Peak Power 5.0 Watt Steady State

FEATURES

- ◆ Plastic package has Underwriters Laboratory Flammability Classification 94V-O
- ◆ Glass passivated junction
- ◆ Exclusive G.I. PAR construction
- ◆ 1500W surge capability at 1 ms
- ◆ Excellent clamping capability
- ◆ Low zener impedance
- ◆ Fast response time: typically less than 1.0 ps from 0 volts to BV min.
- ◆ Typical I_R less than 20 μ A above 10V at 175°C
- ◆ High temperature soldering guaranteed: 300°C/10 seconds/.375", (9.5mm) lead length/5lbs., (2.3 kg) tension
- ◆ Designed to handle under the hood applications



DO-201

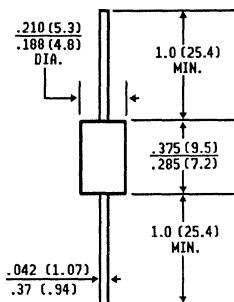

Dimensions in inches and (millimeters)

MECHANICAL DATA

Case : Molded plastic over a passivated junction

Terminals: Axial leads, solderable per MIL-ST-202, Method 208

Polarity: Color band denoted cathode except Bipolar

Mounting Position: Any

Weight : 0.045 ounce, 1.2 grams

DEVICES FOR BIPOLAR APPLICATIONS

For Bidirectional use C or CA Suffix for types 1.5KA6.8 thru types 1.5KA43
Electrical characteristics apply in both directions

MAXIMUM RATINGS AND CHARACTERISTICS

Ratings at 25°C ambient temperature unless otherwise specified.

RATING	SYMBOL	VALUE	UNITS
Peak Power Dissipation at $T_A = 25^\circ\text{C}$, $T_p = 1\text{ms}$ (Note 1)	Ppk	Minimum 1500	Watts
Steady State Power Dissipation at $T_L = 75^\circ\text{C}$ Lead Lengths .375", (9.5mm) (Note 2)	PD	5.0	Watts
Peak Forward Surge Current, 8.3ms Single Half Sine-Wave Superimposed on Rated Load (JEDEC Method) (Note 3)	I_{FSM}	200	Amps
Operating and Storage Temperature Range	T_J, T_{STG}	-65 to +185	°C

NOTES:

1. Non-repetitive current pulse, per Fig. 3 and derated above $T_A = 25^\circ\text{C}$ per Fig. 2.
2. Mounted on Copper Leaf area of 0.79 in² (20mm²).
3. 8.3ms single half sine-wave, duty cycle = 4 pulses per Minutes maximum.



ELECTRICAL CHARACTERISTICS ($T_A = 25^\circ\text{C}$ unless otherwise noted)

DEVICE	Breakdown Voltage			Working Peak Reverse Voltage at V_{RWM} (Volts)	Maximum Reverse Leakage at V_{RWM} $I_{r}(\mu\text{A})$	$T_c = 150^\circ\text{C}$ Maximum Reverse Leakage at V_{RWM} $I_{r}(\mu\text{A})$	Maximum Reverse Current I_{RSM} (Note 2) (Ampe)	Maximum Reverse Voltage at I_{RSM} (Clamping Voltage) V_{RSM} (Volts)	Maximum Temperature Coefficient of V_{BR} (% / $^\circ\text{C}$)
	VBR@		IT (mA)						
	Volts (Note1)								
	MIN	MAX							
1.5KA6.8	6.12	7.48	10	5.50	500	2000	149	10.8	0.057
1.5KA6.8A	6.45	7.14	10	5.80	500	2000	153	10.5	0.057
1.5KA7.5	6.75	8.25	10	6.05	250	1000	137	11.7	0.061
1.5KA7.5A	7.13	7.88	10	6.40	250	1000	143	11.3	0.061
1.5KA8.2	7.38	9.02	10	6.63	100	400	129	12.5	0.065
1.5KA8.2A	7.79	8.61	10	7.02	100	400	133	12.1	0.065
1.5KA9.1	8.19	10.0	1.0	7.37	25	100	117	13.8	0.068
1.5KA9.1A	8.65	9.55	1.0	7.78	25	100	120	13.4	0.068
1.5KA10	9.00	11.0	1.0	8.10	5	20	107	15.0	0.073
1.5KA10A	9.50	10.5	1.0	8.55	5	20	111	14.5	0.073
1.5KA11	9.90	12.1	1.0	8.92	2	10	99.5	16.2	0.075
1.5KA11A	10.5	11.6	1.0	9.40	2	10	103	15.6	0.076
1.5KA12	10.8	13.2	1.0	9.72	2	10	93.2	17.3	0.076
1.5KA12A	11.4	12.6	1.0	10.2	2	10	96.5	19.0	0.078
1.5KA13	11.7	14.3	1.0	10.5	2	10	84.8	18.2	0.081
1.5KA13A	12.4	13.7	1.0	11.1	2	10	88.6	22.0	0.081
1.5KA15	13.5	16.3	1.0	12.1	2	10	73.3	21.2	0.084
1.5KA15A	14.3	15.8	1.0	12.8	2	10	76.0	23.5	0.084
1.5KA16	14.4	17.6	1.0	12.9	2	10	68.6	23.5	0.086
1.5KA16A	15.2	16.8	1.0	13.6	2	10	71.6	22.5	0.086
1.5KA18	16.2	19.8	1.0	14.5	2	10	60.8	26.5	0.088
1.5KA18A	17.1	18.9	1.0	15.3	2	10	64.0	25.2	0.088
1.5KA20	18.0	22.0	1.0	16.2	2	10	55.4	29.1	0.090
1.5KA20A	19.0	21.0	1.0	17.1	2	10	58.2	27.7	0.090
1.5KA22	19.8	24.2	1.0	17.8	2	10	50.5	31.9	0.092
1.5KA22A	20.9	23.1	1.0	18.8	2	10	52.7	30.6	0.092
1.5KA24	21.6	26.4	1.0	19.4	2	10	46.5	34.7	0.094
1.5KA24A	22.8	25.2	1.0	20.5	2	10	48.6	33.2	0.094
1.5KA27	24.3	29.7	1.0	21.8	2	10	41.2	39.1	0.096
1.5KA27A	25.7	28.4	1.0	23.1	2	10	43.4	37.5	0.096
1.5KA30	27.0	33.0	1.0	24.3	2	10	37.0	43.5	0.097
1.5KA30A	28.5	31.5	1.0	25.6	2	10	38.9	41.4	0.097
1.5KA33	29.7	36.3	1.0	26.8	2	10	33.8	47.7	0.098
1.5KA33A	31.4	34.7	1.0	28.2	2	10	35.3	45.7	0.098
1.5KA36	32.4	39.6	1.0	29.1	2	10	31.0	52.0	0.099
1.5KA36A	34.2	37.8	1.0	30.8	2	10	32.3	49.9	0.099
1.5KA39	35.1	42.9	1.0	31.6	2	10	28.6	56.4	0.100
1.5KA39A	37.1	41.0	1.0	33.3	2	10	29.9	53.9	0.100
1.5KA43	38.7	47.3	1.0	34.8	2	10	26.0	61.9	0.101
1.5KA43A	40.9	45.2	1.0	36.8	2	10	27.2	59.3	0.101

NOTES:

1. V_{BR} measured after IT applied for 300 μs . IT = Square Wave Pulse or equivalent.
2. Surge current Waveform per Figure 3 and Derate per Figure 2.
3. $V_F = 3.5\text{V mas.}$, $I_F = 100\text{A}$ for all types per 1/2 Square or Equivalent Sine Wave. PW = 8.3 ms, Duty Cycle = 4 Pulses per Minute Maximum.

RATINGS AND CHARACTERISTIC CURVES 1.5KA SERIES

FIGURE 1 — PULSE RATING CURVE

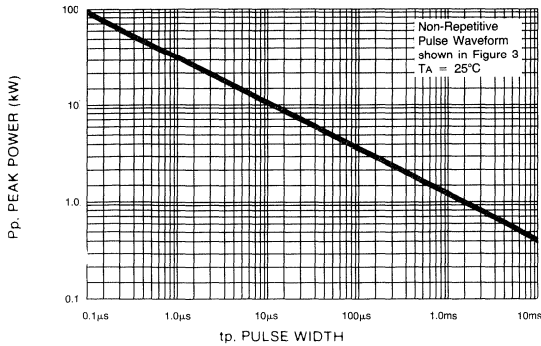

FIGURE 2 — PULSE DERATING CURVE

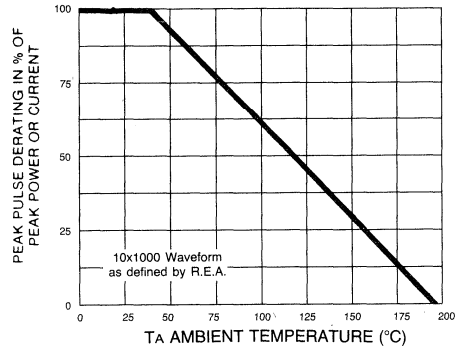

FIGURE 3 — PULSE WAVEFORM

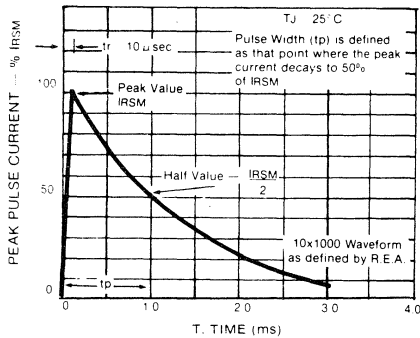

FIGURE 4 — TYPICAL JUNCTION CAPACITANCE

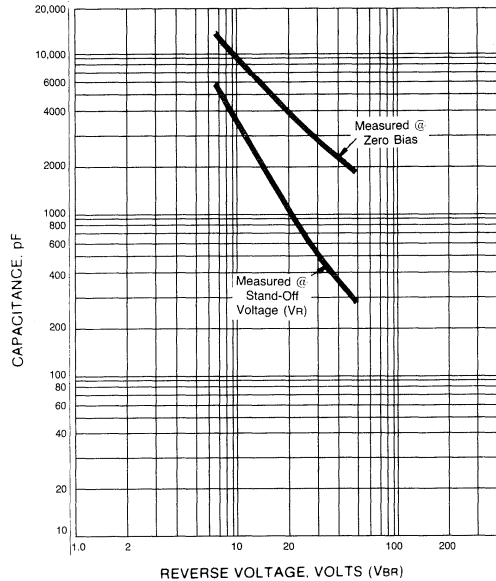

FIGURE 5 — STEADY STATE POWER DERATING

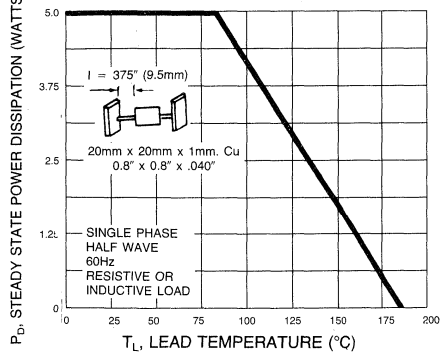
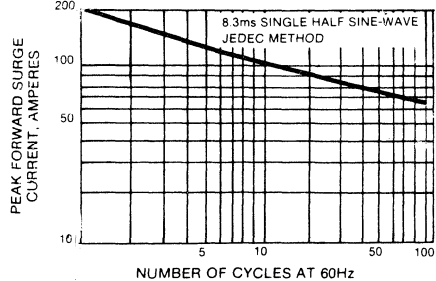

FIGURE 6 — MAXIMUM NON-REPETITIVE SURGE CURRENT



GENERAL INSTRUMENT

P4KE SERIES

GLASS PASSIVATED JUNCTION TRANSIENT VOLTAGE SUPPRESSOR

VOLTAGE- 6.8 to 400 Volts
400 Watt Peak Power 1.0 Watt Steady State

FEATURES

- ◆ Plastic package has Underwriters Laboratory Flammability Classification 94V-O
- ◆ Glass passivated junction in DO-41 package
- ◆ 400W surge capability at 1 ms
- ◆ Excellent clamping capability
- ◆ Low zener impedance
- ◆ Fast response time: typically less than 1.0 ps from 0 volts to BV min.
- ◆ Typical I_R less than 1 μ A above 10V
- ◆ High temperature soldering guaranteed: 300°C/10 seconds/.375", (9.5mm) lead length/5lbs., (2.3 kg) tension

DO-41

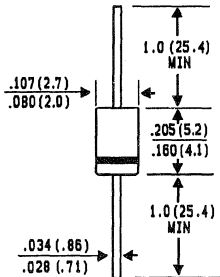

Dimensions in inches
and
(millimeters)

MECHANICAL DATA

Case : Molded plastic over glass passivated junction

Terminals: Axial leads, solderable per MIL-ST-202, Method 208

Polarity: Color band denoted cathode except Bipolar

Mounting Position: Any

Weight : 0.012 ounce, 0.3 gram

DEVICES FOR BIPOLAR APPLICATIONS

For Bidirectional use C or CA Suffix for types P4KE7.5 thru types P4KE400

Electrical characteristics apply in both directions

MAXIMUM RATINGS AND CHARACTERISTICS

Ratings at 25°C ambient temperature unless otherwise specified.

RATING	SYMBOL	VALUE	UNITS
Peak Power Dissipation at $T_A = 25^\circ\text{C}$, $T_p = 1\text{ms}$ (Note 1)	Ppk	Minimum 400	Watts
Steady State Power Dissipation at $T_L = 75^\circ\text{C}$ Lead Lengths .375", (9.5mm) (Note 2)	PD	1.0	Watts
Peak Forward Surge Current, 8.3ms Single Half Sine-Wave Superimposed on Rated Load (JEDEC Method) (Note 3)	I _{FSM}	40.0	Amps
Operating and Storage Temperature Range	T _J , T _{STG}	-65 to +175	°C

NOTES:

1. Non-repetitive current pulse, per Fig. 3 and derated above $T_A = 25^\circ\text{C}$ per Fig. 2.
2. Mounted on Copper Leaf area of 1.57 in² (40mm²).
3. 8.3ms single half sine-wave, duty cycle = 4 pulses per Minutes maximum



Device	Breakdown Voltage			Working Peak Reverse Voltage V_{RWM} (Volts)	Maximum Reverse Leakage at V_{RWM} I_R (μ A)	Maximum Reverse Current I_{RSM} (Note 2) (Amps)	Maximum Reverse Voltage at I_{RSM} (Clamping Voltage) V_{RSM} (Volts)	Maximum Temperature Coefficient of V_{BR} (%C)
	V_{BR} Volts (Note 1)		@IT (mA)					
	MIN	MAX						
P4KE6.8	6.12	7.48	10	5.50	1000	38	10.8	0.057
P4KE6.8A	6.45	7.14	10	5.80	1000	40	10.5	0.057
P4KE7.5	6.75	8.25	10	6.05	500	36	11.7	0.061
P4KE7.5A	7.13	7.88	10	6.40	500	37	11.3	0.061
P4KE8.2	7.38	9.02	10	6.63	200	33	12.5	0.065
P4KE8.2A	7.79	8.61	10	7.02	200	35	12.1	0.065
P4KE9.1	8.19	10.0	1.0	7.37	50	30	13.8	0.068
P4KE9.1A	8.65	9.55	1.0	7.78	50	31	13.4	0.068
P4KE10	9.00	11.0	1.0	8.10	10	28	15.0	0.073
P4KE10A	9.50	10.5	1.0	8.55	10	29	14.5	0.073
P4KE11	9.90	12.1	1.0	8.92	5.0	26	16.2	0.075
P4KE11A	10.5	11.6	1.0	9.40	5.0	27	15.6	0.075
P4KE12	10.8	13.2	1.0	9.72	5.0	24	17.3	0.076
P4KE12A	11.4	12.6	1.0	10.2	5.0	25	16.7	0.078
P4KE13	11.7	14.3	1.0	10.5	5.0	22	19.0	0.081
P4KE13A	12.4	13.7	1.0	11.1	5.0	23	18.2	0.081
P4KE15	13.5	16.3	1.0	12.1	5.0	19	22.0	0.084
P4KE15A	14.3	15.8	1.0	12.8	5.0	20	21.2	0.084
P4KE16	14.4	17.6	1.0	12.9	5.0	18	23.5	0.086
P4KE16A	15.2	16.8	1.0	13.6	5.0	19	22.5	0.086
P4KE18	16.2	19.8	1.0	14.5	5.0	16	26.5	0.088
P4KE18A	17.1	18.9	1.0	15.3	5.0	17	25.5	0.088
P4KE20	18.0	22.0	1.0	16.2	5.0	14	29.1	0.090
P4KE20A	19.0	21.0	1.0	17.1	5.0	15	27.7	0.090
P4KE22	19.8	24.2	1.0	17.8	5.0	13	31.9	0.092
P4KE22A	20.9	23.1	1.0	18.8	5.0	14	30.6	0.092
P4KE24	21.6	26.4	1.0	19.4	5.0	12	34.7	0.094
P4KE24A	22.8	25.2	1.0	20.5	5.0	13	33.2	0.094
P4KE27	24.3	29.7	1.0	21.8	5.0	11	39.1	0.096
P4KE27A	25.7	28.4	1.0	23.1	5.0	11.2	37.5	0.096
P4KE30	27.0	33.0	1.0	24.3	5.0	10	43.5	0.097
P4KE30A	28.5	31.5	1.0	25.6	5.0	10	41.4	0.097
P4KE33	29.7	36.3	1.0	26.8	5.0	9	47.7	0.098
P4KE33A	31.4	34.7	1.0	28.2	5.0	9	45.7	0.098
P4KE36	32.4	39.6	1.0	29.1	5.0	8	52.0	0.099
P4KE36A	34.2	37.8	1.0	30.8	5.0	8.4	49.9	0.099
P4KE39	35.1	42.9	1.0	31.6	5.0	7.4	56.4	0.100
P4KE39A	37.1	41.0	1.0	33.3	5.0	7.8	53.9	0.100
P4KE43	38.7	47.3	1.0	34.8	5.0	6.8	61.9	0.101
P4KE43A	40.9	45.2	1.0	36.8	5.0	7.1	59.3	0.101
P4KE47	42.3	51.7	1.0	38.1	5.0	6.2	67.8	0.101
P4KE47A	44.7	49.4	1.0	40.2	5.0	6.5	64.8	0.101
P4KE51	45.9	56.1	1.0	41.3	5.0	5.7	73.5	0.102
P4KE51A	48.5	53.6	1.0	43.6	5.0	6.0	70.1	0.102
P4KE56	50.4	61.6	1.0	45.4	5.0	5.2	80.5	0.103
P4KE56A	53.2	58.8	1.0	47.8	5.0	5.5	77.0	0.103
P4KE62	55.8	68.2	1.0	50.2	5.0	4.7	89.0	0.104
P4KE62A	58.9	65.1	1.0	53.0	5.0	5.0	85.0	0.104
P4KE68	61.2	74.8	1.0	55.1	5.0	4.3	98.0	0.104
P4KE68A	64.6	71.4	1.0	58.1	5.0	4.6	92.0	0.104
P4KE75	67.5	82.5	1.0	60.7	5.0	3.9	108.0	0.105
P4KE75A	71.3	78.8	1.0	64.1	5.0	4.1	103.0	0.105

Device	Breakdown Voltage			Working Peak Reverse Voltage V _{RWM} (Volts)	Maximum Reverse Leakage at V _{RWM} I _R (μ A)	Maximum Reverse Current I _{RSM} (Note 2) (Amps)	Maximum Reverse Voltage at I _{RSM} (Clamping Voltage) V _{RSM} (Volts)	Maximum Temperature Coefficient of V _{BR} (% C°)
	V _{BR} Volts (Note 1)		@ I _T (mA)					
	MIN	MAX						
P4KE82	73.8	90.2	1.0	66.4	5.0	3.6	118.0	0.105
P4KE82A	77.9	86.1	1.0	70.1	5.0	3.7	113.0	0.105
P4KE91	81.9	100.0	1.0	73.7	5.0	3.2	131.8	0.106
P4KE91A	86.5	95.50	1.0	77.8	5.0	3.4	125.0	0.106
P4KE100	90.0	110.0	1.0	81.0	5.0	2.9	144.0	0.106
P4KE100A	95.0	105.0	1.0	85.5	5.0	3.1	137.0	0.106
P4KE110	99.0	121.0	1.0	89.2	5.0	2.7	158.0	0.107
P4KE110A	105.0	116.0	1.0	94.0	5.0	2.8	152.0	0.107
P4KE120	108.0	132.0	1.0	97.2	5.0	2.4	173.0	0.107
P4KE120A	114.0	126.0	1.0	102.0	5.0	2.5	165.0	0.107
P4KE130	117.0	143.0	1.0	105.0	5.0	2.2	187.0	0.107
P4KE130A	124.0	137.0	1.0	111.0	5.0	2.3	179.0	0.107
P4KE150	135.0	165.0	1.0	121.0	5.0	2.0	215.0	0.108
P4KE150A	143.0	158.0	1.0	128.0	5.0	2.0	207.0	0.108
P4KE160	144.0	176.0	1.0	130.0	5.0	1.8	230.0	0.108
P4KE160A	152.0	168.0	1.0	136.0	5.0	1.9	219.0	0.108
P4KE170	153.0	187.0	1.0	138.0	5.0	1.7	244.0	0.108
P4KE170A	162.0	179.0	1.0	145.0	5.0	1.8	234.0	0.108
P4KE180	162.0	198.0	1.0	146.0	5.0	1.6	258.0	0.108
P4KE180A	171.0	189.0	1.0	154.0	5.0	1.7	246.0	0.108
P4KE200	180.0	220.0	1.0	162.0	5.0	1.5	287.0	0.108
P4KE200A	190.0	210.0	1.0	171.0	5.0	1.53	274.0	0.108
P4KE220	198.0	242.0	1.0	175.0	5.0	1.16	344.0	0.108
P4KE220A	209.0	231.0	1.0	185.0	5.0	1.22	328.0	0.108
P4KE250	225.0	275.0	1.0	202.0	5.0	1.11	360.0	0.110
P4KE250A	237.0	267.0	1.0	214.0	5.0	1.16	344.0	0.110
P4KE300	270.0	330.0	1.0	243.0	5.0	0.93	430.0	0.110
P4KE300A	285.0	315.0	1.0	256.0	5.0	0.97	414.0	0.110
P4KE350	315.0	385.0	1.0	284.0	5.0	0.79	504.0	0.110
P4KE350A	332.0	368.0	1.0	300.0	5.0	0.83	482.0	0.110
P4KE400	360.0	440.0	1.0	324.0	5.0	0.70	574.0	0.110
P4KE400A	380.0	420.0	1.0	342.0	5.0	0.73	548.0	0.110

NOTES:

1. V_{BR} measured after I_T applied for 300 μ s , I_T = Square Wave Pulse or equivalent.
2. Surge Current Waveform per Figure 3 and Derated per Figure 2.
3. V_F = 3.5 V at I_F = 25A (P4KE6.8 thru P4KE91A)
V_F = 5.0 V at I_F = 25A (P4KE100 thru P4KE400A) on 1/2 Square or Equivalent Sine Wave.
PW = 8.3ms, Duty Cycle = 4 Pulses per Minute Maximum
4. For Bipolar types moving V_R of 10 volts and under, the I_R limit is doubled.

RATINGS AND CHARACTERISTIC CURVES P4KE SERIES

FIGURE 1 — PULSE RATING CURVE

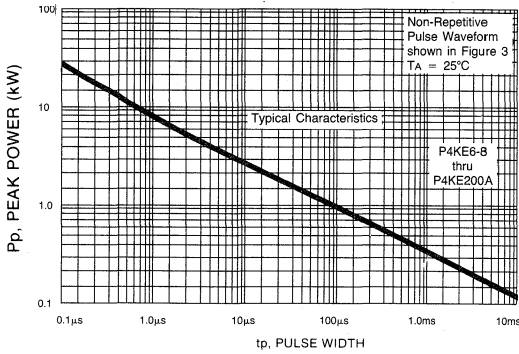

FIGURE 2 — PULSE DERATING CURVE

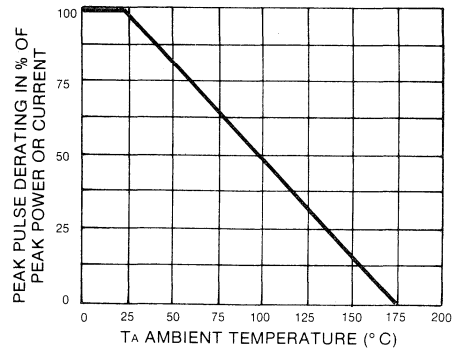

FIGURE 3 — PULSE WAVEFORM

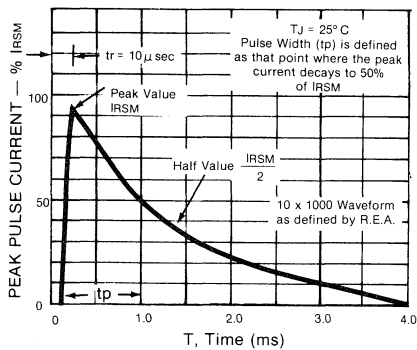

FIGURE 4 — TYPICAL JUNCTION CAPACITANCE

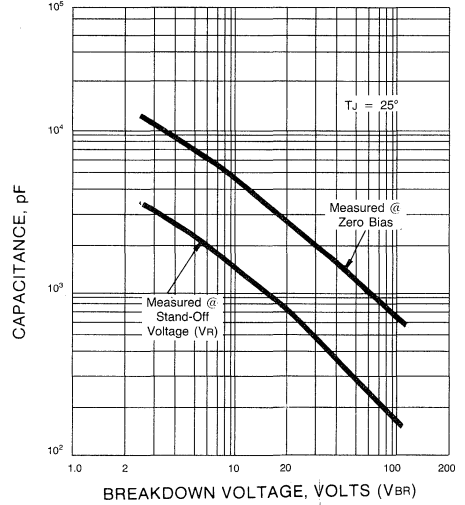

FIGURE 5 — STEADY STATE POWER DERATING

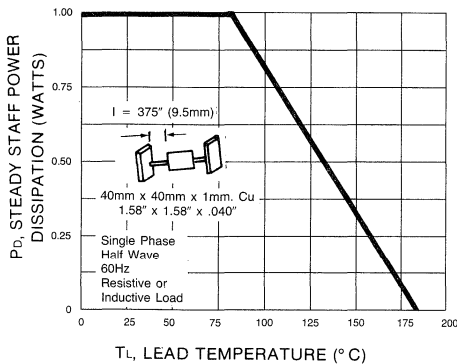
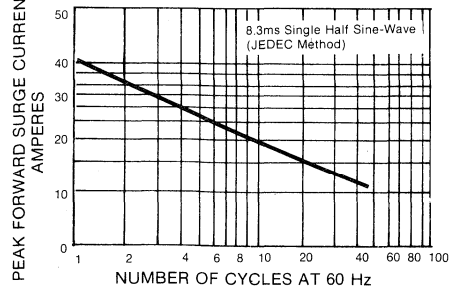

FIGURE 6 — MAXIMUM NON-REPETITIVE SURGE CURRENT



BZW04 SERIES

GLASS PASSIVATED JUNCTION TRANSIENT VOLTAGE SUPPRESSOR

VOLTAGE- 6.8 to 440 Volts
400 Watt Peak Power 1.0 Watt Steady State

FEATURES

- ◆ Plastic package has Underwriters Laboratory Flammability Classification 94V-O
- ◆ Glass passivated junction in DO-41 package
- ◆ 400W surge capability at 1 ms
- ◆ Excellent clamping capability
- ◆ Low zener impedance
- ◆ Fast response time: typically less than 1.0 ps from 0 volts to BV min.
- ◆ Typical I_R less than 1 μ A above 10V
- ◆ High temperature soldering guaranteed: 300°C/10 seconds/.375", (9.5mm) lead length/5lbs., (2.3 kg) tension

DO-41

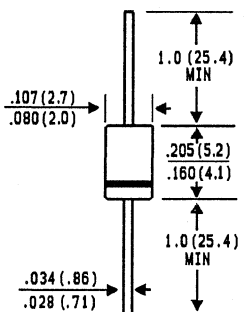

Dimensions in inches
and
(millimeters)

MECHANICAL DATA

Case : Molded plastic over glass passivated junction

Terminals: Axial leads, solderable per MIL-ST-202, Method 208

Polarity: Color band denoted cathode except Bipolar

Mounting Position: Any

Weight : 0.012 ounce, 0.3 gram

DEVICES FOR BIPOLAR APPLICATIONS

For Bidirectional use B.

Electrical characteristics apply in both directions

MAXIMUM RATINGS AND CHARACTERISTICS

Ratings at 25°C ambient temperature unless otherwise specified.

RATING	SYMBOL	VALUE	UNITS
Peak Power Dissipation at $T_A = 25^\circ\text{C}$, $T_p = 1\text{ms}$ (Note 1)	Ppk	Minimum 400	Watts
Steady State Power Dissipation at $T_L = 75^\circ\text{C}$ Lead Lengths .375", (9.5mm) (Note 2)	PD	1.0	Watts
Peak Forward Surge Current, 8.3ms Single Half Sine-Wave Superimposed on Rated Load (JEDEC Method) (Note 3)	IFSM	40.0	Amps
Operating and Storage Temperature Range	T_J, T_{STG}	-65 to +175	$^\circ\text{C}$

NOTES:

1. Non-repetitive current pulse, per Fig. 3 and derated above $T_A = 25^\circ\text{C}$ per Fig. 2.
2. Mounted on Copper Leaf area of 1.57 in² (40mm²).
3. 8.3ms single half sine-wave, duty cycle =4 pulses per Minutes maximum.



Device	Breakdown Voltage		Working Peak Reverse Voltage V_{RWM} (Volts)	Maximum Reverse Leakage at V_{RWM} I_R (μ A)	Maximum Reverse Current I_{RM} (Note 2) (Amps)	Maximum Reverse Voltage at I_{RM} (Clamping Voltage V_{RM} (Volts)	Maximum Temperature Coefficient of V_{BR} (%/C)	
	V_{BR} (Note 1)							@IT (mA)
	MIN	MAX						
BZW04P5V8	6.45	7.48	10	5.8	1000	38	10.5	.057
BZW04-5V8	6.45	7.14	10	5.8	1000	38	10.5	.057
BZW04P6V4	7.13	8.25	10	6.4	500	35.4	11.3	.061
BZW04-6V4	7.13	7.88	10	6.4	500	35.4	11.3	.061
BZW04P7V0	7.79	9.02	10	7.02	200	33	12.1	.065
BZW04-7V0	7.79	8.61	10	7.02	200	33	12.1	.065
BZW04P7V8	8.65	10.0	1	7.78	50	30	13.4	.068
BZW04-7V8	8.65	9.55	1	7.78	50	30	13.4	.073
BZW04P8V5	9.50	11.0	1	8.55	10	27.6	14.5	.073
BZW04-8V5	9.50	10.5	1	8.55	10	27.6	14.5	.075
BZW04P9V4	10.5	12.1	1	9.4	5	25.7	15.6	.075
BZW04P10	11.4	13.2	1	10.2	5	24	16.7	.078
BZW04-10	11.4	12.6	1	10.2	5	24	16.7	.078
BZW04P11	12.4	14.3	1	11.1	5	22	18.2	.081
BZW04-11	12.4	13.7	1	11.1	5	22	18.2	.081
BZW04P13	14.3	16.5	1	12.8	5	19	21.2	.084
BZW04-13	14.3	15.8	1	12.8	5	19	21.2	.084
BZW04P14	15.2	17.6	1	13.6	5	17.8	22.5	.086
BZW04-14	15.2	16.8	1	13.6	5	17.8	22.5	.086
BZW04P15	17.1	19.8	1	15.3	5	16	25.2	.088
BZW04-15	17.1	18.9	1	15.3	5	16	25.2	.088
BZW04P17	19.0	22.0	1	17.1	5	14.5	27.7	.090
BZW04-17	19.0	21.0	1	17.1	5	14.5	27.7	.090
BZW04P19	20.9	24.2	1	18.8	5	13.0	30.6	.092
BZW04-19	20.9	23.1	1	18.8	5	13.0	30.6	.092
BZW04P20	22.8	26.4	1	20.5	5	12.0	33.2	.094
BZW04-20	22.8	25.2	1	20.5	5	12.0	33.2	.094
BZW04P23	25.7	29.7	1	23.1	5	10.7	37.5	.096
BZW04-23	25.7	28.4	1	23.1	5	10.7	37.5	.096
BZW04P26	28.5	33.0	1	25.6	5	9.6	41.5	.097
BZW04-26	28.5	31.5	1	25.6	5	9.6	41.5	.097
BZW04P28	31.4	36.3	1	28.2	5	8.8	45.7	.098
BZW04-28	31.4	34.7	1	28.2	5	8.8	45.7	.098
BZW04P31	34.2	39.6	1	30.8	5	8.0	49.9	.099
BZW04-31	34.2	37.8	1	30.8	5	8.0	49.9	.099
BZW04P33	37.1	42.9	1	33.3	5	7.4	53.9	.100
BZW04-33	37.1	41.0	1	33.3	5	7.4	53.9	.100
BZW04P37	40.9	42.3	1	36.8	5	6.7	59.3	.101
BZW04-37	40.9	45.2	1	36.8	5	6.7	59.3	.101
BZW04P40	44.7	51.7	1	40.2	5	6.2	64.8	.101
BZW04-40	44.7	49.4	1	40.2	5	6.2	64.8	.101
BZW04P44	48.5	56.1	1	43.6	5	5.7	70.1	.102
BZW04-44	48.5	53.6	1	43.6	5	5.7	70.1	.102
BZW04P48	53.2	61.6	1	47.8	5	5.2	77.0	.103
BZW04-48	53.2	58.8	1	47.8	5	5.2	77.0	.103
BZW04P53	58.9	68.2	1	53.0	5	4.7	85.0	.104
BZW04-53	58.9	65.1	1	53.0	5	4.7	85.0	.104
BZW04P58	64.6	74.8	1	58.1	5	4.3	92.0	.104
BZW04-58	64.6	71.4	1	58.1	5	4.3	92.0	.104
BZW04P64	71.3	82.5	1	64.1	5	3.9	103.0	.105
BZW04-64	71.3	78.8	1	64.1	5	3.9	103.0	.105
BZW04P70	77.9	90.2	1	70.1	5	3.5	113.0	.105
BZW04-70	77.9	86.1	1	70.1	5	3.5	113.0	.105
BZW04P78	86.5	100	1	77.8	5	3.2	125.0	.106
BZW04-78	86.5	95.5	1	77.8	5	3.2	125.0	.106

Device	Breakdown Voltage		@IT (mA)	Working Peak Reverse Voltage V _{RWM} (Volts)	Maximum Reverse Leakage at V _{RWM} I _r (μ A)	Maximum Reverse Current I _{RSM} (Note 2) (Amps)	Maximum Reverse Voltage at I _{RSM} (Clamping Voltage V _{RSM} (Volts)	Maximum Temperature Coefficient of VBR (%C)
	VBR							
	MIN	MAX						
BZW04P85	95.0	110	1	85.5	5	2.9	137.0	.106
BZW04-85	95.0	105	1	85.5	5	2.9	137.0	.106
BZW04P94	105	121	1	94.0	5	2.6	152.0	.107
BZW04-94	105	116	1	94.0	5	2.6	152.0	.107
BZW04P102	114	132	1	102.0	5	2.4	165.0	.107
BZW04-102	114	126	1	102.0	5	2.4	165.0	.107
BZW04P111	124	143	1	111.0	5	2.2	179.0	.107
BZW04-111	124	137	1	111.0	5	2.2	179.0	.107
BZW04P128	143	165	1	128.0	5	2.0	207.0	.108
BZW04-128	143	158	1	128.0	5	2.0	207.0	.108
BZW04P136	152	176	1	136.0	5	1.8	219.0	.108
BZW04-136	152	168	1	136.0	5	1.8	219.0	.108
BZW04P145	161	187	1	145.0	5	1.7	234.0	.108
BZW04-145	161	179	1	145.0	5	1.7	234.0	.108
BZW04P154	171	198	1	154.0	5	1.6	246.0	.108
BZW04-154	171	189	1	154.0	5	1.6	246.0	.108
BZW04P171	190	220	1	171.0	5	1.5	274.0	.108
BZW04-171	190	210	1	171.0	5	1.5	274.0	.108
BZW04P188	209	242	1	188.0	5	1.4	301.0	.108
BZW04-188	209	231	1	188.0	5	1.4	301.0	.108
BZW04P213	237	275	1	213.0	5	1.5	344.0	.110
BZW04-213	237	263	1	213.0	5	1.5	344.0	.110
BZW04P239	266	308	1	239.0	5	1.5	384.0	.110
BZW04-239	266	294	1	239.0	5	1.5	384.0	.110
BZW04P256	285	330	1	256.0	5	1.2	414.0	.110
BZW04-256	285	315	1	256.0	5	1.2	414.0	.110
BZW04P273	304	352	1	273.0	5	1.2	438.0	.110
BZW04-273	304	336	1	273.0	5	1.2	438.0	.110
BZW04P299	332	385	1	299.0	5	0.9	482.0	.110
BZW04-299	332	368	1	299.0	5	0.9	482.0	.110
BZW04P342	380	440	1	342.0	5	0.9	548.0	.110
BZW04-342	380	420	1	342.0	5	0.9	548.0	.110
BZW04P376	418	484	1	376.0	5	0.8	603.0	.110
BZW04-376	418	462	1	376.0	5	0.8	603.0	.110

NOTES:

1. V_{BR} measured after I_T applied for 300 μ s, I_T = Square Wave Pulse or equivalent.
2. Surge Current Waveform per Figure 3 and Derated per Figure 2.
3. V_F = 3.5 V at I_F = 25A (BZW04-5V8 thru BZW04-91)
V_F = 5.0 V at I_F = 25A (BZW04P102 thru BZW04-376) on 1/2 Square or Equivalent Sine Wave.
PW = 8.3 ms, Duty Cycle = 4 Pulses per Minute Maximum.

RATINGS AND CHARACTERISTIC CURVES BZW04 SERIES

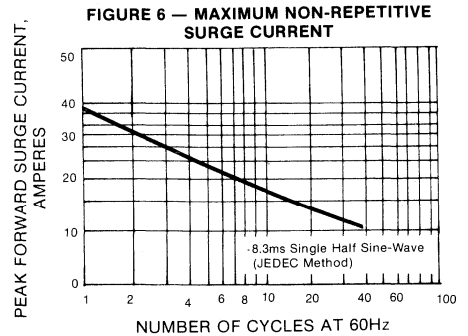
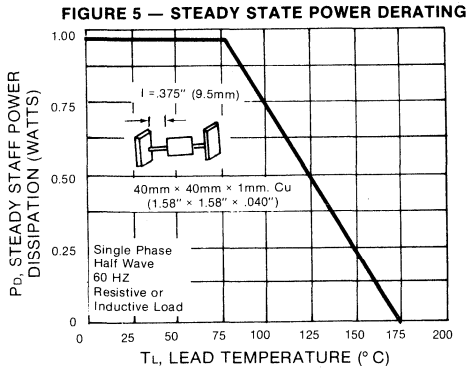
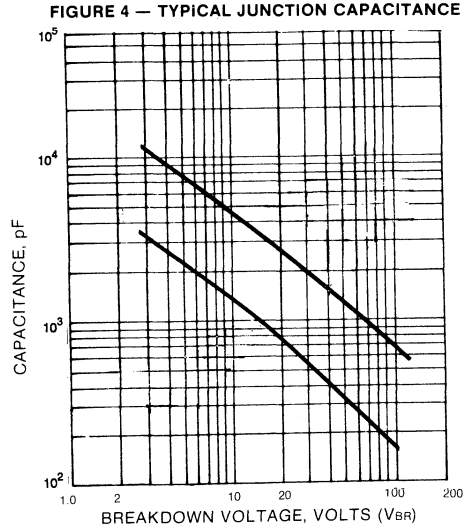
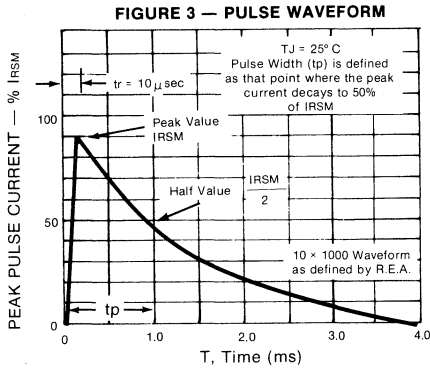
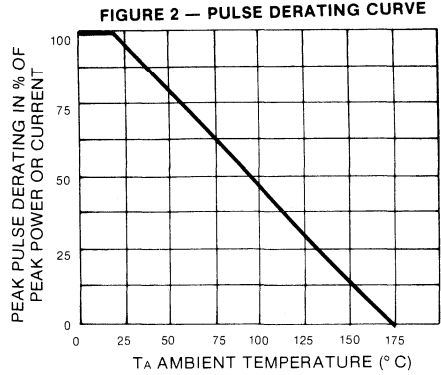
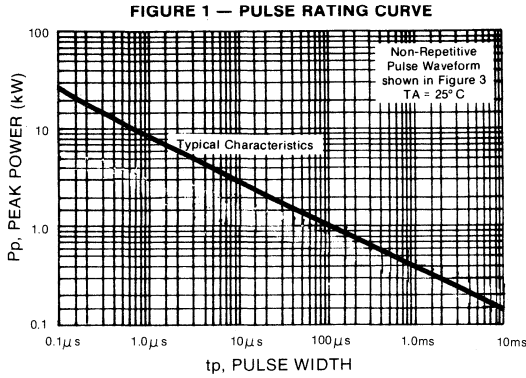

**GENERAL
INSTRUMENT**

P6KE SERIES

GLASS PASSIVATED JUNCTION TRANSIENT VOLTAGE SUPPRESSOR

VOLTAGE- 6.8 to 400 Volts
600 Watt Peak Power 5.0 Watt Steady State

FEATURES

- ◆ Plastic package has Underwriters Laboratory Flammability Classification 94V-O
- ◆ Glass passivated junction in DO-15 package
- ◆ 600W surge capability at 1 ms
- ◆ Excellent clamping capability
- ◆ Low zener impedance
- ◆ Fast response time: typically less than 1.0 ps from 0 volts to BV min.
- ◆ Typical I_R less than 1 μ A above 10V
- ◆ High temperature soldering guaranteed: 300°C/10 seconds/.375", (9.5mm) lead length/5lbs., (2.3 kg) tension



DO-15

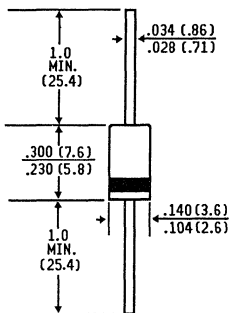

Dimensions in inches
and
(millimeters)

MECHANICAL DATA

Case : Molded plastic over glass passivated junction

Terminals: Axial leads, solderable per MIL-ST-202, Method 208

Polarity: Color band denoted cathode except Bipolar

Mounting Position: Any

Weight : 0.015 ounce, .4 gram

DEVICES FOR BIPOLAR APPLICATIONS

For Bidirectional use C or CA Suffix for types P6KE7.5 thru types P6KE400

Electrical characteristics apply in both directions

MAXIMUM RATINGS AND CHARACTERISTICS

Ratings at 25°C ambient temperature unless otherwise specified.

RATING	SYMBOL	VALUE	UNITS
Peak Power Dissipation at $T_A = 25^\circ\text{C}$, $T_p = 1\text{ ms}$ (Note 1)	Ppk	Minimum 600	Watts
Steady State Power Dissipation at $T_L = 75^\circ\text{C}$ Lead Lengths .375", (9.5mm) (Note 2)	PD	5.0	Watts
Peak Forward Surge Current, 8.3ms Single Half Sine-Wave Superimposed on Rated Load (JEDEC Method) (Note 3)	IFSM	100	Amps
Operating and Storage Temperature Range	T_J, T_{STG}	-65 to +175	°C

NOTES:

1. Non-repetitive current pulse, per Fig. 3 and derated above $T_A = 25^\circ\text{C}$ per Fig. 2.
2. Mounted on Copper Leaf area of 1.57 in² (40mm²).
3. 8.3ms single half sine-wave, duty cycle = 4 pulses per Minutes maximum.



Device	Breakdown Voltage		@IT (mA)	Working Peak Reverse Voltage V _{RWM} (Volts)	Maximum Reverse Leakage at V _{RWM} I _s (μ A)	Maximum Reverse Current I _{RSM} (Note 2) (Amps)	Maximum Reverse Voltage at I _{RSM} (Clamping Voltage) V _{RSU} (Volts)	Maximum Temperature Coefficient of V _{BR} (%C)
	V _{BR} Volts (Note 1)							
	MIN	MAX						
P6KE6.8	6.12	7.48	10	5.50	1000	56	10.8	0.057
P6KE6.8A	6.45	7.14	10	5.80	1000	57	10.5	0.057
P6KE7.5	6.75	8.25	10	6.05	500	51	11.7	0.061
P6KE7.5A	7.13	7.88	10	6.40	500	53	11.3	0.061
P6KE8.2	7.38	9.02	10	6.63	200	48	12.5	0.065
P6KE8.2A	7.79	8.61	10	7.02	200	50	12.1	0.065
P6KE9.1	8.19	10.0	1.0	7.37	50	44	13.8	0.068
P6KE9.1A	8.65	9.55	1.0	7.78	50	45	13.4	0.068
P6KE10	9.00	11.0	1.0	8.10	10	40	15.0	0.073
P6KE10A	9.50	10.5	1.0	8.55	10	41	14.5	0.073
P6KE11	9.90	12.1	1.0	8.92	5.0	37	16.2	0.075
P6KE11A	10.5	11.6	1.0	9.40	5.0	38	15.6	0.075
P6KE12	10.8	13.2	1.0	9.72	5.0	35	17.3	0.078
P6KE12A	11.4	12.6	1.0	10.2	5.0	36	16.7	0.078
P6KE13	11.7	14.3	1.0	10.5	5.0	32	19.0	0.061
P6KE13A	12.4	13.7	1.0	11.1	5.0	33	18.2	0.081
P6KE15	13.5	16.5	1.0	12.1	5.0	27	22.0	0.084
P6KE15A	14.3	15.8	1.0	12.8	5.0	28	21.2	0.084
P6KE16	14.4	17.6	1.0	12.9	5.0	26	23.5	0.086
P6KE16A	15.2	16.8	1.0	13.6	5.0	27	22.5	0.086
P6KE18	16.2	19.8	1.0	14.5	5.0	23	26.5	0.088
P6KE18A	17.1	18.9	1.0	15.3	5.0	24	25.2	0.088
P6KE20	18.0	22.0	1.0	16.2	5.0	21	29.1	0.090
P6KE20A	19.0	21.0	1.0	17.1	5.0	22	27.7	0.090
P6KE22	19.8	24.2	1.0	17.8	5.0	19	31.9	0.092
P6KE22A	20.9	23.1	1.0	18.8	5.0	20	30.6	0.092
P6KE24	21.6	26.4	1.0	19.4	5.0	17	34.7	0.094
P6KE24A	22.8	25.2	1.0	20.5	5.0	18	33.2	0.094
P6KE27	24.3	29.7	1.0	21.8	5.0	15	39.1	0.096
P6KE27A	25.7	28.4	1.0	23.1	5.0	16	37.5	0.096
P6KE30	27.0	33.0	1.0	24.3	5.0	14	43.5	0.097
P6KE30A	28.5	31.5	1.0	25.6	5.0	14.4	41.4	0.097
P6KE33	29.7	36.3	1.0	26.8	5.0	12.6	47.7	0.098
P6KE33A	31.4	34.7	1.0	28.2	5.0	13.2	45.7	0.098
P6KE36	32.4	39.6	1.0	29.1	5.0	11.6	52.0	0.099
P6KE36A	34.2	37.8	1.0	30.8	5.0	12.0	49.9	0.099
P6KE39	35.1	42.9	1.0	31.6	5.0	10.6	56.4	0.100
P6KE39A	37.1	41.0	1.0	33.3	5.0	11.2	53.9	0.100
P6KE43	38.7	47.3	1.0	34.8	5.0	9.6	61.9	0.101
P6KE43A	40.9	45.2	1.0	36.8	5.0	10.1	59.3	0.101
P6KE47	42.3	51.7	1.0	38.1	5.0	8.9	67.8	0.101
P6KE47A	44.7	49.4	1.0	40.2	5.0	9.3	64.8	0.101
P6KE51	45.9	56.1	1.0	41.3	5.0	8.2	73.5	0.102
P6KE51A	48.5	53.6	1.0	43.6	5.0	8.6	70.1	0.102
P6KE56	50.4	61.6	1.0	45.4	5.0	7.4	80.5	0.103
P6KE56A	53.2	58.8	1.0	47.8	5.0	7.8	77.0	0.103
P6KE62	55.8	68.2	1.0	50.2	5.0	6.8	89.0	0.104
P6KE62A	58.9	65.1	1.0	53.0	5.0	7.1	85.0	0.104
P6KE68	61.2	74.8	1.0	55.1	5.0	6.1	98.0	0.104
P6KE68A	64.6	71.4	1.0	58.1	5.0	6.5	92.0	0.104
P6KE75	67.5	82.5	1.0	60.7	5.0	5.5	108.0	0.105
P6KE75A	71.3	78.8	1.0	64.1	5.0	5.8	103.0	0.105

Device	Breakdown Voltage			Working Peak Reverse Voltage V_{RWM} (Volts)	Maximum Reverse Leakage at V_{RWM} I_{R1} (μ A)	Maximum Reverse Current I_{RSM} (Note 2) (Amps)	Maximum Reverse Voltage at I_{RSM} (Clamping Voltage) V_{RSM} (Volts)	Maximum Temperature Coefficient of V_{BR} (%)
	V_{BR} Volts (Note 1)		$@I_T$ (mA)					
	MIN	MAX						
P6KE82	73.8	90.2	1.0	66.4	5.0	5.1	118.0	0.105
P6KE82A	77.9	86.1	1.0	70.1	5.0	5.3	113.0	0.105
P6KE91	81.9	100.0	1.0	73.7	5.0	4.5	131.8	0.106
P6KE91A	86.5	95.5	1.0	77.8	5.0	4.8	125.0	0.106
P6KE100	90.0	110.0	1.0	81.0	5.0	4.2	144.0	0.106
P6KE100A	95.0	105.0	1.0	85.5	5.0	4.4	137.0	0.106
P6KE110	99.0	121.0	1.0	89.2	5.0	3.8	158.0	0.107
P6KE110A	105.0	116.0	1.0	94.0	5.0	4.0	152.0	0.107
P6KE120	108.0	132.0	1.0	97.2	5.0	3.5	173.0	0.107
P6KE120A	114.0	126.0	1.0	102.0	5.0	3.6	165.0	0.107
P6KE130	117.0	143.0	1.0	105.0	5.0	3.2	187.0	0.107
P6KE130A	124.0	137.0	1.0	111.0	5.0	3.3	179.0	0.107
P6KE150	135.0	165.0	1.0	121.0	5.0	2.8	215.0	0.108
P6KE150A	143.0	158.0	1.0	128.0	5.0	2.9	207.0	0.108
P6KE160	144.0	176.0	1.0	130.0	5.0	2.6	230.0	0.108
P6KE160A	152.0	168.0	1.0	136.0	5.0	2.7	219.0	0.108
P6KE170	153.0	187.0	1.0	138.0	5.0	2.5	244.0	0.108
P6KE170A	162.0	179.0	1.0	145.0	5.0	2.6	234.0	0.108
P6KE180	162.0	198.0	1.0	146.0	5.0	2.3	258.0	0.108
P6KE180A	171.0	189.0	1.0	154.0	5.0	2.4	246.0	0.108
P6KE200	180.0	220.0	1.0	162.0	5.0	2.1	287.0	0.108
P6KE200A	190.0	210.0	1.0	171.0	5.0	2.2	274.0	0.108
P6KE220	198.0	242.0	1.0	175.0	5.0	1.75	344.0	0.108
P6KE220A	209.0	231.0	1.0	185.0	5.0	1.83	328.0	0.108
P6KE250	225.0	275.0	1.0	202.0	5.0	1.67	360.0	0.110
P6KE250A	237.0	263.0	1.0	214.0	5.0	1.75	344.0	0.110
P6KE300	270.0	330.0	1.0	243.0	5.0	1.4	430.0	0.110
P6KE300A	285.0	315.0	1.0	256.0	5.0	1.45	414.0	0.110
P6KE350	315.0	385.0	1.0	284.0	5.0	1.2	504.0	0.110
P6KE350A	332.0	368.0	1.0	300.0	5.0	1.25	482.0	0.110
P6KE400	360.0	440.0	1.0	324.0	5.0	1.05	574.0	0.110
P6KE400A	380.0	420.0	1.0	342.0	5.0	1.1	548.0	0.110

NOTES:

- V_{BR} measured after I_T applied for 300 μ s, I_T = Square Wave Pulse or equivalent.
- Surge Current Waveform per Figure 3 and Derated per Figure 2.
- V_F = 9.5 V at I_F = 50A (P6KE6.8 thru P6KE91A)
 V_F = 5.0V at I_F = 50A (P6KE100 thru P6KE400A) on 1/2 Square or Equivalent Sine Wave
PW = 8.3 ms, Duty Cycle = 4 Pulses per Minute Maximum
- For bipolar types moving V_R of 10 volts and under, the I_R limit is doubled.

RATINGS AND CHARACTERISTIC CURVES P6KE SERIES

FIGURE 1 — PULSE RATING CURVE

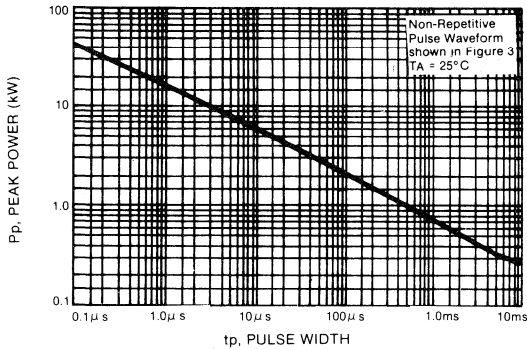

FIGURE 2 — PULSE DERATING CURVE

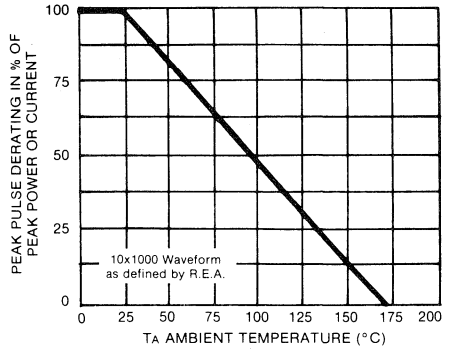

FIGURE 3 — PULSE WAVEFORM

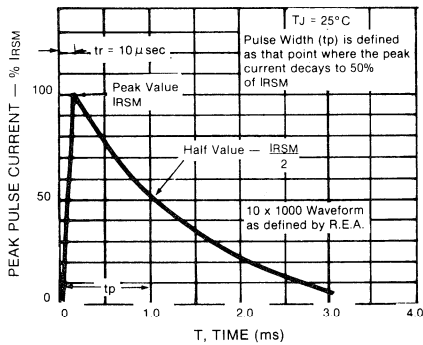

FIGURE 4 — TYPICAL JUNCTION CAPACITANCE

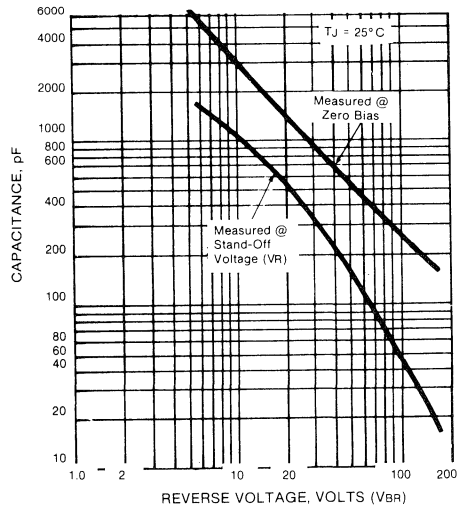

FIGURE 5 — STEADY STATE POWER DERATING

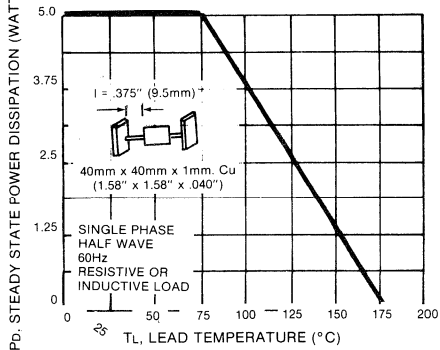
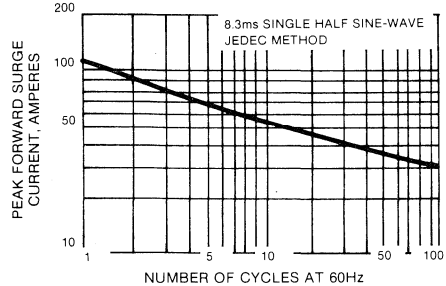

FIGURE 6 — MAXIMUM NON-REPETITIVE SURGE CURRENT



1.5KE SERIES

GLASS PASSIVATED JUNCTION TRANSIENT VOLTAGE SUPPRESSOR

VOLTAGE- 6.8 to 400 Volts
1500 Watt Peak Power 5.0 Watt Steady State

FEATURES

- ◆ Plastic package has Underwriters Laboratory Flammability Classification 94V-O
- ◆ Glass passivated junction in Molded Plastic package
- ◆ 1500W surge capability at 1 ms
- ◆ Excellent clamping capability
- ◆ Low zener impedance
- ◆ Fast response time: typically less than 1.0 ps from 0 volts to BV min.
- ◆ Typical I_R less than 1 μ A above 10V
- ◆ High temperature soldering guaranteed: 300°C/10 seconds/.375", (9.5mm) lead length/5lbs., (2.3 kg) tension

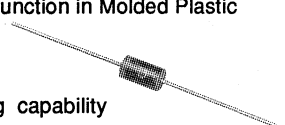

DO-201

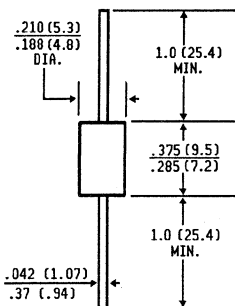

Dimensions in inches
and
millimeters)

MECHANICAL DATA

Case : Molded plastic over glass passivated junction

Terminals: Axial leads, solderable per MIL-STD-202, Method 208

Polarity: Color band denoted cathode except Bipolar

Mounting Position: Any

Weight : 0.045 ounce, 1.2 grams

DEVICES FOR BIPOLAR APPLICATIONS

For Bidirectional use C or CA Suffix for types 1.5KE7.5 thru types 1.5KE400
 Electrical characteristics apply in both directions

MAXIMUM RATINGS AND CHARACTERISTICS

Ratings at 25°C ambient temperature unless otherwise specified.

RATING	SYMBOL	VALUE	UNITS
Peak Power Dissipation at $T_A = 25^\circ\text{C}$, $T_p = 1\text{ms}$ (Note 1)	Ppk	Minimum 1500	Watts
Steady State Power Dissipation at $T_L = 75^\circ\text{C}$ Lead Lengths .375", (9.5mm) (Note 2)	PD	5.0	Watts
Peak Forward Surge Current, 8.3ms Single Half Sine-Wave Superimposed on Rated Load (JEDEC Method) (Note 3)	IFSM	200	Amps
Operating and Storage Temperature Range	T_J, T_{STG}	-65 to +175	°C

NOTES:

1. Non-repetitive current pulse, per Fig. 3 and derated above $T_A = 25^\circ\text{C}$ per Fig. 2.
2. Mounted on Copper Leaf area of 0.79 in² (20mm²).
3. 8.3ms single half sine-wave, duty cycle = 4 pulses per Minutes maximum



JEDEC TYPE NUMBER	GENERAL PART NUMBER	Breakdown Voltage* V _{BR}		@T (mA)	Working Peak Reverse Voltage V _{RRM} (Volts)	Maximum Reverse Leakage at V _{RRM} I _R (µA)	Maximum Reverse Surge Current I _{RSM} (Note 2) (Amps)	Maximum Reverse Voltage at I _{RSM} (Clamping Voltage) V _{RSM} (Volts)	Maximum Temperature Coefficient of V _{BR} (%/°C) V _{BR} (Volts)
		(Volts)	(Note 1)						
		Min	Max						
1N6267	1.5KE6.8	6.12	7.48	10	5.50	1000	139	10.8	0.057
1N6267A	1.5KE6.8A	6.45	7.14	10	5.80	1000	143	10.5	0.057
1N6268	1.5KE7.5	6.75	8.25	10	6.05	500	128	11.7	0.061
1N6268A	1.5KE7.5A	7.13	7.88	10	6.40	500	132	11.3	0.061
1N6269	1.5KE8.2	7.98	9.02	10	6.63	200	120	12.5	0.065
1N6269A	1.5KE8.2A	7.79	8.0	10	7.02	200	124	12.1	0.065
1N6270	1.5KE9.1	8.19	10.0	1.0	7.37	50	109	13.8	0.068
1N6270A	1.5KE9.1A	8.65	9.55	1.0	7.78	50	112	13.4	0.068
1N6271	1.5KE10	9.00	11.0	1.0	8.10	10	100	15.0	0.073
1N6271A	1.5KE10A	9.50	10.5	1.0	8.55	10	103	14.5	0.073
1N6272	1.5KE11	9.90	12.1	1.0	8.92	5.0	93.0	16.2	0.075
1N6272A	1.5KE11A	10.5	11.6	1.0	9.40	5.0	96.0	15.6	0.075
1N6273	1.5KE12	10.8	13.2	1.0	9.72	5.0	87.0	17.3	0.076
1N6273A	1.5KE12A	11.4	12.6	1.0	10.2	5.0	90.0	16.7	0.078
1N6274	1.5KE13	11.7	14.3	1.0	10.5	5.0	79.0	19.0	0.081
1N6274A	1.5KE13A	12.4	13.7	1.0	11.1	5.0	82.0	18.2	0.061
1N6275	1.5KE15	13.5	16.5	1.0	12.1	5.0	68.0	22.0	0.084
1N6275A	1.5KE15A	14.3	15.8	1.0	12.8	5.0	71.0	21.2	0.084
1N6276	1.5KE16	14.4	17.6	1.0	12.9	5.0	64.0	23.5	0.066
1N6276A	1.5KE16A	15.2	16.8	1.0	13.6	5.0	67.0	22.5	0.066
1N6277	1.5KE18	16.2	19.8	1.0	14.5	5.0	56.5	26.5	0.068
1N6277A	1.5KE18A	17.1	18.9	1.0	15.3	5.0	59.5	26.2	0.089
1N6278	1.5KE20	18.0	22.0	1.0	16.2	5.0	51.5	29.1	0.090
1N6278A	1.5KE20A	19.0	21.0	1.0	17.1	5.0	54.0	27.7	0.090
1N6279	1.5KE22	19.8	24.2	1.0	17.8	5.0	47.0	31.9	0.092
1N6279A	1.5KE22A	20.9	23.1	1.0	18.8	5.0	49.0	30.6	0.092
1N6280	1.5KE24	21.6	26.4	1.0	19.4	5.0	43.0	34.7	0.094
1N6280A	1.5KE24A	22.8	25.2	1.0	20.5	5.0	45.0	33.2	0.094
1N6281	1.5KE27	24.3	29.7	1.0	21.8	5.0	38.5	39.1	0.096
1N6281A	1.5KE27A	25.7	28.4	1.0	23.1	5.0	40.0	37.5	0.096
1N6282	1.5KE30	27.0	33.0	1.0	24.3	5.0	34.5	43.5	0.097
1N6282A	1.5KE30A	28.5	31.5	1.0	25.6	5.0	36.0	41.4	0.097
1N6283	1.5KE33	29.7	36.3	1.0	26.8	5.0	31.5	47.7	0.098
1N6283A	1.5KE33A	31.4	34.7	1.0	28.2	5.0	33.0	45.7	0.098
1N6284	1.5KE36	32.4	39.6	1.0	29.1	5.0	29.0	52.0	0.099
1N6284A	1.5KE36A	34.2	37.8	1.0	30.8	5.0	30.0	49.9	0.099
1N6285	1.5KE39	35.1	42.9	1.0	31.6	5.0	26.5	56.4	0.100
1N6285A	1.5KE39A	37.1	41.0	1.0	33.3	5.0	28.0	53.9	0.100
1N6286	1.5KE43	38.7	47.3	1.0	34.8	5.0	24.0	61.9	0.101
1N6286A	1.5KE43A	40.9	45.2	1.0	36.8	5.0	25.3	59.3	0.101
1N6287	1.5KE47	42.3	51.7	1.0	36.1	5.0	22.2	67.8	0.101
1N6287A	1.5KE47A	44.7	49.4	1.0	40.2	5.0	23.2	64.8	0.101
1N6288	1.5KE51	45.9	56.1	1.0	41.3	5.0	20.4	73.5	0.102
1N6288A	1.5KE51A	48.5	53.6	1.0	43.6	5.0	21.4	70.1	0.102
1N6289	1.5KE56	50.4	61.8	1.0	45.4	5.0	18.6	80.5	0.103
1N6289A	1.5KE56A	53.2	58.8	1.0	47.8	5.0	19.5	77.0	0.103
1N6290	1.5KE62	55.8	68.2	1.0	50.2	5.0	16.9	89.0	0.104
1N6290A	1.5KE62A	58.9	65.1	1.0	53.0	5.0	17.7	85.0	0.104
1N6291	1.5KE68	61.2	74.8	1.0	55.1	5.0	15.3	98.0	0.104
1N6291A	1.5KE68A	64.6	71.4	1.0	58.1	5.0	16.3	92.0	0.104
1N6292	1.5KE75	67.5	82.5	1.0	60.7	5.0	13.9	108.9	0.105
1N6292A	1.5KE75A	71.3	78.8	1.0	64.1	5.0	14.6	103.9	0.105
1N6293	1.5KE82	73.8	90.2	1.0	66.4	5.0	12.7	118.0	0.105
1N6293A	1.5KE82A	77.9	86.1	1.0	70.1	5.0	13.3	113.0	0.105
1N6294	1.5KE91	81.9	100.0	1.0	73.7	5.0	11.4	131.0	0.106

JEDEC TYPE NUMBER	GENERAL PART NUMBER	Breakdown Voltage* V _{BR}		@T (mA)	Working Peak Reverse Voltage V _{RRM} (Volts)	Maximum Reverse Leakage at V _{RRM} I _R (μA)	Maximum Reverse Surge Current I _{RSM} (Note 2) (Amps)	Maximum Reverse Voltage at I _{RSM} Clamping Voltage) V _{RRM} (Volts)	Maximum Temperature Coefficient of V _{BR} (%/°C)V _{RRM} (Volts)
		(Volts)	(Note 1)						
		Min	Max						
1N6294A	1.5KE91A	86.5	95.5	1.0	77.8	5.0	12.0	125.0	0.106
1N6295	1.5KE100	90.0	110.0	1.0	81.0	5.0	10.4	144.0	0.106
1N6295A	1.5KE100A	95.0	105.0	1.0	85.5	5.0	11.0	137.0	0.106
1N6296	1.5KE110	99.0	121.0	1.0	89.2	5.0	9.5	158.0	0.107
1N6296A	1.5KE110A	106.0	116.0	1.0	94.0	5.0	9.9	152.0	0.107
1N6297	1.5KE120	108.0	132.0	1.0	97.2	5.0	8.7	173.0	0.107
1N6297A	1.5KE120A	114.0	126.0	1.0	102.0	5.0	9.1	165.0	0.107
1N6298	1.5KE130	117.0	143.0	1.0	106.0	5.0	8.0	187.0	0.107
1N6298A	1.5KE130A	124.0	137.0	1.0	111.0	5.0	8.4	179.0	0.107
1N6299	1.5KE150	136.0	165.0	1.0	121.0	5.0	7.0	215.0	0.108
1N6299A	1.5KE150A	143.0	158.0	1.0	128.0	5.0	7.2	207.0	0.106
1N6300	1.5KE160	144.0	176.0	1.0	130.0	5.0	6.5	230.0	0.106
1N6300A	1.5KE160A	152.0	168.0	1.0	136.0	5.0	6.8	219.0	0.108
1N6301	1.5KE170	153.0	167.0	1.0	138.0	5.0	6.2	244.0	0.108
1N6301A	1.5KE170A	162.0	179.0	1.0	145.0	5.0	6.4	234.0	0.108
1N6302	1.5KE180	162.0	198.0	1.0	146.0	5.0	5.8	258.0	0.108
1N6302A	1.5KE180A	171.0	189.0	1.0	154.0	5.0	6.1	246.0	0.108
1N6303	1.5KE200	180.0	220.0	1.0	162.0	5.0	5.2	287.0	0.108
1N6303A	1.5KE200A*	190.0	210.0	1.0	171.0	5.0	5.5	274.0	0.108
	1.5KE220	196.0	242.0	1.0	175.0	5.0	4.3	344.0	0.108
	1.5KE220A*	209.0	231.0	1.0	185.0	5.0	4.6	328.0	0.108
	1.5KE250	225.0	275.0	1.0	202.0	5.0	5.0	360.0	0.110
	1.5KE250A	237.0	263.0	1.0	214.0	5.0	5.0	344.0	0.110
	1.5KE300	270.0	330.0	1.0	243.0	5.0	5.0	430.0	0.110
	1.5KE300A	285.0	315.0	1.0	256.0	5.0	5.0	414.0	0.110
	1.5KE350	315.0	385.0	1.0	284.0	5.0	4.0	504.0	0.110
	1.5KE350A	333.0	368.0	1.0	300.0	5.0	4.0	482.0	0.110
	1.5KE400	360.0	440.0	1.0	324.0	5.0	4.0	574.0	0.110
	1.5KE400A	380.0	420.0	1.0	342.0	5.0	4.0	548.0	0.110

NOTES:

- V_{BR} measured after I_T applied for 300 μs, I_T = Square Wave Pulse or equivalent.
- Surge Current Waveform per Figure 3 and Derated per Figure 2.
- V_F = 3.5 V max., I_F = 100A (1.5KE 6.8 thru 1.5KE91A)
V_F = 5.0 V max., I_F 100A (1.5KE100 thru 1.5KE400A) per 1/2 Square or Equivalent Sine Wave
PW = 8.3 ms, Duty Cycle = 4 Pulses per Minute Maximum
* Bidirectional versions are UL approved

RATINGS AND CHARACTERISTIC CURVES 1.5KE SERIES

FIGURE 1 — PULSE RATING CURVE

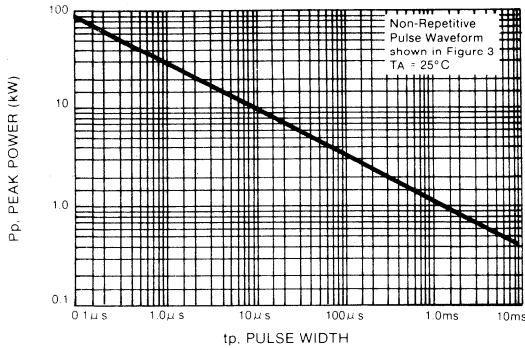

FIGURE 2 — PULSE DERATING CURVE

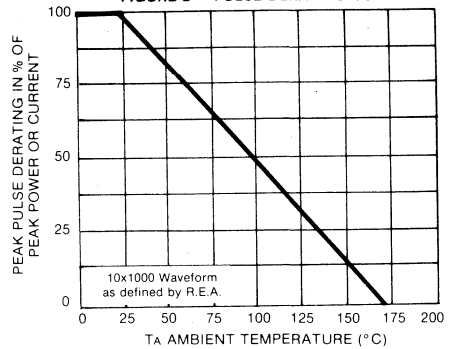

FIGURE 3 — PULSE WAVEFORM

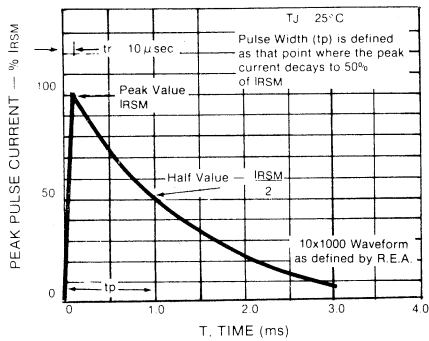

FIGURE 4 — TYPICAL JUNCTION CAPACITANCE

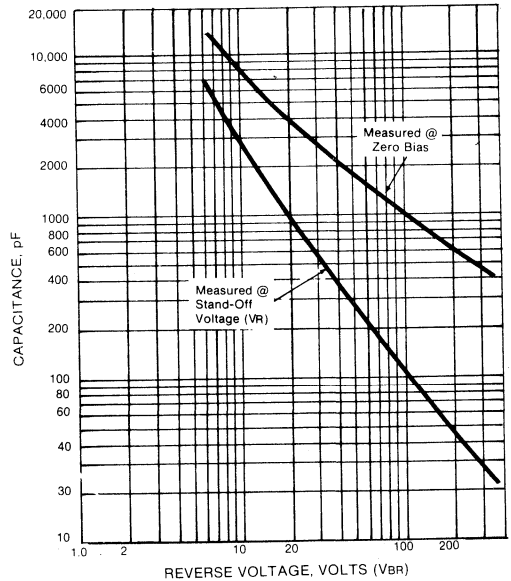

FIGURE 5 — STEADY STATE POWER DERATING

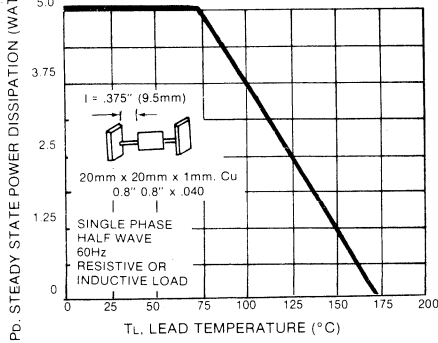
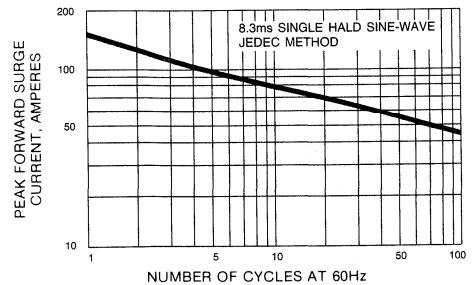

FIGURE 6 — MAXIMUM NON-REPETITIVE SURGE CURRENT



5KP SERIES

GLASS PASSIVATED JUNCTION TRANSIENT VOLTAGE SUPPRESSOR

VOLTAGE- 5.0 to 110 Volts
5000 Watt Peak Power 5.0 Watt Steady State

FEATURES

- ◆ Plastic package has Underwriters Laboratory Flammability Classification 94V-O
- ◆ Exceeds environmental standards MIL-STD-19500
- ◆ Glass passivated junction in Molded Plastic package
- ◆ 5000W surge capability at 1 ms
- ◆ Excellent clamping capability
- ◆ Low zener impedance
- ◆ Fast response time: typically less than 1.0 ps from 0 volts to BV min.
- ◆ Typical I_R less than $1 \mu A$ above 10V
- ◆ High temperature soldering guaranteed: 300°C/10 seconds/.375", (9.5mm) lead length/5lbs., (2.3 kg) tension

P600

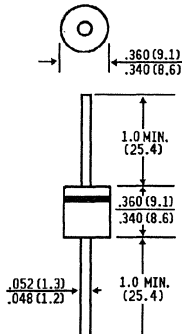

Dimensions in inches
and
(millimeters)

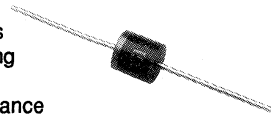

MECHANICAL DATA

Case : Molded plastic over glass passivated junction

Terminals: Axial leads, solderable per MIL-STD-202, Method 208

Polarity: Color band denoted cathode except Bipolar

Mounting Position: Any

Weight : 0.007 ounce, 2.1 gram

DEVICES FOR BIPOLAR APPLICATIONS

For Bidirectional use C or CA Suffix for types 5KP5.0 thru types 5KP110.

Electrical characteristics apply in both directions.

MAXIMUM RATINGS AND CHARACTERISTICS

Ratings at 25°C ambient temperature unless otherwise specified.

RATING	SYMBOL	VALUE	UNITS
Peak Power Dissipation at $T_A = 25^\circ C$, $T_p = 1ms$ (Note 1)	Ppk	Minimum 5000	Watts
Steady State Power Dissipation at $T_L = 75^\circ C$ Lead Lengths .375", (9.5mm) (Note 2)	PD	5.0	Watts
Peak Forward Surge Current, 8.3ms Single Half Sine-Wave Superimposed on Rated Load (JEDEC Method) (Note 3)	IFSM	400	Amps
Operating and Storage Temperature Range	$T_{J,TSTG}$	-55 to +175	°C

NOTES: 1. Non-repetitive current pulse, per Fig. 3 and derated above $T_A = 25^\circ C$ per Fig. 2.

2. Mounted on Copper Leaf area of 0.79 in² (20mm²).

3. 8.3ms single half sine-wave, duty cycle = 4 pulses per Minutes maximum



ELECTRICAL CHARACTERISTICS ($t_a = 25^\circ\text{C}$ unless otherwise noted)

Device	Breakdown Voltage V_{BR} Volts (Note 1)		@IT (mA)	Working Peak Reverse Voltage V_{RWM} (Volts)	Maximum Reverse Leakage at V_{RWM} $I_R(\mu\text{A})$	Maximum Reverse Current I_{RSM} (Note 2) (Amps)	Maximum Reverse Voltage at I_{RSM} (Clamping Voltage V_{RSM} (Volts))	Maximum Temperature Coefficient of V_{BR} (%C)
	MIN	MAX						
5KP5.0	6.40	7.30	50	5.0	2000	520	9.6	0.057
5KP5.0A	6.40	7.00	50	5.0	2000	543	9.2	0.057
5KP6.0	6.67	8.15	50	6.0	5000	439	11.4	0.061
5KP6.0A	6.67	7.37	50	6.0	5000	485	10.3	0.061
5KP6.5	7.22	8.82	50	6.5	2000	407	12.3	0.065
5KP6.5A	7.22	7.98	50	6.5	2000	447	11.2	0.065
5KP7.0	7.78	9.51	50	7.0	1000	378	13.3	0.068
5KP7.0A	7.78	8.60	50	7.0	1000	417	12.0	0.068
5KP7.5	8.33	10.2	5.0	7.5	250	350	14.3	0.073
5KP7.5A	8.33	9.21	5.0	7.5	250	388	12.9	0.073
5KP8.0	8.89	10.9	5.0	8.0	150	333	15.0	0.075
5KP8.0A	8.89	9.83	5.0	8.0	150	367	13.6	0.075
5KP8.5	9.44	11.5	5.0	8.5	50	314	15.9	0.078
5KP8.5A	9.44	10.4	5.0	8.5	50	347	14.4	0.078
5KP9.0	10.0	12.2	5.0	9.0	20	295	16.9	0.081
5KP9.0A	10.0	11.1	5.0	9.0	20	325	15.4	0.081
5KP10	11.1	13.6	5.0	10.0	15	266	18.8	0.084
5KP10A	11.1	12.3	5.0	10.0	15	294	17.0	0.084
5KP11	12.2	14.9	5.0	11.0	10	249	20.1	0.086
5KP11A	12.2	13.5	5.0	11.0	10	274	18.2	0.086
5KP12	13.3	16.3	5.0	12.0	10	227	22.0	0.088
5KP12A	13.3	14.7	5.0	12.0	10	251	19.9	0.088
5KP13	14.4	17.6	5.0	13.0	10	210	23.8	0.090
5KP13A	14.4	15.9	5.0	13.0	10	232	21.5	0.090
5KP14	15.6	19.1	5.0	14.0	10	194	25.8	0.092
5KP14A	15.6	17.2	5.0	14.0	10	215	23.2	0.092
5KP15	16.7	20.4	5.0	15.0	10	188	26.9	0.094
5KP15A	16.7	18.5	5.0	15.0	10	206	24.4	0.094
5KP16	17.8	21.8	5.0	16.0	10	176	28.8	0.096
5KP16A	17.8	19.7	5.0	16.0	10	176	26.0	0.096
5KP17	18.9	23.1	5.0	17.0	10	164	30.5	0.097
5KP17A	18.9	20.9	5.0	17.0	10	161	27.6	0.097
5KP18	20.0	24.4	5.0	18.0	10	155	32.2	0.098
5KP18A	20.0	22.1	5.0	18.0	10	172	29.2	0.098
5KP20	22.2	27.1	5.0	20.0	10	139	35.8	0.099
5KP20A	22.2	24.5	5.0	20.0	10	154	32.4	0.099
5KP22	24.4	29.8	5.0	22.0	10	127	39.4	0.100
5KP22A	24.4	26.9	5.0	22.0	10	141	35.5	0.100
5KP24	26.7	32.6	5.0	24.0	10	116	43.0	0.101
5KP24A	26.7	29.5	5.0	24.0	10	128	38.9	0.101
5KP26	28.9	35.3	5.0	26.0	10	107	46.6	0.101
5KP26A	28.9	31.9	5.0	26.0	10	119	42.1	0.101
5KP28	31.1	38.0	5.0	28.0	10	99	50.1	0.102
5KP28A	31.1	34.4	5.0	28.0	10	110	45.4	0.102
5KP30	33.3	40.7	5.0	30.0	10	93	53.5	0.103
5KP30A	33.3	36.8	5.0	30.0	10	103	48.4	0.103
5KP33	36.7	44.9	5.0	33.0	10	85	59.0	0.104
5KP33A	36.7	40.6	5.0	33.0	10	94	53.3	0.104
5KP36	40.0	48.9	5.0	36.0	10	78	64.3	0.104
5KP36A	40.0	44.2	5.0	36.0	10	85	58.1	0.104
5KP40	44.4	54.3	5.0	40.0	10	70	71.4	0.105

ELECTRICAL CHARACTERISTICS ($t_a = 25^\circ\text{C}$ unless otherwise noted)

Device	Breakdown Voltage V_{BR} Volts (Note 1)		@ I_T (mA)	Working Peak Reverse Voltage V_{RWM} (Volts)	Maximum Reverse Leakage at V_{RWM} I_R (μA)	Maximm Reverse Current I_{RSM} (Note 2) (Amps)	Maximum Reverse Voltage at I_{RSM} (Clamping Voltage V_{RSM} (Volts)	Maximum Temperature Coefficient of V_{BR} (% $^\circ\text{C}$)
	MIN	MAX						
5KP40A	44.4	49.1	5.0	40.0	10	78	64.5	0.105
5KP43	47.8	58.4	5.0	43.0	10	65	76.7	0.105
5KP43A	47.8	52.8	5.0	43.0	10	72	69.4	0.105
5KP45	50.0	61.1	5.0	45.0	10	62	80.3	0.106
5KP45A	50.0	55.3	5.0	45.0	10	69	72.7	0.106
5KP48	53.3	65.2	5.0	48.0	10	58	85.5	0.106
5KP48A	53.3	58.9	5.0	48.0	10	65	77.4	0.106
5KP51	56.7	69.3	5.0	51.0	10	55	91.1	0.107
5KP51A	56.7	62.7	5.0	51.0	10	61	82.4	0.107
5KP54	60.0	73.3	5.0	54.0	10	52	96.3	0.107
5KP54A	60.0	66.3	5.0	54.0	10	57	87.1	0.107
5KP58	64.4	78.7	5.0	58.0	10	49	103.0	0.107
5KP58A	64.4	71.2	5.0	58.0	10	53	93.6	0.107
5KP60	66.7	81.5	5.0	60.0	10	47	107.0	0.108
5KP60A	66.7	73.7	5.0	60.0	10	52	96.8	0.108
5KP64	71.1	96.9	5.0	64.0	10	44	114.0	0.108
5KP64A	71.1	78.6	5.0	64.0	10	49	103.0	0.108
5KP70	77.6	95.1	5.0	70.0	10	40	125.0	0.108
5KP70A	77.8	86.0	5.0	70.0	10	44	113.0	0.108
5KP75	83.3	102.0	5.0	75.0	10	37	134.0	0.108
5KP75A	83.3	92.1	5.0	75.0	10	41	121.0	0.108
5KP78	86.7	106.0	5.0	78.0	10	36	139.0	0.108
5KP78A	86.7	95.8	5.0	78.0	10	40	126.0	0.108
5KP85	94.9	115.0	5.0	85.0	10	33	151.0	0.108
5KP85A	94.4	104.0	5.0	85.0	10	36	137.0	0.110
5KP90	100	122.0	5.0	90.0	10	31	160.0	0.110
5KP90A	100	111.0	5.0	90.0	10	34	146.0	0.110
5KP100	111	136.0	5.0	100.0	10	28	179.0	0.110
5KP100A	111	123.0	5.0	100.0	10	31	162.0	0.110
5KP110	122	149.0	5.0	110.0	10	26	196.0	0.112
5KP110A	122	135.0	5.0	110.0	10	28	177.0	0.112

NOTES:

1. V_{BR} measured after I_T applied for 300 ms. I_T = Square Wave Pulse or equivalent.
2. Surge Current waveform per Figure 3 and Derate per Figure 2.
3. $V_f = 3.5$ Volts max $I_f = 100\text{A}$ for all types on 1/2 square or Equivalent Sine Wave.
PW = 8.3ms. Duty Cycle = 4 Pulse per Minute maximum.
4. For bipolar types with V_{BR} 10 Volts and under, the I_R limit is doubled.

RATINGS AND CHARACTERISTIC CURVES 5KP SERIES

FIGURE 1 — PULSE RATING CURVE

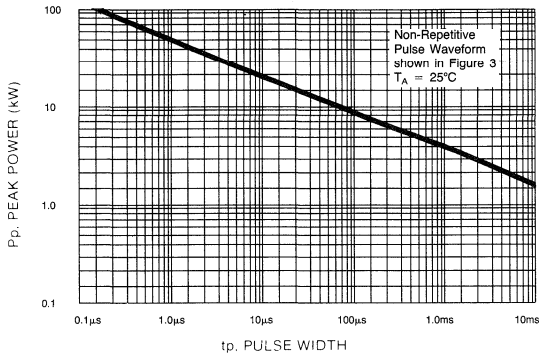

FIGURE 2 — PULSE DERATING CURVE

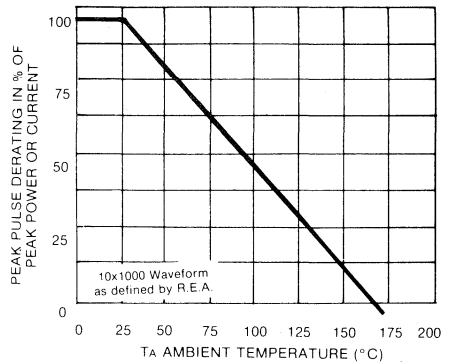

FIGURE 3 — PULSE WAVEFORM

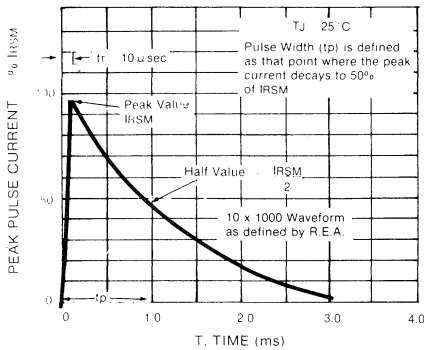

FIGURE 4 — TYPICAL JUNCTION CAPACITANCE

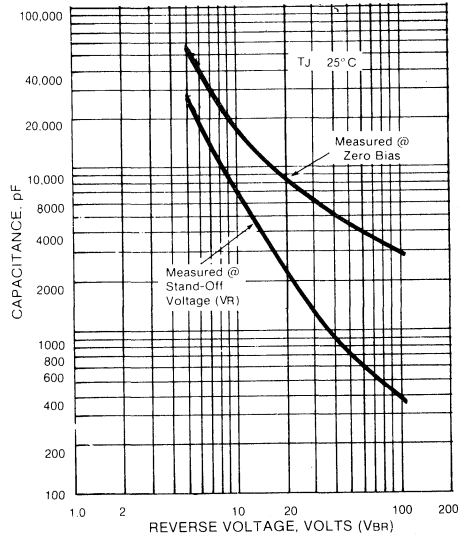

FIGURE 5 — STEADY STATE POWER DERATING

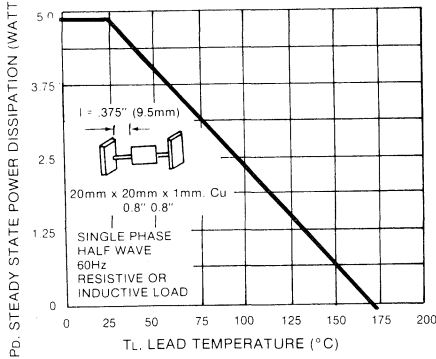
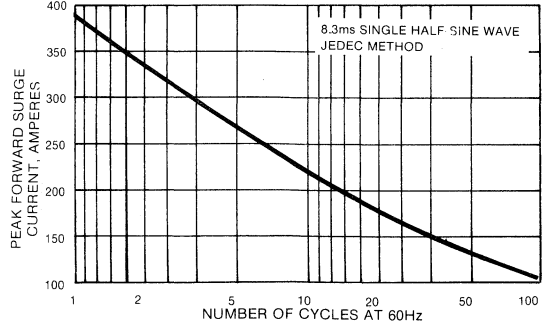
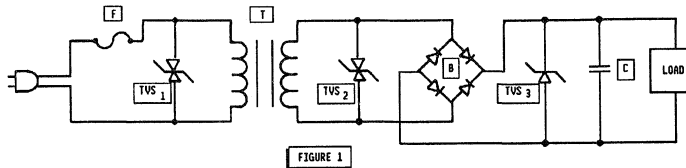

FIGURE 6 — MAXIMUM NON-REPETITIVE SURGE CURRENT



APPLICATIONS NOTE:

Transient Voltage Suppressors may be used at various points in a circuit to provide various degrees of protection. The following is a typical linear power supply with transient voltage suppressor units placed at different points. All provide protection of the load.



Transient Voltage Suppressor 1 provides maximum protection. However, the system will probably require replacement of the line fuse (F) since it provides a dominant portion of the series impedance when a surge is encountered.

Transient Voltage Suppressor 2 provides excellent protection of circuitry excluding the transformer (T). However, since the transformer is a large part of the series impedance, the chance of the line fuse opening during the surge condition is reduced.

Transient Voltage Suppressor 3 provides the load with complete protection. It uses a unidirectional Transient Voltage Suppressor, which is a cost advantage. The series impedance now includes the line fuse, transformer, and bridge rectifier (B) so failure of the line fuse is further reduced. If only Transient Voltage Suppressor 3 is in use, then the bridge rectifier is unprotected and would require a higher voltage and current rating to prevent failure by transients.

Any combination of these three, or any one of these applications, will prevent damage to the load. This would require varying trade-offs in power supply protection versus maintenance (time changing the fuse).

An additional method is to utilize the Transient Voltage Suppressor units as a controlled avalanche bridge. This reduces the parts count and incorporates the protection within the bridge rectifier.

The wattage ratings are available in 400 watts (P4KE, BZW04), 600 watts (P6KE), 1500 watts (1.5KE Series) and 5000 watts (5KP Series).

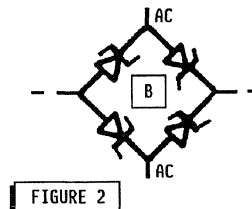

For voltage ranges not seen on specification sheet, please consult factory or the nearest sales office.

APPLICATION NOTES

**GENERAL
INSTRUMENT**

DESIGN GUIDELINES FOR SCHOTTKY RECTIFIERS

Known limitations of Schottky rectifiers -- including limited high temperature operation, high leakage and limited voltage range -- can be measured and controlled, allowing wide application on switch mode power supplies.

*Jon R. Schleisner
Senior Marketing Engineer
General Instrument Corp.,
Power Semiconductor Division
Hicksville, New York*

Schottky rectifiers have been used in the power supply industry for approximately 15 years. During this time, significant fiction as well as fact has been associated with this type of rectifier. The primary assets of Schottky devices are switching speeds approaching zero-time and very low forward voltage drop (V_f). This combination makes Schottky barrier rectifiers ideal for the output stages of switching power supplies. On the negative side, Schottky devices are also known for limited high-temperature operation, high leakage and limited voltage range (BVR). Though these limitations exist, they are quantifiable and controllable, allowing wide application of these devices in switch mode power supplies.

High leakage, when associated with standard P-N junction rectifiers, usually indicates "badness," implying poor reliability. In a Schottky device, leakage at high temperature (75 °C and greater) is often on the order to several milliamps, depending on chip size. In the case of Schottky barrier rectifiers, high-temperature leakage and forward voltage drop are controlled by two primary factors: the size of the chip's active area and the barrier height (ϕB).

Design of a Schottky rectifier can be viewed as a tradeoff. A high barrier height device exhibits low leakage at high temperature, however, the forward voltage drop increases. These parameters are also controlled by the die size and resistivity of the starting material. A larger die will lower the V_f but raise the leakage if all other parameters are held constant. The resistivity of the starting material must be chosen in a range where the breakdown voltage (BVR) is not degraded at the low end and the forward end of the resistivity range. Since a larger chip size is

obviously more expensive, this is not the primary method for controlling these parameters. Chip size is usually set to a dimension where the current density through the die is kept at a safe level.

Barrier Height (ϕB), A Factor

General Instrument produces two product lines of Schottky barrier rectifiers. One line is referred to as the "MBR" series, a high-temperature, low-leakage, relatively high V_f type of Schottky device with a high barrier height (ϕB). The second line is the "SBL" series, designed to operate at lower temperature (125°C or less); however, while leakage current is higher, forward voltage drop (V_f) is significantly lower and they are designed with

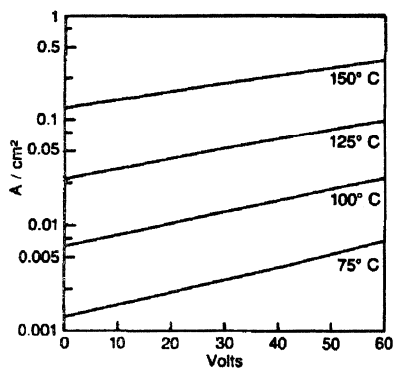

Figure 1
Voltage versus die area leakage barrier height = 0.71 volts

a low- ϕB barrier height. The low- ϕB -line SBL series uses a nichrome barrier metal with a barrier height of $\phi B = 0.64$ eV. The high- ϕB MBR series uses a nichrome-platinum barrier metal to achieve barrier height ($\phi B = 0.71$ eV). Both series are guard-ring protected against excessive transient voltages.

Both the low- and high-barrier-height Schottky devices are valuable in a variety

of applications. When the true operating temperature of the Schottky rectifier exceeds 125°C, the high-barrier-height series must be used to avoid thermal runaway. This occurs when excessive self-heating of the rectifier causes large leakage currents, resulting in additional self-heating. The process becomes a form of positive thermal feedback and may lead to damage in the rectifier or inappropriate functioning of the circuit utilizing the device.

Using a high-barrier-height (MBR) component prevents this anomaly, but sacrifices higher forward voltage. Operating the low barrier height (SBL) series at a junction temperature of 125° C or less prevents thermal runaway from occurring. If the junction temperature (Tj) in the application can be kept below 125° C, a decision on the use of a low- or high-barrier-height Schottky device must be made.

The following procedure has been developed to provide an analytical method of selecting the most efficient Schottky barrier device for a given application.

Calculating The Barrier Height (ϕB) of Schottky Rectifiers

Calculating the barrier height of a Schottky rectifier where ϕB is not given is a straightforward process. The following two equations will yield an excellent engineering approximation of the barrier height, ϕB :

$$\phi B = (-KT/q) \text{LN} (J / R^*T) \quad (1)$$

$$J_o = I_o / \text{ACTIVE AREA} (cm^2) \quad (2)$$

$\phi B = \text{barrier height} (eV)$

$K = \text{Boltsman's constant} = 8.62 \times 105 \text{ eV}/^\circ K$

$T = \text{ambient temperature in degrees Kelvin}$
 $J_o = \text{current density at zero volts}$
 $R^* = \text{Richardson's constant} = 112 \text{ /cm}^2 \text{ k}^2$
 $I_o = \text{forward current at zero volts}$

To solve Equation One, the current density J_o (Equation Two) must be found first:

$$J_o = I_o / \text{ACTIVE AREA} (cm^2) \quad (2)$$

General Instrument provides the active area of its Schottky die in its product literature. If a manufacturer does not supply this information, decapsulating the device under question and measuring it with a precision caliper can provide an approximation of the active Schottky area,

assuming 90% of the total chip area is active.

$$\text{Total die area} \times 0.9 = \text{active area} \quad (3)$$

The calculation of I_o is done graphically (Graph 1). A minimum of three low-current room-temperature forward voltage drop V_f measurements are needed. This data is graphed on semi-log paper (Graph 1) where the vertical axis (log scales) is the current and the horizontal axis (linear scale) is the measured V_f . When these points are graphed, the result should be a true straight line. If the graph curves downward (see the dotted line on the left side of Graph 1), it indicates that the lowest measurement current is being affected by the rectifier's room temperature leakage. In this case, the current level at which the V_f measurements are taken should be increased to "swamp" out the contribution of low level leakage on the measurement. If the current levels are raised excessively, the series resistance of the device in question will influence the measurements. This causes a downward curve as represented by the dotted line on the right side of **Graph 1**. Again, the results should yield a true straight line.

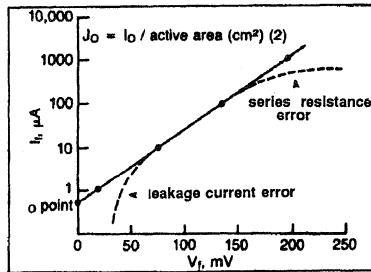

Graph 1

Calculation of J_o (current density at zero volts)

The point where the line intercepts the vertical axis is the current at zero volts (I_o). J_o is then calculated:

$$J_o = I_o / \text{ACTIVE AREA} (cm^2) \quad (2)$$

This result is then placed into the first equation:

$$\phi B = (-KT/q) \text{LN} (J_o / R^*T^2) \quad (1)$$

The results of the calculation are usually in the range of 0.6 eV to 0.8 eV. Results

well outside this range indicate either a defective rectifier, measurement, or calculation error.

Selecting Efficient Schottky Devices

Normalized graphs of the low (SBL) and high (MBR) barrier height processes are provided. The vertical axis on all graphs is in amperes per square centimeter (A/cm^2). The horizontal axis provides forward voltage drop for the low and high barrier parts. Two additional graphs have the horizontal axis labeled for reverse voltage (V_r) for both the low and high barrier series. The graphs for the low barrier (SBL) series parts have curves for operation at 75 °C, 100 °C and 125 °C.

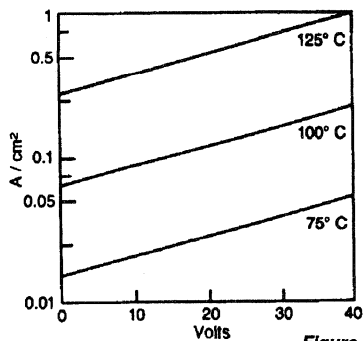

Figure 2
Voltage versus die area leakage barrier height = 0.64 volts

These curves may be used in two ways. If the die size, barrier height, temperature and forward current (I_f) are known, V_f can be graphically calculated. Using the leakage curves, and knowing the reverse voltage (V_r) to which the device will be subjected, it is possible to find the leakage current. Conversely, if the circuit parameters are set, the curves will provide the die size in A/cm^2 equations, making it possible to analytically select either a low- or high-barrier-height rectifier for maximum circuit efficiency. Most Schottky rectifiers are used in switch mode power supplies.

To select a Schottky rectifier that yields maximum efficiency, it is necessary to determine the "duty cycle equilibrium point," or the duty cycle point at which both a low- and high-barrier-height part will dissipate precisely the same amount of power:

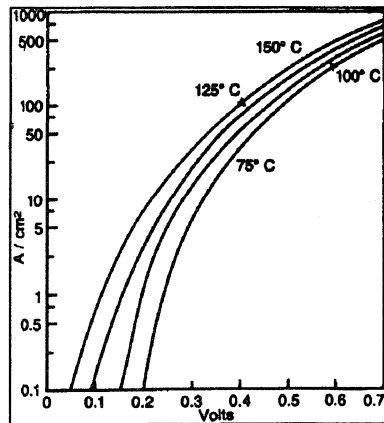

Figure 3
Die area current versus forward voltage drop barrier height = 0.71

$$D (P_{df\phi BL}) + (1-D)(P_{dr\phi BL}) = D (P_{dr\phi BH}) + (1-D)(P_{df\phi BH}) \quad (1)$$

$$P_{dt} = P_{df} + P_{dr} \quad (2)$$

$$P_{df} = I_f \times V_f \quad (3)$$

$$P_{dr} = I_r \times V_r \quad (4)$$

D = duty cycle forward conduction

$1-D$ = duty cycle reverse blocking

I_f = forward current

I_r = reverse current

P_{df} = power dissipation in forward

P_{dr} = power dissipation in reverse

P_{dt} = total power dissipation

V_f = forward voltage drop

V_r = reverse voltage

ϕBL = low barrier height

ϕBH = high barrier height

The following is an example of the use of this equation:

Given the need for a 30-volt Schottky capable of operating at 10 amperes, the choice is between a SBL1040 ($\phi_{BL} = 0.64$) or a MBR1045 ($\phi_{BH} = 0.71$). These two devices were chosen for convenience in this example because of their equal die size (0.0477cm^2 active area).

The equilibrium point must be calculated for 75°C, 100°C and 125°C. For demonstration purposes, only the 75°C equilibrium point will be calculated in detail; the other two points are calculated in the same manner. The reverse leakage (I_r) and forward voltage drop (V_f) are derived from Graphs 1 through 4 using the temperature, die size and ϕB given above.

For the low-barrier-height SBL1040:

$$P_{dr} = V_r \times I_r = \text{watts} \quad (4)$$

$$30 \text{ V} \times (1.9 \times 10^{-3} \text{ A}) = 0.057 \text{ W}$$

$$P_{dr} = I_f \times V_f = \text{watts} \quad (3) \quad (3)$$

$$10 \text{ A} \times 0.46 \text{ V} = 4.6 \text{ W}$$

For the high-barrier-height MBR1045:

$$P_{dr} = V_r \times I_r = \text{watts} \quad (4) \rightarrow 30$$

$$\text{V} \times (1.43 \times 10^{-4} \text{ A}) = 4.29 \times 10^{-3} \text{ W}$$

$$P_{df} = I_f \times V_f = \text{watts} \quad (3)$$

$$10 \text{ A} \times 0.565 \text{ V} = 5.65 \text{ W}$$

Solving for the equilibrium point at 75°C:

LOW BARRIER **HIGH BARRIER**

$$(D \times P_{dr\phi_{BL}}) + [(1-D) \times P_{dr\phi_{BL}}] =$$

$$(D \times P_{dr\phi_{BH}}) + [(1-D) \times P_{dr\phi_{BH}}]$$

$$(D \times 4.6 \text{ W}) + [(1-D) \times 0.057 \text{ W}] =$$

$$(D \times 5.65 \text{ W}) + [(1-D) \times 0.00429 \text{ W}]$$

$$0.05271 = 1.1027 D$$

$$D = 0.0478$$

$$D\% = 0.0478 \times 100$$

duty cycle equilibrium point, $D = 4.78\%$

Switching loss is assumed to be equal on both sides of the equation and thus is ignored. This procedure is then repeated for 100°C and 125°C. After calculating the equilibrium point for 100°C and 125°C, the results are:

TEMP	DUTY CYCLE EQUILIBRIUM POINT %
75°C	4.78%
100°C	15.93%
125°C	52.42%

The results of these calculations are graphed in Figure 5. To the left of the equilibrium curve, the high-barrier-height

MBR1045 is most efficient; to the right of the equilibrium curve, the low-barrier-height SBL1040 is more efficient. This is easy to understand because the high-bar-

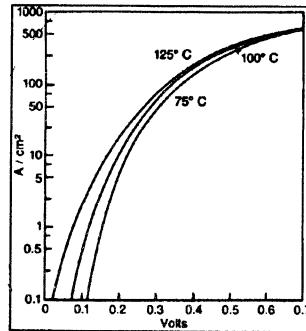

Figure 4
Die area current versus forward voltage drop barrier height = 0.64

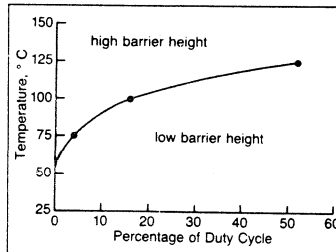

Figure 5
Duty cycle equilibrium point MBR1045 versus SBL1040

rier-height part exhibits lower reverse power loss and at a low duty cycle more time is spent in the reverse mode.

With the duty cycle higher than the equilibrium point, the part spends a larger percentage of time in the forward mode, and the low-barrier-height type part has a lower V_f and the forward power losses are reduced.

With knowledge of the application, including expected duty cycle and temperature, it is possible to choose the most efficient Schottky barrier rectifier, constructing a graph similar to Figure 1.

It is thus easy to graph the duty cycle versus temperature, as in Figure 5, and by knowing the application (expected duty cycle and temperature), make the intelligent choice of the most efficient Schottky rectifier for the application in question.

This analysis technique enables the design engineer to make an efficient and cost-effective choice of Schottky rectifier in duty-cycle-based systems. In addition, light has hopefully been shed on the difference in design philosophies between the low- and high- ϕB style of Schottky rectifiers.

SELECTING THE OPTIMUM VOLTAGE TRANSIENT SUPPRESSOR

Although the published data for several transient suppressors may appear similar enough to make the devices seem interchangeable, careful analysis can rule out nearly identical parts whose use could prove disastrous.

Jon R. Schleisner, Senior Marketing Engineer
General Instrument, Power Semiconductor
Division
Hicksville, New York

Transient voltage suppressors (TVS) are specialized zener diodes intended to clamp the voltage appearing across a line, thereby preventing transient spikes from damaging sensitive components. They accomplish this conducting when the voltage across the line exceeds the zener-avalanche rating. Because transient voltages can be quite high, suppressors must be able to handle large avalanche currents. This means that care must be taken in the construction of the package and assembly process to ensure that the suppressor can tolerate high energy levels for short periods.

Typical transient voltage suppressors carry peak ratings of 400, 600, 1500 or 5000 watts. These wattages translate to 0.55, 0.80, 2.10 or 7.00 joules of energy during a 1-millisecond period. Avalanche ratings generally range from a few volts to several hundred volts. Key operating parameters include:

◆ **Breakdown voltage (V_{BR})**, the voltage at which a given device breaks down in its avalanche mode. This voltage is usually characterized at a test current (I_T) of 1 milliamp and is often specified as a range with minimum ($V_{BR \text{ min}}$) and maximum ($V_{BR \text{ max}}$) voltages listed.

◆ **Working peak reverse voltage (V_{RWM})**, the voltage at which the device's leakage current is measured. This voltage is always at least 10 percent lower than the minimum breakdown voltage. Suppressors with a breakdown-voltage rating of less than 10 volts can exhibit leakage currents as high as 1 milliamp, but suppressors with higher breakdown ratings typically exhibit leakage currents of 5 microamps or less.

◆ **Maximum reverse surge current (I_{RSM})**, the maximum current that the suppressor is guaranteed to withstand without incurring damage. This parameter is usually characterized with a 1-millisecond exponential waveform.

◆ **Maximum reverse voltage (V_{RSM})**, also called the maximum clamping voltage, the maximum voltage that can appear across the suppressor when the maximum rated surge current is flowing through it.

◆ **Maximum breakdown-voltage temperature coefficient ($\%V_{BR} / ^\circ C$)**, the maximum allowable change in the breakdown voltage as a function of the temperature.

Design Criteria

The best way to demonstrate the selection process is through a hypothetical example. In this example, the device to be protected is an integrated circuit, IC_X, which is designed to operate on a nominal rail voltage of 15 volts, and which has an absolute maximum voltage rating of 22 volts. The first step in the selection process is to determine the energy (joules) or power (watts) contained in the surge against which the device is to be protected, and the duration of that surge.

Transients are by definition nonrepetitive, with energy levels that are difficult to ascertain. Moreover, they generally result from an unexpected failure elsewhere in the system or from natural phenomenon such as lightning. Because of this, determining energy content and duration of the surge is the most difficult step in the transient-suppressor selection process.

Some surges, however, are predictable. The surge produced by a solenoid driver is a good example. If the inductance of the coil is known and the load on the solenoid is defined, it is possible to calculate or measure the duration and magnitude of the surge. Whenever possible, a "hands

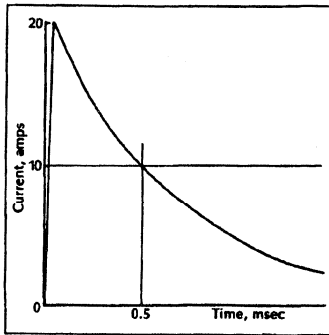

Figure 1

Waveform of an exponential-decay transient pulse with a peak current and a 0.5-millisecond pulse width at the half-peak-current point

on" measurement of the worst-case transient condition should be made. For the sake of discussion, assume that the transient being presented to IC_x has a peak current of 20 amps with a classic exponential decay, as shown in Figure 1, and a duration of 0.5 milliseconds, measured at 50 percent of the peak current.

With this data in hand, the next step is to examine manufacturer's data sheets to find a transient suppressor able to handle the anticipated surge. The breakdown voltage and maximum reverse surge current ratings published in the data sheets are key selection criteria. Since IC_x has a nominal 15-volt operating voltage, the minimum breakdown voltage must be greater than 15 volts. However, since it carries a 22-volt absolute maximum voltage, the suppressor's maximum breakdown voltage must be less than 22 volts. The foregoing assumes a relatively stable ambient temperature, such as that usually experienced in an office environment. If the product in which IC_x is used is expected to see wider temperature

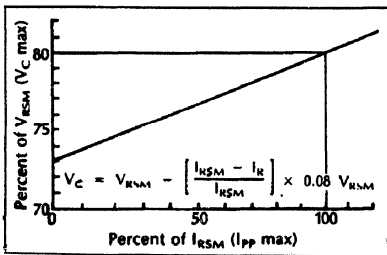

Figure 2

The clamping characteristic of a typical transient suppressor

fluctuations, the minimum breakdown voltage would have to be based on the lowest expected temperature. The resulting voltage would be determined by multiplying the difference between the expected temperature and room temperature by the temperature coefficient.

Waveshape	Equation	K Factor
	$I_{pk} e^{-0.7144t}$	1.4
	I_{pk}	1.0
	$I_{pk} (t/\tau)$	0.5
	$I_{pk} \sin(\pi t) e^{-t/\tau}$	0.86
	$I_{pk} \sin((\pi/\tau) t)$	0.637

$$\text{Energy} = \int_0^{\tau} V_c(t) I(t) \Delta t = K V_c I$$

Figure 3

The energy contained in a transient pulse depends on its wave shape

With the minimum and maximum permissible breakdown voltages in hand, examine the clamping-voltage ratings published in the manufacturer's data sheets to identify suppressors falling within the required range. It is possible that there is no device that falls well within the upper and lower limits. If the device with the closest voltage rating falls about the upper voltage limit, a very close examination of its parameters must be made. Most reputable semiconductor manufacturers apply a one-percent guardband around voltage ratings as a safety margin. In this example, the guardband raises the absolute maximum rail voltage from 22 volts to 22.22 volts.

This small increase may not seem like much, but can make the difference in selecting a transient suppressor.

Selecting the Best Transient Suppressor

Consider a situation in which the only suppressor that comes close to meeting the protection need of IC carries a maximum clamping-voltage rating of 22.5 volts. The actual voltage at which the suppressor will clamp depends on the actual current flowing through it, as shown in Figure 2, and can be predicted using the following equation:

$$V_{RSM} - [(I_{RSM} - I_R) / (I_{RSM})] \times (0.08)V = V_C$$

For the sake of discussion, consider the General Instrument type P6KE16A transient suppressor, which carries a 22.5-volt maximum clamping-voltage rating.

$$22.5 - [(27 - 20) / 27] \times 0.08 (22.5) = 22.03 \text{ volts}$$

Although the resulting clamping voltage is still greater than the 22-volt absolute maximum voltage rating carried by IC x, it is well within the 22.22-volt rating provided by the one-percent guardband. Thus, although carrying a maximum clamping-voltage rating 0.5 volt higher than the maximum voltage rating carried by ICx, this suppressor can be safely used in this application.

The same, however, cannot be said of all 22.5-volt suppressors. Another device in the same family, the P4KE16A, has slightly different current ratings and yields considerably different results:

$$22.5 - [(19 - 20) / 19] \times 0.08 (22.5) = 22.59 \text{ volts}$$

Clearly, with a 22.59-volt clamping voltage, this device cannot be used because it exceeds the maximum clamping-voltage rating plus guardband of ICx.

The next step in the selection process is to verify the transient suppressor's power rating. There are two approaches that can be taken:

1. Since the waveform of the transient is a classic exponential decay with a 0.5-millisecond duration at the half-peak current point, a graphic plot of peak power versus time can be used. This graph is often published in manufacturer's data sheets and if it is available for the device under consideration, one need only compare the anticipated current against the current shown in the graph. Using the peak-power versus time graph published for the P6KE series suppressors, it can be seen that with a 0.5-millisecond time-constant decay, a P6KE device can handle a peak power of 792 watts.

Using Ohm's law and a 22-volt clamping voltage, this translates to:

$$I = P/V = 792/22 = 36 \text{ amps}$$

Since the anticipated peak reverse current with a 0.5-millisecond time constant is 20 amps, it is clear that a P6KE device can easily withstand the anticipated peak power of the surge.

2. Calculate the energy in joules contained in the transient and compare it to the maximum energy rating of the transient suppressor. The energy in the transient, of course, depends on its wave shape, as shown in Figure 3. The amount of energy a given transient suppressor can handle, on the other hand, depends on its energy rating and the duration of the pulse, as shown in Figure 4. In this example, the waveform has an exponential shape with a 20-amp peak current and a 0.5-millisecond half-peak-power point. Using these data, the energy calculations are as follows:

$$E = V_C(t) \times I(t) \times A(t) - K V_C \times I \times \tau$$

where, in this example,

$$V_C = 2V$$

$$I = 20A$$

$$\tau = 0.5 \text{ msec}$$

$$K = 1.4 \text{ (from Figure 3)}$$

$$\text{Thus } E = 1.4 \times 22 \times 20 \times (0.5 \times 10^{-3}) = 0.308J$$

The maximum single-pulse energy rating for a P6KE series is 0.83 joules for a pulse of 1 millisecond duration. Referring to Equation 4, the energy rating for a 0.5-millisecond pulse becomes $0.7 \times 0.83 \text{ J}$, or 0.581 joules. Clearly, then, a P6KE device can easily handle the 0.308-joule energy contained in the anticipated transient pulse.

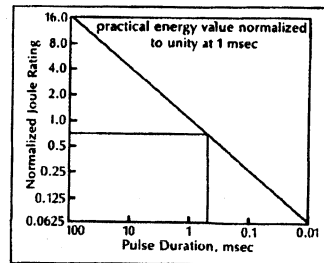

Figure 4
Energy-handling capacity of a transient voltage suppressor as a function of the transient's duration

Conclusion

The above example assumes a non-repetitive transient, or, if repetitive, each pulse is separated from the others by an interval of least 20 seconds. Under these conditions, however, the procedures outlined provide a straightforward and reliable method of selecting the best transient voltage suppressor for a given application.

SUPERECTIFIER DESIGN BRINGS NEW LEVEL OF RELIABILITY TO SURFACE MOUNT COMPONENTS

By: Joseph M. Beck, Senior Applications Engineer

Surface Mount technology is here to stay. After years of plodding through cautious experimentation, many manufacturers now have fully automated production lines in place. These production lines place circuit components at speeds that until recently would have been unthinkable. Finally being realized are the benefits of what was once considered a "Voo Doo" manufacturing technology.

Component manufacturers have learned a great deal over the past several years as well. Initially most surface mount components were nothing more than retrofit, lead formed versions of their conventional leaded, through-hole counterparts. For most manufacturers this was the quickest and least costly method of "developing" a line of surface mountable components.

It was soon discovered, however, that this approach to component assembly would be unacceptable. Surface mount technology placed new demands upon circuit components. Electrically, the same power was being required from smaller and smaller packages. Package geometries and dimensions became critical in relation to pick and place equipment and circuit board mounting. In addition, the construction of these devices needed to be such that they would suffer no ill effects when subjected to the rigors of the new assembly environment that surface mount technology presented. Encountered in this environment was extremely high-speed pick and place equipment, component adhesive attachment, immersion in molten solder and rapid temperature changes associated with reflow soldering processes. All this meant that component manufac-

turers would have to re-think their approach to device fabrication. Yes, components needed to be smaller; but they also needed to be more reliable.

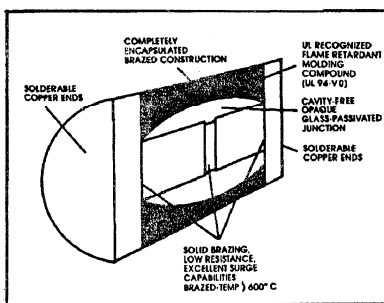

Figure 1 SUPERECTIFIER construction

At General Instrument, the development of new surface mount components is not something that is taken lightly. It is realized that in order to produce a truly reliable surface mount product one must first consider all relevant aspects of the technology. Only when this process has been completed can a product be developed which is surface

mountable, and inherently reliable.

Surface Mount Superectifier®

General Instrument manufactures surface mount rectifiers in the popular MELF (metalized electro face) package style. These devices, denoted as SUPERECTIFIERS, are available with a wide variety of electrical characteristics. The main difference, however, between these rectifiers and other MELF style devices lies in the area of device construction. Figure 1 shows the unique construction employed in the manufacture of the SUPERECTIFIER.

The construction of the SUPERECTIFIER does not internally utilize any soft solders. All interconnects are accomplished by the use of a high temperature brazing process (600°C). Hence, any chances of solder void occurrence or internal solder reflow during circuit board processing are eliminated. In addition, the silicon rectifier junction is completely encapsulated by a cavity-free glass. This glass encapsulation ensures that the rectifier junction is hermetically isolated from humidity and other harmful environmental intrusions.

The resultant sub-assembly could be considered to be a fully functional surface

mount rectifier. In fact, many component manufacturers offer MELF devices which have this appearance; namely, an oblong glass bead with two protruding metal end terminations. However, in order that the device have a uniform shape, the General Instrument sub-assembly is over molded with epoxy. The result is a smooth, perfectly cylindrical package.

Two Sizes

Two different size SUPERECTIFIER MELF packages are available. General Instrument designation GL34 and GL41 are for 0.5 ampere and 1.0 ampere rectifier types, respectively. JEDEC mechanical specifications DO-213AA and DO213AB detail the dimensions of the GL34 and GL41, respectively. Figure 2 gives these package dimensions.

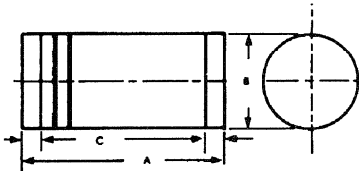

DIM.	GL34 DO-213AA		GL41 DO-213AB	
	MIN	MAX	MIN	MAX
A	.130	.146	.189	.205
B	.063	.067	.094	.105
C	.016	.022	.016	.022

NOTE: ALL DIMENSIONS IN INCHES

Figure 2

Dimensional outline

MANUFACTURING CONSIDERATIONS

Pick and Place--Surface mount SUPERECTIFIERS are supplied on tape and reel in accordance with JEDEC standard RS-481A. Removal of the devices from the embossed carrier tape is easily accomplished by all vacuum pick-up mechanisms which utilize a compliant tip. The compliant tip will form a tight seal around the cylindrical MELF design once contact with the device has been made. This is not always the case, however, when MELF devices with a non-uniform package outline are used. Figure 3 shows two such MELF outlines. Figure 3A is a device with a concave package outline. This type of package is difficult to consistently remove from the carrier tape as the exact position of pick-up on the component body is critical. Figure 3B is that of the most common form of MELF pack-

aging. This type of construction utilizes a non-transparent glass body which is

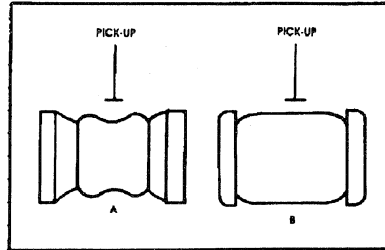

Figure 3

Non-uniform MELF outlines

often characterized by pitting and surface irregularities. The irregularities make it difficult for a vacuum pick-up to form a tight seal around the device body. The result is that components are often dropped onto the production room floor instead of being placed on the targeted circuit board. General Instrument solves these problems with a smooth surface and perfectly cylindrical package outline.

Bonding Pads --The geometries and dimensions of bonding pads are critical to the proper mounting, soldering and overall performance of all surface mount components. Figure 4 gives the recommended pad layouts for GL34 and GL41 MELF outlines. Use of these pad layouts will be primary assistance in the following three areas:

- ◆ Surface mount technology by nature dictates that smaller component packages dissipate the same power as their larger through-hole counterparts. Hence, adequate bonding pad land area is required in order to aid the component package in the dissipation of this power. The recommended pad layouts provide the needed land area for GL34 and GL41 devices to operate safely at their maximum ratings.
- ◆ Component adhesive attachment allows the package to shift slightly from its original placement position prior to adhesive curing. In addition, most adhesives tend to spread during the curing process which also may allow package misalignment. The geometry of the recommended pad layouts will tend to minimize such movements. This assumes, of course, that the package was originally positioned correctly.
- ◆ During reflow soldering, solder surface tension can have a significant effect on the movement and final position of com-

ponents in relation to their bonding pads. The recommended pad layouts will actually make use of the solder surface tensions to bring MELF devices into alignment with the two bonding pad land areas. This means that MELF devices which are initially placed in slight misalignment on their bonding pads will reposition themselves during solder reflow until a position of alignment is reached.

Soldering—Surface mount SUPERECTIFIERS are capable of withstanding all present forms of wave and reflow soldering. The following guidelines should be followed, however, in order to ensure overall package integrity:

- ◆ GL34--Maximum temperature at device and terminations not to exceed 400°C for 5 seconds. Complete device submersible temperature not to exceed 260°C for 10 seconds in solder bath.
- ◆ GL41--Maximum temperature at device end terminations not to exceed 450°C for 5 seconds. Complete device submersible temperature not to exceed 265°C for 10 seconds in solder bath.

General Instrument's surface mount SUPERECTIFIERS combine superb electrical performance with unmatched levels of reliability. The construction of the SUPERECTIFIER virtually eliminates all problems associated with high-speed pick and place of MELF components. In addition, SUPERECTIFIER construction ensures that performance and reliability are never compromised when the device is subjected to the demands of surface mount assembly techniques or when other seemingly harmful environments are encountered. Quite simply, no other surface mount rectifier comes close to offering all the advantages of the SUPERECTIFIER MELF.

All surface mount components are small and save space. However, performance and reliability should never be considered necessary trade-offs in order to utilize surface mount technology. Use of General Instrument surface mount SUPERECTIFIERS requires no such sacrifices; no trade-offs.

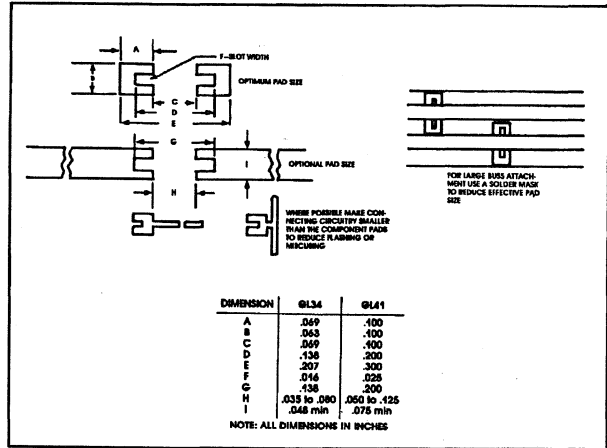

Figure 4

Recommended pad layout

SURFACE MOUNT SUPERECTIFIER AVAILABILITY:				
PART NUMBER	CURRENT(A)	VOLTAGE(V)	TRR(ns)	PACKAGE
GENERAL PURPOSE				
GL34A-M	0.5	50-1000	—	GL34
1N6478-B4	1.0	50-1000	—	GL41
GL41A-M	1.0	50-1000	—	GL41
FAST RECOVERY				
RGL34A-M	0.5	50-1000	150-500	GL34
RGL41A-M	1.0	50-1000	150-500	GL41
ULTRA FAST RECOVERY				
EGL41A-G	1.0	50-400	50	GL41
EGL34A-G	0.5	50-400	50	GL34

Protection of Power Supply and Data Lines Via Thyristor Surge Suppressor and TVS Devices

by Jon Schleisner

The Power Semiconductor Division of General Instrument (PSD), a mainstay in the arena of axial rectifiers, Schottky diodes, TVS, and surface mount technology, has extended its product line. PSD has entered the exciting and growing market of solid state "crowbar" type protection products.

Protection of power supply and data lines against transients is an art still in evolution. The advent of microprocessor-driven telephone systems based on sensitive electronics (instead of charcoal compressive microphones) has changed the criteria for protection. MOVs, gas tubes, and carbon blocks have been the staple components for protection schemes for decades.

These older protection devices have several advantages and disadvantages versus their solid state counterparts. The common advantages are low cost and the ability to absorb tremendous amounts of energy. The disadvantages include slow turn-on times, lack of totally controllable breakover (gas tube) and avalanche (MOV, carbon block) voltages, and an inherent wear-out mechanism (use them and you lose them).

The advantages of the General Instrument's TVS and Thyristor Surge Suppressor devices are speed of response (pico- and nanoseconds), control of avalanche (Zener) voltage, and breakover voltage. Solid state protectors do not shift in parametric value unless stressed beyond their rated limits and driven to destruction. The disadvantage of solid state protection are generally lower power handling capacity and higher costs.

The cost factor is rendered moot if the slow protection device (MOV or gas tube) acts too slowly to protect the system to which it is dedicated.

The power limitations can be overcome, to a great degree, with some imaginative engineering. Thyristor Surge Suppressors and TVS devices are specified differently. Table 1 lists all the pertinent

TVS and Thyristor Surge Suppressor device parameters for comparison. While both devices are used for transient protection, their electrical behavior is quite different.

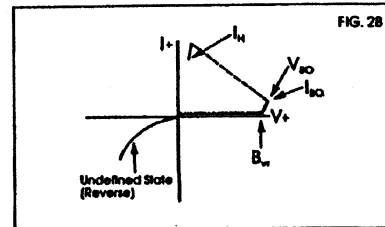
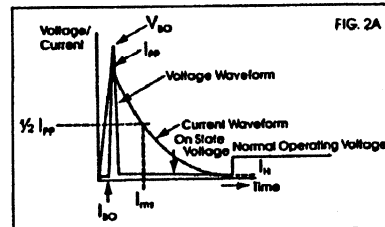
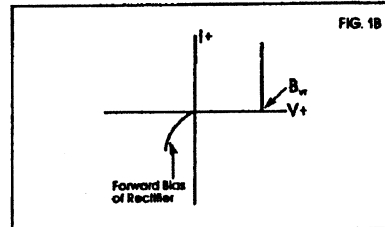
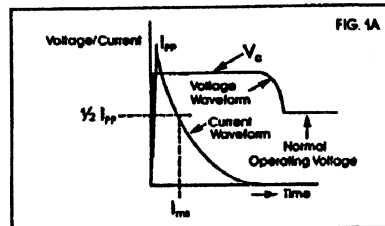

TVS B_{VR} - The voltage at which the part goes into reverse breakdown at a specified test current, usually 1 or 10 milliamps.

Thyristor Surge Suppressor V_{BR} - The voltage at which the Thyristor Surge Suppressor device begins to conduct current, equivalent to the TVS BVR.

Thyristor Surge Suppressor V_{BO} - The voltage at which, when reaching the specified I_{BO} , causes the device to "fire" or "fold back" in the low-voltage forward mode.

Thyristor Surge Suppressor I_{BO} - The required current at V_{BO} that causes the devices to "break over or fold back".

TVS V_{RSM} - The maximum specified voltage at I_{pp} , the TVS max clamping voltage.

TVS I_{RSM} - The max rated current to test the VC parameter.

Thyristor Surge Suppressor V_t - The voltage drop across the device at the specified I_t , after the device folds back.

I_t - The specified current at which V_t is tested.

I_R - This is a leakage spec with V_R set to less than BVR or VBR on TVS or Thyristor Surge Suppressor devices.

Thyristor Surge Suppressor I_H - This is a spec. that is unique to "Thyristor Surge Suppressor" technology. After the device has been "fired," when the current starts to decay and passes below a critical value (usually several hundred milliamps), the device turns off and resumes its normal high impedance state

There is no TVS equivalent to I_H (holding current). This function is important; it places certain critical limitations on application of the Thyristor Surge Suppressor device. Consider a power supply output with a 1-amp current limit. If this line is protected with a Thyristor Surge Suppressor device with an $I_H=500mA$, problems will arise. If the is fired, it will never shut off. The available current from the power supply is greater than I_H , hence the part will stay turned on until power is momentarily removed. This classic condition requires attention whenever designing in a Thyristor Surge Suppressor device in a protection system.

This aspect of Thyristor Surge Suppressor device performance makes it ideal for protection of data lines from lightning and other true transient voltage conditions. Typical data lines have current limiting set rather low. The telephone system in North America has a current limit of 250mA, so maintaining $I_H=250mA$ will ensure device turn-off after the passage of the transient.

Fig. 1 & 2 highlight differences in TVS and Thyristor Surge Suppressor device performance.

The following figures provide an explanation of circuit applications:

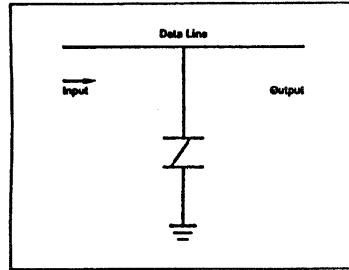

FIGURE 1.

The simplest and most direct application of a Thyristor Surge Suppressor device across a medium to slow data line. If a positive transient strike exceeds V_{BO} with sufficient I_{BO} , the Thyristor Surge Suppressor device will fire, absorbing the transient.

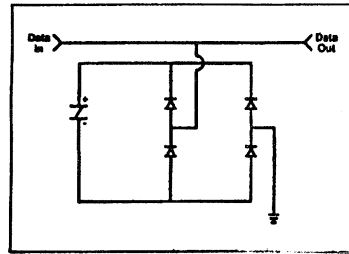

Figure 2

The same approach as Figure 1 with the addition of steering diodes to absorb bidirectional transients. Most transients are bidirectional in nature.

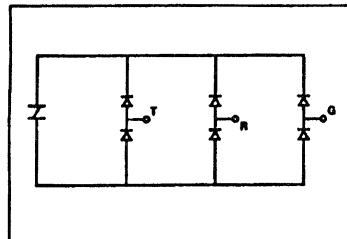

Figure 3

This is a further extension of Figure 2. With the terminals marked T (Tip), R (Ring), and G (Ground), this becomes the classic telephone line protection scheme.

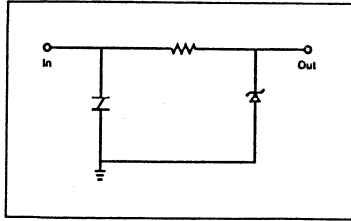

Figure 4

This is data line protection where the turn on transient approaching VBO (225 -260V) cannot be tolerated. The resistor limits the current through the TVS to $VBO - VC/R$, the duration of this pulse is typically less than 1 usec, so a small TVS can be used.

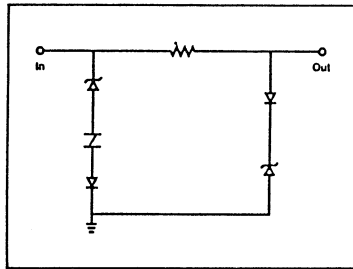

Figure 5

Similar to Figure 4, but designed to have reduced parasitic capacitance across the data line.

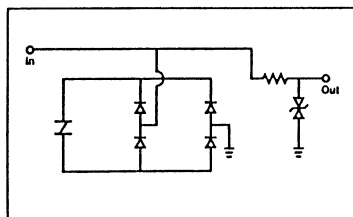

Figure 6

This circuit is a bidirectional version of Figure 4 with the low capacitance benefits of Figure 5.

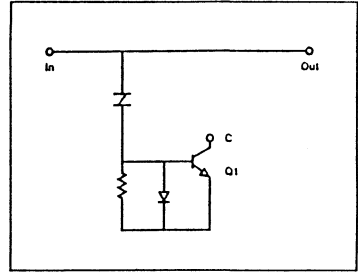

Figure 7

This is a power supply protection circuit. The open collector of Q1 is connected to the power source at the input and should be used to shut off the power supply output for a few milliseconds. This permits the current through the Thyristor Surge Suppressor device to fall below I_H before restart begins.

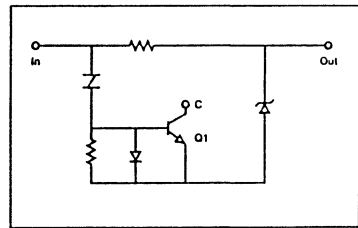

Figure 8

This circuit is equivalent to Figure 7 with the addition of TVS clamp at the output. This prevents VBO from appearing at the protection circuit's output.

General Instrument's Power Semiconductor Division will support your design efforts and assist in applying these new solid state protection devices. More protection performance for your dollar—that is our goal.

Using Rectifiers In Voltage Multiplier Circuits

By Joseph M. Beck
Sr. Applications Engineer

Systems designs frequently call for a high voltage, low current power source that needs only minimal regulation. A few familiar examples are CRT circuits, electrostatic copiers, and photoflash applications. Required voltages typically range from 10 to 30KV and the current demand rarely exceeds 5 milliamperes.

When your design requires this type of power source, you may want to consider a voltage multiplier circuit. They are inexpensive, easy to design, versatile, and can provide virtually any output voltage that is an odd or even multiple of the input voltage.

This article explores the basic operation of multiplier circuits and discusses guidelines for electronic component selection. Since General Instrument Corporation is the industry's leading manufacturer of rectifier products, we will place special emphasis on selecting rectifier diodes for multiplier circuits.

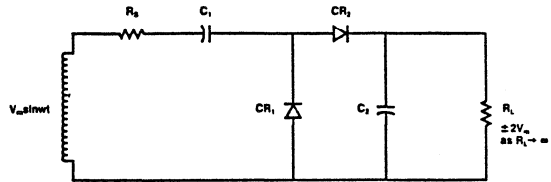

Figure 1A

Basic multiplier circuits. Half-wave Voltage Doubler

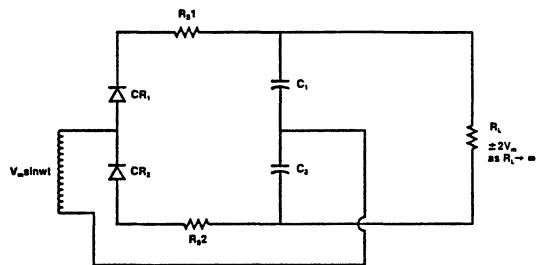

Figure 1B

Basic multiplier circuits. Full-wave Voltage Doubler

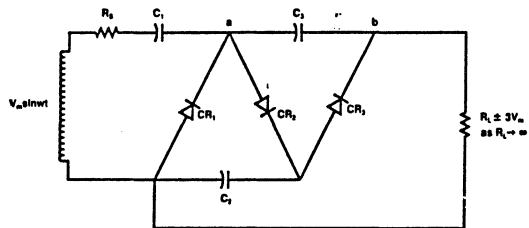

Figure 1C

Basic multiplier circuits. Half-wave Voltage Tripler

BASIC OPERATING PRINCIPLES

Most voltage multiplier circuits, regardless of their topology, consist chiefly of rectifiers and capacitors. Figure 1 shows three basic multiplier circuits.

The operating principle of all three circuits is essentially the same. Capacitors connected in series are charged and discharged on alternate half-cycles of the supply voltage. Rectifiers and additional capacitors are used to force equal voltage increments across each of these series capacitors. The multiplier circuit's output voltage is simply the sum of these series capacitor voltages.

A wide variety of alternating signal inputs are used with multiplier circuits. The most popular are sine and square wave inputs. For simplicity, this discussion will be limited to sine wave inputs; the calculations become somewhat more involved with asymmetrical signals.

Voltage Doublers - Figure 1A shows a half-wave voltage doubler circuit. It functions as follows. On the negative half-cycle of the input voltage, capacitor C₁ charges, through rectifier CR₁, to a voltage of V_m. On the positive half-cycle, the input voltage, in series with the voltage of C₁ (V_{c1}=V_m), charges capacitor C₂

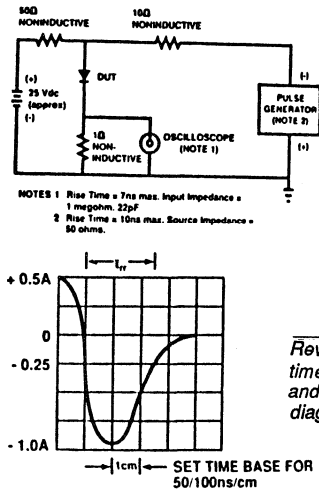

Figure 2
Reverse recovery time characteristic and test circuit diagram

through rectifier CR2 to the desired output voltage of $2V_m$. Capacitor C1, which aids in the charging of capacitor C2, sees alternating current ("AC Cap") while C2 sees only direct current ("DC cap"). In this circuit, the output voltage and the input signal have the same ripple frequency.

The same operating principle extends to the full-wave voltage doubler circuit of figure 1B. On the negative half-cycle of the input voltage, capacitor C2 is charged through rectifier CR2 to a voltage of V_m . On the positive half-cycle, capacitor C1 is also charged to a voltage of V_m , through rectifier CR1. The series voltages of capacitors C1 and C2 ($V_{c1} = V_{c2} = V_m$) yield the desired output voltage: $2V_m$. In this case, capacitors C1 and C2 are "DC capacitors"; they see no alternating current. The output ripple frequency of the full-wave doubler is twice that of the input signal.

Voltage Tripler - Higher output voltages are possible through the use of a half-wave voltage tripler circuit, shown in figure 1C. This circuit operates as follows. On the negative half-cycle of the input voltage, capacitor C1 charges through rectifier CR1 to a voltage of V_m . On the positive half-cycle, the input voltage, in series with the stored voltage on C1 ($V_{c1} = V_m$), charges capacitor C2 through rectifier CR2 to a voltage of $2V_m$. On the next negative half-cycle, the charge on C1 is replenished. At the same time, the input voltage, in series with the stored voltage on C2 ($V_{c2} = 2V_m$), charges capacitor C3 through CR3 to a voltage of $2V_m$ ($V_{c3} = V_b - V_a = (V_m + V_{c2}) - V_{c1} = 2V_m$). V_{c1} and V_{c3} , in series, provide the output voltage of $3V_m$. In this case, the output ripple frequency is equal to that of the input signal.

Although half-wave and full-wave multiplier circuits can provide equivalent output voltages, there are some fundamental differences that should be considered. First, the full-wave circuit has the advantage of higher output ripple frequency (twice that of the half-wave circuit). In addition, the full-wave circuit provides better voltage regulation than the half-wave circuit, since the latter relies upon one capacitor (C1 in figure 1A) to provide the charging energy to a single DC load capacitor (C2 in figure 1A). The full-wave circuit, however, requires that the secondary side of the transformer be capable of withstanding high voltages (approximately 1/2 of the output voltage). For this reason, the half-wave multiplier is usually the preferred circuit when high voltage outputs ($V_o = \text{kilovolts}$) are required.

DESIGN GUIDELINES

Capacitor selection - The size of capacitors used in multiplier circuits is directly proportional to the frequency of the input signal. Capacitors used in off-line, 60Hz applications are usually in the range of 1.0 to 20 μ F while those used in higher frequency applications, say 10KHz, are typically in the range of .02 to .06 μ F. In practice, it is usually easier, and less costly, to use the same large capacitance value for all capacitors, both "AC" and "DC" type. The overall capacitive reactance of the circuit must be considered, however, to determine the largest permissible value.

The voltage rating of capacitors is determined solely by the type of multiplier circuit. In the half-wave doubler circuit of figure 1A, C1 must be capable of withstanding a maximum voltage of V_m , while C2 must withstand a voltage of $2V_m$. In the full-wave doubler circuit of figure 1B, both C1 and C2 must withstand voltages of V_m . The half-wave voltage tripler of figure 1C requires C1 to withstand a voltage of V_m , and both C2 and C3 to withstand voltages of $2V_m$. A good rule of thumb is to select capacitors whose voltage rating is approximately twice that of the actual peak applied voltage. For example, a capacitor which will see a peak voltage of $2V_m$ should have a voltage rating of approximately $4V_m$.

Rectifier Diode Selection

Several basic device parameters should be considered:

Repetitive Peak Reverse Voltage (V_{rrm}) - Repetitive peak reverse voltage is the maximum allowable instantaneous value of reverse voltage across the rectifier diode. Applied reverse voltages below this maximum value will produce only negligible leakage cur-

rents through the device. Voltages in excess of this maximum value, however, can cause circuit malfunction --- and even permanent component damage --- because significant reverse currents will flow through the device. For example, General Instrument's GP02-40 rectifier diode has a peak reverse voltage rating (V_{rrm}) of 4,000 volts, maximum. Applied reverse voltages of 4KV or less will produce a maximum reverse leakage current, I_R , of 5 microamperes through the device when operated at room temperature (25 °C). In most cases, this leakage current is considered negligible, and the device is said to be completely blocking ($I_R=0$).

In the case of the three circuits of figure 1, the maximum reverse voltage seen by each rectifier diode is 2Vm. So devices must be selected with reverse voltage (V_{rrm}) ratings of at least 2Vm.

Reverse Recovery Time (t_{rr}) - In general terms, reverse recovery time is a measure of the time needed for a rectifier diode to reach a state of complete blocking ($I_R=0$) upon the application of a reverse bias. Ideally, this time should be zero. In reality, however, there's a finite period of time in which a stored charge at the diode junction must be "swept away" before the device can enter its blocking mode. This stored charge is directly related to the amount of forward current flowing through the device just prior to the application of the reverse bias. Fortunately, since operating currents are very low in multiplier circuits, reverse recovery times are kept to a minimum. Nevertheless, t_{rr} plays an important role in multiplier design.

When selecting rectifier diodes, the frequency of the input signal to the multiplier network must be considered. For symmetrical signal inputs, the device chosen must be capable of switching at speeds faster than the rise and fall times of the input. If the reverse recovery time of the rectifier is too long, the efficiency and regulation of the circuit will suffer. In the worst case, insufficient recovery speeds will result in excessive device heating, as reverse power losses in the rectifier become significant. Continued operation in this mode usually results in permanent damage to the device.

The reverse recovery time (t_{rr}) specification is very dependent upon the circuit and the conditions being used to make the measurement. Several industry standard t_{rr} test circuits exist (figure 2 is the test circuit used for the GP02-40). Therefore, it's very important to note which test circuit is being referenced, as the same device may measure differently on different test circuits. Furthermore, the t_{rr} specification should be used for qualitative, not quantitative purposes, since conditions specified for t_{rr} measurement rarely reflect those found in actual "real life" circuit operation. The t_{rr} specification is most valuable when comparing two or more devices that are measured on the same circuit, under the same conditions.

Figure 3 shows the relationship between forward current and t_{rr} in the GP02-40. As you can see, decreasing current flow in the multiplier circuit makes it possible to use higher input frequencies. An increase in current flow has the opposite effect. Ideally, the multiplier network load should draw no current.

Peak Forward Surge Current (I_{fsm}) - A peak forward surge current rating is given for most rectifier diodes. Most often, this rating corresponds to the maximum peak value of a single half-sine wave (50 or 60Hz) which, when superimposed upon the devices rated load current (JEDEC method), can be conducted, without damage by the rectifier. This rating becomes important when considering the large capacitance associated with multiplier circuitry.

Surge currents can develop in multiplier circuits, due to capacitive loading effects. The large step-up turns ratio between primary and secondary of most high voltage transformers causes the first multiplier capacitor (C_1 , secondary side) to be reflected as a much larger capacitance into the primary. For example, a transformer with a turns ratio of 25 will cause a 1.0 uF capacitance to be reflected into the primary circuitry as a capacitance of $(1.0)(25)$ uF, or 625uF. At circuit turn-on, large currents will be developed in the primary side as this effective capacitance begins charging.

On the secondary side, significant surge currents can flow through the rectifiers during initial capacitor charging at turn-on. The addition of a series resistance (R_s in figure 1) can greatly reduce these current surges, as well

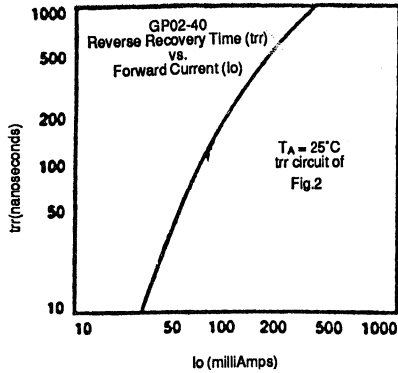
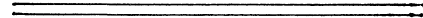

Figure 3

Trr as a function of forward current



as those in the primary circuitry. For example, the GP02-40 has a forward surge rating, I_{fsm} , of 15 amperes. Considering a maximum secondary voltage of 260 Vrms, 60Hz, the calculation of R_s is as follows:

$$R_s \geq V_{peak} / I_{fsm} \quad \text{eq.1}$$

$$R_s \geq (1.41)(260) / 15$$

$$R_s \geq 24.4 \text{ ohm}$$

Other Parameters - Of lesser significance are the forward current rating, I_o , and maximum forward voltage, V_f .

Forward current, I_o - As stated earlier, in the ideal multiplier configuration the load will draw no current. Ideally, the only significant current flow through the rectifiers occurs during capacitor charging. Therefore, devices with very low current ratings (hundreds of milliamperes) can be used. It must be noted, however, that the forward current and forward surge current ratings are related, since both are a function of silicon die area. Generally speaking, devices with a high surge current rating, I_{fsm} , will also have a high forward current, I_o , rating, and vice versa.

Forward Voltage, V_f - In practice, the forward voltage drop, V_f , of the rectifiers does not have a significant effect on the multiplier network's overall efficiency. For instance, the GP02-40 has a typical forward drop of 2.0 volts when measured at a current of 100 milliamperes. A half wave doubler with an 8KV output will have less than .05 percent ($2 \times 2V / 8KV$) loss in efficiency due to the forward voltage drops.

HIGHER ORDER CASCADE MULTIPLIER

Still higher voltages are possible by using the cascade multiplier circuit shown in figure 4. The output voltage is calculated as:

$$V_o = (n)(V_m), \text{ as } I_L \rightarrow 0 \quad \text{eq.2}$$

where n = number of capacitors or diodes, assuming equal value capacitors, ideal diodes and symmetrical signal input.

In theory, one can obtain any incremental output voltage increasing the value of n . In practice, however, voltage regulation and efficiency become increasingly poor as n increases. The potential for voltage arcing must also be considered as the value of n increases, and when higher output voltages are required. Careful mechanical design can minimize arcing, to a large extent.

From a pure circuits standpoint, voltage multipliers are relatively easy to design. The selection of circuit components, however, is one facet of the "overall design" that should not be taken for granted or trivialized. Careful consideration of all component parameters is the only way to ensure both reliable and predictable circuit performance. Put another way, ideal circuits require ideal circuit components.

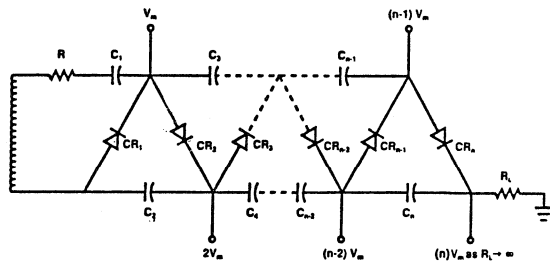

Figure 4

Cascade multiplier

To find the ideal rectifier for your voltage multiplier, consult the **General Instrument Power Semiconductor Division Data Book**. You can obtain a copy by phoning 516-933-3165, or by writing to General Instrument Corp., Power Semiconductor Division, 600 West John Street, Hicksville, NY 11802.

Transient Voltage Suppressors Ideally Suited for Automotive Applications or Harsh Environments

Gloria M.Luna
Automotive Applications Engineer

The combination of durability and high temperature performance has come together in the form of General Instrument's new, patented PAR (Passivated Anisotropic Rectifier)* process. Transient voltage suppressors produced by this process exhibit high temperature reverse bias stability, excellent transient energy capability, and low dynamic impedance, and are ideally suited for the harsh environments of automotive applications. In a standard diffused junction process, there are several conditions present that could affect the integrity of a device. These conditions become critical to the performance of the device as the junction temperature is increased and the device is stressed to the limits of its operation. They include the presence of a high field at the surface of the junction when a voltage is applied. The electric field (V/cm) that occurs over the depletion layer of a device determines the voltage capability of the device:

$$E(x) = \frac{dV(x)}{dx}$$

This field is not only present in the bulk of the device but also at the surface. When this electric field sees ionic contaminants on top of the surface and along the edge of the die, the contaminants will ionize and the resulting charge will distort the original field. This distortion can increase local leakage current and cause localized breakdown as well as thermal runaway. By growing an oxide directly on the surface of the junction layer, these contaminants can be eliminated. In addition, by employing a positive bevel angle construction, the field at the surface would be diminished to a point where it could not contribute to device degradation. General Instrument engineers have combined these features in a process that provides reliable devices under the high temperature conditions of the automotive environment as well as one that lends itself to state-of-the-art semiconductor manufacturing processes. Thus came the development of the PAR process.

*patented by General Instrument

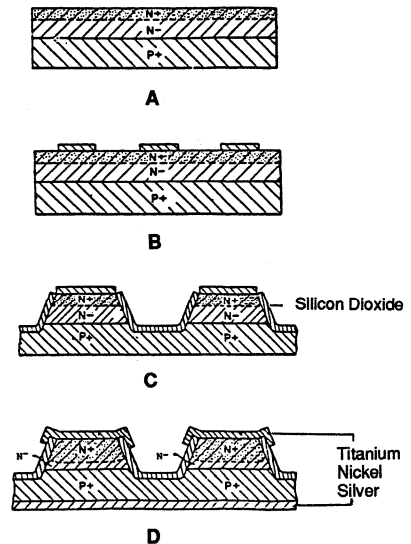

Figure 1

PROCESS TECHNOLOGY

As illustrated in Figure 1(A), we begin with a P+ device and an N- surface layer. We then diffuse in a shallow N+ layer, deposit and subsequently etch a silicon nitride layer that functions as a mask as shown in Figure 1(B). The resulting pattern is then anisotropically etched to form a mesa structure on the top side of the wafer. By utilizing this anisotropic process we are able to achieve a uniform 45 degree angle all around each die. We oxidize the silicon surface where there is no nitride, which results in a grown silicon dioxide layer that is ten times as thick as the silicon nitride. This oxide layer forms around the mesas but not on the original nitride as shown in Figure 1(C). As the N+ layer is driven deeper into the junction, a phenomenon occurs which results in a curvature between the N+ and the N- surface layers as illustrated by Figure 1(D). This curvature is essential in achieving higher breakdown voltages. The final step includes the removal of the top silicon nitride layer and the sintering of a metalization layer

composed of titanium, nickel, and silver deposited on the top and bottom surfaces. This is also illustrated in Figure 1(D).

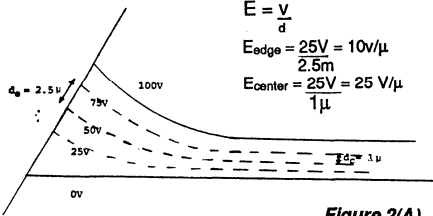

Figure 2(A)

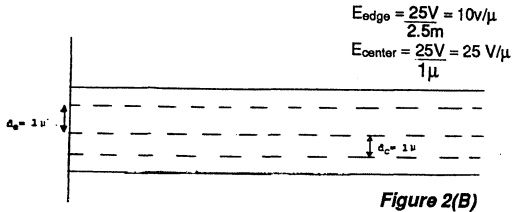

Figure 2(B)

This process is notable for the following reasons:

1. Reverse current measurements remain stable and uniform.
2. Complete stability during high temperature reverse bias and thermal cycling
3. Low electrical contact resistance.

This process results in several important features unique to the PAR construction. First, particle contamination is virtually eliminated by the use of a grown oxide to passivate the junction. Second, by utilizing a positive bevel angle construction, we are able to lower the field at the surface. Due to the fact that the reverse breakdown voltage of a device is determined by the width of the high ohmic region, the curvature of the N+/N- junction becomes an important design criteria in obtaining higher breakdown voltages at the surface of the silicon. This promotes a breakdown along the bulk of the junction rather than at the edge. As illustrated in Figure 2(A), the curvature of the junction results in an increase in the distances of the equipotential lines at the surface. By calculation, all of the breakdown occurs at the bulk of the device rather than at the edge because the field at the edge does not exceed the critical value of the layers of material outside of the silicon near the

junction (greater than 10V/μ). In contrast, the equipotential lines for a standard diffused junction device are illustrated in Figure 2(B). With the breakdown occurring at the edge of the junction, the incidence of high leakage and localized breakdown associated with field distortion is increased, particularly when the device is exposed to extreme environmental and operating conditions. In addition, this tailored junction affords the following advantages:

1. By having the breakdown occur over the large bulk area of the device, large energy surges can be safely handled without damage or deterioration to the device.
2. By modifying the edge of the device, the results under high temperature reverse bias are excellent.

AUTOMOTIVE TRANSIENTS

Electronic devices that operate in the automotive environment are subjected to very extreme conditions. Temperature, humidity, exposure to various liquids, vibration, voltage changes, and surge voltages are just some of the factors to be considered in the automotive environment. Temperatures can rise to as high as 200 degrees C in the engine compartment and as low as -20 degrees C. As a result, it is necessary that any electronic device be able to withstand these conditions and operate within reasonable limits so as not to degrade the performance of any system it may be operating in. Transients in the automotive environment cover a wide range of energy levels and time durations, as illustrated in Figure 3. These transients are distributed throughout the electrical system of an automobile and can occur at any time.

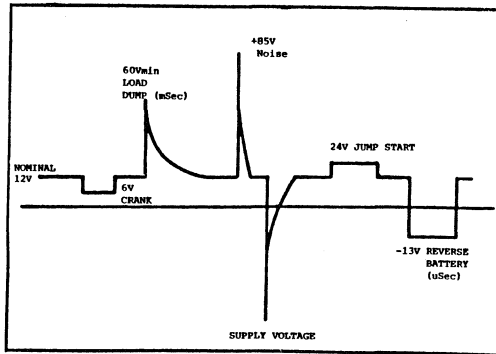

Figure 3

Possible automotive supply voltage variations

Some of the most serious types of transients are:

1. A load dump transient occurs when the alternator load is suddenly dropped due to battery disconnection. Voltages can range from 30 to 125V for up to 400 ms. This is considered the worst of all types of transients and was made a test requirement for all electrical systems and modules designed for the automotive industry back in the 1970's. See Figure 4

2. Transient voltages generated when the inductive loads (relays, solenoids, and switches) are turned off. See Figure 5.

3. Transient voltages generated when the ignition switch is turned off. 4. Transient voltages generated by inductive or capacitive coupling when electrical equipment (such as the ignition system) is turned on.

By connecting a transient voltage suppressor across the output of a circuit or connecting them within the circuit, you can protect delicate components and systems by clamping these transient voltages. Because the failure threshold level of a system is determined by its weakest component, it is wise to insure that a TVS would be able to withstand all of these conditions.

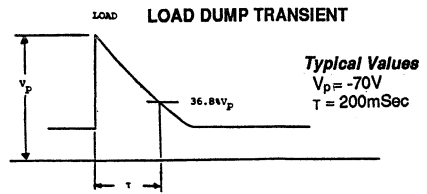

Figure 4

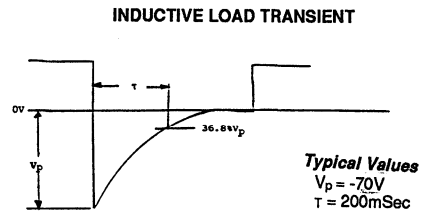

Figure 5

RELIABILITY

Due to this increased focus on reliability under harsh environmental conditions, the ability to quantify reliability has become an important criteria in selecting components. Failure modes fall into two broad categories--those related to defects in the silicon die, and those related to packaging of the die. Die defects relate to field distortion, oxide defects, surface charge or microcracking. By using devices manufactured with the PAR process, the incidence of these types of failures is greatly reduced. These failures can be provoked by high temperature reverse bias testing. In this test, the devices are reverse biased by applying 80% of the rated reverse voltage to the device and heating the device to at least 150 degrees C. This test can run anywhere from 250 to 1000 hours to insure device durability. Shown in Figure 6 are the results of HTRB testing on PAR produced transient voltage suppressors

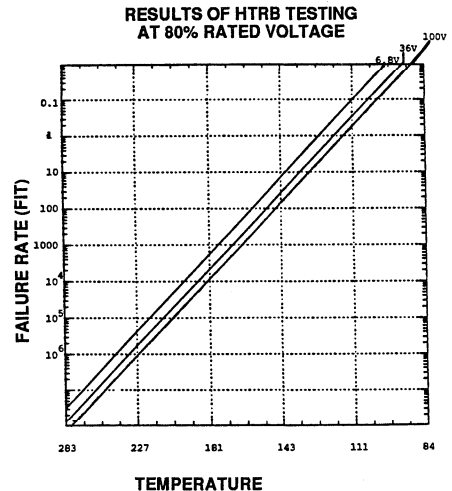

Figure 6

Definition: Failures > 5μA IR at 25°C
Failure Rate = - fails / 10⁹hi

rated at 6.8V, 36V, and 100V. In addition, reverse leakage remains within a very tight distribution and very little drift is observed in values before and after test. Packaging defects can occur from fatiguing of the bond or the presence of atmospheric vapor onto the die surface. Particularly in the automotive environment, semiconductor devices can be subject to thermal and electrical stress causing cracking, separation or voiding of the bond between the die and the lead. These conditions can lead to degrading operation and eventually, thermal runaway. By thermally cycling the device from low (typically -65 degrees C) to elevated temperatures (typically 150 degrees to 170 degrees C) with a dwell time of 5 minutes at each temperature, the bond can be stressed to the point of failure to insure the integrity of the device. The results of temperature cycling for PAR devices is shown in Figure 7.

RESULTS OF TEMPERATURE CYCLING TESTING

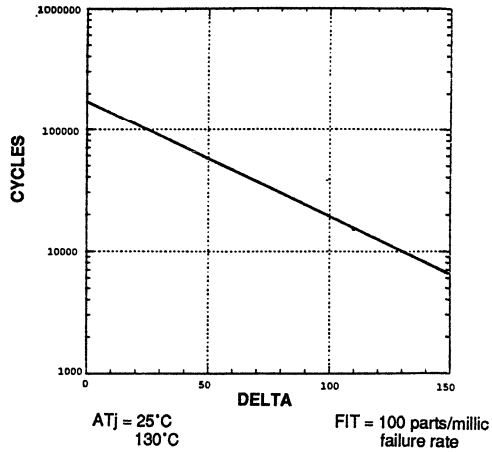

Figure 7

PART NUMBERS

The devices are available in three different power ranges utilizing the following part numbers:

- P4KA** (400 Watts) **P6KA** (600 Watts)
6.8V to 43V 6.8V to 43V
- 1.5KA** (1500 Watts)
6.8V to 43V
- TAGL41** (400 Watts Surface Mount)
6.8V to 43V

**PACKAGING
BULK - TAPE AND REEL**

**GENERAL
INSTRUMENT**

PKG. CODE	PACKAGING DESCRIPTION
1 Bulk
3 26MM Horizontal Taping and Ammo Packing
4 Standard Horizontal Reel, Class 1 (Metric 52.4MM)
6 Avisert, Cathode Up, Cathode First Off Reel
8 Avisert, Cathode Up, Cathode First Off Ammo Pack
10 Avisert, Cathode Down, Anode First Off Reel
12 Avisert, Cathode Down, Anode First Off Ammo Pack
14 Panasert, Cathode Up, Cathode First Off Reel
15 Panasert, Cathode Up, Anode Off First, Ammo Pack
16 Panasert, Cathode Up, Cathode First Off Ammo Pack
18 Panasert, Cathode Down, Anode First Off Reel
20 Panasert, Cathode Down, Anode First Off Ammo Pack
22 Bulk Pack for Special Axial-Leaded Formed Devices
23 Standard Horizontal Ammo Pack, Class I (Metric 52.4mm)
25 GL41 SMD 12MM Tape, 7" Diameter Paper Reel
26 GL41 SMD 12MM Tape, 13" Diameter Paper Reel
27 SMD, 16 MM Tape, 7" Diameter Reel
28 Special Carton Packing method for Tube Packaging Products
32 GL34 SMD, 8MM Tape, 7" Diameter Paper Reel
33 GL34 SMD, 8MM Tape, 13" Diameter Paper Reel
34 Tab Mounted EFR8 Chip, 16MM, 13" Diameter Reel
35 Bulk, Axial-Leaded Conductive Packaging
36 Standard Horizontal Reel, Class 1 (Metric 52.4MM)
	Conductive Packaging
37 Bulk, TO-220, TO3P Conductive Tubes
38 Bulk, Conductive Packaging for Bridge Rectifier
39 Miscellaneous Non-Standard T&R Packaging
40 Euroform, Reel, Cathode First Off Reel, Lead Coated
42 Euroform, Reel, Cathode Last Off Reel, Lead Coated
44 Standard Horizontal Reel (Metric) 5MM Component Spacing for DO-201 Packages
45 Tube Packaging for TO-220, TO-3P, and In Line Bridge Rectifier
46 GL41 SMD 12MM Tape, 7" Diameter Plastic Reels
47 GL41 SMD 12MM Tape, 13" Diameter Plastic Reels
48 GL34 SMD 8MM Tape, 7 " Diameter Plastic Reels
49 GL34 SMD 8MM Tape, 13" Diameter Plastic Reels

*Also available for all packaging Electro-Static-Protection by adding the number "50" to the existing codes.
For example, "51" would be Bulk, Electro-Static Packaging. "54" would be T/R, Electro-Static Packaging.*

REEL PACKAGING

Axial leaded devices are packed in accordance with EIA Standard RS-296-E
and the diagrams given below which refer to these specifications.

COMPONENT CASE TYPE	UNITS PER REEL	COMPONENT SPACING "A" FIG. 1		Table 1 TAPE SPACING "B" FIG. 1		REEL DIMENSION "D" FIG.2		MAX. OFF ALIGNMENT "E" FIG. 1		GROSS WEIGHT PER REEL		
		ea.	In.	mm	In.	mm	In.	mm	In.	mm	lbs.	kg.
		1.5KA (PAR)	2000	.200	5.0	2.06	52.4	12.0	305	.047	1.2	7.1
DO15	3500	.200	5.0	2.06	52.4	12.0	305	.047	1.2	4.00	1.81	
DO201AD	1200	.395	10.0	2.06	52.4	12.0	305	.047	1.2	3.60	1.63	
DO204AP	4000	.200	5.0	2.06	52.4	12.0	305	.047	1.2	5.80	2.60	
DO204MB	4000	.200	5.0	2.06	52.4	12.0	305	.047	1.2	3.74	1.70	
DO41	5000	.200	5.0	2.06	52.4	12.0	305	.047	1.2	4.80	2.20	
G3/G4	1500	.395	10.0	2.06	52.4	12.0	305	.047	1.2	4.80/4.40	2.20/2.00	
GL34 Surface Mount	2500/7000	.157	4.0	—	—	7/13	178/330	See Fig. 6		.471/1.49	.214/.68	
GL41 Surface Mount	1500/5000	.157	4.0	—	—	7/13	178/330	See Fig. 6		.471/1.49	.214/.68	
GP10E Vertical	2000	.500	12.7	—	—	12.0	305	.079	2.0	2.29	1.04	
GP10E Horizontal	4000	.200	5.0	2.06	52.4	12.0	305	.047	1.2	3.04	1.38	
GP20	1200	.395	10.0	2.06	52.4	12.0	305	.047	1.2	4.40	2.00	
MPG06	5000	.200	5.0	2.06	52.4	12.0	305	.047	1.2	3.74	1.70	
P600	700	.395	10.0	2.06	52.4	12.0	305	.047	1.2	5.00	2.30	

Table 2
Metric Spec

Component Body Diameter	Components Spacing "A"(Lead to Lead)	Inside Tape Spacing "B"	Cumulative Pitch Tolerance
0mm to 5mm (0" to .197")	5.0mm+0.5mm (.197"+.020")	26mm+0.75mm (1.024"+.030")	Not to
0mm to 5mm (0" to .197")	5.0mm+0.5mm (.197"+.020")	52.4mm+1.5mm (2.062"+.059")	Exceed 1.5mm (.059") over
5.01mm to 10mm (.197" to .394")	10mm+0.5mm (.394" ± .020")	52.4mm+1.5mm (2.062"±.059")	6 Consecutive

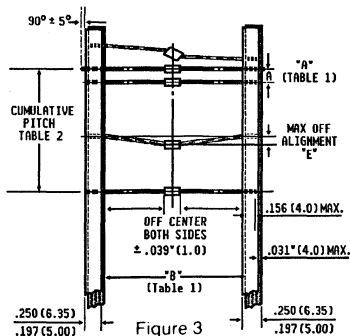

Figure 3
Dimensions in inches and (millimeters)

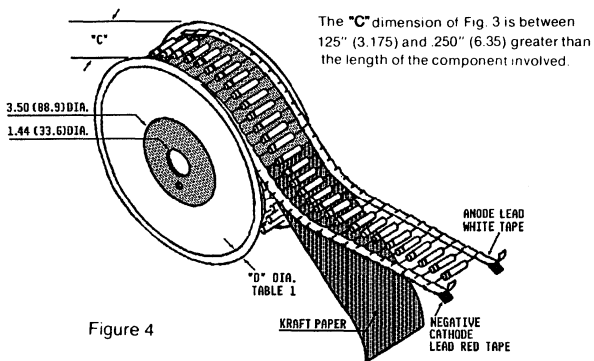

Figure 4

**GENERAL
INSTRUMENT**

NEW BULK PACKAGES

DEVICE TYPE	BOX SIZE		QUANTITY	GROSS WEIGHT		
	INCHES	CM		EA.	LBS.	KG
GL34 SURFACE MOUNT	8.0 x 3.5 x 1.0	20.3 x 8.8 x 2.54	8000	0.55	0.25	
GL41 SURFACE MOUNT	8.0 x 3.5 x 1.0	20.3 x 8.8 x 2.54	4000	1.03	0.47	
DO15	11.75 x 5.125 x 2.5	29.8 x 13.0 x 6.3	4000	3.85	1.75	
DO201AD	11.75 x 5.125 x 2.5	29.8 x 13.0 x 6.3	1500	4.41	2.0	
DO204AP	11.75 x 5.125 x 2.5	29.8 x 13.0 x 6.3	4000	3.75	1.7	
DO204MB	11.75 x 5.125 x 2.5	29.8 x 13.0 x 6.3	5000	3.15	1.45	
DO41/MPG06	11.75 x 5.125 x 2.5	29.8 x 13.0 x 6.3	5000	2.38/2.20	1.08/1.0	
G4/G3	11.75 x 5.125 x 2.5	29.8 x 13.0 x 6.3	3000/2000	5.07 / 5.29	2.3/2.4	
GP20	11.75 x 5.125 x 2.5	29.8 x 13.0 x 6.3	1500	3.75	1.7	
J,JTX1N483B, 1N645, 1N645-1	8.0 x 3.5 x 1.0	20.3 x 8.8 x 2.54	1000	0.77	0.35	
J, JTX1N3611, 1N4245, 1N5614	8.0 x 3.5 x 1.0	20.3 x 8.8 x 2.54	500	0.55	0.25	
J, JTX1N4942, 1N5615, 1N5802	8.0 x 3.5 x 1.0	20.3 x 8.8 x 2.54	500	0.55	0.25	
J, JTX1N5415, 1N5550, 1N5625, 1N5807	12.0 x 3.6 x 2.5	30.4 x 9.1 x 6.3	1000	2.50	1.1	
P600	11.75 x 5.125 x 2.5	29.8 x 13.0 x 6.3	750	3.7 2	1.69	
P6KE	11.75 x 3.5 x 1.0	29.8 x 8.8 x 2.54	2000	1.93	0.87	
DF-M/DF-S	ANTI-STATIC PLASTIC TUBES	19.0 LENGTH	48.2 LENGTH	50	0.12	0.05
TO-220, CT	ANTI-STATIC PLASTIC TUBES	20.5 LENGTH	52.0 LENGTH	50	0.306	0.14
TO3P	ANTI-STATIC PLASTIC TUBES	20.5 LENGTH	52.0 LENGTH	30	0.572	0.26
KBPM/2KBPM	ANTI-STATIC PLASTIC TUBES	18.5 LENGTH	47.0 LENGTH	30	0.21	0.09
AR,ARS	PLASTIC BAGS			200	0.84	0.38
WM, WG	PLASTIC BAGS			100	0.37	0.17
GPP1, EFR1, 3, 5	CHP TRAY	2.0 x 2.0 x .35	5.1 x 5.1 x 0.9	100	0.042	0.019
GPP5, EFR8	CHIP TRAY	2.0 x 2.0 x .35	5.1 x 5.1 x 0.9	100	0.044	0.020
BC	PAPER BOX	9.2 x 5.0 x 2.5	23.4 x 12.7 x 6.3	100	3.08	1.4
KBU4,6,8	PVC TRAY	12.2 x 6.1 x 1.5	30.9 x 15.5 x 3.8	250	4.63	2.1
KBL	PVC TRAY	12.2 x 6.1 x 1.5	30.9 x 15.5 x 3.8	300	4.19	1.9
KBPC1035W	PVC TRAY	12.4 x 12.4 x 1.4	31.4 x 31.4 x 3.6	100	5.07	2.3
KBPC8	PVC TRAY	12.4 x 12.4 x 1.1	31.4 x 31.4 x 2.9	200	3.31	1.5
KBPC1,KBPC6	PVC TRAY	12.4 x 12.4 x .88	31.4 x 31.4 x 2.2	250	1.94/2.64	.88/1.2
KBPC 10/35	PVC TRAY	12.4 x 12.4 x 1.4	31.4 x 31.4 x 3.6	100	5.29	2.4

AMMO BOX PACKAGING

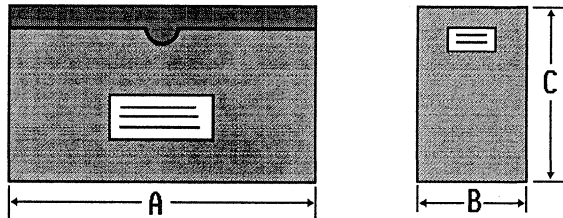

Packaging	Available Product Outlines	Packaging Codes	Dimension "A"	Dimension "B"	Dimension "C"	Quantity Box
26MM Horizontal Ammo Pack	DO-41 GI, DO-15	PKG 3	9.7" (247MM)	1.7" (44MM)	3.7" (95MM)	3K 1.5K
52MM Horizontal Ammo Pack	G1, DO-41 DO15 DO201AD, G3 P600	PKG 23	10.0" (254MM)	3.1" (79MM)	4.3" (110MM)	3K 2K 1K 3K
Vertical (Avisert, Panasert) Ammo Pack	GP10-E, RGP10-E 0.25" (0.65MM) Lead Diameter Only	PKG 8, 9 12, 13, 16 17, 20, 21	12.9" (328MM)	1.7" (42MM)	7.9" (200MM)	2K

**GENERAL
INSTRUMENT**

PACKAGING METHODS FOR VERTICLE TAPING

FIG. 1

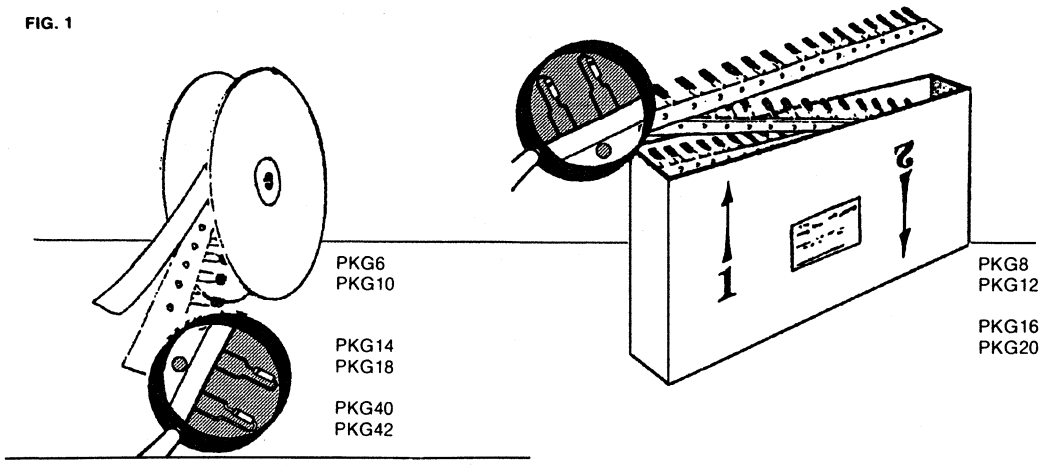

Avisert: PKG6 Panasert: PKG14 Euroform: PKG40
 PKG8 PKG16 PKG41
 PKG10 PKG18 PKG42
 PKG12 PKG20 PKG43

FIG. 2

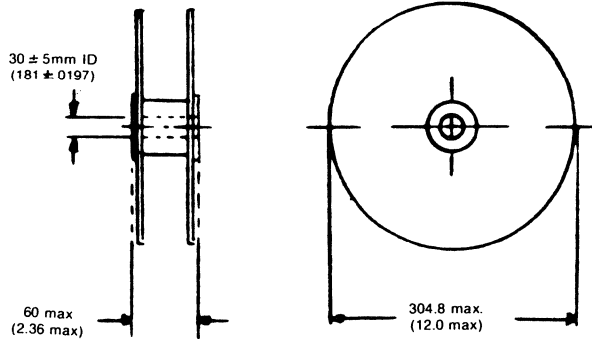

ALL DIMENSIONS
 IN MILLIMETERS AND INCHES

Package per EIA JEDEC standard RS-468 Available on reels or fan fold box (ammo pack)

Available only for DO41 case style products utilizing 0.65mm (.025") or 0.76mm (.30") diameter leads for Panasert and Avisert Tape and Reeling.

Available only for GP10 products only utilizing 0.65mm (.025") diameter leads for Euroform Tape and Reeling by adding suffix "E" (GP10GE, 1N4004GPE)

**GENERAL
 INSTRUMENT**

VERTICLE REEL PACKAGING

ALL DIMENSIONS
IN MILLIMETERS AND (INCHES)

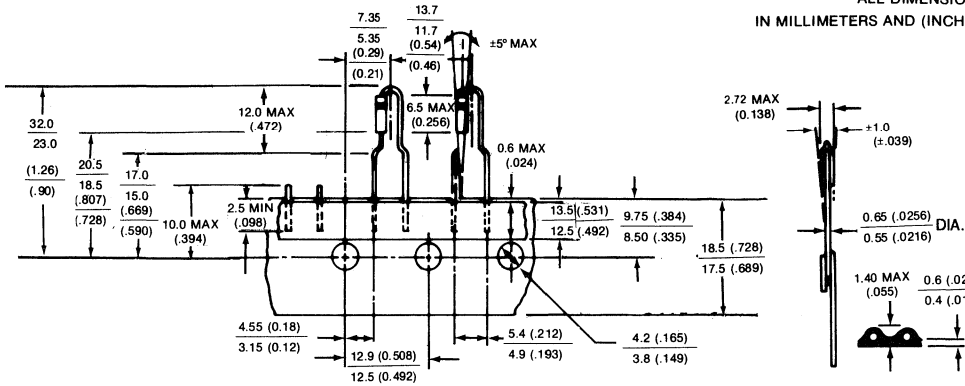

FIG. 3 - EURO FORM

Available only for GP10 products utilizing 0.65mm (.025) diameter leads for Euroform Tape and Reeling by adding suffix "E" (GP10GE, 1N4004GPE). Lead coating is standard.

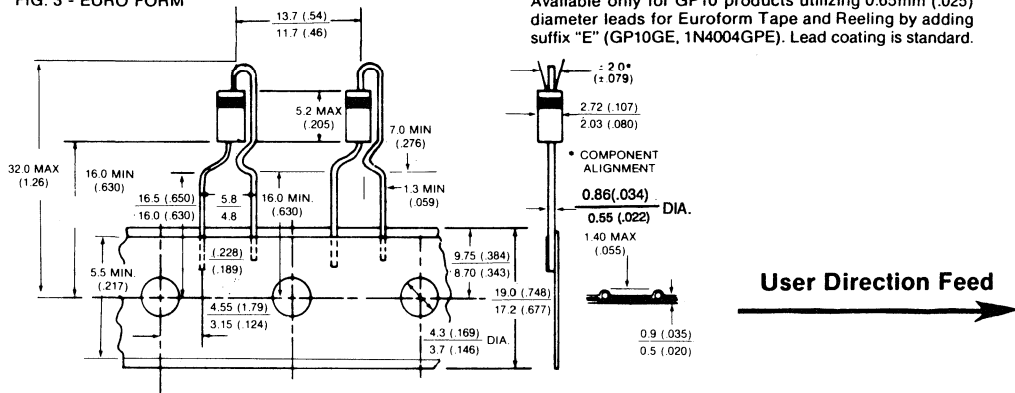

FIG. 4 - PANASERT

Available only for DO41 case style products utilizing 0.65mm (.025) or 0.76mm (.30) diameter leads for Panasert and Avisert Tape and Reeling. Lead coating is not available.

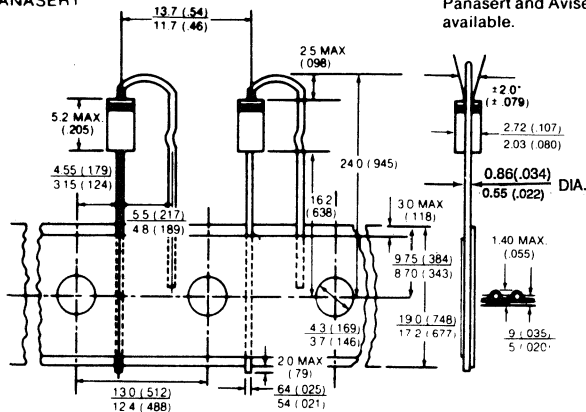

FIG. 5 - AVISERT

Standard polarity cathode oriented away from sprocket holes
(Optional polarity cathode oriented toward sprocket holes)

**GENERAL
INSTRUMENT**

SURFACE MOUNT PACKAGING

Packed per EIA/JEDEC Standard RS-481

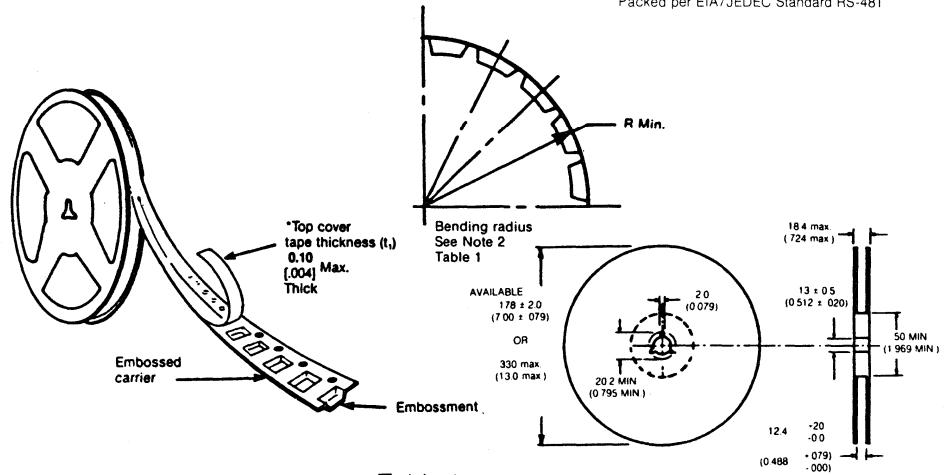

Table 1

8, 12, 16, MM Embossed Tape						All Dimensions in Millimeters and (Inches)				
Tape Size	D	E	P ₀	t	A ₀ B ₀ K ₀					
8, 12, MM	1.5 (.059)	1.75±0.10 (.069±.004)	4.0±.10 (.157±.004)	0.400 (.016)	See Note 1 Table 2					Constant Dimensions
Product Type	Tape Size	Max. B ¹	Min. D ¹	F	Max. K	P ²	Min. R	W	P	Variable Dimensions
GL34	8MM	4.2 (.165)	1.0 (.039)	3.5±0.05 (.138±.002)	2.4 (.094)	2.0±0.05 (.079±.002)	25 (.984)	8.0±.30 (.315±.012)	4.0±0.10	
GL41	12MM	8.2 (.323)	1.5 (.059)	5.5±0.05 (.217±.002)	4.5 (.177)		30 (1.181)	12.0±.30 (.472±.012)		

es:
 o Bo Ko are determined by component size. The clearance between the component and the cavity must be within 0.05 min. to 0.5 max. for 8MM tape and
 i min to 0.650 max. for 12 MM tape.
 addition the components cannot rotate more than 20° within the determined cavity.
 ape and components will pass around radius "R" without damage.

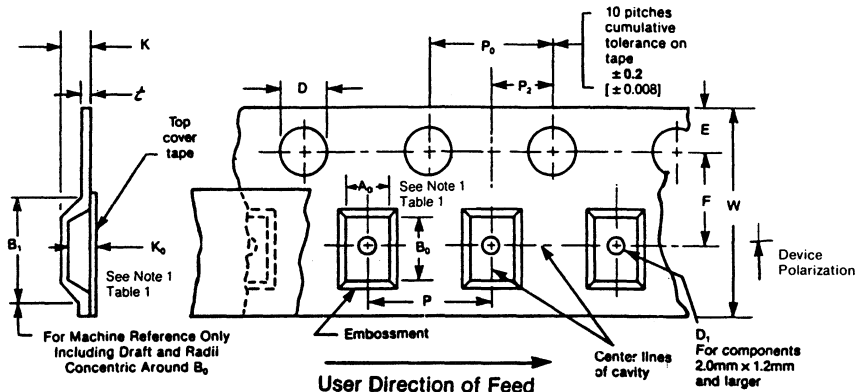

FIG. 6

**GENERAL
INSTRUMENT**

PSD SALES OFFICES**Southeast Regional Sales Office**

General Instrument Corporation
6855 Jimmy Carter Blvd.
Norcross, GA 30071
Tel: (404) 446-1265
Fax: (404) 446-1286

Northeast Regional Sales Office

General Instrument Corporation
120 Andrews Road
Hicksville, NY 11802
Tel: (516) 933-3200
Fax: (516) 433-4412

Central Regional Sales Office

General Instrument Corporation
85 W. Algonquin Rd. Suite 300
Arlington Heights, IL 60005
Tel: (708) 364-5880
Fax: (708) 364-0649

Western Regional Sales Office

General Instrument Corporation
21601 Vanowen Street, Suite 205
Canoga Park, CA 91303
Tel: (818) 992-0982
Fax: (818) 992-1658

UNITED STATES**ALABAMA**

Electramark
4950 Corporate Drive
Suite 130L
Huntsville, 35805
Tel: (205) 830-4400
Fax: (205) 830-4406

ARIZONA

Fred Board Associates
7353 Sixth Avenue
Scottsdale, 85252
Tel: (602) 994-9388
Fax: (602) 994-9477

Fred Board Associates
1041 W. Comababi
Tucson, 85704
(602) 299-1508

CALIFORNIA

Prosales
5625 Ruffin Road Suite 200
San Diego, 92123
Tel: (619) 571-1133
Fax: (619) 571-1313

Ewing-Foley
895 Sherwood Avenue
Los Altos, 94022-9990
Tel: (415) 941-4525
Fax: (415) 941-5109

Ewing-Foley
185 Linden Avenue
Auburn, 95603
Tel: (916) 885-6591
Fax: (916) 885-6594

Select Electronics
14730 Beach Blvd.
Bldg. F, Suite 106
La Mirada, 90638
Tel: (714) 739-8891
Fax: (714) 739-1604

CANADA

Pipe-Thomson Ltd.
5468 Dundas St. West
Suite 206
Islington, Ontario
M9B 6E3
Tel: (416) 236-2355
Fax: (416) 236-3387

Davetek Marketing
37-4429 Kingsway
Burnaby, B.C.
V5H 2A1
Tel: (604) 430-3680
Fax: (604) 435-5490

COLORADO

Lindberg Associates
6140 E. Evans Avenue
Denver, 80222
Tel: (303) 758-9033
Fax: (303) 758-5863

FLORIDA

C Associates
251 Maitland Avenue
Suite 101
Altamonte Springs, 32701
Tel: (407) 831-1717
Fax: (407) 831-8767

C Associates
23083 S.W. 61st Street
Boca Raton, 33428
Tel: (407) 488-6090
Fax: (407) 451-4927

GEORGIA

Electramark
6030 Unity Drive
Suite H
Norcross, 30071
Tel: (404) 446-7915
Fax: (404) 263-6389

ILLINOIS

Metcom Associates, Corp.
2 Talcott Road
Park Ridge, 60068
Tel: (312) 696-1490
Fax: (312) 696-2568

INDIANA

Valentine & Associates
1000 North Madison Avenue
P.O. Box 242
Greenwood, 46142
Tel: (317) 888-2260
Fax: (317) 881-4904

Valentine & Associates
1638 Lincolnway East
Southbend, 46613
Tel: (219) 288-7070
Fax: (219) 233-1779

Valentine & Associates
629 W. Lincoln Road
Kokomo, 46902
Tel: (317) 453-1118
Fax: (317) 453-1007

IOWA

Dy-Tronix Inc.
23 Twixt Town Road
Cedar Rapids, 52402
Tel: (319) 377-8275
Fax: (319) 377-9163

KANSAS

Dy-Tronix Inc.
1999 Amidon
Suite 322
Wichita, 62703
Tel: (316) 838-0884
EASYLINK 62914257

Dy-Tronix Inc.
5001 College Blvd.
Suite 106
Leawood, 66211
Tel: (913) 339-6333
Fax: (913) 339-9449

MASSACHUSETTS

Comp. Rep. Assoc. Inc.
100 Everett Street
Westwood, 02090
Tel: (617) 329-3454
Fax: (617) 329-6395

MEXICO

Panamtek
Av. Union No. 163-402
Sector Juarez
C.P. 44100, Guadalajara, Jalisco
Tel: 1152-36-303029
Fax: 1152-36-303115

MICHIGAN

Rathsburg Associated
34605 Twelve Mile Rd.
Farmington Hills,
48331-3262
Tel: (313) 489-1500
Fax: (313) 559-1405

MINNESOTA

High Technology
11415 Valleyview Road
Eden Prairie, 55344
Tel: (612) 944-7274
Fax: (612) 944-3229

MISSOURI

Dy-Tronix Inc.
3407 Bridgeland
Bridgeton, 63044
Tel: (314) 291-4777
Fax: (314) 291-3861

NEW JERSEY (TRI-STATE)

Janco Technology
71 Grand Avenue
Palisades Park, 17650
Tel: (201) 941-4008
Fax: (201) 941-4631

SALES OFFICE

NEW MEXICO

Q.A. Electronics
7101 Prospect Place N.E.
Suite 10
Albuquerque, 87110
Tel: (505) 888-1121
Fax: (505) 883-9044

NEW YORK

Quality Components Inc.
116 E. Fayette Street
Manlius, 13104
Tel: (315) 682-8885
Fax: (315) 682-2277

Quality Components Inc.
3343 Harlem Road
Buffalo, 14225
Tel: (716) 837-5430
Fax: (716) 837-0662

NORTH CAROLINA

Zucker Associates Inc.
P.O. Box 19868
Raleigh, 27619
Tel: (919) 782-8433
Fax: (919) 782-8476

OHIO

Makin & Associates Inc.
3165 Linwood Road
Cincinnati, 45208
Tel: (513) 871-2424
Fax: (513) 871-2524

Makin & Associates Inc.
32915 Aurora Road
Solon, 44139
Tel: (216) 248-7370
Fax: (216) 248-7372

Makin & Associates Inc.
6400 Riverside Drive
Bldg. A
Dublin, 43017
Tel: (614) 793-9545
Fax: (614) 793-0256

OKLAHOMA

Comptech Sales, Inc.
9810 E. 42nd Street
Suite 219
Tulsa, 74146
Tel: (918) 622-7744
Fax: (918) 660-0340

OREGON

Electronic Component Sales
15255 S.S. 72nd Avenue
Suite "C"
Tigard, 97224
Tel: (503) 245-2342
Fax: (503) 684-6436

PENNSYLVANIA

Bresson Associates
107 Forrest Avenue
Narberth, 19072
Tel: (215) 664-6460
Fax: (215) 664-7020

Russell F. Clark
10517 Lindberg Avenue
Pittsburg, 15235
Tel: (412) 242-9500
Fax: (412) 242-9505

PUERTO RICO

Isla Caribe Electro Sales Inc.
Calle Alejandrino
C#5 Villa Clementina
Guaynabo, 00657
Tel: (809) 720-4430
Fax: (809) 720-1097

TEXAS

Comptech Sales, Inc.
2401 Gateway Drive
Suite 114
Irving, 75063
Tel: (214) 751-1181
Fax: (214) 550-8113

Comptech Sales, Inc.
11130 Jollyville Road
Suite 200
Austin, 78759
Tel: (512) 343-0300
Fax: (512) 345-2530

Comptech Sales, Inc.
15415 Katy Freeway
Suite 102
Houston, 77094
Tel: (713) 492-0005
Fax: (713) 492-6116

UTAH

Lindberg Associates
3760 S. Highland Drive
Salt Lake City, 84106
Tel: (801) 227-2643

WASHINGTON

Electronic Component Sales
9311 S.E. 36th Street
Mercer Island, 98040-3795
Tel: (206) 232-9301
Fax: (206) 232-1095

WISCONSIN

Metcom Assoc. Corp.
237 S. Curtis Road
West Allis, 53214
Tel: (414) 476-1300
Fax: (414) 476-4368

GENERAL INSTRUMENT INTERNATIONAL SALES OFFICES

**EUROPEAN HEADQUARTERS
AND GERMANY, AUSTRIA AND
SWITZERLAND**

General Instrument
Deutschland GmbH
FreischutzstraBe 96
8000 Munchen 81
Tel.: 089/95997-0
Telex: 524523
Fax: 089/9570489

FRANCE, PORTUGAL AND SPAIN

General Instrument France
9/11 Rue G. Enesco
94008 Creteil Cedex
Tel.: 33 (1) 43771263
Telex: 262435
Fax: 011-33-143-99-1524

ITALY

General Instrument Italia S.R.L.
Via Cantu 11-20092
Cinisello Balsamo (Milano)
Fax: 02/66010324
Telex: 320348
Fax: (852)3-7239239

UNITED KINGDOM

General Instrument (UK)
Limited, Power Semiconductor Div.
Chelworth Industrial Estate
Cricklade, Swindon, Wiltshire,
England SN6 6HQ,
Tel: (0793)752307
FAX: (0793) 751419

Power Semiconductor Div.
Semitron Industries Limited,
Chelworth Industrial Estate,
Cricklade, Swindon, Wiltshire,
England SN6 6HQ,
Tel: (0793) 751151
FAX: (0793)751808
Telex: 44848

HONG KONG

General Instrument Hong Kong Ltd.
Room 1104-1107, Tower B, Mandarin Plaza
14 Science Museum Road
Tsimshatsui, East, Kowloon, Hong Kong
Tel.: 3-7226577
Telex: 54606 GIHKHX
Fax: (852)3-7239239

JAPAN

General Instrument Japan, Ltd.
5F4-1-13 Toronomo
Minato-Ku, Tokyo, Japan 105
Tel.: (03)437-0281
Fax: 9-011-81-3434-3938(GIJ)

General Instrument Japan, Ltd.
Toyosaki Bldg.
7F, 18-21, Chayamachi, Kita-Ku
Osaka, Japan 530
Tel.: 06-375-0606
Fax: 06-375-0693

SINGAPORE

General Instrument HK Ltd.
1 Marine Parade Central
#03-09 Parkway Builder's Centre
Singapore 1544
Tel: 3444711
Telex: GISPORE RS 24424
Fax: (65) 3446878

TAIWAN

General Instrument of Taiwan, Ltd.
233 Pao Chiao Road
Tsin Tien, Taipei, Taiwan
Tel: 9145531/9171469
Telex: 34297 GITSEAMK
Fax: 9146697/9175991

GENERAL INSTRUMENT INTERNATIONAL SALES OFFICES

GERMANY**Distributors**

Electronic 2000 Vertriebs-AG
Stahlgruberring 12
8000 Munchen 82
Tel.: 089/42001-0
Telex: 522561
Fax: 089/42001129

Elkose GmbH
Bahnhofstr. 44
7141 Moglingen
Tel.: 07141/4870
Telex: 7-264472
Fax: 07141/487210

Enatechnik GmbH
Schillerstr. 14
2085 Quickborn
Tel.: 04106/612-0
Telex: 213590
Fax: 04106/612268

Rutronik Elektromische
Bauelemente GmbH
RSC-Halbleiter GmbH
Industriestr. 2
7536 Ispringen
Tel.: 07231/8010
Telex: 783650
Fax: 07231/82282

Semitron W Rock GmbH
Im Gut 1
7891 Kussaberg 6
Tel.: 07742/7011
Telex: 7-921472
Fax: 07742/6901

Servitronic GmbH
Uhlandstr. 20-25
1000 Berlin 12
Tel.: 030/8826402
Telex: 1-83557
Fax: 030/8825934

Setron Schiffer Elektronik
Friedrich-Seele-Str. 3A
3300 Braunschweig
Tel.: 0531/80980
Telex: 952812
Fax: 0531/805-799

Spoerle Elektronik K.
Max-Planck-Str. 1-3
6072 Dreieich
Tel.: 06103/3040
Telex: 4-17903/417983
Fax: 06103/304201

Distributor for MIL-DIODEN

Asternetics GmbH
Wettersteinstr. 2
8028 Taufkirchen
Tel.: 089/6129000
Telex: (17) 896047
Fax: 089/6128198

ITALY**Agent and Distributor****Marche Abruzzi Area**

Adimpex Adriatica
Importazioni/Esportazione S.R.L.
Box 116-SS16-KM314-785
60022 Castellfidardo (AN)
Tel.: 071/7819012/013
Telex: 561183
Fax: 071/7819077

Distributors:

Emilia
Hellis di B. Prati S.A.S.
Via S. Benedetto 22/24
41049 Sassuolo (Modena)
Tel.: 0536/802562-804104
Fax: 0536/802343

Malpassi S.R.L.
Via Baravelli, 1
40012 Calderara di Reno (BO)
Tel.: 051/727252-727378
Telex: 583118
Fax: 051/727515

Lazio

3C E. Elettronica S.R.L.
V.le Laurentina, 50
00142 Roma
Tel.: 06/5412303/4
Telex: 610005
Fax: 06/5424033

Lombardia

Distrel S.R.L.
Via Rizzo, 8
20151 Milano
Tel.: 02/38001087 380820
Fax: 02/38001154

Kontron Instruments S.P.A.
Via Fantoli, 16/15
20138 Milano
Tel.: 02/50721
Telex: 312288
Fax: 02/5060918

Lombardia

Lasi Elettronica S.P.A.
Via F. Testi 280
20124 Milano
Tel.: 02/66101370
Fax: 02/66101385

Moxel S.R.L.
Via Frova, 34
20092 Cinisello Balsamo (Milano)
Tel.: 02/61290521
Telex: 352045
Fax: 02/6172582

SCEL S.R.L.
Via Stelvio 9
20026 Novate Milanese
Tel.: 02/3546252
Telex: 351582
Fax: 02/3542262

Piemonte

Adveco S.r.l.
P.za Bendini, 5
10097 Collegno (TO), Italy
Tel.: 011/4053277
Telex: 011/4050488

RG2 Elettronica
Via Rosa Luxemburg 12/14
10093 Collegno (TO), Italy
Tel.: 011/725665/712289
Telex: 224335/Telefax: 011/726705

TOSCANA

Welt Electronic
Via R. Bardazzi, 62/68
50127 Firenze, Italy
Tel.: 055/4379933-4376989
Telex: 580347
Telefax: 055/435728

Veneto

Idac Elettronica S.P.A.
Via Verona, 8
35010 Busa Di Vigona (PD)
Tel.: 049/8931644
Telefax: 049/8931689

GENERAL INSTRUMENT INTERNATIONAL SALES OFFICES

UNITED KINGDOM**Distributors**

Farnell Electronic Components Limited
Canal Road
Leeds
Yorkshire LS12 2TU
Tel: 0532 790101
Fax: 0532 636311
Tlx: 55147

Hunter Electronic Components Ltd.
Unit 3, Central Estate
Denmart Street
Maidenhead
Berkshire SL6 7BN
Tel: 0628 75911
Fax: 0628 75611
Tlx: 848946

Polar Electronics Limited
Cherry Court Industrial Estate
Leighton Buzzard
Bedfordshire LU7 8YY
Tel: 0525 377093
Fax: 0525 378367
Tlx: 825238

Rodgers Agencies
126 Orangefield Crescent
Belfast
BT6 9GJ
Tel: 0232 704985
Fax: 0232 792563

RS Components Limited
P.O. Box 99
Corby
Northants NN17 9RS
Tel: 0536 201234
Fax: 0536 201501
Tlx: 342512

STC Electronics Distribution
Edinburgh Way
Harlow
Essex CMO 2DF
Tel: 0279 626777
Fax: 0279 626777 ext: 3233
or 0279 441687
Tlx: 818801

VSI Electronics UK Ltd.
Roydonbury Industrial Estate
Horsecroft Road
Harlow
Essex CM19 5BY
Tel.: 0279/29666
Telex: 81387

Young Electronics Services
Beech House
Knaves Beech Estate
High Wycombe
Buckinghamshire
Tel: 0628 6531417
Fax: 0628 810823

FRANCE, PORTUGAL AND SPAIN**Distributors****France**

C.C.I.
5 Rue Marcelin Berthelot
92164 Anthony
Tel.: (1) 46662182
Telex: 203881
Fax: (1) 40969296

C.C.I.
67 Rue Bataille
69008 Lyon
Tel.: (16) 78744456
Telex: 375456
Fax: (16) 78760891

Mecodiis
3 Allee Des Erables
94042 Creteil Cedex
France
Tel: (1) 43-99-44-00
Fax: (1) 43-99-98-28
Tlx: 262-061

PEP
6-9 Rue Ambroise Croizat
91120 Palaiseau
Tel.: (1) 64470031
Telex: 603341
Fax: (1) 64470084

Silec Codicom
52 Quai Des Carrieres
94222 Charenton le Pont
Tel.: (1) 43/759592
Telex: 680363
Fax: (1) 48934414

Silec D.E.L.
8 Rue des Freres Bertranc
B.P. 59
69632 Venissieux Cedex
Tel.: (16) 78008697
Telex: 340189
Fax: (16) 78090291

PORTUGAL

Componenta
Rua Luis De Camoes 128
1300 Lisboa
Portugal
Tel: 351-1-36212-83/84
Fax: 351-1-363-76-55/Tlx: 61512

SPAIN

Amitron SA
Avda De Valladolid 47D
28008 Madrid
Spain
Tel: (91) 542-09-06/541-54-02
Fax: (91) 248-79-58
Tlx: 45550

Sutelco S.A.
Pilar de Zaragoza, 23
Madrid 02028/Spain
Tel.: 245-86-01
Telex: 43852
Fax: 245-8120

GENERAL INSTRUMENT INTERNATIONAL SALES OFFICES

**OTHER COUNTRIES
FOR COUNTRIES NOT INDICATED**

General Instrument Agencies
Freischutzstr. 96
8000 Munchen 81
Tel.: 089/95997-0
Telex: 5-24523
Fax: 089/9570489

AUSTRIA

Elbatek GmbH
Eitnergasse 6
1-1232 Wien
Tel.: 0222/863211
Telex: 1-133128
Fax: 0222/8652142

BELGIUM/HOLLAND

Rodelco B.V. Electronics
P.O. Box 6824
4802 HV Breda, Holland
Tel.: 076/784911
Telex: 54195
Fax: 076/710029

Lemaire Rodelco
Limburg-Stirumlaan 243
1810 Wommel/Belgium
Tel.: 02/4600560
Telex: 24610
Fax: 02/4600271

DENMARK

A/S Nordisk Elektronik
Transformervej, 17
DK-2730 Herlev
Tel.: 042/842000
Telex: 35200
Fax: 044/921552

FINLAND

Komdel OY
PL 52
SF-02211 Espoo 21
Tel.: (90) 885011
Telex: 121926
Fax: 90/885327

ISRAEL

SMD Electronics
P.O. Box 3075
Netanya 42130
Tel.: 053/616243
Fax: 053/620935

NORWAY

Nordisk Elektronik A/S
P.O. Box 130
1364 Hvalstad
Tel.: 02/846210
Telex: 17546
Fax: 02/846545

SOUTH AFRICA

Plessey South Africa Ltd.
Components Division
P.O. Box 8174
Elandsfontein 1406
Tel.: 011/8232950
Telex: 431421
Fax: 011/8232818

SWEDEN

Bexab Technology AB
Box 523
S-18325 Taby
Tel.: 08/7680560
Telex: 10912
Fax: 08/7581929

SWITZERLAND

Elbatex AG
Hardstr. 72
CH-5430 Wettingen
Tel.: 056/275111
Telex: 58068
Fax: 056/271924

HONG KONG

Astec Agencies Ltd.
Rm 2004 Nam Fung Centre
264-298 Castle Peak Road
Tsuen Wan, N.T. Hong Kong
Tel: 852-4155818
Fax: 852-4155742
Tlx: 37528 ASAG HX

INDIA

A.T.E. Enterprises Ltd.
36 SDF II, Seepz, Andheri(E)
Bombay 400 096, India
Tel: (022) 6349032/6300195
Tlx: (011) 79080 DIPIN

KOREA

Olympia Commercial Co., Ltd.
Rm 2A, Shinbong Bldg.
835-6, Yuksamdong, Kangnam-Ku
Seoul, Korea
Tel: 82-2-5673362
Fax: 82-2-5527036

SINGAPORE

B.B.S. Electronics PTE. Ltd.
1 Genting Link
#05-03 Perfect Industrial Bldg
Singapore 1334
Tel: 65-7488400
Fax: 65-7488466
Tlx: RS55510 BBSEL

TAIWAN

Tekfield Enterprise Co., Ltd.
12F-3, No. 271, SEC. 3, Roosevelt Road
Taipei, Taiwan, R.O.C.
Tel: 886-2-3623153/3629664
Fax: 886-2-3623476

Wei Keng Ind., Co., Ltd.
Rm B2, Fl 7, No 126 Sec 4
Nanking E. Road
Taipei, Taiwan R.O.C.
Tel: 886-2-7763512
Fax: 886-2-7519366
Tlx: 29463 WEKIND

**GENERAL
INSTRUMENT**

**AUTHORIZED
NATIONAL AND REGIONAL
DISTRIBUTOR HEADQUARTERS**

DISTRIBUTOR	ADDRESS	CITY/STATE	TELEPHONE NO.
ACI Electronics	200 Newton Road	Plainview, NY 11803	(516) 293-6630
Advent Electronics	7110 Lyndon Street	Rosemont, IL 60018	(708) 298-4210
All American Transistor	16251 N.W. 54th Avenue	Miami, FL 33041	(305) 621-8282
Almo Electronics	5417 E. LaPalma Avenue	Anaheim, CA 92807	(714) 777-4711
Arrow Electronics	25 Hub Drive	Melville, NY 11746	(516) 694-6800
Bell Industries	11812 San Vicente, Suite 300	Los Angeles, CA 90049	(213) 826-6778
Future Electronics	237 Hymus Boulevard	Pointe Claire, CN H9R5C7	(514) 694-7710
Hallmark Electronics	11333 Pagemill Road	Dallas, TX 75243-8399	(214) 343-5000
Hammond Electronics	1230 W. Central Avenue	Orlando, FL 32805	(407) 849-6060
Jaco Electronics	145 Oser Avenue	Hauppauge, NY 11788	(516) 273-5500
Marshall Industries	9674 Telstar Avenue	El Monte, CA 91731-3004	(818) 459-5500
Nu Horizons Electronics	6000 New Horizons Blvd.	Amityville, NY 11701	(516) 226-6000
Pioneer/Washington	9100 Gaither Road	Gaithersburg, MD 20877	(301) 921-0660
Pioneer/Cleveland	4800 E. 131st Street	Cleveland, OH 44105	(216) 587-3600
Solid State	46 Ferrand Street	Bloomfield, NJ 07003	(201) 429-8700
Zeus Components	100 Midland Avenue	Port Chester, NY 10573	(914) 937-7400

NOTES

**GENERAL
INSTRUMENT**

NOTES

**GENERAL
INSTRUMENT**

GENERAL INSTRUMENT

POWER SEMICONDUCTOR DIVISION

Power Semiconductor Division Headquarters 600 West John Street, CS620, Hicksville, NY 11802-1620, (516) 933-3333
• TWX: 310-376-8690 • FAX: 516-933-3881

North Eastern Regional Sales Office: 120 Andrews Road, Hicksville, NY 11801-1702, (516) 933-3200 • TWX: 310-376-7238
• FAX: 516-433-4412

South Eastern Regional Sales Office: 6855 Jimmy Carter Blvd., Suite 2250, Norcross, GA 30071, (404) 446-1265
• TWX: 510-101-3222 • FAX: 404-446-1286

Central Regional Sales Office: 85 W. Algonquin Road, Suite 300, Arlington Hts., IL 60005, (708) 364-5880 • TWX: 910-222-0431
• FAX: 708-364-0649

Western Regional Sales Office: 21601 Vanowen Street, Suite 205, Canoga Park, CA 91303, (818) 992-0982
• TWX: 910-322-1980 • FAX: 818-992-1658

INTERNATIONAL SALES OFFICES

Germany, Austria and Switzerland General Instrument Deutschland GmbH, Freischützstraße 96, 8000 München 81, W. Germany, Tel: (0-89) 95997-0 • Telex: 524523 • FAX: 9-011-49-89-957-0489

France General Instrument France, 9/11 Rue G. Enesco, 94008 Creteil, Tel: 33 (1) 43771263 • Telex: 262435 • FAX: (33) 143991524

Italy General Instrument Italia S.R.L., Via Cantu 11-20092 Cinisello Balsamo, Milano, Tel: 02/66010274-66010285-66010287 • Telex: 320348 • FAX: 02/66010324

United Kingdom General Instrument (UK) Ltd., Power Semiconductor Div., Chelworth Industrial Estate, Cricklade, Swindon, Wiltshire, England SN6 6HQ • Tel: (0793) 752307 • FAX: (0793) 751419

Power Semiconductor Div.-Semitron Industries Ltd., Chelworth Industrial Estate, Cricklade, Swindon, Wiltshire, England SN6 6HQ
Tel: (0793) 751151 • FAX: (0793) 751808 • Telex: 44848

Taiwan General Instrument of Taiwan, Ltd., 233 Pao Chiao Road, Hsin Tien, Taipei, Taiwan, Tel: 9113860
• FAX: 9-011-8862-917-5991

Japan General Instrument Japan, Ltd., 5F4-1-13 Toranomon, Minato-Ku, Tokyo, Japan, 105 Tel: (03) 437-0281
• FAX: 9-011-81-3434-3938 (GIJ)

Hong Kong General Instrument Hong Kong Ltd., Rm. 1104-1107, Tower B, Mandarin Plaza, 14 Science Museum Road, Tsimshatsui East, Kowloon, Hong Kong, Tel: 3-7226577
• Telex: 54606 GIHKHX • FAX: (852) 3-7239239